

GENERAL SPECIFICATIONS

Electrical Capacity

Resistive Load: 15A & ½ HP @ 125 or 250V AC for high capacity models
Lamp Load: 5A @ 125V AC

Other Ratings

Contact Resistance: 15 milliohms maximum
Insulation Resistance: 100 megohms minimum @ 500V DC
Dielectric Strength: 1,000V AC minimum between contacts for 1 minute minimum;
 1,500V AC minimum between contacts & case for 1 minute minimum
Mechanical Life: 1,000,000 operations minimum
Electrical Life: 50,000 operations minimum
Travel: Pretravel .047" (1.19mm); Overtravel .040" (1.01mm); Differential .011" (0.27mm)
Operating Temp Range: -40°C through +85°C (-40°F through +185°F)

Materials & Finishes

Caps & Shrouds: Polycarbonate with glossy finish or PBT
Plunger: Polyacetal or brass with nickel plating
Bushing: Steel with zinc plating or glass fiber reinforced polyamide
Case: Polyester
Movable & Stationary Contacts: Silver alloy
Terminals: Brass with silver plating

Standards & Certifications

UL: Internal snap switch is UL recognized.
CSA: Internal snap switch is CSA certified.

TYPICAL SWITCH ORDERING EXAMPLE

SCB

2

5

P

15

A

—

4

CA

Poles	
1	SPDT
2	DPDT

Circuits		
5	ON	(ON)
6	ON	ON
() = Momentary		

Bushings	
P	Plastic (with momentary only)
S	Steel

Rating	
15	15A

Terminals	
A	.187" (4.75mm) Quick Connect
* B	.250" (6.35mm) Quick Connect
Note: Contact factory for availability of screw lug and solder lug models.	
* Available in Americas only	

Caps & Shrouds	
For Momentary	
3	.520" (13.2mm) Diameter Cap
For Momentary & Alternate Action	
4	Round Cap & Shroud (AT454 & AT455)
5	Rectangular Cap & Shroud (AT452 & AT453)

DESCRIPTION FOR TYPICAL ORDERING EXAMPLE

SCB25P15A-4CA

Colors		
	Caps	Shrouds
A	Black	A
B	White	B
C	Red	—
F	Green	—
G	Blue	—
H	Gray	H

Note: Standard hardware is provided with caps. See Bushing detail for more information.

Toggles
 Rockers
 Pushbuttons
 Illuminated PB
 Programmable
 Keylocks
 Rotaries
 Slides
 Tactiles
 Tilt
 Touch
 Indicators
 Accessories
 Supplement

Toggles

Rockers

Pushbuttons

Illuminated PB

Keylocks

Rotaries

Slides

Tactiles

Tilt





Touch

Indicators

Accessories

Supplement

POLES & CIRCUITS

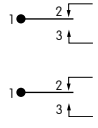
		Plunger Position () = Momentary		Connected Terminals		Throw & Schematics
Pole	Model	Normal  Keyway	Down 	Normal  Keyway	Down 	Note: Terminal numbers are actually on the switch.
SP	SCB15 SCB16	ON ON	(ON) ON	1-2	1-3	SPDT 
DP	SCB25 SCB26	ON ON	(ON) ON	1-2 1-2	1-3 1-3	SP with 2 switches 

BUSHINGS

P Plastic
(for Momentary only)

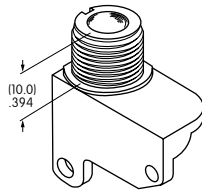

S Steel

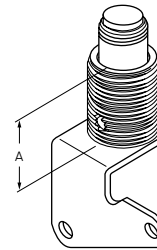

"A" =
11.2mm
Momentary
15.5mm
Alternate Action

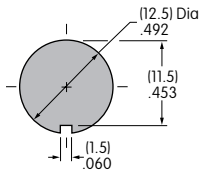

Maximum Effective Panel Thickness:
.165" (4.2mm) without Shroud
.157" (4.0mm) with Shroud

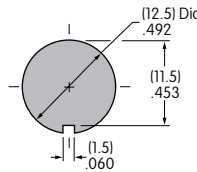

Maximum Effective Panel Thickness:
Momentary: .177" (4.5mm) without Shroud
.157" (4.0mm) with Shroud
Alternate Action: .354" (9.0mm)

Standard Hardware Provided with Caps

Cap Option 3: AT504M Knurled Face Nut, AT508 Lockwasher, AT527M Hex Mounting Nut

Cap Options 4 & 5: AT508 Lockwasher & AT527M Hex Mounting Nut

TERMINALS

A .187" (4.75mm)
Quick Connect

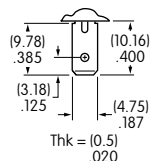

B .250" (6.35mm)
Quick Connect

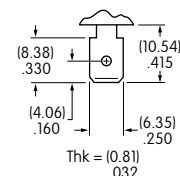

TYPICAL SWITCH DIMENSIONS

.520" (13.2mm) Dia. Cap • .187" (4.75mm) Quick Connect

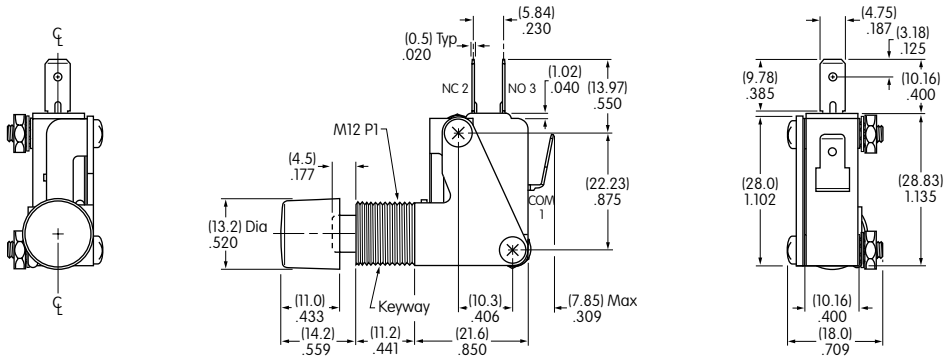

SCB15S15A-3C

Round Cap & Shroud • .187" (4.75mm) Quick Connect

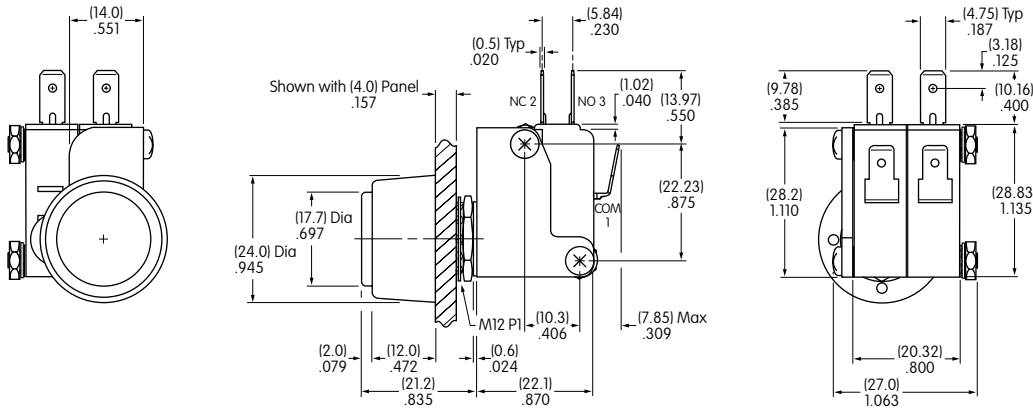

SCB25P15A-4CA

Rectangular Cap & Shroud • .250" (6.35mm) Quick Connect

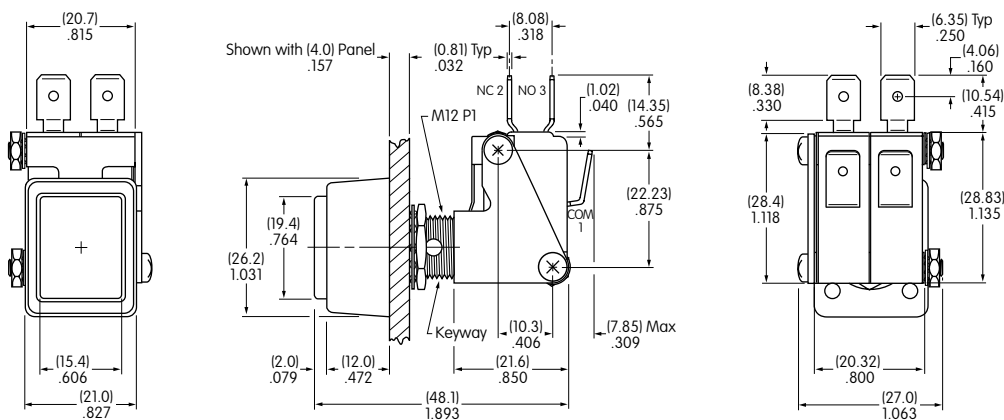

SCB26S15B-5CA



Компания «ЭлектроПласт» предлагает заключение долгосрочных отношений при поставках импортных электронных компонентов на взаимовыгодных условиях!

Наши преимущества:

- Оперативные поставки широкого спектра электронных компонентов отечественного и импортного производства напрямую от производителей и с крупнейших мировых складов;
- Поставка более 17-ти миллионов наименований электронных компонентов;
- Поставка сложных, дефицитных, либо снятых с производства позиций;
- Оперативные сроки поставки под заказ (от 5 рабочих дней);
- Экспресс доставка в любую точку России;
- Техническая поддержка проекта, помощь в подборе аналогов, поставка прототипов;
- Система менеджмента качества сертифицирована по Международному стандарту ISO 9001;
- Лицензия ФСБ на осуществление работ с использованием сведений, составляющих государственную тайну;
- Поставка специализированных компонентов (Xilinx, Altera, Analog Devices, Intersil, Interpoint, Microsemi, Aeroflex, Peregrine, Syfer, Eurofarad, Texas Instrument, Miteq, Cobham, E2V, MA-COM, Hittite, Mini-Circuits, General Dynamics и др.);

Помимо этого, одним из направлений компании «ЭлектроПласт» является направление «Источники питания». Мы предлагаем Вам помощь Конструкторского отдела:

- Подбор оптимального решения, техническое обоснование при выборе компонента;
- Подбор аналогов;
- Консультации по применению компонента;
- Поставка образцов и прототипов;
- Техническая поддержка проекта;
- Защита от снятия компонента с производства.



Как с нами связаться

Телефон: 8 (812) 309 58 32 (многоканальный)

Факс: 8 (812) 320-02-42

Электронная почта: org@eplast1.ru

Адрес: 198099, г. Санкт-Петербург, ул. Калинина, дом 2, корпус 4, литера А.