

## GENERAL SPECIFICATIONS

### Electrical Capacity

**Resistive Load:** 15A & ½ HP @ 125 or 250V AC for high capacity models  
**Lamp Load:** 5A @ 125V AC

### Other Ratings

**Contact Resistance:** 15 milliohms maximum  
**Insulation Resistance:** 100 megohms minimum @ 500V DC  
**Dielectric Strength:** 1,000V AC minimum between contacts for 1 minute minimum;  
 1,500V AC minimum between contacts & case for 1 minute minimum  
**Mechanical Life:** 1,000,000 operations minimum  
**Electrical Life:** 50,000 operations minimum  
**Travel:** Pretravel .047" (1.19mm); Overtravel .040" (1.01mm); Differential .011" (0.27mm)  
**Operating Temp Range:** -40°C through +85°C (-40°F through +185°F)

### Materials & Finishes

**Caps & Shrouds:** Polycarbonate with glossy finish or PBT  
**Plunger:** Polyacetal or brass with nickel plating  
**Bushing:** Steel with zinc plating or glass fiber reinforced polyamide  
**Case:** Polyester  
**Movable & Stationary Contacts:** Silver alloy  
**Terminals:** Brass with silver plating

### Standards & Certifications

**UL:** Internal snap switch is UL recognized.  
**CSA:** Internal snap switch is CSA certified.

## TYPICAL SWITCH ORDERING EXAMPLE

SCB

2

5

P

15

A

—

4

CA

**Poles**

1	SPDT
2	DPDT

**Circuits**

5	ON	(ON)
6	ON	ON

( ) = Momentary

**Bushings**

P	Plastic (with momentary only)
S	Steel

**Rating**

15	15A
----	-----

**Terminals**

A	.187" (4.75mm) Quick Connect
* B	.250" (6.35mm) Quick Connect

Note: Contact factory for availability of screw lug and solder lug models.  
 \* Available in Americas only

**Caps & Shrouds**

**For Momentary**

3	.520" (13.2mm) Diameter Cap
---	-----------------------------

**For Momentary & Alternate Action**

4	Round Cap & Shroud (AT454 & AT455)
5	Rectangular Cap & Shroud (AT452 & AT453)

**DESCRIPTION FOR TYPICAL ORDERING EXAMPLE**

SCB25P15A-4CA

DPDT ON-(ON) Circuit

15A Rating

Round Red Cap with Black Shroud

Plastic Bushing

.187" (4.75mm) Quick Connect Terminals

**Colors**

Caps		Shrouds	
A	Black	A	
B	White	B	
C	Red	—	
F	Green	—	
G	Blue	—	
H	Gray	H	

Note: Standard hardware is provided with caps. See Bushing detail for more information.

Toggles  
 Rockers  
 Pushbuttons  
 Illuminated PB  
 Programmable  
 Keylocks  
 Rotaries  
 Slides  
 Tactiles  
 Tilt  
 Touch  
 Indicators  
 Accessories  
 Supplement

Toggles

Rockers

Pushbuttons

Illuminated PB

Keylocks

Rotaries

Slides

Tactiles

Tilt





Touch

Indicators

Accessories

Supplement

## POLES & CIRCUITS

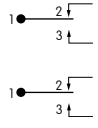
		Plunger Position ( ) = Momentary		Connected Terminals		Throw & Schematics
Pole	Model	Normal  Keyway	Down 	Normal  Keyway	Down 	Note: Terminal numbers are actually on the switch.
SP	SCB15 SCB16	ON ON	(ON) ON	1-2	1-3	
DP	SCB25 SCB26	ON ON	(ON) ON	1-2 1-2	1-3 1-3	SP with 2 switches 

## BUSHINGS

**P** Plastic  
(for Momentary only)

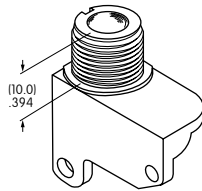

**S** Steel

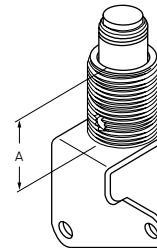

"A" =  
11.2mm  
Momentary  
15.5mm  
Alternate Action

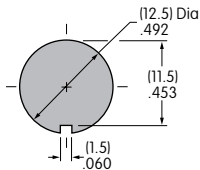

Maximum Effective Panel Thickness:  
.165" (4.2mm) without Shroud  
.157" (4.0mm) with Shroud

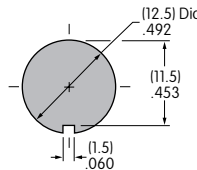

Maximum Effective Panel Thickness:  
Momentary: .177" (4.5mm) without Shroud  
.157" (4.0mm) with Shroud  
Alternate Action: .354" (9.0mm)

### Standard Hardware Provided with Caps

Cap Option 3: AT504M Knurled Face Nut, AT508 Lockwasher, AT527M Hex Mounting Nut

Cap Options 4 & 5: AT508 Lockwasher & AT527M Hex Mounting Nut

## TERMINALS

**A** .187" (4.75mm)  
Quick Connect

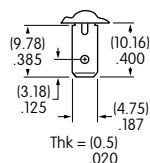

**B** .250" (6.35mm)  
Quick Connect

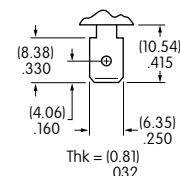

## TYPICAL SWITCH DIMENSIONS

**.520" (13.2mm) Dia. Cap • .187" (4.75mm) Quick Connect**

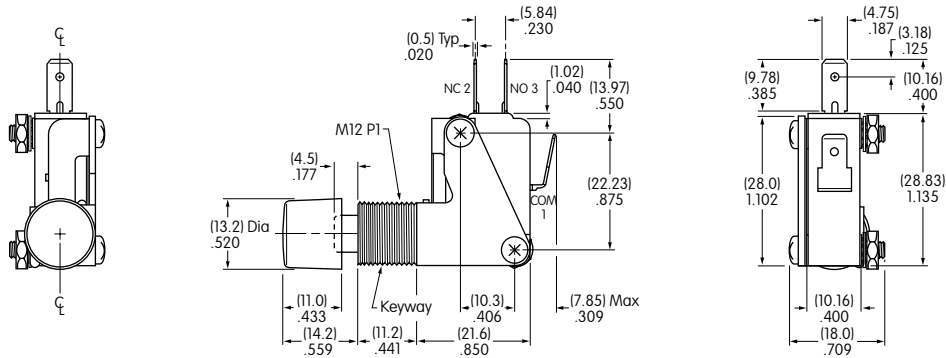

**SCB15S15A-3C**

**Round Cap & Shroud • .187" (4.75mm) Quick Connect**

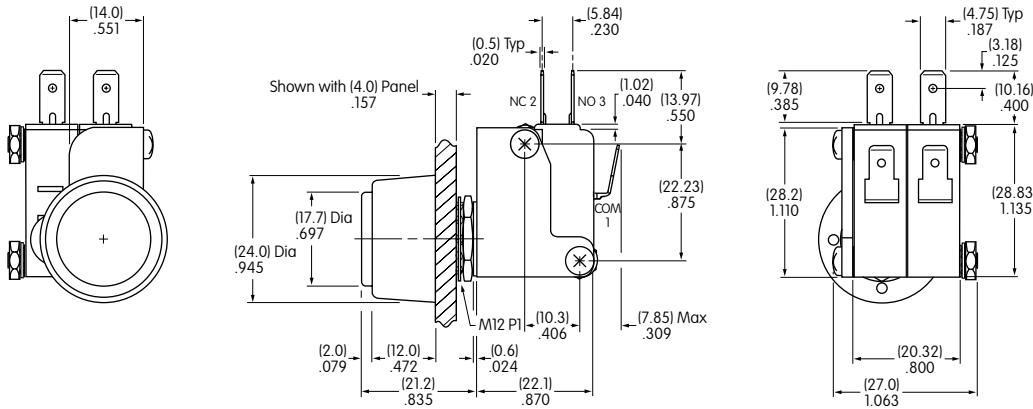

**SCB25P15A-4CA**

**Rectangular Cap & Shroud • .250" (6.35mm) Quick Connect**

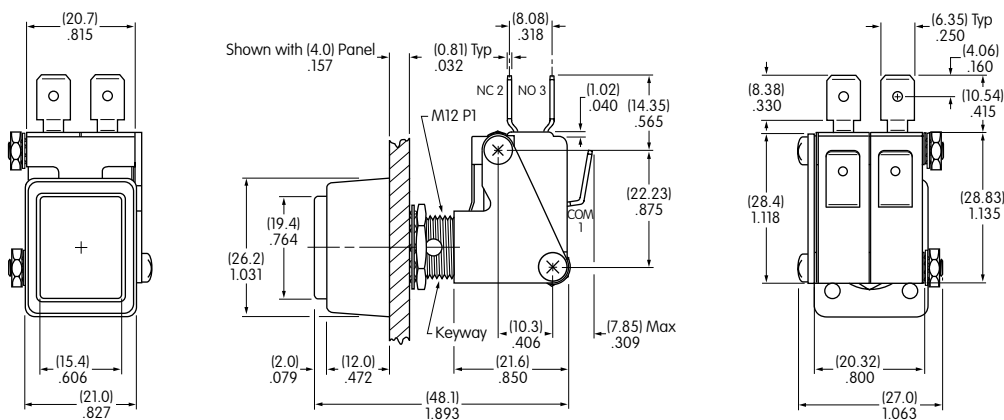

**SCB26S15B-5CA**



Компания «ЭлектроПласт» предлагает заключение долгосрочных отношений при поставках импортных электронных компонентов на взаимовыгодных условиях!

Наши преимущества:

- Оперативные поставки широкого спектра электронных компонентов отечественного и импортного производства напрямую от производителей и с крупнейших мировых складов;
- Поставка более 17-ти миллионов наименований электронных компонентов;
- Поставка сложных, дефицитных, либо снятых с производства позиций;
- Оперативные сроки поставки под заказ (от 5 рабочих дней);
- Экспресс доставка в любую точку России;
- Техническая поддержка проекта, помощь в подборе аналогов, поставка прототипов;
- Система менеджмента качества сертифицирована по Международному стандарту ISO 9001;
- Лицензия ФСБ на осуществление работ с использованием сведений, составляющих государственную тайну;
- Поставка специализированных компонентов (Xilinx, Altera, Analog Devices, Intersil, Interpoint, Microsemi, Aeroflex, Peregrine, Syfer, Eurofarad, Texas Instrument, Miteq, Cobham, E2V, MA-COM, Hittite, Mini-Circuits, General Dynamics и др.);

Помимо этого, одним из направлений компании «ЭлектроПласт» является направление «Источники питания». Мы предлагаем Вам помощь Конструкторского отдела:

- Подбор оптимального решения, техническое обоснование при выборе компонента;
- Подбор аналогов;
- Консультации по применению компонента;
- Поставка образцов и прототипов;
- Техническая поддержка проекта;
- Защита от снятия компонента с производства.



#### Как с нами связаться

**Телефон:** 8 (812) 309 58 32 (многоканальный)

**Факс:** 8 (812) 320-02-42

**Электронная почта:** [org@eplast1.ru](mailto:org@eplast1.ru)

**Адрес:** 198099, г. Санкт-Петербург, ул. Калинина, дом 2, корпус 4, литера А.