

For FPC	<h1>Y3B/Y3BW</h1> Series
<b>FPC connectors (0.3mm pitch) Back lock</b>	

### FEATURES

**1. Slim (short width 3.15 mm) and low profile design**  
Back lock type and the slim body with a 3.15 mm depth (with the lever).

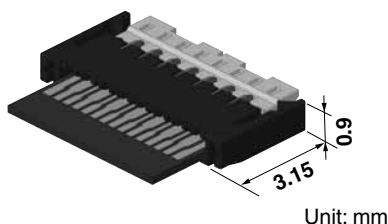

**2. Mechanical design freedom is achieved with double top and bottom contacts**

Top and bottom double contacts eliminate the need of using different connectors (with either top or bottom contacts) depending on the FPC wiring conditions.

**3. Easy-to-handle back lock structure**  
**4. Man-hours of assembly time can be reduced by delivering the connectors with their levers opened.**

**5. Wiring patterns can be placed underneath the connector.**

**6. Ni barrier with high resistance to solder creepage**

**7. Y3BW features lock holding type, including a structure to temporarily hold the FPC and a higher holding force.**

The FPC holding contacts located on both ends of the connector facilitate positioning of FPC and further enhance the FPC holding force.

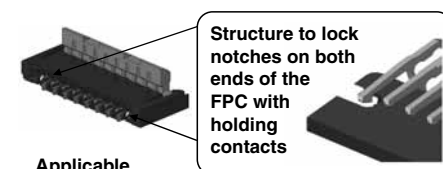

Applicable FPC shapes

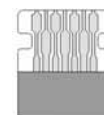

(1) The inserted FPC can be temporarily held until the lever is closed.

(2) When the lever is closed, the holding contacts lock the FPC by its notches, enhancing the FPC holding force.

### APPLICATIONS

Mobile devices, such as cellular phones, smartphones, digital still cameras and digital video cameras.



RoHS compliant

### ORDERING INFORMATION

AYF 3 3 [ ] [ ] [ ] 5

33: FPC Connector 0.3 mm pitch  
(Back lock)

Number of pins (2 digits)

Function

3: Top and bottom double contacts (Y3B)

6: Top and bottom double contacts, lock holding type (Y3BW)

Surface treatment (Contact portion / Terminal portion)

5: Au plating/Au plating (Ni barrier)

## PRODUCT TYPES

### Y3B

Height	Number of pins	Part number	Packing	
			Inner carton	Outer carton
0.9 mm	7	AYF330735	5,000 pieces	10,000 pieces
	8	AYF330835		
	9	AYF330935		
	11	AYF331135		
	13	AYF331335		
	15	AYF331535		
	17	AYF331735		
	21	AYF332135		
	23	AYF332335		
	25	AYF332535		
	27	AYF332735		
	31	AYF333135		
	33	AYF333335		
	35	AYF333535		
	37	AYF333735		
	39	AYF333935		
	41	AYF334135		
	45	AYF334535		
51	AYF335135			
61	AYF336135			
71	AYF337135			

### Y3BW

Height	Number of pins	Part number	Packing	
			Inner carton (1-reel)	Outer carton
0.9 mm	11	AYF331165	5,000 pieces	10,000 pieces
	25	AYF332565		
	51	AYF335165		

Notes: 1. Order unit; For volume production: 1-inner carton (1-reel) units.

Samples for mounting check: 50-connector units. Please contact our sales office.

Samples: Small lot orders are possible. Please contact our sales office.

2. Please contact our sales office for connectors having a number of pins other than those listed above.

# SPECIFICATIONS

## 1. Characteristics: When using an applicable FPC (thickness 0.20 mm)

Item	Specifications	Conditions																			
Electrical characteristics	Rated current	0.2A/pin contact																			
	Rated voltage	50V AC/DC																			
	Insulation resistance	Min. 1,000M $\Omega$ (initial)	Using 250V DC megger (applied for 1 min.)																		
	Breakdown voltage	150V AC for 1 min.	No short-circuiting or damage at a detection current of 1 mA when the specified voltage is applied for one minute.																		
	Contact resistance	Max. 100m $\Omega$	Based on the contact resistance measurement method specified by JIS C 5402.																		
Mechanical characteristics	FPC holding force	Y3B: Min. 0.13N/pin contact $\times$ pin contacts (initial) Y3BW: Min. 0.13N/pin contact $\times$ pin contacts + 1.00N (initial)	Measurement of the maximum force applied until the inserted compatible FPC is pulled out in the insertion axis direction while the connector lever is closed																		
Environmental characteristics	Ambient temperature	-55°C to +85°C	No freezing at low temperatures. No dew condensation.																		
	Storage temperature	-55°C to +85°C (product only) -40°C to +50°C (emboss packing)																			
	Thermal shock resistance (with FPC mated)	5 cycles, insulation resistance min. 100M $\Omega$ , contact resistance max. 100m $\Omega$	Conformed to MIL-STD-202F, method 107G <table border="1"> <thead> <tr> <th>Order</th> <th>Temperature (°C)</th> <th>Time (minutes)</th> </tr> </thead> <tbody> <tr> <td>1</td> <td>-55<math>\frac{0}{-3}</math></td> <td>30</td> </tr> <tr> <td>2</td> <td>}</td> <td>Max. 5</td> </tr> <tr> <td>3</td> <td>85<math>\frac{+3}{0}</math></td> <td>30</td> </tr> <tr> <td>4</td> <td>}</td> <td>Max. 5</td> </tr> <tr> <td></td> <td>-55<math>\frac{0}{-3}</math></td> <td></td> </tr> </tbody> </table>	Order	Temperature (°C)	Time (minutes)	1	-55 $\frac{0}{-3}$	30	2	}	Max. 5	3	85 $\frac{+3}{0}$	30	4	}	Max. 5		-55 $\frac{0}{-3}$	
	Order	Temperature (°C)	Time (minutes)																		
	1	-55 $\frac{0}{-3}$	30																		
	2	}	Max. 5																		
	3	85 $\frac{+3}{0}$	30																		
4	}	Max. 5																			
	-55 $\frac{0}{-3}$																				
Humidity resistance (with FPC mated)	120 hours, insulation resistance min. 100M $\Omega$ , contact resistance max. 100m $\Omega$	Bath temperature 40 $\pm$ 2°C, humidity 90 to 95% R.H.																			
Saltwater spray resistance (with FPC mated)	24 hours, insulation resistance min. 100M $\Omega$ , contact resistance max. 100m $\Omega$	Bath temperature 35 $\pm$ 2°C, saltwater concentration 5 $\pm$ 1%																			
H <sub>2</sub> S resistance (with FPC mated)	48 hours, contact resistance max. 100m $\Omega$	Bath temperature 40 $\pm$ 2°C, gas concentration 3 $\pm$ 1 ppm, humidity 75 to 80% R.H.																			
Soldering heat resistance	Peak temperature: 260°C or less	Reflow soldering																			
	300°C within 5 sec. 350°C within 3 sec.	Soldering iron																			
Lifetime characteristics	Insertion and removal life	20 times	Repeated insertion and removal: min. 10 sec./time																		
Unit weight	Y3B: 61 pin contacts: 0.10 g Y3BW: 51 pin contacts: 0.09 g																				

## 2. Material and surface treatment

Part name	Material	Surface treatment
Molded portion	Housing: LCP resin (UL94V-0) Lever: LCP resin (UL94V-0)	—
Contact	Copper alloy	Contact portion; Base: Ni plating, Surface: Au plating Terminal portion; Base: Ni plating, Surface: Au plating
Holding contact (Only Y3BW)	Copper alloy	Contact portion; Base: Ni plating, Surface: Au plating

## DIMENSIONS (Unit: mm)

The CAD data of the products with a **CAD Data** mark can be downloaded from: <http://industrial.panasonic.com/ac/e/>

### Y3B

#### No. of pins: Odd number **CAD Data**



Number of pins/ dimension	A	B	C
7	3.60	1.80	1.20
9	4.20	2.40	1.80
11	4.80	3.00	2.40
13	5.40	3.60	3.00
15	6.00	4.20	3.60
17	6.60	4.80	4.20
21	7.80	6.00	5.40
23	8.40	6.60	6.00
25	9.00	7.20	6.60
27	9.60	7.80	7.20
31	10.80	9.00	8.40
33	11.40	9.60	9.00
35	12.00	10.20	9.60
37	12.60	10.80	10.20
39	13.20	11.40	10.80
41	13.80	12.00	11.40
45	15.00	13.20	12.60
51	16.80	15.00	14.40
61	19.80	18.00	17.40
71	22.80	21.00	20.40

#### No. of pins: Even number (8 pin contacts) **CAD Data**



General tolerance:  $\pm 0.3$

Each mentioned sizes are at the stage of initial delivery.

# RECOMMENDED FPC DIMENSIONS

## Y3B

(Finished thickness:  $t = 0.2 \pm 0.03$ )

The conductive parts should be based by Ni plating and then Au plating.

### No. of pins: Odd number



Number of pins/ dimension	A	B	C
7	2.40	1.80	1.20
9	3.00	2.40	1.80
11	3.60	3.00	2.40
13	4.20	3.60	3.00
15	4.80	4.20	3.60
17	5.40	4.80	4.20
21	6.60	6.00	5.40
23	7.20	6.60	6.00
25	7.80	7.20	6.60
27	8.40	7.80	7.20
31	9.60	9.00	8.40
33	10.20	9.60	9.00
35	10.80	10.20	9.60
37	11.40	10.80	10.20
39	12.00	11.40	10.80
41	12.60	12.00	11.40
45	13.80	13.20	12.60
51	15.60	15.00	14.40
61	18.60	18.00	17.40
71	21.60	21.00	20.40

### No. of pins: Even number (8 pin contacts)

For Top Contacts

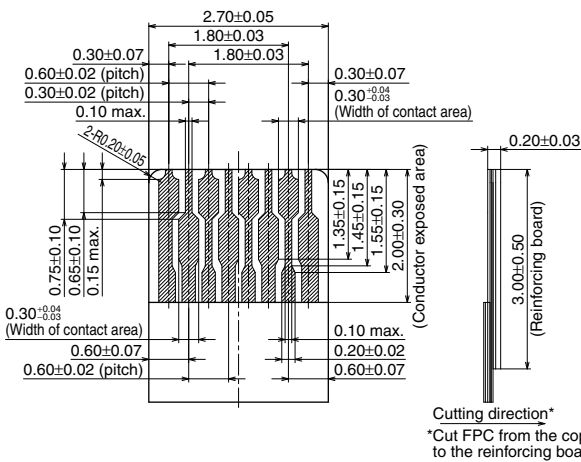

For Bottom Contacts



**DIMENSIONS** (Unit: mm)  
**Y3BW**

The CAD data of the products with a **CAD Data** mark can be downloaded from: <http://industrial.panasonic.com/ac/e/>

**CAD Data**

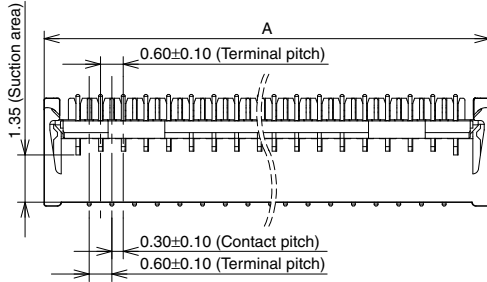

Holding contacts  
 (The holding contacts cannot be used as conductors.)

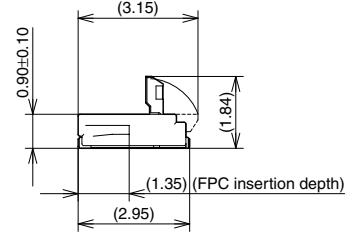
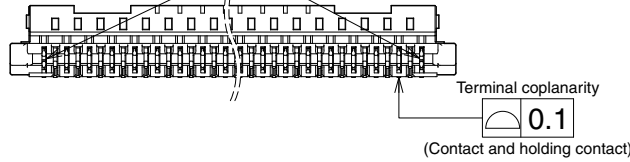

General tolerance: ±0.3

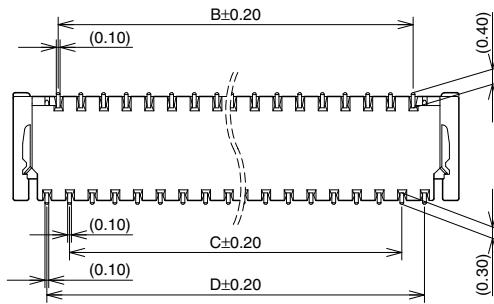

Number of pins/ dimension	A	B	C	D
11	5.40	3.00	2.40	3.60
25	9.60	7.20	6.60	7.80
51	17.40	15.00	14.40	15.60

**RECOMMENDED FPC DIMENSIONS**  
**Y3BW**

(Finished thickness:  $t = 0.2 \pm 0.03$ )

The conductive parts should be based by Ni plating and then Au plating.

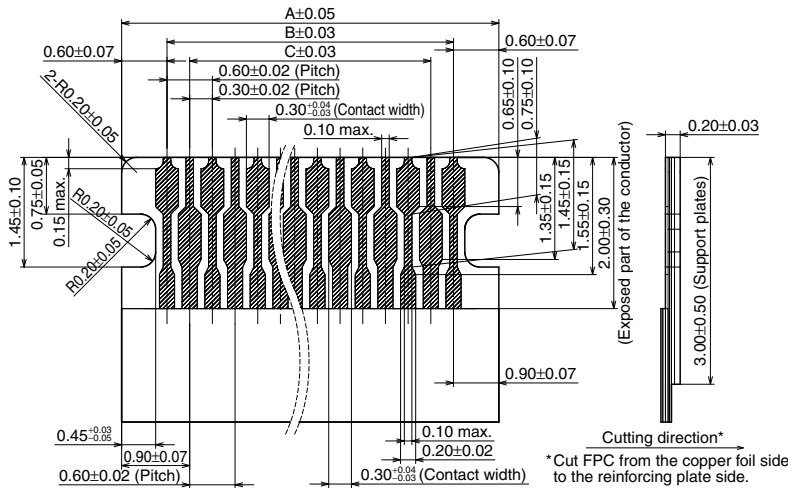

Number of pins/ dimension	A	B	C
11	4.20	3.00	2.40
25	8.40	7.20	6.60
51	16.20	15.00	14.40

# EMBOSSED TAPE DIMENSIONS (Unit: mm) (Common for respective contact type)

• Specifications for taping



• Specifications for the plastic reel (In accordance with EIAJ ET-7200B.)



• Y3B Dimension table (Unit: mm)

Number of pins	Type of taping	A	B	C	Quantity per reel
7 to 17	Tape I	16.0	7.5	17.4	5,000
21 to 45	Tape I	24.0	11.5	25.4	5,000
51, 61	Tape II	32.0	14.2	33.4	5,000
71	Tape II	44.0	20.2	45.4	5,000

• Y3BW Dimension table (Unit: mm)

Number of pins	Type of taping	A	B	C	Quantity per reel
11	Tape I	16.0	7.5	17.4	5,000
25	Tape I	24.0	11.5	25.4	5,000
51	Tape II	32.0	14.2	33.4	5,000

• Connector orientation with respect to embossed tape feeding direction



## NOTES

1. Recommended PC board and metal mask patterns

Connectors are mounted with high pitch density, intervals of contact pitch 0.4 mm, 0.5 mm or 0.6 mm.

In order to reduce solder and flux rise, solder bridges and other issues make sure the proper levels of solder is used. The figures to the right are recommended metal mask patterns. Please use our recommended patterns basically.

• Y3B  
No. of pins: Odd number

Recommended PC board pattern (mounting layout) (TOP VIEW)



Recommended metal mask pattern  
Metal mask thickness: When 120µm  
(Front terminal portion opening area ratio: 96%)  
(Back terminal portion opening area ratio: 96%)



No. of pins: Even number  
(8 pin contacts)

Recommended PC board pattern (mounting layout) (TOP VIEW)



Recommended metal mask pattern  
Metal mask thickness: When 120µm  
(Front terminal portion opening area ratio: 96%)  
(Back terminal portion opening area ratio: 96%)



•Y3BW

Recommended PC board pattern  
(mounting layout)  
(TOP VIEW)



Please refer to the latest product specifications when designing your product.

Recommended metal mask pattern

Metal mask thickness: When  $120\mu\text{m}$   
(Front terminal portion opening area ratio: 96%)  
(Back terminal portion opening area ratio: 96%)

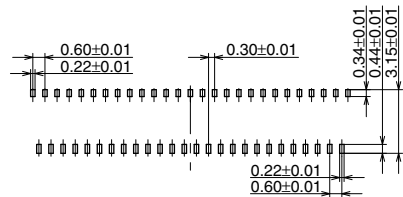



# Notes on Using FPC Connectors

## ■ PC board design

- Design the recommended foot pattern in order to secure the mechanical strength in the soldered areas of the terminal.
- In order to facilitate the connector mount, make sure to design the board with reduced warpage.
- Please design and pay attention to the distance from the board edge to the pattern. When cutting the board, do not give an excessive stress to the connector, which risks damaging the connector.

## (Y3BW/Y5BW)

- Depending on FPC dimension and FPC insertion location, there is a possibility that the holding contact and an FPC pattern of both end of signal contacts are in short-circuited. Please design the equipment not to be affected even if a board pattern of holding contacts and an FPC pattern of both end of signal contacts are in short-circuited. (For example: Do not connect a board pattern of holding contacts and GND. If connect a board pattern of holding contacts and GND, also connect board pattern of both end of signal contacts.)

## ■ FPC and equipment design

- Design the FPC based with recommended dimensions to ensure the required connector performance.
- When using back lock type, secure enough space for closing the lever and for open-close operation of the lever.
- Make sure that connector positioning and FPC length are appropriate to prevent diagonal insertion of the FPC.
- Due to the FPC size, weight, or the reaction force of the routed FPC, FPC removed and connector deformation may occur by a fall, vibration, or other impact. Carefully check the equipment design and take required measures to prevent the FPC removed.
- If the shock of falling, vibration is applied to the FPC, please design the equipment not to be applied a load to connector, such as fixing the FPC.
- Make sure to design the FPC insertion part with reduced warpage. Otherwise, the warpage may adversely affect the FPC insertion.

## (Y3BW/Y5BW)

### ■ The holding contacts cannot be used as conductors.

The holding contacts are located on both ends of the connector, and the shape of the soldered portions is the same as that of the signal contacts. Use caution to ensure connect identification.

## (Y3BL)

### ■ Soldering terminal structure

Since soldering terminals touch FPC, note that the short circuit may occur when the metal parts exposed on side of FPC.

- Depending on FPC dimension, there is a possibility that soldering terminals and an FPC pattern of both end of signal contacts are in short-circuited. Please design the equipment not to be affected even if a board pattern of soldering terminals and an FPC pattern of both end of signal contacts are in short-circuited. (For example: Do not connect a board pattern of soldering terminals and GND. If connect a board pattern of soldering terminals and GND, also connect board pattern of both end of signal contacts.)

## ■ Connector mounting

Excessive mounter chucking force may deform the molded or metal part of the connector. Consult us in advance if chucking is to be applied.

## ■ Soldering

### 1) Manual soldering

- Due to the connector's compact size, if an excessive amount of solder is applied during manual soldering, the solder may creep up and flux wicking near the contact points, or solder interference may cause impact contact.
- Make sure that the soldering iron tip is heated within the temperature and time limits indicated in the specifications.
- Flux from the solder wire may adhere to the contact surfaces during soldering operations. After soldering, carefully check the contact surfaces and cleans off any flux solder use.
- Be aware that a load applied to the connector terminals while soldering may displace the contact.
- Thoroughly clean the iron tip.

### 2) Reflow soldering

- Screen-printing is recommended for printing paste solder.
- To achieve the appropriate soldering state, make sure that the reflow temperature, PC board foot pattern, window size and thickness of metal mask are recommended condition.
- Note that excess solder on the terminals prevents complete insertion of the FPC, and causes flux climbing up.
- A screen thickness of 120 $\mu$ m is recommended during cream solder printing.
- Consult us when using a screen-printing thickness other than that recommended.
- Depending on the size of the connector being used, self alignment may not be possible. Accordingly, carefully position the terminal with the PC board pattern.
- The recommended reflow temperature profile is given in the figure below.

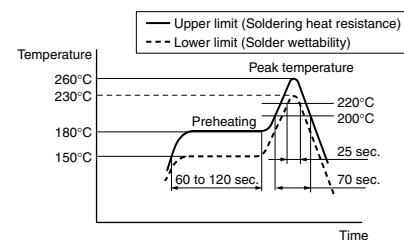

- The temperature is measured on the surface of the PC board near the connector terminals.
- Depending on reflow condition, poor contact may occur by solder and flux wicking. Please set the reflow conditions that considering the characteristics of solder and flux. Also please make consideration in setting the reflow times and O<sub>2</sub> concentration to prevent poor contact by solder and flux wicking.
- When performing reflow soldering on the back of the PC board after reflow soldering the connector, secure the connector using, for example, an adhesive. (Double reflow soldering on the same side is possible.) Do not touch the lever or apply any load to the lever until the second reflow soldering. The terminals may be deformed by reflow heating, because if touching or applying any load to the lever, contact deflection occurs.

# Notes on Using FPC Connectors

## 3) Reworking on a soldered portion

- Finish reworking in one operation.
- For reworking of the solder bridge, use a soldering iron with a flat tip.

Do not add flux, otherwise the flux may creep to the contact parts.

When adding the solder for reworking, do not add an excessive solder. Otherwise, solder and flux may creep up and solder bridges may occur.

- Use a soldering iron whose tip temperature is within the temperature range specified in the specifications.

■ **Do not drop or handle the connector carelessly. Otherwise, the terminals may become deformed due to excessive force or applied solderability may be during reflow degrade.**

■ **Do not open/close the lever or insert/remove an FPC until the connector is soldered. Forcibly applied external pressure on the terminals can weaken the adherence of the terminals to the molded part or cause the terminals to lose their evenness. In addition, do not insert an FPC into the connector before soldering the connector.**

■ **When cutting or bending the PC board after mounting the connector, be careful that the soldered sections are subjected to excessive force.**



## ■ Precautions for insertion/removal of FPC

### <Back-Lock>

- Avoid touching the lever (applying any external force) until an FPC is inserted.
- Do not open/close the lever without an FPC inserted. Failure to follow this instruction will cause the contacts to warp, leading to the contact tips to interfere with the insertion of an FPC, deforming the terminals. Failure to follow this instruction may cause the lever to be removed, terminals to be deformed, and/or the FPC insertion force to increase.



- In the case of Back-lock type, the FPC insertion section is on the opposite side of the lever.
- Be careful not to make a mistake in the FPC insertion position or the lever opening/closing position. Otherwise, a contact failure or connector breakage may occur.
- Do not insert an FPC upside down. Inserting an FPC in a direction opposite to that you intended may cause an operation failure or malfunction.
- Insert an FPC with the lever opened at right angle, that is, in the factory default position.
- After checking the position of FPC insertion slot and FPC, completely insert the FPC horizontally to the full depth of the connector without altering the angle.

An FPC inserted at an excessive angle to the board may cause the deformation of metal parts, crack of molding parts, FPC insertion failures, and FPC circuit breakages.

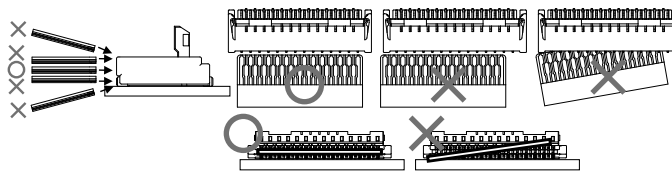

- Insert the FPC into the connector after checking the position of FPC insertion slot and FPC. Do not insert the FPC without positioning the FPC and connector. Otherwise, it may cause connector breakages. When it is hard to insert the FPC, do not insert the FPC on that condition. Confirm the FPC and connector positioning.
- Do not apply an excessive load to the lever in the opening direction beyond its open position; otherwise, the lever may be deformed or removed.
- Do not apply an excessive load to the lever in a direction perpendicular to the lever rotation axis or in the lever opening direction; otherwise, the terminals may be deformed, and the lever may be removed.



- To close the lever, turn down the lever by pressing the entire lever or both sides of the lever with fingers tips. And close the lever completely. Be careful not to apply partial load to the lever that may cause its deformation or destruction or lever going back to initial position.
- Close the lever completely to prevent contact failure.
- If pressure to the lever is applied unevenly, it may deform or break the FPC. Make sure that the lever is closed completely. Not doing so will cause a faulty connection.
- Avoid applying an excessive load to the top of the lever during or after closing the lever. Otherwise, the terminals may be deformed.
- When opening the lever to remove the FPC, rotate the lever to the initial position. Do not push the lever into the FPC inlet side and ensure that the lever will not go over the initial position; otherwise, it may be deformed or broken.
- To open the lever, if pressure to the lever is applied unevenly, such as to an edge only, it may deform or break.
- Do not open the lever forcefully with something sharp tool, otherwise, the lever may be deformed.
- Remove the FPC at parallel with the lever fully opened. If the lever is closed, or if the FPC is forcedly pulled, the product or FPC may break.
- If a lever is accidentally detached during the handling of a connector, do not use the connector any longer.

■ After an FPC is inserted, carefully handle it so as not to apply excessive stress to the base of the FPC. When using FPC with a bent condition, please pay attention to precautions below; otherwise, in some conditions it may cause conduction failure, connector breakage, unlocking lever or FPC disconnection.

- Design so that a load is not applied to connector directly by FPC bending.
- Avoid sharp FPC bending at the root of FPC insertion part.
- Design so that a load is not applied to the part of FPC bending.
- If there might be a load on FPC, please fix the FPC.
- Fix the FPC if there might be a load to the cut out, do not apply bending load to the cutout part of FPC. Otherwise, it may cause FPC disconnection and deformation since the cutout part of FPC is subjected to bending stress.



#### ■ Other cautions

- When coating the PC board after soldering the connector (to prevent the deterioration of insulation), perform the coating in such a way so that the coating does not get on the connector.
- The connectors are not meant to be used for switching.
- There is no problem on the product quality though the swelling and the black spot, etc. might be generated in the molding parts.
- The detailed shape of metal parts and molding parts may differ depending on the mold.
- Height in FPC mating depends on the way to being used, such as mounting condition, thickness of FPC, and angle of lever lock etc. Please check it by actual equipment.

Please refer to the latest product specifications when designing your product.

# Mouser Electronics

Authorized Distributor

Click to View Pricing, Inventory, Delivery & Lifecycle Information:

## Panasonic:

[AYF330765](#) [AYF330965](#) [AYF331165](#) [AYF331365](#) [AYF331565](#) [AYF331765](#) [AYF331965](#) [AYF332165](#) [AYF332365](#)  
[AYF332565](#) [AYF332765](#) [AYF332965](#) [AYF333165](#) [AYF333365](#) [AYF333565](#) [AYF333765](#) [AYF333965](#) [AYF334165](#)  
[AYF334365](#) [AYF334565](#) [AYF334765](#) [AYF334965](#) [AYF335165](#) [AYF335365](#) [AYF335565](#) [AYF335765](#) [AYF335965](#)  
[AYF336165](#) [AYF336365](#) [AYF336565](#) [AYF336765](#) [AYF336965](#) [AYF337165](#) [AYF337365](#) [AYF337565](#) [AYF337765](#)  
[AYF337965](#) [AYF338165](#) [AYF330735](#) [AYF331535](#) [AYF332135](#) [AYF332335](#) [AYF333335](#) [AYF332735](#) [AYF332535](#)  
[AYF333735](#)



Компания «ЭлектроПласт» предлагает заключение долгосрочных отношений при поставках импортных электронных компонентов на взаимовыгодных условиях!

Наши преимущества:

- Оперативные поставки широкого спектра электронных компонентов отечественного и импортного производства напрямую от производителей и с крупнейших мировых складов;
- Поставка более 17-ти миллионов наименований электронных компонентов;
- Поставка сложных, дефицитных, либо снятых с производства позиций;
- Оперативные сроки поставки под заказ (от 5 рабочих дней);
- Экспресс доставка в любую точку России;
- Техническая поддержка проекта, помощь в подборе аналогов, поставка прототипов;
- Система менеджмента качества сертифицирована по Международному стандарту ISO 9001;
- Лицензия ФСБ на осуществление работ с использованием сведений, составляющих государственную тайну;
- Поставка специализированных компонентов (Xilinx, Altera, Analog Devices, Intersil, Interpoint, Microsemi, Aeroflex, Peregrine, Syfer, Eurofarad, Texas Instrument, Miteq, Cobham, E2V, MA-COM, Hittite, Mini-Circuits, General Dynamics и др.);

Помимо этого, одним из направлений компании «ЭлектроПласт» является направление «Источники питания». Мы предлагаем Вам помощь Конструкторского отдела:

- Подбор оптимального решения, техническое обоснование при выборе компонента;
- Подбор аналогов;
- Консультации по применению компонента;
- Поставка образцов и прототипов;
- Техническая поддержка проекта;
- Защита от снятия компонента с производства.



#### Как с нами связаться

**Телефон:** 8 (812) 309 58 32 (многоканальный)

**Факс:** 8 (812) 320-02-42

**Электронная почта:** [org@eplast1.ru](mailto:org@eplast1.ru)

**Адрес:** 198099, г. Санкт-Петербург, ул. Калинина, дом 2, корпус 4, литера А.