



PRODUCT OVERVIEW

The D1U54-D-650-12-HBxC products are very high efficiency DC input 650 watt front end supplies provided with a 12V main and a 12V Standby output. An active (analogue) current share characteristic is provided to allow units to be operated in parallel. The power supply may be hot plugged; recovers from overtemperature faults, and has status LEDs on the front panel in addition to hardware signal logic and PMBus™ status signals. The low profile 1U package and 21.4W/cubic inch power density make them ideal for delivering reliable, efficient power to networking equipment, workstations, storage systems and other 12V distributed power architectures.

ORDERING GUIDE

Part Number	Murata Internal Part Number	Power Output -44 to -72Vdc	Main Output	Standby Output	Airflow
D1U54-D-650-12-HB3C	M1879	650W	12Vdc	12Vdc	Front to Back
D1U54-D-650-12-HB4C	M1878				Back to front

FEATURES

- 650W output power
- 93% efficiency at 50% load
- 12V main output
- 12V standby output
- 1U height:
- 2.15" x 9.00" x 1.57"
- 54.5mm x 228.6mm x 40mm
- 21.4 Watts per cubic inch density
- N+1 redundancy capable, including hot plugging
- Active (analogue) current sharing on 12V main output; ORing FET
- Overvoltage, Overcurrent, Overtemperature protection
- Internal cooling fan (variable speed)
- PMBus™/I2C interface with status indicators
- RoHS compliant
- Two Year Warranty



Available now at: www.murata-ps.com/en/3d/acdc.html

INPUT CHARACTERISTICS

Parameter	Conditions	Min.	Nom.	Max.	Units
Input Source Voltage Operating Range		-44	-53	-72	Vdc
Turn-on Input Voltage	Ramp up	-42.5	-43	-43.5	Vdc
Turn-off Input Voltage	Ramp down	-37.5	-38	-39.5	
Input current at Vin = -53Vdc	650W		13.6		Adc
Inrush Current	Cold start (25°C) between 0 to 200ms			25	Apk
Efficiency (-53Vdc) excluding fan load	20% load		90		%
	50% load		93		
	100% load		92		

OUTPUT VOLTAGE CHARACTERISTICS

Nominal Output Voltage	Parameter	Conditions	Min.	Typ.	Max.	Units
12V	Output Set Point Accuracy	50% load; Tamb = 25°C	11.96	12.00	12.04	Vdc
	Line and Load Regulation	Setpoint; temperature; line and load	-1.0%		+1.0%	%
	Ripple Voltage & Noise ^{1, 2}	20MHz Bandwidth			120	mV p-p
	Output Current Range		0		54.2	A
	Load Capacitance		500		4000	µF
12VSB	Output Set Point Accuracy	50% load; Tamb = 25°C	11.96	12.00	12.04	Vdc
	Line and Load Regulation	Setpoint; temperature; line and load	11.7		12.3	
	Ripple Voltage & Noise ¹	20MHz Bandwidth			120	mV p-p
	Output Current		0		2	A

¹ Ripple and noise is measured with a parallel combination 0.1µF of ceramic and 10µF of tantalum capacitance on each measurement node.

² Measurements assume the use of the minimum load capacitance as specified for the main 12V output and a minimum load of 5%. Below 5% loading the overall voltage deviation shall be within ±2.5%.



For full details go to www.murata-ps.com/rohs

Test Certificate and Test Report

OUTPUT CHARACTERISTICS					
Parameter	Conditions	Min.	Typ.	Max.	Units
Startup Time	DC ramp up			3	s
Transient Response	Main 12V, 50% load step, 1A/μs di/dt			±5	%
	12VSB, 50% load step, 1A/μs di/dt			500	μs
Current sharing accuracy	>10% load; *of maximum output current capability			±5*	%
Hot Swap Transients	All outputs remain in regulation			±	%
Holdup Time (Total Effective Hold Up - See Timing Waveforms)	Full DC Input Source Range; 100% load	2		4	ms

ENVIRONMENTAL CHARACTERISTICS					
Parameter	Conditions	Min.	Typ.	Max.	Units
Storage Temperature Range		-40		70	°C
Operating Temperature Range		-5		50	
Operating Humidity	Noncondensing; +45°C	5		90	%
Storage Humidity		5		95	
Altitude (without derating at 40°C)				3000	m
Shock	30G non-operating				
Operational Vibration	Sine sweep; 5-200Hz, 2G; random vibration, 5-500Hz, 1.11G				
MTBF(Target)	Per Telcordia SR-332 Issue 3 M1C3 @40°C		619K		hrs
Safety Approvals	CAN/CSA C22.2 No 60950-1-07, Am.1:2011 UL 60950-1-2011, 2nd Ed. IEC60950-1:2005 (2nd Ed.) w A1:2009 EN 60950-1:2006+A11+A1+A12+A2 CCC GB4943.1-2011; GB9254-1-2008; GB17625, 1-2012				
Input Fuse	Power Supply has an internal 25A/100Vdc fast blow fuse in the DC input negative line.				
Weight	1.74 lbs (0.789 kg)				

AIRFLOW; PRESSURE VS. FLOW (PQ) CURVES

D1U54-D-650-12-HB3C & D1U54-D-650-12-HB4C

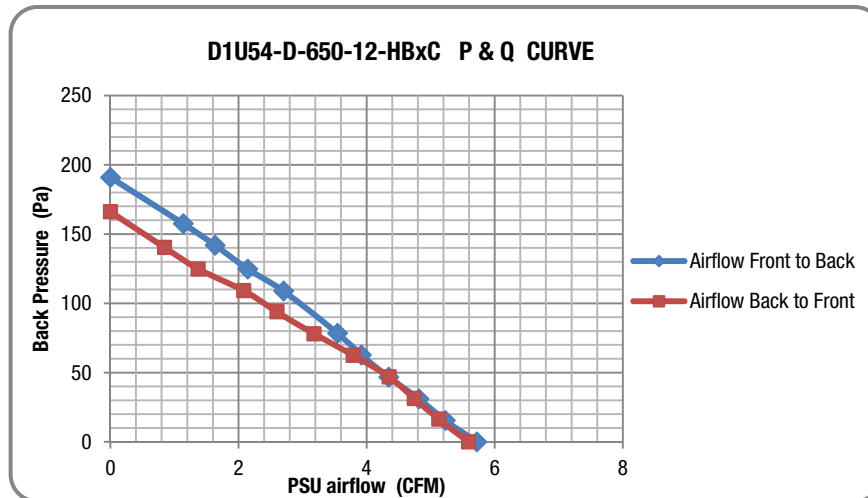

Notes:

1. The above curves represent performance based upon a the use of a 20mm thickness fan.
2. Curves recorded at room ambient (circa 25°C).
3. Curves generated with internal fan running at 100% duty cycle

PROTECTION CHARACTERISTICS

Output	Parameter	Conditions	Min.	Typ.	Max.	Units
	Overtemperature	Autorestart with 4°C hysteresis for recovery (warning issued at 70°C)		75		°C
12V	Overvoltage	Latching	13		14.5	°C
	Overcurrent (Target)	The output shall shutdown when an overcurrent condition is detected. It will auto restart after 1sec; however if the overcurrent condition is redetected the output will once again shutdown. The output will once again re-start, however if the overcurrent condition persists it will latch of after the fifth unsuccessful attempt. To reset the latch it will be necessary to toggle the PS_ON_L signal (B4) or recycle the incoming DC source.	60		70	A
12VSB	Overvoltage	Latching	13.0		14.5	V
	Overcurrent	The output shall shutdown when an overcurrent is detected. It will auto restart after 2sec; however if the overcurrent is re-detected the output will once again shutdown. This cycle will occur indefinitely while the overcurrent condition persists.	2.2		2.8	A

ISOLATION CHARACTERISTICS

Parameter	Conditions	Min.	Typ.	Max.	Units
Insulation Safety Rating	Input to Output	1000			Vdc
	Input to Chassis	1000			Vdc
Isolation	Output to Chassis	500			Vdc

EMISSIONS AND IMMUNITY

Conducted Emissions	FCC 47 CFR Part 15/CISPR 22/EN55022	Class A with 6dB margin
ESD Immunity	IEC/EN 61000-4-2	Level 4 criteria A
Radiated Field Immunity	IEC/EN 61000-4-3	Level 3 criteria B
Electrical Fast Transients/Burst Immunity	IEC/EN 61000-4-4	Level 3 criteria B
Surge Immunity	IEC/EN 61000-4-5	±1kV common mode and differential mode, unit passes criteria A (normal performance)*
RF Conducted Immunity	IEC/EN 61000-4-6	Level 3 criteria A
Magnetic Field Immunity	IEC/EN 61000-4-8	3 A/m criteria B
Voltage Dips, Interruptions	----	-53V _{in} , 80% load, Dip 100% Duration 4ms, Criteria (A)

* Impedance is 2 ohms for differential and common mode.

STATUS INDICATORS

LED NAME	LED MODE	LED STATE/OPERATION	DESCRIPTION
Input	OK	Solid Green	Input voltage operating within normal specified range
Input	OV/UV WARNING	Blinking Green	Input voltage operating in: 1) overvoltage warning, or 2) undervoltage warning range
Input	OFF OR FAULT	Off	Input voltage operating: 1) above overvoltage range, or 2) below undervoltage range, or 3) not present
Output	POWER GOOD	Solid Green	Main output and standby output enabled with no power supply warning or fault detected
Output	STANDBY	Blinking Green	Standby output enabled with no power supply warning or fault detected
Output	WARNING	Blinking Amber	Power supply warning detected as per PMBus STATUS_X reporting bytes*
Output	FAULT	Solid Amber	Power supply fault detected as per PMBus STATUS_X reporting bytes*

*LED fault/warning operation follows PMBus fault/warning reporting status flags and will thus also be 'sticky' (i.e. even if actual fault/warning is cleared, LED will still be in FAULT or WARNING mode until PMBus status flags are cleared with the CLEAR_FAULTS command)

STATUS AND CONTROL SIGNALS			
Signal Name	I/O	Description	Interface Details
INPUT_OK (DC Source)	Output	The signal output is driven high when the input source is available and within acceptable limits. The output is driven low to indicate loss of input power. There is a minimum of 5ms pre-warning time before signal changes to a high impedance state or is driven low to indicate loss of 12V. The power supply must ensure that this interface signal provides accurate status when DC power is lost.	Pulled up internally via 10K to 3.3Vdc. A logic high >2.0Vdc; A logic low <0.8Vdc Driven low by internal CMOS buffer (open drain output).
PW_OK (Output OK)	Output	The signal is asserted, driven high, by the power supply to indicate that all outputs are valid. If any of the outputs fail then this output will be hi-Z or driven low. The output is driven low to indicate that the Main output is outside of lower limit of regulation.	Pulled up internally via 10K to 3.3Vdc. A logic high >2.0Vdc; A logic low <0.8Vdc Driven low by internal CMOS buffer (open drain output).
SMB_ALERT (FAULT/WARNING)	Output	The signal output is driven low to indicate that the power supply has detected a warning or fault and is intended to alert the system. This output must be driven high when the power is operating correctly (within specified limits). The signal will revert to a high level when the warning/fault stimulus (that caused the alert) is removed.	Pulled up internally via 10K to 3.3Vdc. A logic high >2.0Vdc; A logic low <0.8Vdc Driven low by internal CMOS buffer (open drain output).
PRESENT_L (Power Supply Absent)	Output	The signal is used to detect the presence (installed) of a PSU by the host system. The signal is connected to PSU logic SGND within the power module.	Passive connection to +VSB_Return. A logic low <0.8Vdc
PS_ON (Power Supply Enable/Disable)	Input	This signal is pulled up internally to the internal housekeeping supply (within the power supply). The power supply main 12Vdc output will be enabled when this signal is pulled low to +VSB_Return. In the low state the signal input shall not source more than 1mA of current. The 12Vdc output will be disabled when the input is driven higher than 2.4V, or open circuited. Cycling this signal shall clear latched fault conditions.	Pulled up internally via 10K to 3.3Vdc. A logic high >2.0Vdc A logic low <0.8Vdc Input is via CMOS Schmitt trigger buffer.
PS_KILL	Input	This signal is used during hot swap to disable the main output during hot swap extraction. The input is pulled up internally to the internal housekeeping supply (within the power supply). The signal is provided on a short (lagging pin) and should be connected to +VSB_Return.	Pulled up internally via 10K to 3.3Vdc. A logic high >2.0Vdc; A logic low <0.8Vdc Input is via CMOS Schmitt trigger buffer.
ADDR (Address Select)	Input	An analogue input that is used to set the address of the internal slave devices (EEPROM and microprocessor) used for digital communications. Connection of a suitable resistor to +VSB_Return, in conjunction with an internal resistor divider chain, will configure the required address (see ADDR Address Selection table).	DC voltage between the limits of 0 and +3.3Vdc.
SCL (Serial Clock)	Both	A serial clock line compatible with PMBus™ Power Systems Management Protocol Part 1 – General Requirements Rev 1.1. No additional internal capacitance is added that would affect the speed of the bus. The signal is provided with a series isolator device to disconnect the internal power supply bus in the event that the power module is completely unpowered,	V _L is 0.8V maximum V _{OL} is 0.4V maximum when sinking 3mA V _H is 2.1V minimum
SDA (Serial Data)	Both	A serial data line compatible with PMBus™ Power Systems Management Protocol Part 1 – General Requirements Rev 1.1. The signal is provided with a series isolator device to disconnect the internal power supply bus in the event that the power module is completely unpowered,	V _L is 0.8V maximum V _{OL} is 0.4V maximum when sinking 3mA V _H is 2.1V minimum
V1_SENSE V1SENSE_RTN	Input	Remote sense connections intended to be connected at and sense the voltage at the point of load. The voltage sense will interact with the internal module regulation loop to compensate for voltage drops due to connection resistance between the output connector and the load. If remote sense compensation is not required then the voltage shall be configured for local sense by: 1. V1_SENSE directly connected to power blades 6 to 10 (inclusive) 2. V1_SENSE_RTN directly connected to power blades 1 to 5 (inclusive)	Compensation for up to 0.12Vdc total connection drop (output and return connections).
ISHARE	Bi-Directional Analogue Bus	The current sharing signal is connected between sharing units (forming an ISHARE bus). It is an input and/or an output (bi-directional analogue bus) as the voltage on the line controls the current share between sharing units. A power supply will respond to a change in this voltage but a power supply can also change the voltage depending on the load drawn from it. On a single unit the voltage on the pin (and the common ISHARE bus would read 8VDC at 100% load (module capability). For two identical units sharing the same 100% load this would read 4VDC for perfect current sharing (i.e. 50% module load capability per unit).	Analogue voltage: +8V maximum; 10K to +12V_RTN

TIMING SPECIFICATIONS

Turn-On Delay & Output Rise Time:

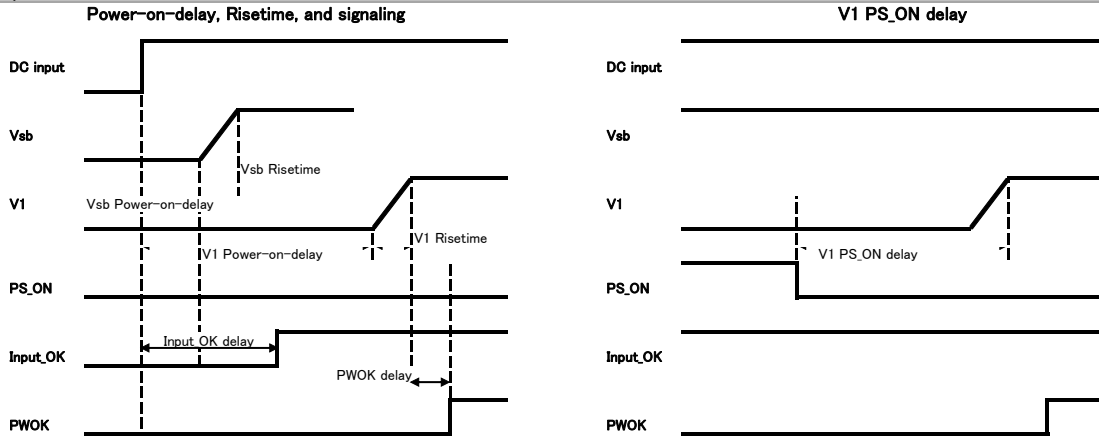

1. The turn-on delay after application of AC input within the operating range shall as defined in the following tables.
2. The output rise times shall be measured from 10% of the nominal output to the lower limit of the regulation band as defined in the following tables.

Time	Min	Max
Vsb Rise time	70ms	170ms
V1 Rise time	120ms	220ms
Vsb Power-on-delay	300ms	700ms
V1 Power-on-delay	500ms	1500ms
V1 PS_ON delay	100ms	300ms
V1 PWOK delay	300ms	450ms
DCOK (Input) detect	500ms	1000ms

TIMING SPECIFICATIONS

Turn-Off (Shutdown by PS_ON)

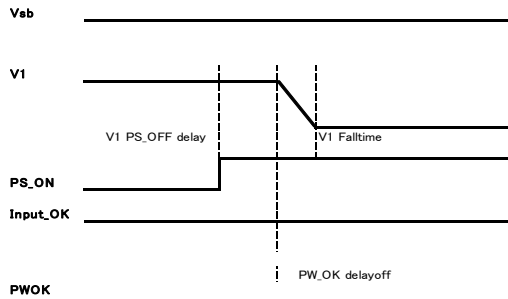

Turn-Off Timing	Min	Max	Notes
V1 Fall time	-	-	Must be monotonic
V1 PS_OFF delay	0ms	6ms	
PW_OK delay off	2.0ms		

1. Note this characteristic is applicable for the main 12Vdc output shutdown from PS_ON pulled high.

TIMING SPECIFICATIONS

Power Removal Holdup

Power Removal Timing	Min	Max	Notes
Vsb holdup	20ms	50ms	+VSB Full Load
V1 holdup (Total Effective)	4ms	-	100% load
DC (Input) fail detect	400µs	1000µs	
PWOK delay off	2.0ms		
PWOK Hold Up	2.0ms	4.0ms	100% load

OUTPUT CONNECTOR & SIGNAL INTERFACE: FCI PN 10122460-005LF

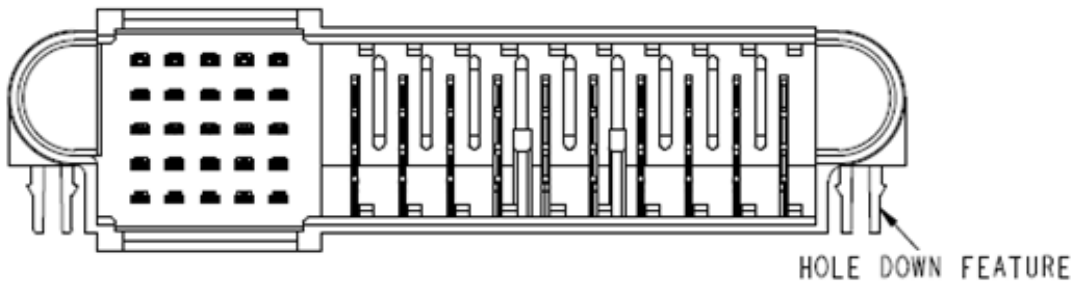

PART NUMBER	ROWS	SIGNALS					POWERS											
		1	2	3	4	5	1	2	3	4	5	6	7	8	9	10		
10122460-005LF 25S + 10P	E	H	2	2	2	3	2	2	2	2	2	2	2	2	2	2	2	H
	D																	
	C																	
	A																	

NB: Reference to "3" in Column 5, refers to the shortest level signal pin; the "shortest" pins are the "last to make, first to break" in the mating sequence.

OUTPUT CONNECTOR PIN ASSIGNMENTS - D1U54P-W-650-12-HBxC

(Power Supply) FCI PN 10122460-005LF

Pin	Signal Name	Comments
6, 7, 8, 9, 10	V1 (+12VOUT)	+12V Main Output
1, 2, 3, 4, 5	+12V RTN/PGND	+12V Main Output Return
A1	+VSB	Standby Output
B1	+VSB	Standby Output
C1	+VSB	Standby Output
D1	+VSB	Standby Output
E1	+VSB	Standby Output
A2	+VSB_Return	Standby Output Return
B2	+VSB_Return	Standby Output Return
C2	Unused	No End User Connection
D2	Unused	No End User Connection
E2	Unused	No End User Connection
A3	APS	I ² C Address Protocol Selection; (Select address by appropriate pull down resistor – See table below)
B3	Unused	No End User Connection
C3	SDA	I ² C Serial Data Line
D3	V1_SENSE_R	-VE Remote Sense Return
E3	V1_SENSE	+VE Remote Sense
A4	SCL	I ² C Serial Clock Line
B4	PS_ON_L	Remote On/Off (Enable/Disable)
C4	SMB_ALERT	Alert signal to host system
D4	Unused	No End User Connection
E4	INPUT_OK	DC Input Source Present & "OK"
A5	PS_KILL	Power Supply "kill"; short pin
B5	ISHARE	Active Current Share Bus
C5	PW_OK	Power "OK"; short pin
D5	Unused	No End User Connection
E5	PRESENT_L	Power Module Present; short pin

MATING CONNECTOR

Part Number	Description
TE Connectivity 2-1926739-5	Right Angle
FCI 10108888-R10253SLF	Right Angle

APS ADDRESS SELECTION

APS pin (A3) resistor to GND (K-ohm)*	Power Supply Main Controller (Serial Communications Slave Address)	Power Supply External EEPROM (Serial Communications Slave Address)
0.82	0xB0	0xA0
2.7	0xB2	0xA2
5.6	0xB4	0xA4
8.2	0xB6	0xA6
15	0xB8	0xA8
27	0xBA	0xAA
56	0xBC	0xAC
180	0xBE	0xAE

* The resistor shall be +/-5% tolerance

WIRING DIAGRAM FOR OUTPUT

 Dotted lines show optional remote sense connections.
 Optional remote sense lines can be attached to a load that is a distance away from the power supply to improve regulation at the load.

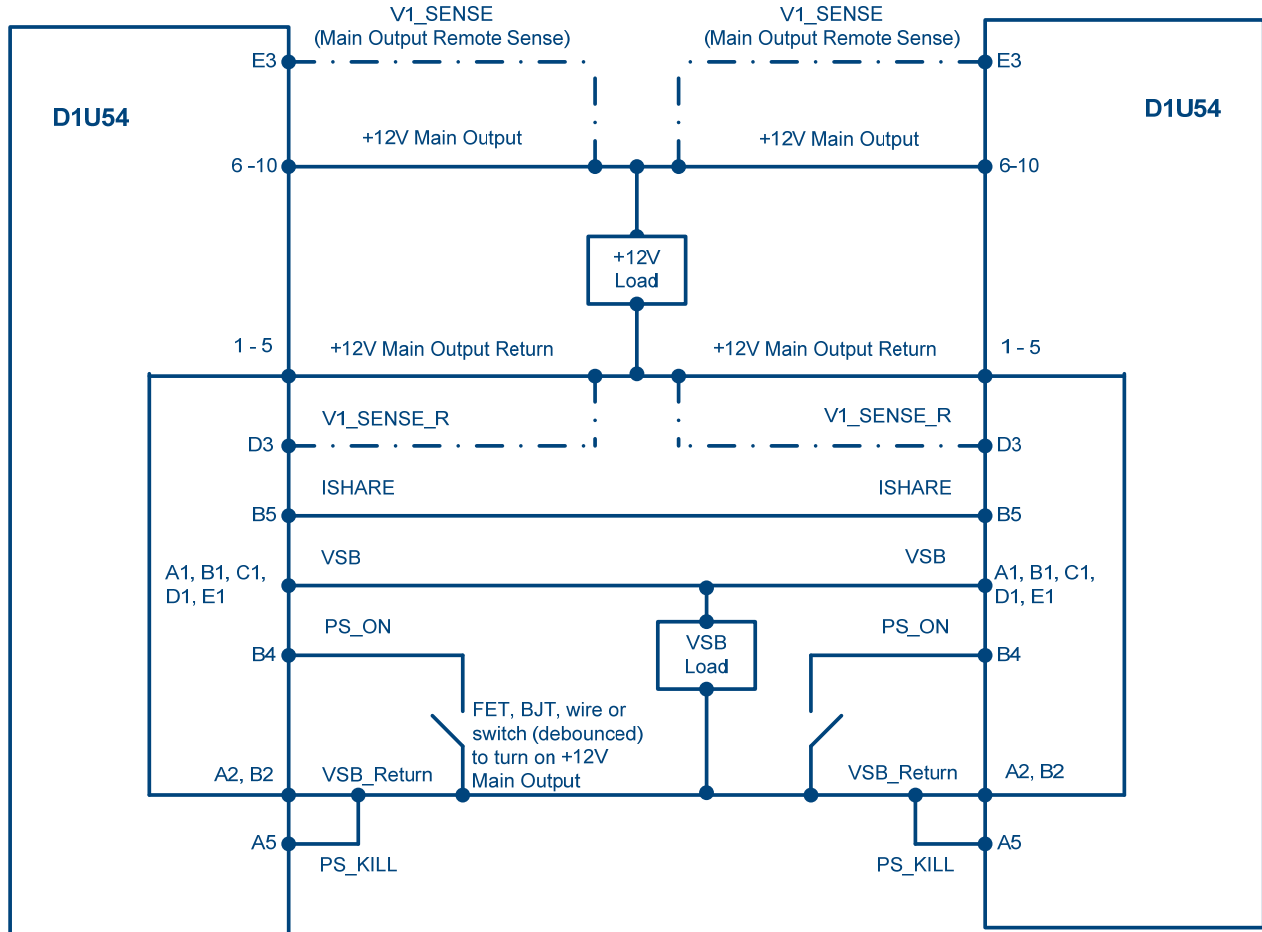

CURRENT SHARE NOTES

1. Main Output: Current sharing is achieved using the active (analogue) current share method.
2. Current sharing can be achieved with or without the remote (V_SENSE and V_SENSE_R) connected to the common load.
3. +VSB Outputs can be tied together for redundancy but total combined output power must not exceed the rated standby power. The +VSB output has an internal ORing MOSFET for additional redundancy/internal short protection.
4. The current sharing pin B5 is connected between sharing units (forming an ISHARE bus). It is an input and/or an output (bi-directional analogue bus) as the voltage on the line controls the current share between sharing units. A power supply will respond to a change in this voltage but a power supply can also change the voltage depending on the load drawn from it. On a single unit the voltage on the pin (and the common ISHARE bus) would read 8VDC at 100% (power module load capability). For two units sharing the same 100% load this would read 4VDC for perfect current sharing (i.e. 50% power module load capability per unit). The load for both the main 12V and the VSB rails at initial startup shall not be allowed to exceed the capability of a single unit. The load can be increased after a delay of 3sec (minimum), to allow all sharing units to achieve steady state regulation.

MECHANICAL DIMENSIONS

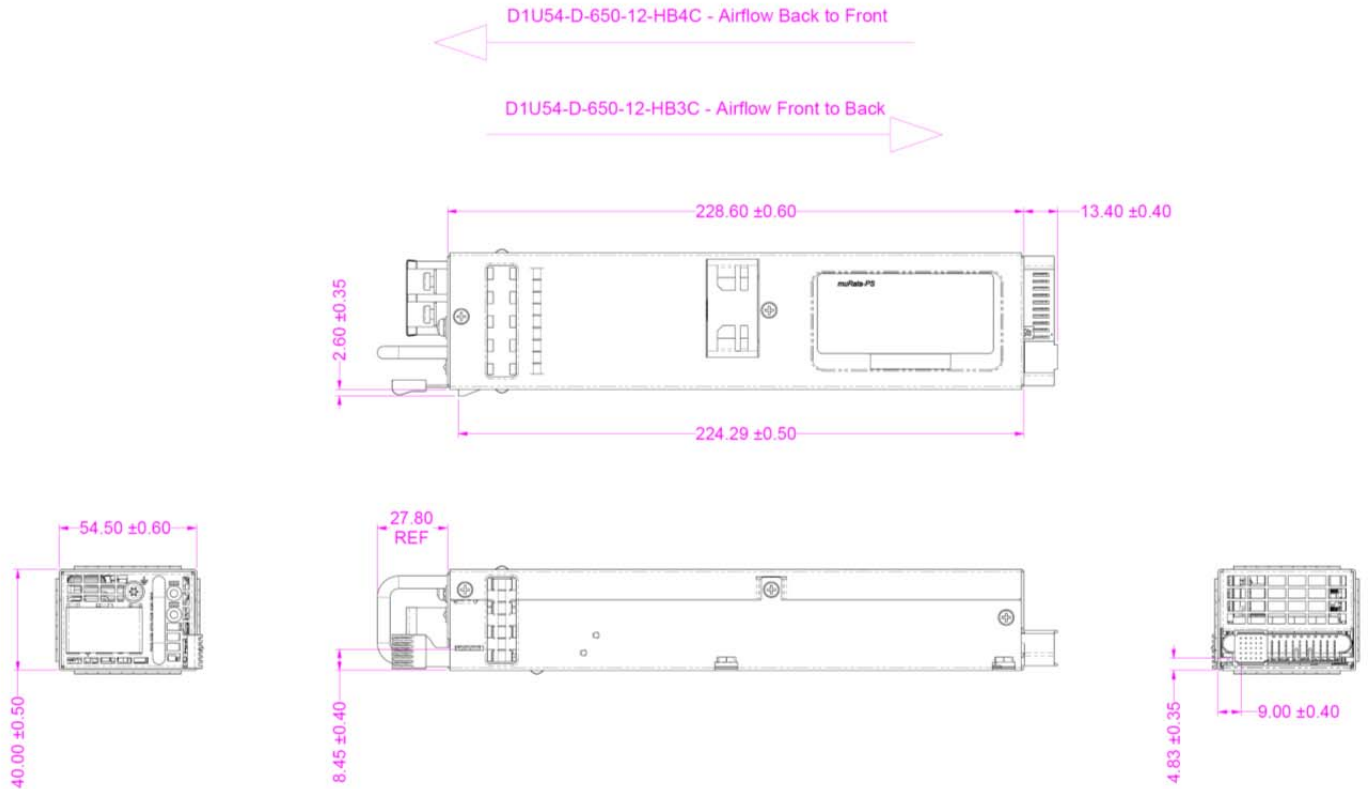

1. DC input connector: Dinkle Terminal Block, Dinkle Enterprise: Part No. DT-7C-B14W-02
2. Dimensions: 2.15" x 9.00" x 1.57" [54.5mm x 228.6mm x 40.0mm]
3. This drawing is a graphical representation of the product and may not show all fine details.
4. Reference File: D1U54-D-650-12-HBxC (M1878-M1879)_Drawing for Product Datasheet_20151216.pdf

OPTIONAL ACCESSORIES

Description	Part Number
12V D1U54P Output Connector Card	D1U54P-12-CONC

APPLICATION NOTES

Document Number	Description	Link
ACAN-64	D1U54P Output Connector Card	http://power.murata.com/datasheet/?data/apnotes/acan-64.pdf
ACAN-60	D1U54-x Communication Protocol	http://power.murata.com/datasheet/?data/apnotes/acan-60.pdf



This product is subject to the following operating requirements and the Life and Safety Critical Application Sales Policy:

Refer to: <http://www.murata-ps.com/requirements/>

Murata Power Solutions, Inc. makes no representation that the use of its products in the circuits described herein, or the use of other technical information contained herein, will not infringe upon existing or future patent rights. The descriptions contained herein do not imply the granting of licenses to make, use, or sell equipment constructed in accordance therewith. Specifications are subject to change without notice. © 2016 Murata Power Solutions, Inc.

Murata Power Solutions, Inc.
 11 Cabot Boulevard, Mansfield, MA 02048 -1151 U.S.A.
 ISO 9001 and 14001 REGISTERED



Компания «ЭлектроПласт» предлагает заключение долгосрочных отношений при поставках импортных электронных компонентов на взаимовыгодных условиях!

Наши преимущества:

- Оперативные поставки широкого спектра электронных компонентов отечественного и импортного производства напрямую от производителей и с крупнейших мировых складов;
- Поставка более 17-ти миллионов наименований электронных компонентов;
- Поставка сложных, дефицитных, либо снятых с производства позиций;
- Оперативные сроки поставки под заказ (от 5 рабочих дней);
- Экспресс доставка в любую точку России;
- Техническая поддержка проекта, помощь в подборе аналогов, поставка прототипов;
- Система менеджмента качества сертифицирована по Международному стандарту ISO 9001;
- Лицензия ФСБ на осуществление работ с использованием сведений, составляющих государственную тайну;
- Поставка специализированных компонентов (Xilinx, Altera, Analog Devices, Intersil, Interpoint, Microsemi, Aeroflex, Peregrine, Syfer, Eurofarad, Texas Instrument, Miteq, Cobham, E2V, MA-COM, Hittite, Mini-Circuits, General Dynamics и др.);

Помимо этого, одним из направлений компании «ЭлектроПласт» является направление «Источники питания». Мы предлагаем Вам помощь Конструкторского отдела:

- Подбор оптимального решения, техническое обоснование при выборе компонента;
- Подбор аналогов;
- Консультации по применению компонента;
- Поставка образцов и прототипов;
- Техническая поддержка проекта;
- Защита от снятия компонента с производства.



Как с нами связаться

Телефон: 8 (812) 309 58 32 (многоканальный)

Факс: 8 (812) 320-02-42

Электронная почта: org@eplast1.ru

Адрес: 198099, г. Санкт-Петербург, ул. Калинина, дом 2, корпус 4, литера А.