

Analog Devices Welcomes Hittite Microwave Corporation

NO CONTENT ON THE ATTACHED DOCUMENT HAS CHANGED



THIS PAGE INTENTIONALLY LEFT BLANK



GaAs InGaP HBT MMIC BROADBAND AMPLIFIER GAIN BLOCK, DC - 6 GHz

Typical Applications

Ideal as a Driver & Amplifier for:

- 2.2 - 2.7 GHz MMDS
- 3.5 GHz Wireless Local Loop
- 5 - 6 GHz UNII & HiperLAN

Features

- P1dB Output Power: +14 dBm
- Output IP3: +27 dBm
- Gain: 17 dB
- Single Supply: +5V
- High Reliability GaAs HBT Process
- Ultra Small Package: SOT26
- Included in the HMC-DK001 Designer's Kit

Functional Diagram

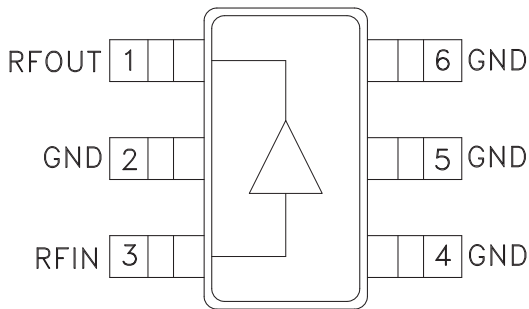

General Description

The HMC313 & HMC313E are GaAs InGaP Heterojunction Bipolar Transistor (HBT) MMIC amplifiers that operate from a single Vcc supply. The surface mount SOT26 amplifier can be used as a broadband gain stage or used with external matching for optimized narrow band applications. With Vcc biased at +5V, the HMC313(E) offers 17 dB of gain and +15 dBm of saturated power while only requiring 50 mA of current.

Electrical Specifications, $T_A = +25^\circ\text{C}$, $V_{CC} = +5.0\text{V}$

Parameter	Vcc = +5V			Units
	Min.	Typ.	Max.	
Frequency Range	DC - 6			GHz
Gain	14	17	20	dB
Gain Variation Over Temperature		0.02	0.03	dB/°C
Input Return Loss		7		dB
Output Return Loss		6		dB
Reverse Isolation		30		dB
Output Power for 1 dB Compression (P1dB) @ 1.0 GHz	11	14		dBm
Saturated Output Power (Psat) @ 1.0 GHz		15		dBm
Output Third Order Intercept (IP3) @ 1.0 GHz	24	27		dBm
Noise Figure		6.5		dB
Supply Current (Icc)		50		mA

Note: Data taken with broadband bias tee on device output.

For price, delivery, and to place orders, please contact Hittite Microwave Corporation:
 20 Alpha Road, Chelmsford, MA 01824 Phone: 978-250-3343 Fax: 978-250-3373
 Order On-line at www.hittite.com

GaAs InGaP HBT MMIC BROADBAND AMPLIFIER GAIN BLOCK, DC - 6 GHz

Gain & Return Loss

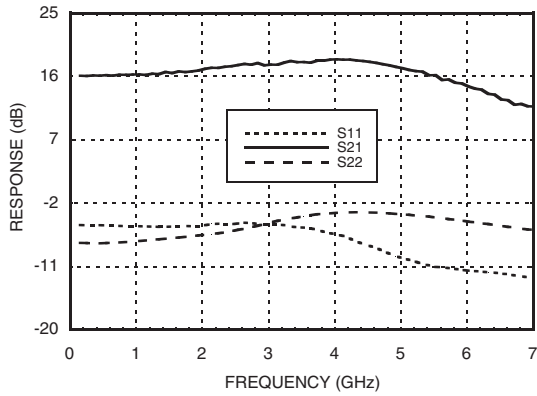

Gain vs. Temperature

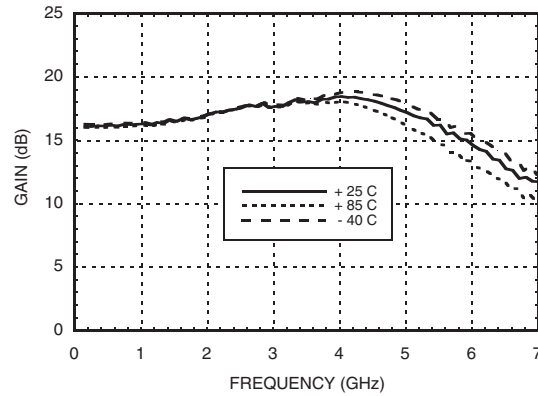

Input & Output Return Loss

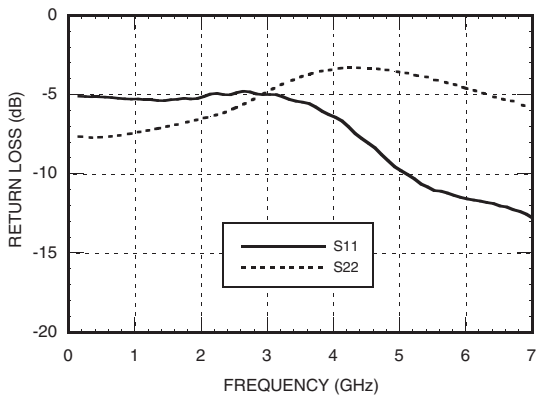

Reverse Isolation

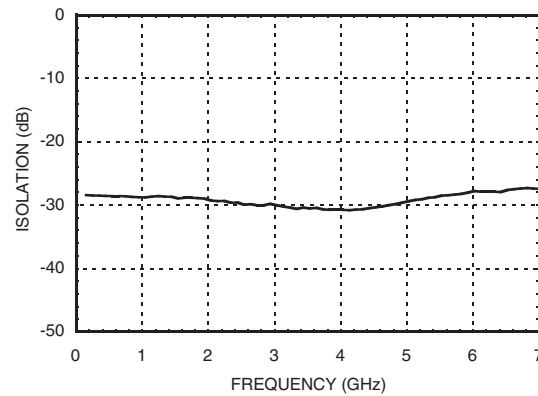

P1dB vs. Temperature

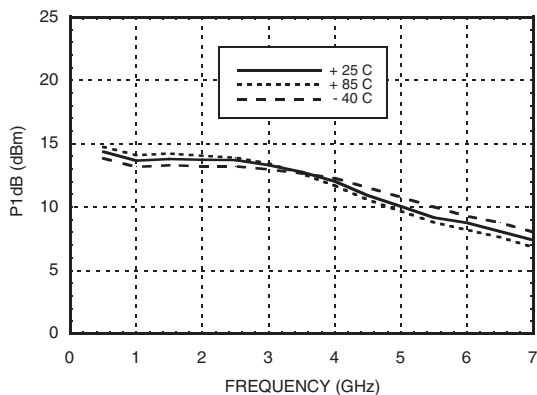

Psat vs. Temperature

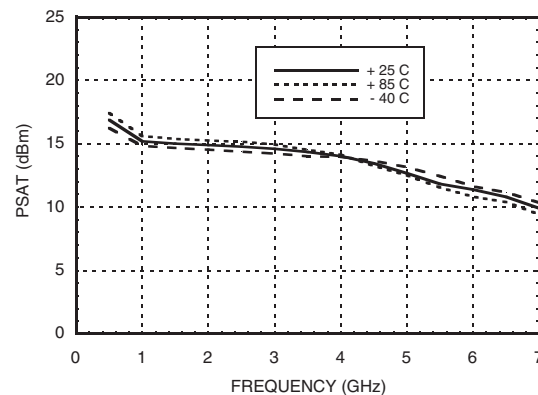



GaAs InGaP HBT MMIC BROADBAND AMPLIFIER GAIN BLOCK, DC - 6 GHz

Output IP3 vs. Temperature

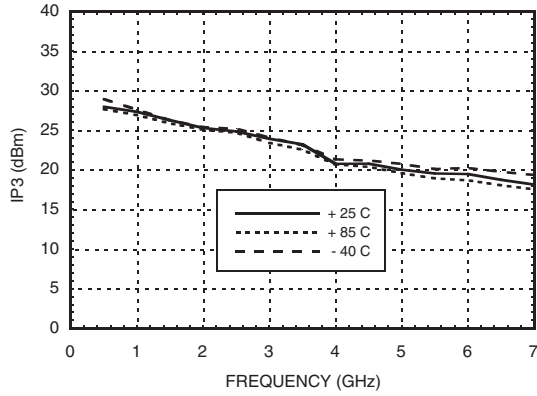

Power Compression @ 1 GHz

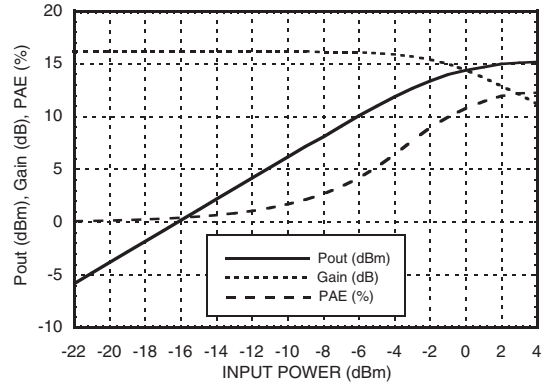

Power Compression @ 3 GHz

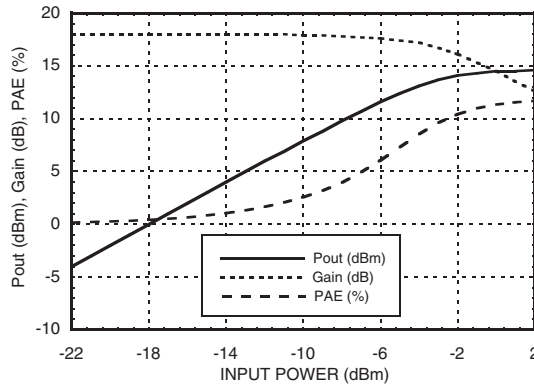

GaAs InGaP HBT MMIC BROADBAND AMPLIFIER GAIN BLOCK, DC - 6 GHz

Absolute Maximum Ratings

Collector Bias Voltage (Vcc)	+5.5 Vdc
RF Input Power (RFIN)(Vcc = +5Vdc)	+20 dBm
Junction Temperature	150 °C
Continuous P _{diss} (T = 85 °C) (derate 3.99 mW/°C above 85 °C)	0.259 W
Thermal Resistance (junction to lead)	251 °C/W
Storage Temperature	-65 to +150 °C
Operating Temperature	-40 to +85 °C
ESD Sensitivity (HBM)	Class 1A



ELECTROSTATIC SENSITIVE DEVICE
OBSERVE HANDLING PRECAUTIONS

Outline Drawing

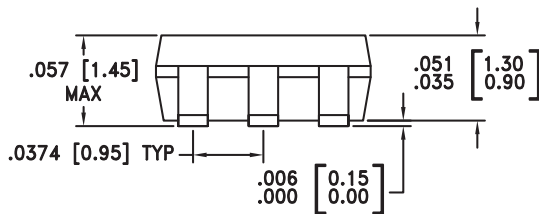
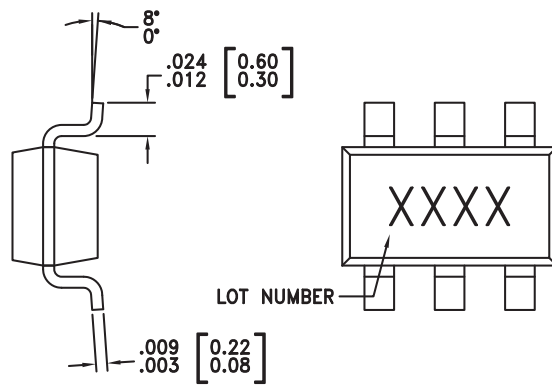
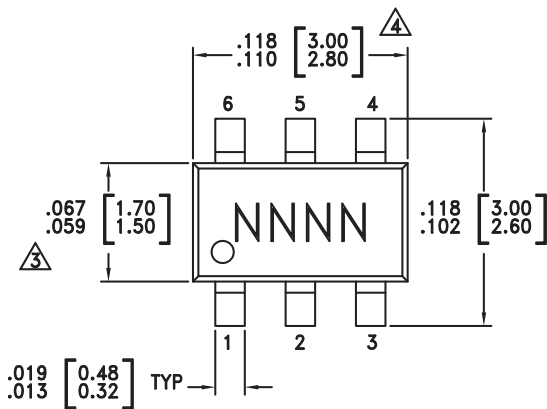

NOTES:

1. LEADFRAME MATERIAL: COPPER ALLOY
2. DIMENSIONS ARE IN INCHES [MILLIMETERS]
- △ DIMENSION DOES NOT INCLUDE MOLDFLASH OF 0.15mm PER SIDE.
- △ DIMENSION DOES NOT INCLUDE MOLDFLASH OF 0.25mm PER SIDE.
5. ALL GROUND LEADS MUST BE SOLDERED TO PCB RF GROUND

Package Information

Part Number	Package Body Material	Lead Finish	MSL Rating	Package Marking ^[3]
HMC313	Low Stress Injection Molded Plastic	Sn/Pb Solder	MSL1 ^[1]	H313 XXXX
HMC313E	RoHS-compliant Low Stress Injection Molded Plastic	100% matte Sn	MSL1 ^[2]	313E XXXX



[1] Max peak reflow temperature of 235 °C

[2] Max peak reflow temperature of 260 °C

[3] 4-Digit lot number XXXX

For price, delivery, and to place orders, please contact Hittite Microwave Corporation:
20 Alpha Road, Chelmsford, MA 01824 Phone: 978-250-3343 Fax: 978-250-3373
Order On-line at www.hittite.com

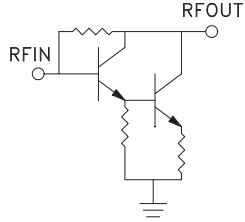
Pin Descriptions

Pin Number	Function	Description	Interface Schematic
1	RFOUT	This pin is DC coupled. An off chip DC blocking capacitor is required.	
3	RFIN	This pin is DC coupled. An off chip DC blocking capacitor is required.	
2, 4-6	GND	These pins must be connected to RF/DC ground.	

Application Circuit

Recommended Bias Resistor Values for $I_{cc} = 50 \text{ mA}$, $R_{bias} = (V_s - 5.0) / I_{cc}$

Supply Voltage (Vs)	5V	6V	8V
RBIAS VALUE	0 Ω	20 Ω	62 Ω
RBIAS POWER RATING		¼ W	½ W

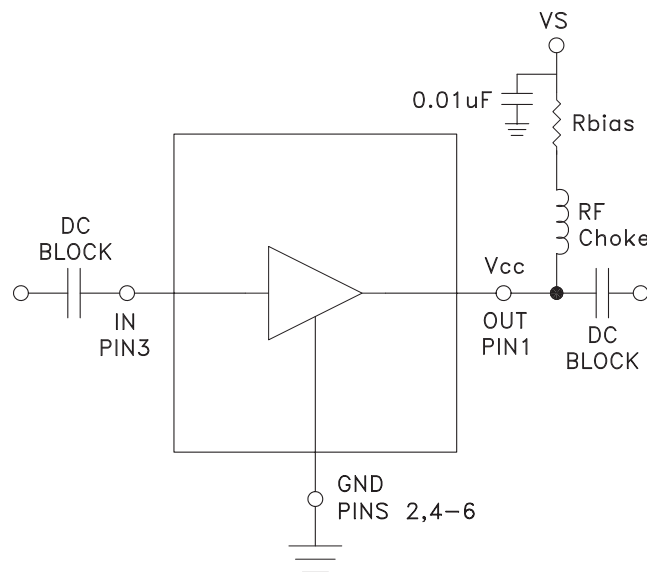

Note:

1. Select R_{bias} to achieve desired V_{cc} voltage on Pin 1.
2. External Blocking Capacitors are required on Pins 1 & 3.

Evaluation PCB

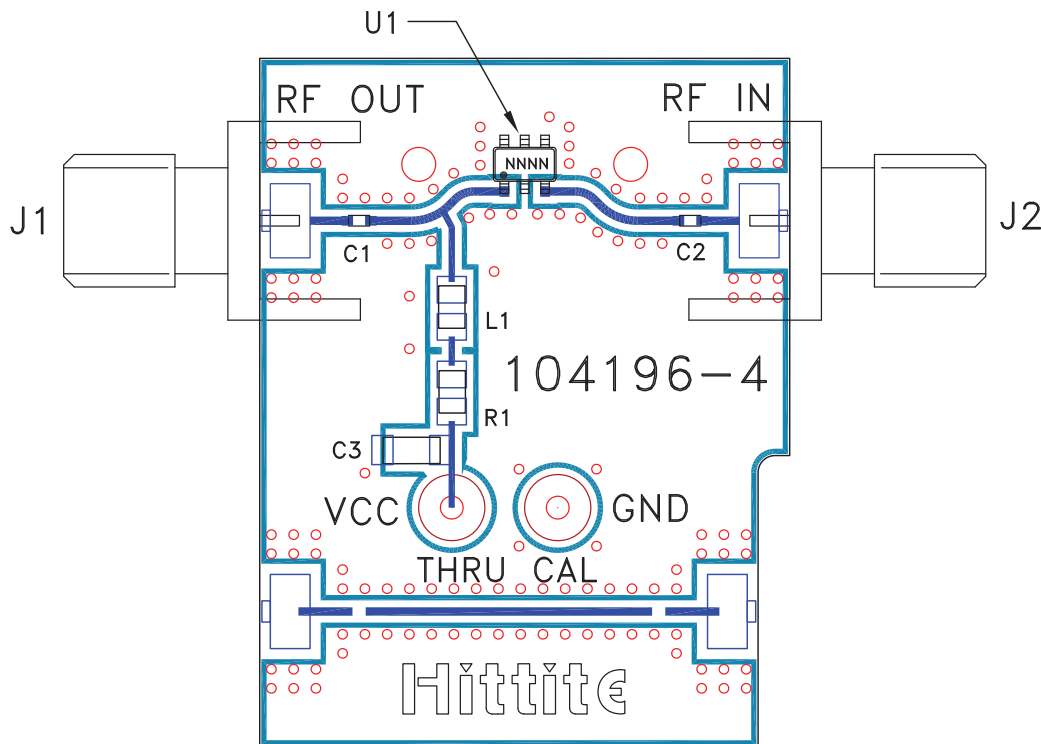

List of Materials for Evaluation PCB 104217 [1]

Item	Description
J1 - J2	PCB Mount SMA Connector
C1 - C2	100 pF Capacitor, 0402 Pkg.
C3	100 pF Capacitor, 0805 Pkg.
L1	22 nH Inductor, 0805 Pkg.
R1	22 Ω Resistor, 0805 Pkg.
U1	HMC313 / HMC313E
PCB [2]	104196 Evaluation PCB

[1] Reference this number when ordering complete evaluation PCB

[2] Circuit Board Material: Arlon 25FR or Roger 4350

The circuit board used in the final application should use RF circuit design techniques. Signal lines should have 50 ohm impedance while the package ground leads should be connected directly to the ground plane similar to that shown. A sufficient number of via holes should be used to connect the top and bottom ground planes. The evaluation circuit board shown is available from Hittite upon request.



Компания «ЭлектроПласт» предлагает заключение долгосрочных отношений при поставках импортных электронных компонентов на взаимовыгодных условиях!

Наши преимущества:

- Оперативные поставки широкого спектра электронных компонентов отечественного и импортного производства напрямую от производителей и с крупнейших мировых складов;
- Поставка более 17-ти миллионов наименований электронных компонентов;
- Поставка сложных, дефицитных, либо снятых с производства позиций;
- Оперативные сроки поставки под заказ (от 5 рабочих дней);
- Экспресс доставка в любую точку России;
- Техническая поддержка проекта, помощь в подборе аналогов, поставка прототипов;
- Система менеджмента качества сертифицирована по Международному стандарту ISO 9001;
- Лицензия ФСБ на осуществление работ с использованием сведений, составляющих государственную тайну;
- Поставка специализированных компонентов (Xilinx, Altera, Analog Devices, Intersil, Interpoint, Microsemi, Aeroflex, Peregrine, Syfer, Eurofarad, Texas Instrument, Miteq, Cobham, E2V, MA-COM, Hittite, Mini-Circuits, General Dynamics и др.);

Помимо этого, одним из направлений компании «ЭлектроПласт» является направление «Источники питания». Мы предлагаем Вам помощь Конструкторского отдела:

- Подбор оптимального решения, техническое обоснование при выборе компонента;
- Подбор аналогов;
- Консультации по применению компонента;
- Поставка образцов и прототипов;
- Техническая поддержка проекта;
- Защита от снятия компонента с производства.



Как с нами связаться

Телефон: 8 (812) 309 58 32 (многоканальный)

Факс: 8 (812) 320-02-42

Электронная почта: org@eplast1.ru

Адрес: 198099, г. Санкт-Петербург, ул. Калинина, дом 2, корпус 4, литера А.