

AFBR-S4N44C013

4×4 NUV-HD Silicon Photo Multiplier Array

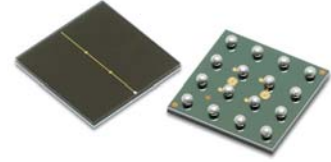

Description

The Broadcom® AFBR-S4N44C013 is a silicon photo multiplier (SiPM) array used for ultra-sensitive precision measurement of single photons. The active area is $3.72 \times 3.72 \text{ mm}^2$. High packing density of the single chip is achieved using through-silicon-via (TSV) technology. Larger areas can be covered by tiling multiple AFBR-S4N44C013 arrays almost without any edge losses. The passivation layer is made by a glass highly transparent down to UV wavelengths, resulting in a broad response in the visible light spectrum with high sensitivity towards blue- and near-UV region of the light spectrum. The SiPM is best suited for the detection of low-level pulsed light sources, especially for detection of Cherenkov- or scintillation light from the most common organic (plastic) and inorganic scintillator materials (for example, LSO, LYSO, BGO, NaI, CsI, BaF, LaBr). This product is lead free and compliant with RoHS and REACH.

Block Diagram

Figure 1: AFBR-S4N44C013 Block Diagram

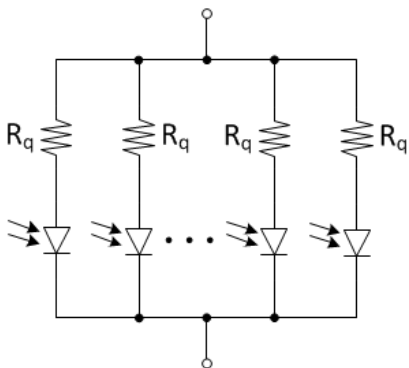

Features

- High PDE of more than 55% at 420 nm
- High fill factors
- Excellent SPTR and CRT
- Excellent uniformity of breakdown voltage, 180 mV (3 sigma)
- Excellent uniformity of gain
- With TSV technology (4-side tilable)
- Size $3.88 \times 3.88 \text{ mm}^2$
- Cell pitch $30 \times 30 \text{ }\mu\text{m}^2$
- Highly transparent glass protection layer
- Operating temperature range from -20°C to $+50^\circ\text{C}$
- RoHS and REACH compliant

Applications

- X-ray and gamma ray detection
- Gamma ray spectroscopy
- Safety and security
- Nuclear medicine
- Positron emission tomography
- Life sciences
- Flow cytometry
- Fluorescence – luminescence measurements
- Time correlated single photon counting
- High energy physics
- Astrophysics

Pad Layout and Soldering Ball Geometry

Figure 2: Bottom View (Left) and Cross Sections (Right)

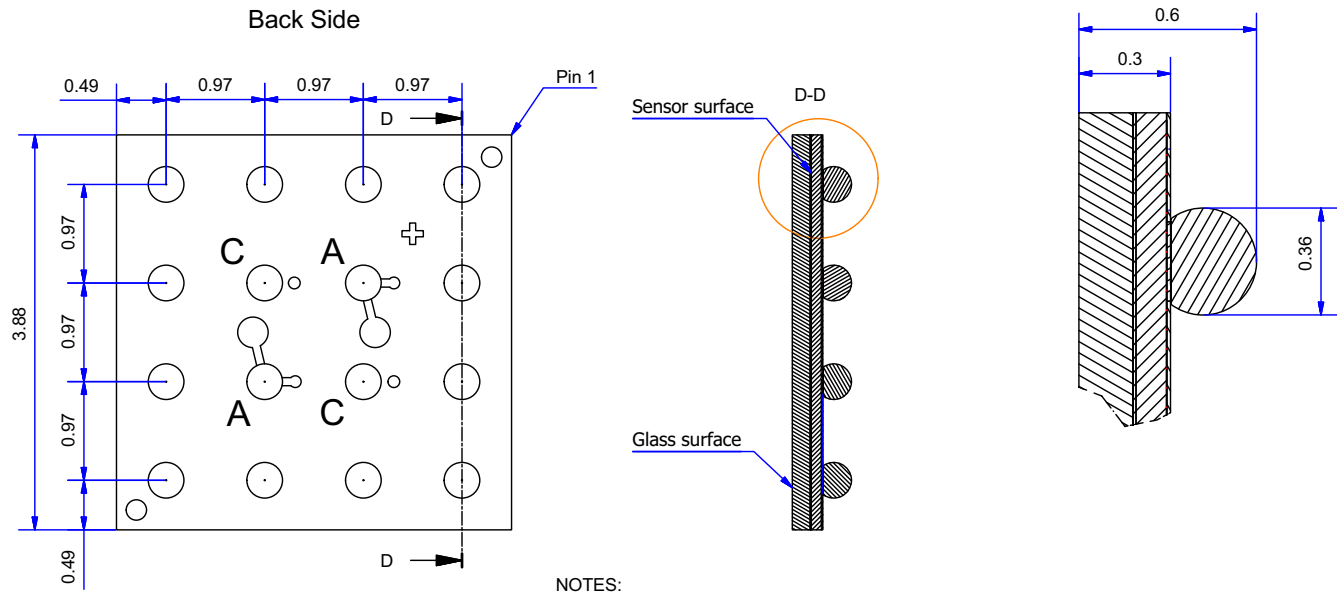

- NOTES:
- 1) Dimensions are in millimeters.
 - 2) Nominal values rounded to two decimal places - Suppression of following zeros.
 - 3) A is anode, C is cathode.

Reflow Soldering Diagram

Figure 3: Recommended Reflow Soldering Profile

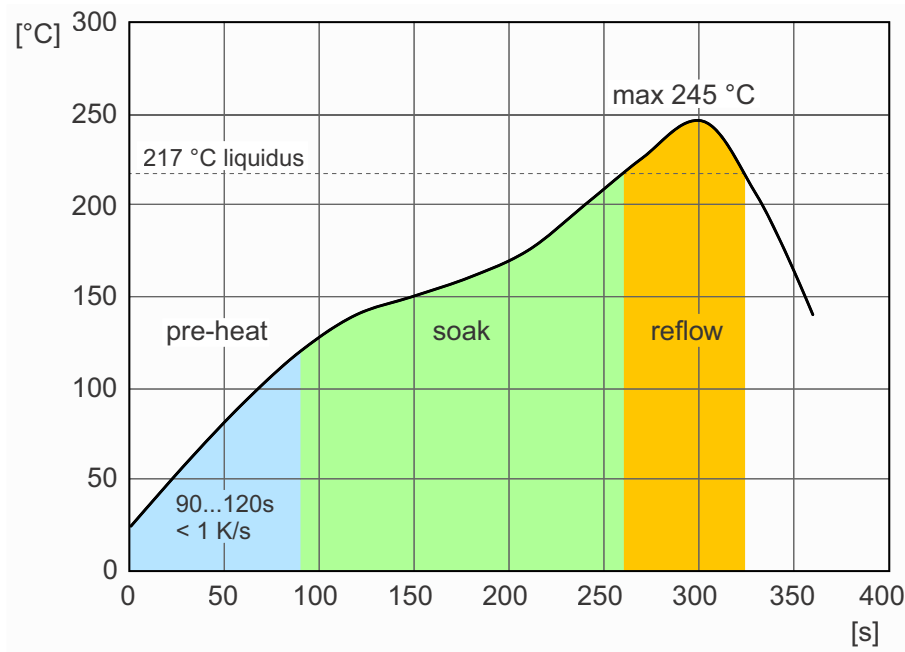

Absolute Maximum Ratings

Stresses in excess of the absolute maximum ratings can cause damage to the devices. Limits apply to each parameter in isolation. Absolute maximum ratings are those values beyond which damage to the device may occur if these limits are exceeded for other than a short period of time.

Parameter	Symbol	Min.	Max.	Units
Storage Temperature	T_{STG}	-20	+60	°C
Operating Temperature	T_A	-20	+50	°C
Soldering Temperature ^{a, b}	T_{SOLD}	—	245	°C
Lead Soldering Time ^{a, b}	t_{SOLD}	—	60	s
Electrostatic Discharge Voltage Capability HBM	ESD_{HBM}	—	2	kV
Electrostatic Discharge Voltage Capability CDM	ESD_{CDM}	—	500	V
Operating Over Voltage	V_{OV}	—	10	V

a. The AFBR-S4N44C013 is reflow-solderable according to solder diagram as shown in [Figure 3](#).

b. According to JEDEC J-STD-020D, the moisture sensitivity classification is MSL3.

Device Specification

Features measured at 25°C unless otherwise specified.

Geometric Features

Parameter	Symbol	Value	Units
Device Area	DA	3.88×3.88	mm ²
Active Area	AA	3.72×3.72	mm ²
Micro Cell Pitch	L_{cell}	30	µm
Number of Micro Cells	N_{cells}	15060	—
Micro Cell Fill Factor	FF	76	%

Optical and Electrical Features

Parameters have been measured for two recommended working points: *Typical* for general purpose applications and *Performance* for best timing performance.

Parameter	Symbol	Min.	Typ.	Max.	Units	Reference Plots
Spectral Range	λ	300	—	900	nm	
Peak Sensitivity Wavelength	λ_{PK}	—	420	—	nm	Figure 4
Breakdown Voltage	V_{BD}	—	26.9	—	V	Figure 6
Temperature Coefficient of Breakdown Voltage	$\Delta V_{BR}/\Delta T$	—	26	—	mV/K	

Parameter	Symbol	Typ. ^a	Perf. ^a	Units	Reference Plots
Photo Detection Efficiency ^b	PDE	43	55	%	Figure 5
Dark Current	I_D	0.5	3.4	μA	Figure 6
Dark Count Rate ^c	DCR	1.7	3.7	Mcps	Figure 7, Figure 10
Dark Count Rate Per Unit Area	DCR_{mm^2}	120	270	kcps/mm ²	
Gain	G	1.6	3.3	$\times 10^6$	Figure 8, Figure 11
Optical Crosstalk	P_{Xtalk}	9	29	%	Figure 9, Figure 12
Afterpulsing Probability	P_{AP}	<1	1	%	Figure 9, Figure 12
Recharge Time Constant ^d	τ_{fall}	55	50	ns	Figure 13
Nominal Terminal Capacitance ^e	C_T	990	760	pF	
Temperature Coefficient of Gain	$\Delta G/\Delta T$	1.1	1.0	$\times 10^4/K$	

- Typical values are measured at 3V above breakdown; performance at 7V above breakdown.
- Measured at peak sensitivity-wavelength. Measurement does not include correlated noise, such as afterpulsing or optical crosstalk.
- Measured at 0.5 p.e. amplitude. Measurement does not include delayed correlated events.
- Measured on $1 \times 1 \text{ mm}^2$ devices with an input impedance of 20Ω .
- Measured using input sine wave with $f = 200 \text{ kHz}$ and $V_{in} = 500 \text{ mV}$.

Reference Plots

Features measured at 25°C unless otherwise specified.

Figure 4: Spectral Sensitivity

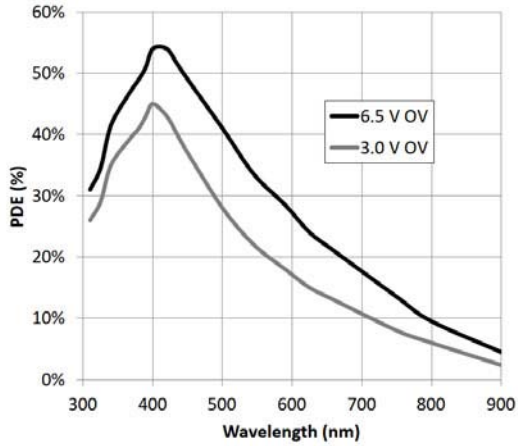

Figure 5: PDE at Peak λ vs. OV

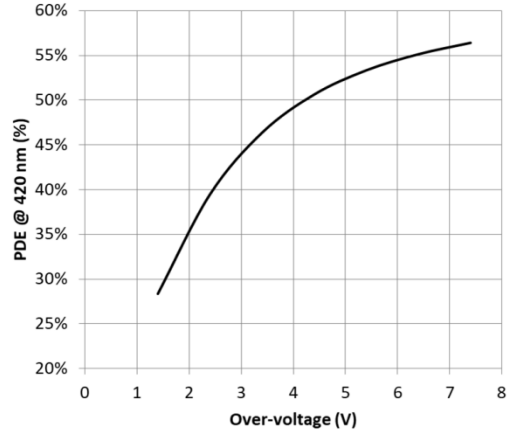

Figure 6: Typical Reverse IV Curve

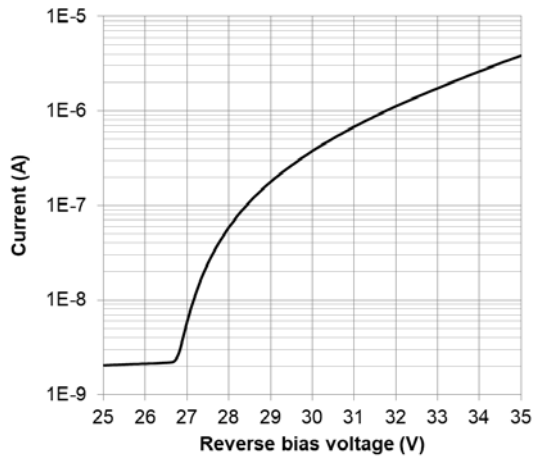

Figure 7: Dark Count Rate vs. OV

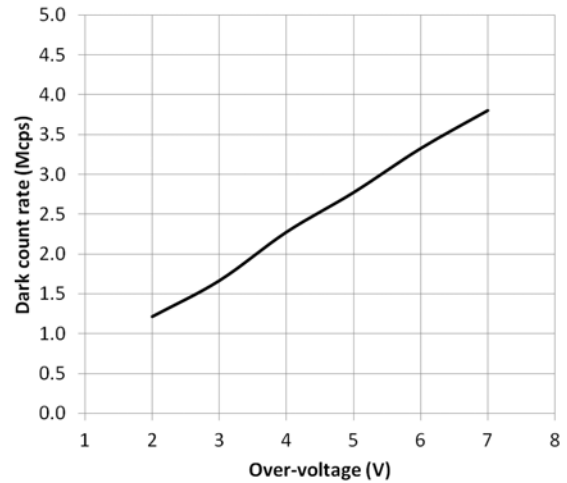

Figure 8: Gain vs.OV

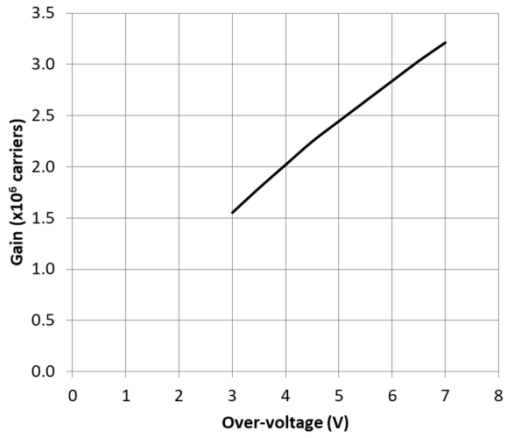

Figure 9: Correlated Noise vs. OV

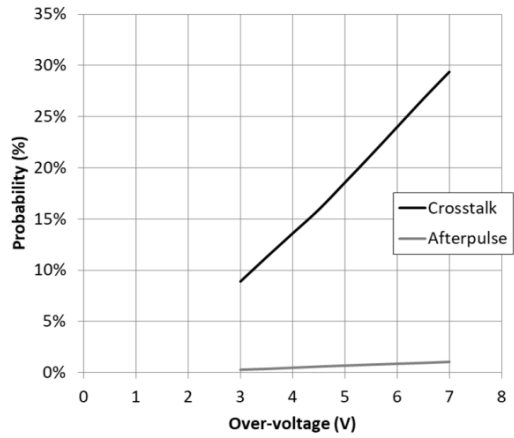

Figure 10: Dark Count Rate vs. PDE at Peak λ

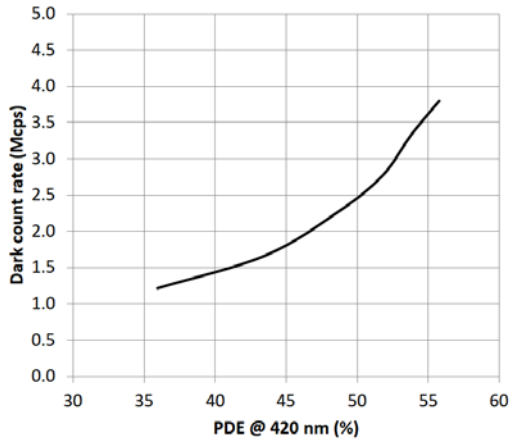

Figure 11: Gain vs. PDE at Peak λ

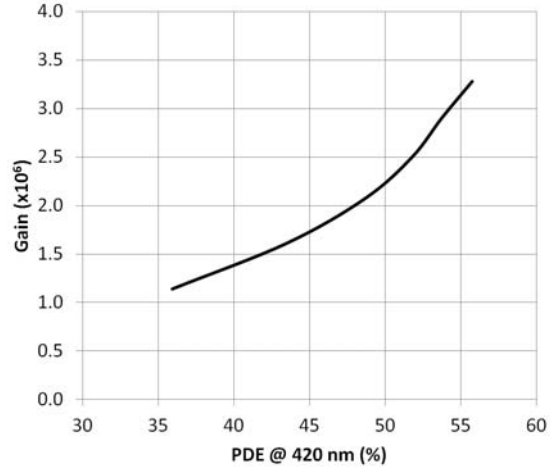

Figure 12: Correlated Noise vs. PDE at Peak λ

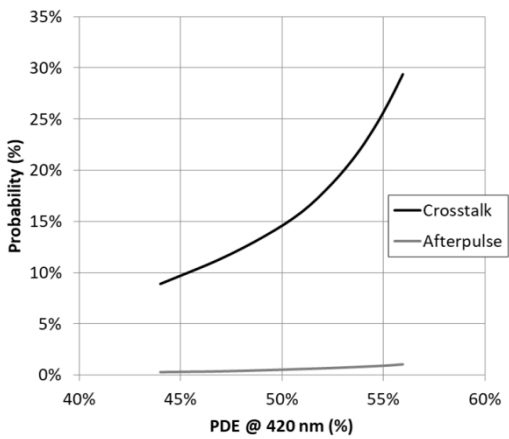
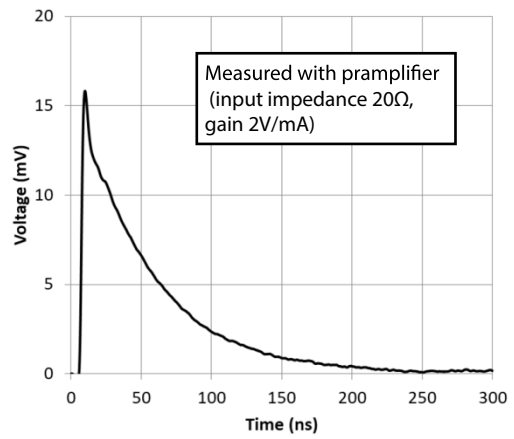

Figure 13: Example Signal Measured at 3V OV



Broadcom, the pulse logo, Connecting everything, Avago Technologies, Avago, and the A logo are among the trademarks of Broadcom and/or its affiliates in the United States, certain other countries, and/or the EU.

Copyright © 2018 Broadcom. All Rights Reserved.

The term “Broadcom” refers to Broadcom Inc. and/or its subsidiaries. For more information, please visit www.broadcom.com.

Broadcom reserves the right to make changes without further notice to any products or data herein to improve reliability, function, or design. Information furnished by Broadcom is believed to be accurate and reliable. However, Broadcom does not assume any liability arising out of the application or use of this information, nor the application or use of any product or circuit described herein, neither does it convey any license under its patent rights nor the rights of others.





Компания «ЭлектроПласт» предлагает заключение долгосрочных отношений при поставках импортных электронных компонентов на взаимовыгодных условиях!

Наши преимущества:

- Оперативные поставки широкого спектра электронных компонентов отечественного и импортного производства напрямую от производителей и с крупнейших мировых складов;
- Поставка более 17-ти миллионов наименований электронных компонентов;
- Поставка сложных, дефицитных, либо снятых с производства позиций;
- Оперативные сроки поставки под заказ (от 5 рабочих дней);
- Экспресс доставка в любую точку России;
- Техническая поддержка проекта, помощь в подборе аналогов, поставка прототипов;
- Система менеджмента качества сертифицирована по Международному стандарту ISO 9001;
- Лицензия ФСБ на осуществление работ с использованием сведений, составляющих государственную тайну;
- Поставка специализированных компонентов (Xilinx, Altera, Analog Devices, Intersil, Interpoint, Microsemi, Aeroflex, Peregrine, Syfer, Eurofarad, Texas Instrument, Miteq, Cobham, E2V, MA-COM, Hittite, Mini-Circuits, General Dynamics и др.);

Помимо этого, одним из направлений компании «ЭлектроПласт» является направление «Источники питания». Мы предлагаем Вам помощь Конструкторского отдела:

- Подбор оптимального решения, техническое обоснование при выборе компонента;
- Подбор аналогов;
- Консультации по применению компонента;
- Поставка образцов и прототипов;
- Техническая поддержка проекта;
- Защита от снятия компонента с производства.



Как с нами связаться

Телефон: 8 (812) 309 58 32 (многоканальный)

Факс: 8 (812) 320-02-42

Электронная почта: org@eplast1.ru

Адрес: 198099, г. Санкт-Петербург, ул. Калинина, дом 2, корпус 4, литера А.