



High-Speed, Low-Power, Single-Supply Multichannel, Video Multiplexer-Amplifiers

General Description

The MAX4310–MAX4315 single-supply mux-amps combine high-speed operation, low-glitch switching, and excellent video specifications. The six products in this family are differentiated by the number of multiplexer inputs and the gain configuration. The MAX4310/MAX4311/MAX4312 integrate 2-/4-/8-channel multiplexers, respectively, with an adjustable gain amplifier optimized for unity-gain stability. The MAX4313/MAX4314/MAX4315 integrate 2-/4-/8-channel multiplexers, respectively, with a +2V/V fixed-gain amplifier. All devices have 40ns channel switching time and low 10mVp-p switching transients, making them ideal for video-switching applications. They operate from a single +4V to +10.5V supply, or from dual supplies of $\pm 2V$ to $\pm 5.25V$, and they feature rail-to-rail outputs and an input common-mode voltage range that extends to the negative supply rail.

The MAX4310/MAX4311/MAX4312 have a -3dB bandwidth of 280MHz/345MHz/265MHz and up to a 460V/ μ s slew rate. The MAX4313/MAX4314/MAX4315, with 150MHz/127MHz/97MHz -3dB bandwidths up to a 540V/ μ s slew rate, and a fixed gain of +2V/V, are ideally suited for driving back-terminated cables. Quiescent supply current is as low as 6.1mA, while low-power shutdown mode reduces supply current to as low as 560 μ A and places the outputs in a high-impedance state. The MAX4310–MAX4315's internal amplifiers maintain an open-loop output impedance of only 8 Ω over the full output voltage range, minimizing the gain error and bandwidth changes under loads typical of most rail-to-rail amplifiers. With differential gain and phase errors of 0.06% and 0.08°, respectively, these devices are ideal for broadcast video applications.

Applications

| | |
|---------------------------------|---------------------|
| Video Signal Multiplexing | Broadcast Video |
| Video Crosspoint Switching | Medical Imaging |
| Flash ADC Input Buffers | Multimedia Products |
| 75 Ω Video Cable Drivers | |
| High-Speed Signal Processing | |

Features

- ◆ Single-Supply Operation Down to +4V
- ◆ 345MHz -3dB Bandwidth (MAX4311)
150MHz -3dB Bandwidth (MAX4313)
- ◆ 540V/ μ s Slew Rate (MAX4313)
- ◆ Low 6.1mA Quiescent Supply Current
- ◆ 40ns Channel Switching Time
- ◆ Ultra-Low 10mVp-p Switching Transient
- ◆ 0.06%/0.08° Differential Gain/Phase Error
- ◆ Rail-to-Rail Outputs: Drives 150 Ω to within 730mV of the Rails
- ◆ Input Common-Mode Range Includes Negative Rail
- ◆ Low-Power Shutdown Mode
- ◆ Available in Space-Saving 8-Pin μ MAX® and 16-Pin QSOP Packages

Ordering Information

| PART | TEMP RANGE | PIN-PACKAGE |
|------------|----------------|--------------|
| MAX4310EUA | -40°C to +85°C | 8 μ MAX |
| MAX4310ESA | -40°C to +85°C | 8 SO |
| MAX4311EEE | -40°C to +85°C | 16 QSOP |
| MAX4311ESD | -40°C to +85°C | 14 Narrow SO |
| MAX4312EEE | -40°C to +85°C | 16 QSOP |
| MAX4312ESE | -40°C to +85°C | 16 Narrow SO |
| MAX4313EUA | -40°C to +85°C | 8 μ MAX |
| MAX4313ESA | -40°C to +85°C | 8 SO |
| MAX4314EEE | -40°C to +85°C | 16 QSOP |
| MAX4314ESD | -40°C to +85°C | 14 Narrow SO |
| MAX4315EEE | -40°C to +85°C | 16 QSOP |
| MAX4315ESE | -40°C to +85°C | 16 Narrow SO |

Pin Configurations and Typical Operating Circuit appear at end of data sheet.

μ Max is a registered trademark of Maxim Integrated Products, Inc.

Selector Guide

| PART | NO. OF INPUT CHANNELS | AMPLIFIER GAIN (V/V) | PIN-PACKAGE |
|---------|-----------------------|----------------------|-------------------------------|
| MAX4310 | 2 | $\geq +1$ | 8-Pin SO/ μ MAX |
| MAX4311 | 4 | $\geq +1$ | 14-Pin Narrow SO, 16-Pin QSOP |
| MAX4312 | 8 | $\geq +1$ | 16-Pin Narrow SO/QSOP |
| MAX4313 | 2 | +2 | 8-Pin SO/ μ MAX |
| MAX4314 | 4 | +2 | 14-Pin Narrow SO, 16-Pin QSOP |
| MAX4315 | 8 | +2 | 16-Pin Narrow SO/QSOP |



High-Speed, Low-Power, Single-Supply Multichannel, Video Multiplexer-Amplifiers

ABSOLUTE MAXIMUM RATINGS

| | | | |
|---|--|---|-----------------|
| Supply Voltage (V _{CC} to V _{EE}) | 12V | 14-Pin SO (derate 8.3mW/°C above +70°C) | 667mW |
| Input Voltage | (V _{EE} - 0.3V) to (V _{CC} + 0.3V) | 16-Pin SO (derate 8.7mW/°C above +70°C) | 696mW |
| All Other Pins | (V _{EE} - 0.3V) to (V _{CC} + 0.3V) | 16-Pin QSOP (derate 8.3mW/°C above +70°C) | 667mW |
| Output Current | ±120mA | Operating Temperature Range | -40°C to +85°C |
| Short-Circuit Duration (V _{OUT} to GND, V _{CC} or V _{EE}) | Continuous | Storage Temperature Range | -65°C to +150°C |
| Continuous Power Dissipation (T _A = +70°C) | | Lead Temperature (soldering, 10s) | +300°C |
| 8-Pin SO (derate 5.9mW/°C above +70°C) | 471mW | | |
| 8-Pin μ MAX (derate 4.1mW/°C above +70°C) | 330mW | | |

Stresses beyond those listed under "Absolute Maximum Ratings" may cause permanent damage to the device. These are stress ratings only, and functional operation of the device at these or any other conditions beyond those indicated in the operational sections of the specifications is not implied. Exposure to absolute maximum rating conditions for extended periods may affect device reliability.

DC ELECTRICAL CHARACTERISTICS

(V_{CC} = +5V, V_{EE} = 0V, $\overline{\text{SHDN}} \geq 4\text{V}$, R_L = ∞ , V_{OUT} = 2.5V, T_A = T_{MIN} to T_{MAX}, unless otherwise noted. Typical values are at T_A = +25°C.)

| PARAMETER | SYMBOL | CONDITIONS | MIN | TYP | MAX | UNITS |
|--------------------------------|-------------------|---|-------------------------------------|-----------------------|------|-------|
| Operating Supply Voltage Range | V _{CC} | Inferred from PSRR test | 4.0 | | 10.5 | V |
| Input Voltage Range | | MAX4310/MAX4311/MAX4312, inferred from CMRR test | 0.035 | V _{CC} - 2.8 | | V |
| | | MAX4313/MAX4314/MAX4315, inferred from output voltage swing | 0.035 | V _{CC} - 2.7 | | |
| Common-Mode Rejection Ratio | CMRR | 0 ≤ V _{CM} ≤ 2.2V, MAX4310/MAX4311/MAX4312 only | 73 | 95 | | dB |
| Input Offset Voltage | V _{OS} | | | ±5.0 | ±20 | mV |
| Input Offset Voltage Drift | TC _{VOS} | | | ±7 | | μV/°C |
| Input Offset Voltage Matching | | | | ±1 | | mV |
| Input Bias Current | I _B | I _{IN} | | 7 | 14 | μA |
| Feedback Bias Current | I _{FB} | I _{FB} , MAX4310/MAX4311/MAX4312 only | | 7 | 14 | μA |
| Input Offset Current | I _{OS} | MAX4310/MAX4311/MAX4312 only | | 0.1 | 2 | μA |
| Common-Mode Input Resistance | R _{IN} | V _{IN} varied over V _{CM} , MAX4310/MAX4311/MAX4312 only | | 3 | | MΩ |
| Differential Input Resistance | R _{IN} | | | 70 | | kΩ |
| Output Resistance | R _{OUT} | MAX4310/MAX4311/ MAX4312 only | Open loop | 8 | | Ω |
| | | | Closed loop, A _v = +1V/V | 0.025 | | |
| | | MAX4313/MAX4314/MAX4315 | | 0.025 | | |
| Disabled Output Resistance | R _{OUT} | MAX4310/MAX4311/MAX4312, open loop | | 35 | | Ω |
| | | MAX4313/MAX4314/MAX4315 | | 1 | | |
| Open-Loop Gain | A _{VOL} | MAX4310/MAX4311/MAX4312, R _L = 150Ω to GND, 0.25V ≤ V _{OUT} ≤ 4.2V | 50 | 59 | | dB |
| Voltage Gain | A _{VCL} | MAX4313/MAX4314/MAX4315, R _L = 150Ω to GND, 0.25V ≤ V _{OUT} ≤ 4.2V | 1.9 | 2.0 | 2.1 | V/V |

High-Speed, Low-Power, Single-Supply Multichannel, Video Multiplexer-Amplifiers

MAX4310-MAX4315

DC ELECTRICAL CHARACTERISTICS (continued)

($V_{CC} = +5V$, $V_{EE} = 0V$, $\overline{SHDN} \geq 4V$, $R_L = \infty$, $V_{OUT} = 2.5V$, $T_A = T_{MIN}$ to T_{MAX} , unless otherwise noted. Typical values are at $T_A = +25^\circ C$.)

| PARAMETER | SYMBOL | CONDITIONS | | MIN | TYP | MAX | UNITS |
|--|-----------|-------------------------------|-------------------|--------------|----------|--------------|---------|
| Output Voltage Swing | V_{OUT} | $R_L = 150\Omega$ | $V_{CC} - V_{OH}$ | | 0.73 | 0.9 | V |
| | | | $V_{OL} - V_{EE}$ | | 0.03 | 0.06 | |
| | | $R_L = 10k\Omega$ | $V_{CC} - V_{OH}$ | | 0.25 | 0.4 | |
| | | | $V_{OL} - V_{EE}$ | | 0.04 | 0.07 | |
| Output Current | I_{OUT} | $R_L = 30\Omega$ | | ± 75 | ± 95 | | mA |
| Power-Supply Rejection Ratio | PSRR | $V_{CC} = 4.0V$ to $10.5V$ | | 52 | 63 | | dB |
| Quiescent Supply Current | I_{CC} | MAX4310/MAX4313 | | | 6.1 | 7.8 | mA |
| | | MAX4311/MAX4314 | | | 6.9 | 8.8 | |
| | | MAX4312/MAX4315 | | | 7.4 | 9.4 | |
| Shutdown Supply Current | | $\overline{SHDN} \leq V_{IL}$ | | | 560 | 750 | μA |
| LOGIC CHARACTERISTICS (\overline{SHDN} , A0, A1, A2) | | | | | | | |
| Logic-Low Threshold | V_{IL} | | | | | $V_{EE} + 1$ | V |
| Logic-High Threshold | V_{IH} | | | $V_{CC} - 1$ | | | V |
| Logic-Low Input Current | I_{IL} | $V_{IL} \leq V_{EE} + 1V$ | | -500 | -320 | | μA |
| Logic-High Input Current | I_{IH} | $V_{IH} \geq V_{CC} - 1V$ | | | 0.3 | 5 | μA |

AC ELECTRICAL CHARACTERISTICS

($V_{CC} = +5V$, $V_{EE} = 0V$, $\overline{SHDN} \geq 4V$, $R_L = 150\Omega$, $V_{CM} = 1.5V$, $A_{VCL} = +1V/V$ (MAX4310/MAX4311/MAX4312), $A_{VCL} = +2V/V$ (MAX4313/MAX4314/MAX4315), $T_A = +25^\circ C$, unless otherwise noted.)

| PARAMETER | SYMBOL | CONDITIONS | | MIN | TYP | MAX | UNITS |
|------------------|-----------------|----------------------|---------|-----|-----|-----|-------|
| -3dB Bandwidth | $BW_{(-3dB)}$ | $V_{OUT} = 100mVp-p$ | MAX4310 | | 280 | | MHz |
| | | | MAX4311 | | 345 | | |
| | | | MAX4312 | | 265 | | |
| | | | MAX4313 | | 150 | | |
| | | | MAX4314 | | 127 | | |
| | | | MAX4315 | | 97 | | |
| -0.1dB Bandwidth | $BW_{(-0.1dB)}$ | $V_{OUT} = 100mVp-p$ | MAX4310 | | 60 | | MHz |
| | | | MAX4311 | | 40 | | |
| | | | MAX4312 | | 35 | | |
| | | | MAX4313 | | 40 | | |
| | | | MAX4314 | | 78 | | |
| | | | MAX4315 | | 46 | | |

High-Speed, Low-Power, Single-Supply Multichannel, Video Multiplexer-Amplifiers

AC ELECTRICAL CHARACTERISTICS (continued)

($V_{CC} = +5V$, $V_{EE} = 0V$, $\overline{SHDN} \geq 4V$, $R_L = 150\Omega$, $V_{CM} = 1.5V$, $A_{VCL} = +1V/V$ (MAX4310/MAX4311/MAX4312), $A_{VCL} = +2V/V$ (MAX4313/MAX4314/MAX4315), $T_A = +25^\circ C$, unless otherwise noted.)

| PARAMETER | SYMBOL | CONDITIONS | | MIN | TYP | MAX | UNITS |
|-----------------------------|--------|---|---------------------------------|-------------|------|-----|---------|
| Full-Power Bandwidth | FPBW | $V_{OUT} = 2V_{p-p}$ | MAX4310 | | 110 | | MHz |
| | | | MAX4311 | | 100 | | |
| | | | MAX4312 | | 80 | | |
| | | | MAX4313 | | 40 | | |
| | | | MAX4314 | | 90 | | |
| | | | MAX4315 | | 70 | | |
| Slew Rate | SR | $V_{OUT} = 2V_{p-p}$ | MAX4310 | | 460 | | |
| | | | MAX4311 | | 430 | | |
| | | | MAX4312 | | 345 | | |
| | | | MAX4313 | | 540 | | |
| | | | MAX4314 | | 430 | | |
| | | | MAX4315 | | 310 | | |
| Settling Time to 0.1% | t_s | $V_{OUT} = 2V_{p-p}$ | MAX4310/MAX4311/MAX4312 | | 42 | | ns |
| | | | MAX4313/MAX4314/MAX4315 | | 25 | | |
| Gain Matching | | Matching between channels over -3dB bandwidth | | | 0.05 | | dB |
| Differential Gain Error | DG | $A_{VCL} = +1V/V$, $R_L = 150\Omega$ to $V_{CC}/2$ | MAX4310/MAX4311/ MAX4312 | | 0.06 | | % |
| | | $R_L = 150\Omega$ to $V_{CC}/2$ | MAX4313/MAX4314/ MAX4315 | | 0.09 | | |
| Differential Phase Error | DG | $A_{VCL} = +1V/V$, $R_L = 150\Omega$ to $V_{CC}/2$ | MAX4310/MAX4311/ MAX4312 | | 0.08 | | degrees |
| | | $R_L = 150\Omega$ to $V_{CC}/2$ | MAX4313/MAX4314/ MAX4315 | | 0.03 | | |
| Spurious-Free Dynamic Range | SFDR | $V_{OUT} = 2V_{p-p}$ | MAX4310/ MAX4311/ MAX4312 | $f = 3kHz$ | -89 | | dBc |
| | | | | $f = 2kHz$ | -80 | | |
| | | | | $f = 20kHz$ | -47 | | |
| | | | MAX4313/ MAX4314/ MAX4315 | $f = 3kHz$ | -95 | | |
| | | | | $f = 2kHz$ | -72 | | |
| | | | | $f = 20kHz$ | -47 | | |
| Second Harmonic Distortion | | $f = 1MHz$, $V_{OUT} = 2V_{p-p}$ | MAX4310/MAX4311/MAX4312 | | -85 | | dBc |
| | | | MAX4313/MAX4314/MAX4315 | | -76 | | |
| Third Harmonic Distortion | | $f = 1MHz$, $V_{OUT} = 2V_{p-p}$ | MAX4310/MAX4311/MAX4312 | | -88 | | dBc |
| | | | MAX4313/MAX4314/MAX4315 | | -95 | | |
| Total Harmonic Distortion | THD | $f = 1MHz$, $V_{OUT} = 2V_{p-p}$ | MAX4310/MAX4311/MAX4312 | | -83 | | dBc |
| | | | MAX4313/MAX4314/MAX4315 | | -76 | | |

High-Speed, Low-Power, Single-Supply Multichannel, Video Multiplexer-Amplifiers

MAX4310-MAX4315

AC ELECTRICAL CHARACTERISTICS (continued)

($V_{CC} = +5V$, $V_{EE} = 0V$, $\overline{SHDN} \geq 4V$, $R_L = 150\Omega$, $V_{CM} = 1.5V$, $A_{VCL} = +1V/V$ (MAX4310/MAX4311/MAX4312), $A_{VCL} = +2V/V$ (MAX4313/MAX4314/MAX4315), $T_A = +25^\circ C$, unless otherwise noted.)

| PARAMETER | SYMBOL | CONDITIONS | MIN | TYP | MAX | UNITS |
|----------------------------------|-----------|--|-----|-----|-----|-----------------|
| All-Hostile Crosstalk | | f = 10MHz, $V_{IN} = 2V_{p-p}$ | | | | dB |
| | | MAX4310/MAX4313 | | -95 | | |
| | | MAX4311/MAX4314 | | -60 | | |
| | | MAX4312/MAX4315 | | -52 | | |
| Off-Isolation | | $\overline{SHDN} = 0$, f = 10MHz, $V_{IN} = 2V_{p-p}$ | | -82 | | dB |
| Output Impedance | Z_{OUT} | f = 10MHz | | 3 | | Ω |
| Input Capacitance | C_{IN} | Channel on or off | | 2 | | pF |
| Input Voltage-Noise Density | e_n | f = 10kHz | | 14 | | nV/ \sqrt{Hz} |
| Input Current-Noise Density | i_n | f = 10kHz | | 1.3 | | pA/ \sqrt{Hz} |
| SWITCHING CHARACTERISTICS | | | | | | |
| Channel Switching Time | t_{SW} | | | 40 | | ns |
| Enable Time from Shutdown | t_{ON} | | | 50 | | ns |
| Disable Time to Shutdown | t_{OFF} | | | 120 | | ns |
| Switching Transient | | | | 10 | | mVp-p |

Typical Operating Characteristics

($V_{CC} = +5V$, $V_{EE} = 0V$, $\overline{SHDN} \geq 4V$, $R_L = 150\Omega$ to $V_{CC}/2$, $V_{CM} = 1.5V$, $A_{VCL} = +1V/V$ (MAX4310/MAX4311/MAX4312), $A_{VCL} = +2V/V$ (MAX4313/MAX4314/MAX4315), $T_A = +25^\circ C$, unless otherwise noted.)

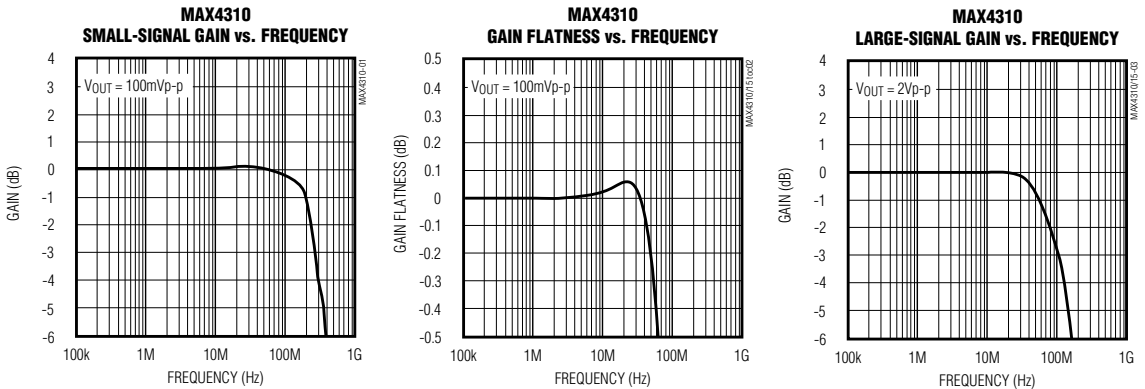

High-Speed, Low-Power, Single-Supply Multichannel, Video Multiplexer-Amplifiers

Typical Operating Characteristics (continued)

($V_{CC} = +5V$, $V_{EE} = 0V$, $\overline{SHDN} \geq 4V$, $R_L = 150\Omega$ to $V_{CC}/2$, $V_{CM} = 1.5V$, $A_{VCL} = +1V/V$ (MAX4310/MAX4311/MAX4312), $A_{VCL} = +2V/V$ (MAX4313/MAX4314/MAX4315), $T_A = +25^\circ C$, unless otherwise noted.)

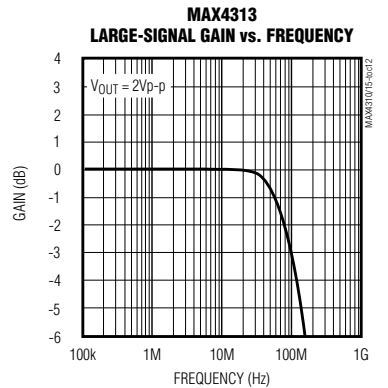
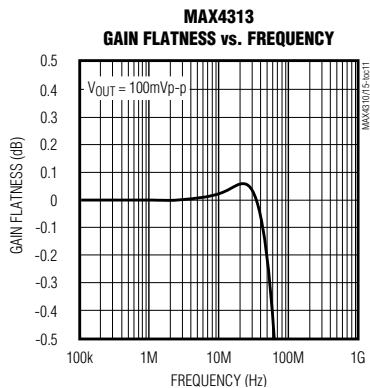
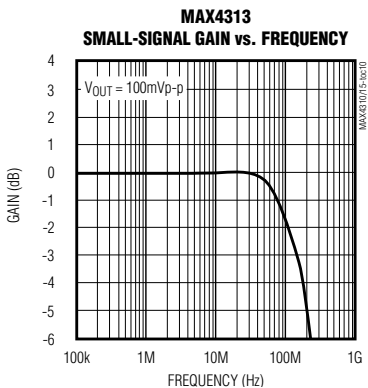
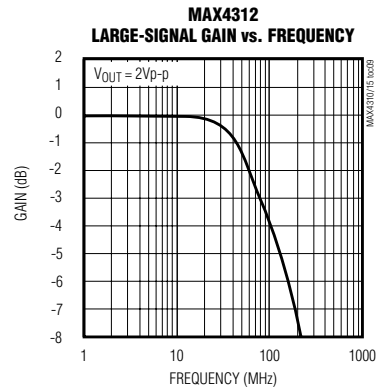
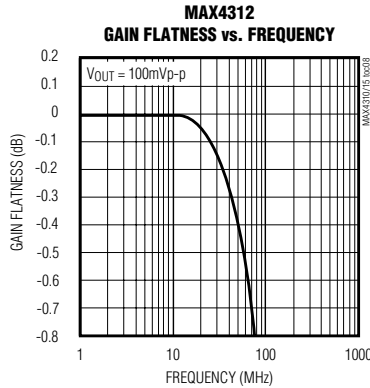
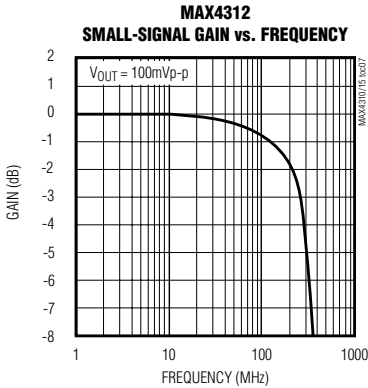
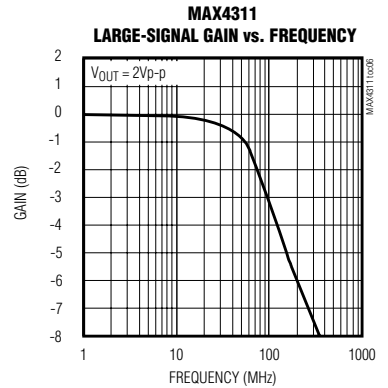
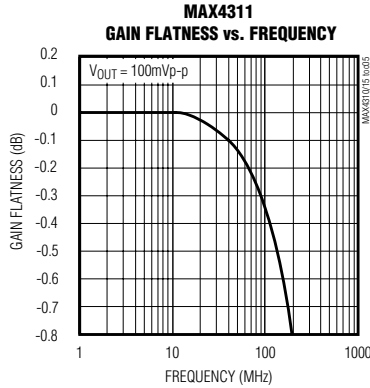
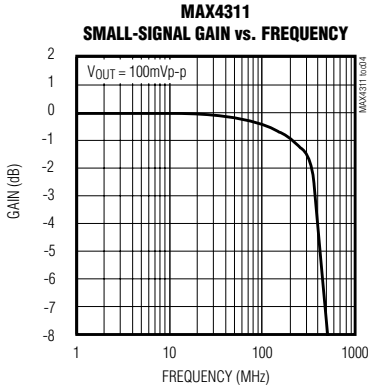

High-Speed, Low-Power, Single-Supply Multichannel, Video Multiplexer-Amplifiers

Typical Operating Characteristics (continued)

($V_{CC} = +5V$, $V_{EE} = 0V$, $\overline{SHDN} \geq 4V$, $R_L = 150\Omega$ to $V_{CC}/2$, $V_{CM} = 1.5V$, $A_{VCL} = +1V/V$ (MAX4310/MAX4311/MAX4312), $A_{VCL} = +2V/V$ (MAX4313/MAX4314/MAX4315), $T_A = +25^\circ C$, unless otherwise noted.)

MAX4310-MAX4315

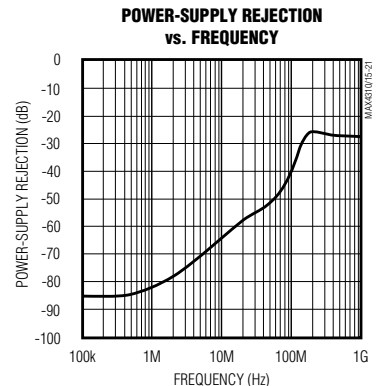
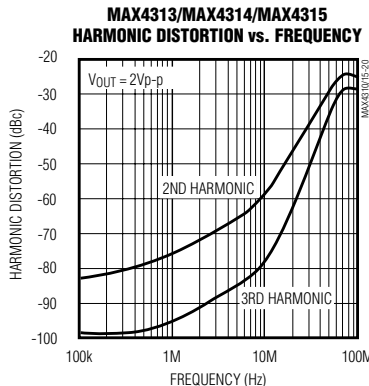
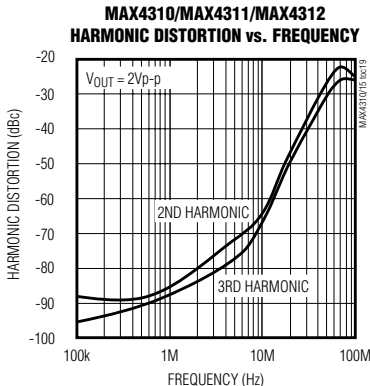
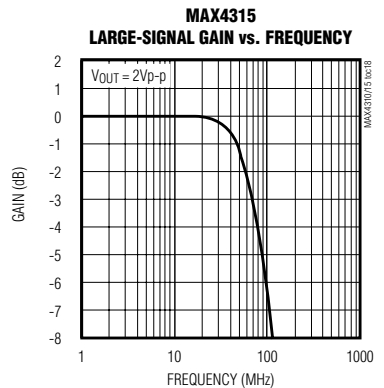
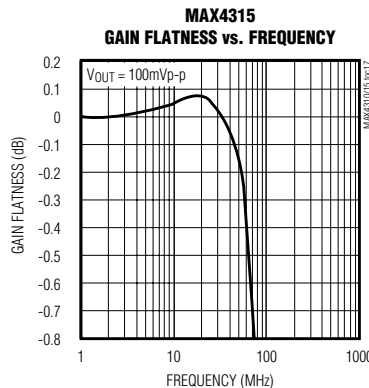
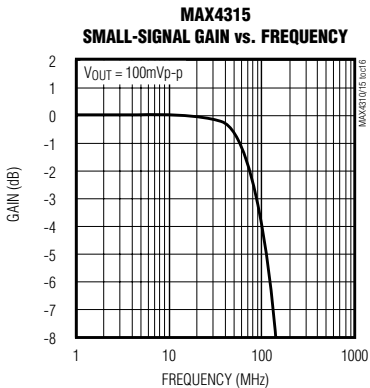
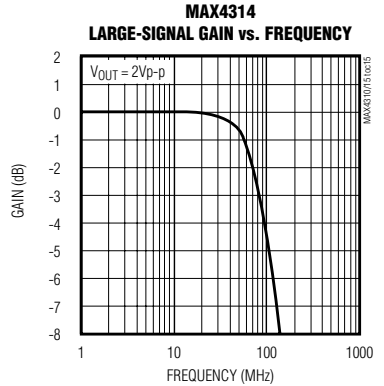
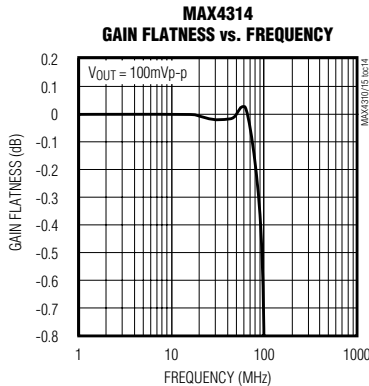
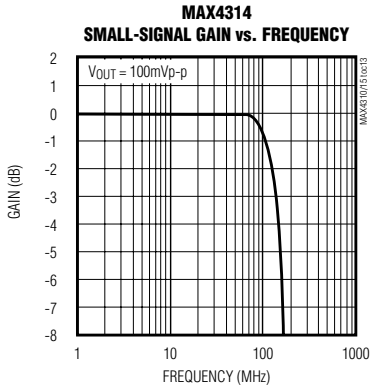

High-Speed, Low-Power, Single-Supply Multichannel, Video Multiplexer-Amplifiers

Typical Operating Characteristics (continued)

($V_{CC} = +5V$, $V_{EE} = 0V$, $\overline{SHDN} \geq 4V$, $R_L = 150\Omega$ to $V_{CC}/2$, $V_{CM} = 1.5V$, $AV_{CL} = +1V/V$ (MAX4310/MAX4311/MAX4312), $AV_{CL} = +2V/V$ (MAX4313/MAX4314/MAX4315), $T_A = +25^\circ C$, unless otherwise noted.)

**MAX4310/MAX4311/MAX4312
COMMON-MODE REJECTION vs. FREQUENCY**

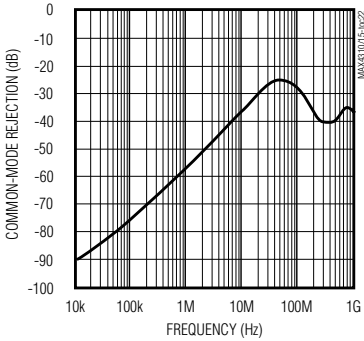

OFF-ISOLATION vs. FREQUENCY

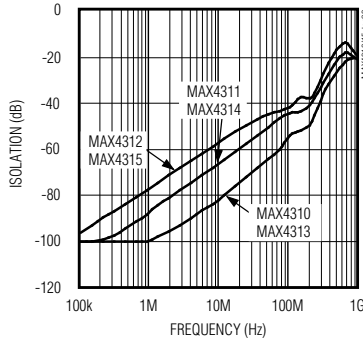

**MAX4310/MAX4313
ALL-HOSTILE CROSSTALK vs. FREQUENCY**

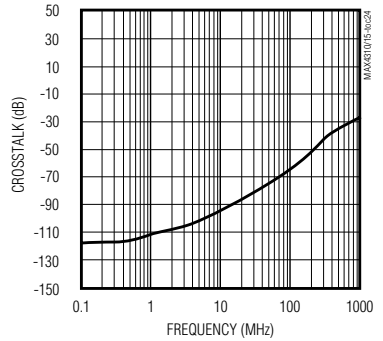

**MAX4312/MAX4315
ALL-HOSTILE CROSSTALK vs. FREQUENCY**

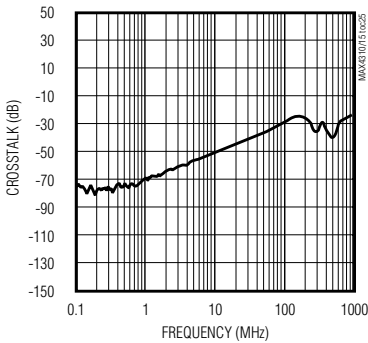

**MAX4311/MAX4314
ALL-HOSTILE CROSSTALK vs. FREQUENCY**

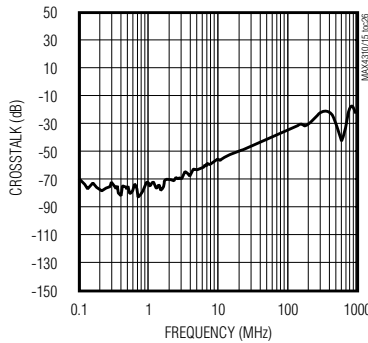

OUTPUT IMPEDANCE vs. FREQUENCY

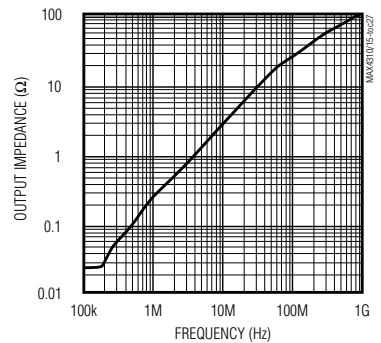

VOLTAGE-NOISE DENSITY vs. FREQUENCY (INPUT REFERRED)

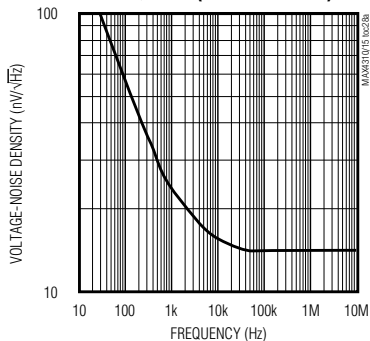

CURRENT-NOISE DENSITY vs. FREQUENCY (INPUT REFERRED)

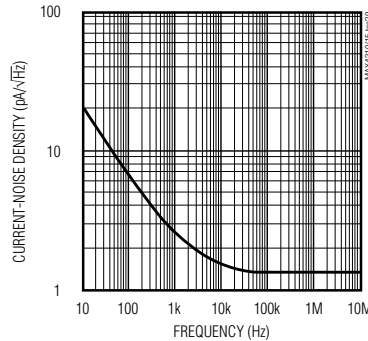

**MAX4310
LARGE-SIGNAL PULSE RESPONSE**

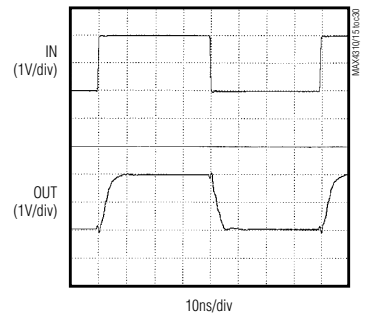

High-Speed, Low-Power, Single-Supply Multichannel, Video Multiplexer-Amplifiers

Typical Operating Characteristics (continued)

($V_{CC} = +5V$, $V_{EE} = 0V$, $\overline{SHDN} \geq 4V$, $R_L = 150\Omega$ to $V_{CC}/2$, $V_{CM} = 1.5V$, $A_{VCL} = +1V/V$ (MAX4310/MAX4311/MAX4312), $A_{VCL} = +2V/V$ (MAX4313/MAX4314/MAX4315), $T_A = +25^\circ C$, unless otherwise noted.)

**MAX4311
LARGE-SIGNAL PULSE RESPONSE**

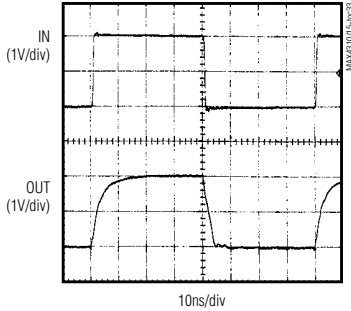

**MAX4312
LARGE-SIGNAL PULSE RESPONSE**

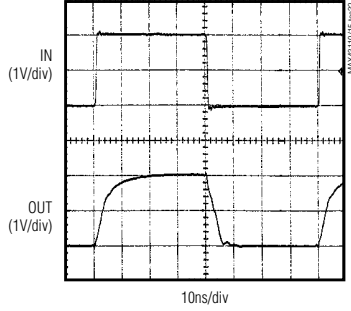

**MAX4313
LARGE-SIGNAL PULSE RESPONSE**

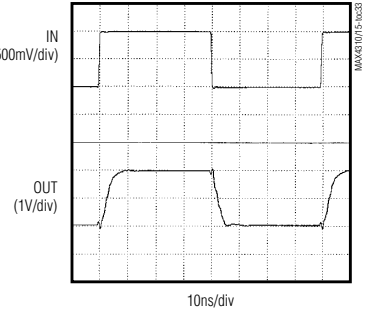

**MAX4314
LARGE-SIGNAL PULSE RESPONSE**

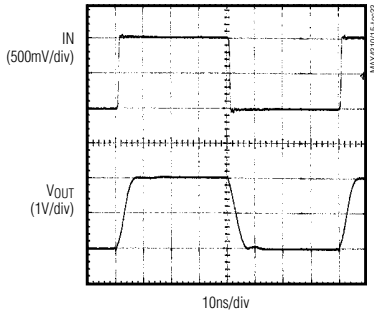

**MAX4315
LARGE-SIGNAL PULSE RESPONSE**

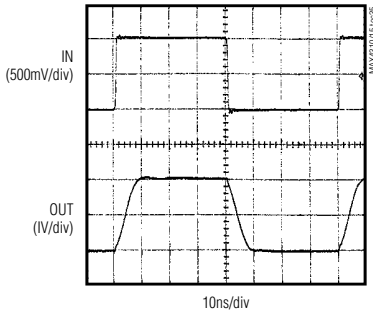

**MAX4310
SMALL-SIGNAL PULSE RESPONSE**

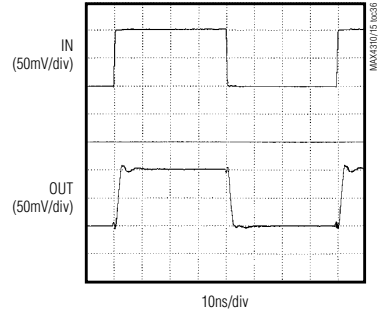

**MAX4311
SMALL-SIGNAL PULSE RESPONSE**

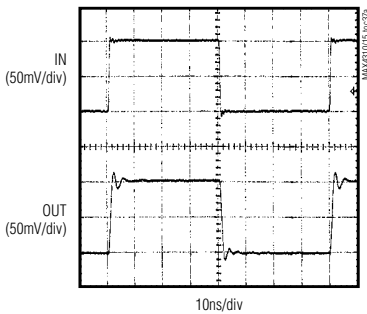

**MAX4312
SMALL-SIGNAL PULSE RESPONSE**

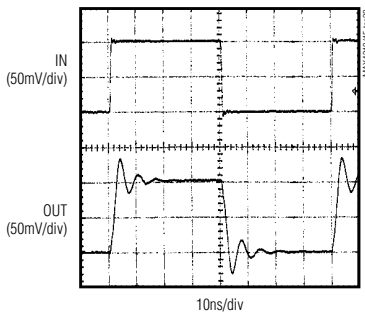

**MAX4313
SMALL-SIGNAL PULSE RESPONSE**

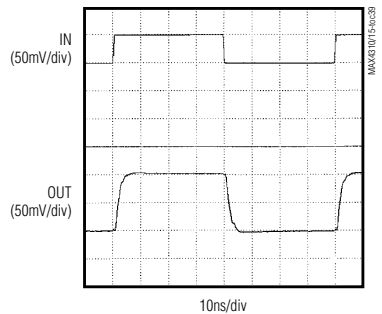

MAX4310-MAX4315

High-Speed, Low-Power, Single-Supply Multichannel, Video Multiplexer-Amplifiers

Typical Operating Characteristics (continued)

($V_{CC} = +5V$, $V_{EE} = 0V$, $\overline{SHDN} \geq 4V$, $R_L = 150\Omega$ to $V_{CC}/2$, $V_{CM} = 1.5V$, $A_{VCL} = +1V/V$ (MAX4310/MAX4311/MAX4312), $A_{VCL} = +2V/V$ (MAX4313/MAX4314/MAX4315), $T_A = +25^\circ C$, unless otherwise noted.)

**MAX4314
SMALL-SIGNAL PULSE RESPONSE**

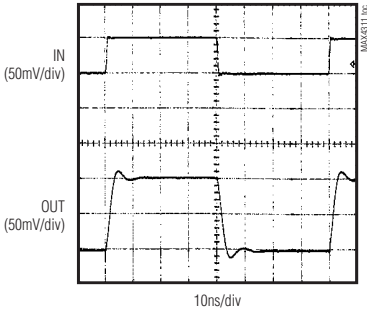

**MAX4315
SMALL-SIGNAL PULSE RESPONSE**

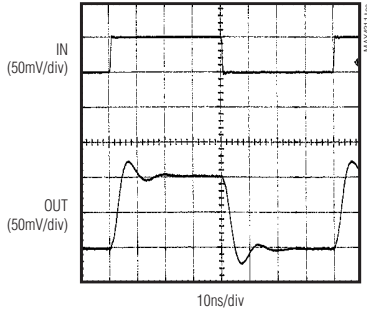

**MAX4310
SMALL-SIGNAL PULSE RESPONSE
($C_L = 10pF$)**

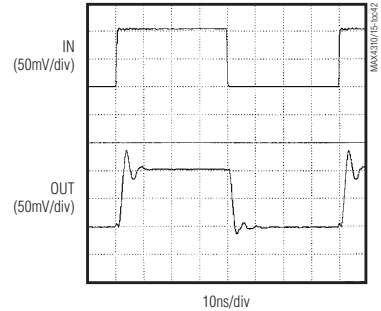

**MAX4310
SMALL-SIGNAL PULSE RESPONSE
($C_L = 22pF$)**

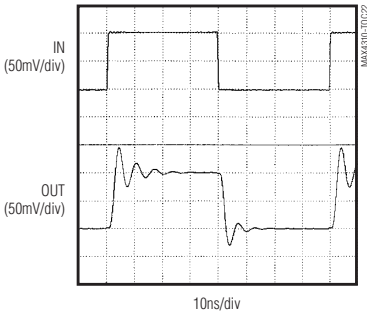

**MAX4313
SMALL-SIGNAL PULSE RESPONSE
($C_L = 10pF$)**

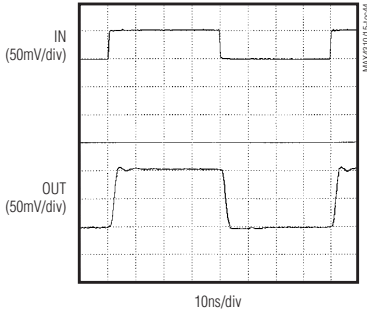

**MAX4313
SMALL-SIGNAL PULSE RESPONSE
($C_L = 22pF$)**

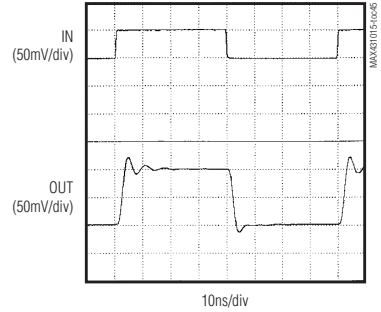

CHANNEL-SWITCHING TRANSIENT

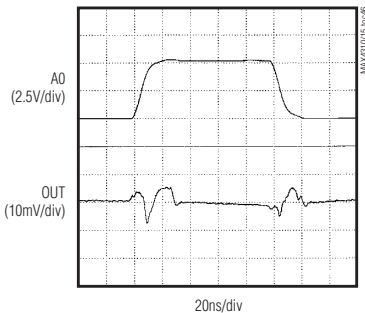

SHUTDOWN RESPONSE TIME

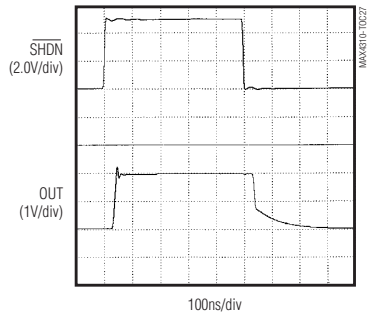

High-Speed, Low-Power, Single-Supply Multichannel, Video Multiplexer-Amplifiers

Pin Description

| PIN | | | | | | | | NAME | FUNCTION |
|--------------------|---------|----------------|--------------------|--------------------|---------|----------------|--------------------|--------------------------|---|
| MAX4310 SO/μMAX | MAX4311 | | MAX4312 SO/QSOP | MAX4313 SO/μMAX | MAX4314 | | MAX4315 SO/QSOP | | |
| | SO | QSOP | | | SO | QSOP | | | |
| 1 | 2 | 2 | 3 | 1 | 2 | 2 | 3 | A0 | Channel Address Logic Input 0 |
| — | 1 | 1 | 2 | — | 1 | 1 | 2 | A1 | Channel Address Logic Input 1 |
| — | — | — | 1 | — | — | — | 1 | A2 | Channel Address Logic Input 2 |
| 2 | 12 | 14 | 14 | 2 | 12 | 14 | 14 | $\overline{\text{SHDN}}$ | Shutdown Input |
| 3 | 4 | 4 | 4 | 3 | 4 | 4 | 4 | V _{CC} | Positive Power Supply |
| 4 | 5 | 5 | 5 | 4 | 5 | 5 | 5 | IN0 | Amplifier Input 0 |
| 5 | 7 | 7 | 6 | 5 | 7 | 7 | 6 | IN1 | Amplifier Input 1 |
| — | 8 | 10 | 7 | — | 8 | 10 | 7 | IN2 | Amplifier Input 2 |
| — | 10 | 12 | 8 | — | 10 | 12 | 8 | IN3 | Amplifier Input 3 |
| — | — | — | 9 | — | — | — | 9 | IN4 | Amplifier Input 4 |
| — | — | — | 10 | — | — | — | 10 | IN5 | Amplifier Input 5 |
| — | — | — | 11 | — | — | — | 11 | IN6 | Amplifier Input 6 |
| — | — | — | 12 | — | — | — | 12 | IN7 | Amplifier Input 7 |
| 6 | 11 | 13 | 13 | 6 | 11 | 13 | 13 | V _{EE} | Negative Power Supply. Ground for single-supply operation. |
| 7 | 13 | 15 | 15 | — | — | — | — | FB | Amplifier Feedback Input |
| — | — | — | — | 7 | 13 | 15 | 15 | GND | Ground |
| 8 | 14 | 16 | 16 | 8 | 14 | 16 | 16 | OUT | Amplifier Output |
| — | 3, 6, 9 | 3, 6, 8, 9, 11 | — | — | 3, 6, 9 | 3, 6, 8, 9, 11 | — | N.C. | Not connected. Tie to ground plane for optimal performance. |

MAX4310-MAX4315

High-Speed, Low-Power, Single-Supply Multichannel, Video Multiplexer-Amplifiers

Detailed Description

The MAX4310/MAX4311/MAX4312 combine 2-channel, 4-channel, or 8-channel multiplexers, respectively, with an adjustable-gain output amplifier optimized for closed-loop gains of +1V/V (0dB) or greater. The MAX4313/MAX4314/MAX4315 combine 2-channel, 4-channel, or 8-channel multiplexers, respectively, with a +2V/V (6dB) fixed-gain amplifier, optimized for driving back-terminated cables. These devices operate from a single supply voltage of +4V to +10.5V, or from dual supplies of ±2V to ±5.25V. The outputs may be placed in a high-impedance state and the supply current minimized by forcing the SHDN pin low. The input multiplexers feature short 40ns channel-switching times and small 10mVp-p switching transients. The input capacitance remains constant at 1pF whether the channel is on or off, providing a predictable input impedance to the signal source. These devices feature single-supply, rail-to-rail, voltage-feedback output amplifiers that achieve up to 540V/μs slew rates and up to 345MHz -3dB bandwidths. These devices also feature excellent harmonic distortion and differential gain/phase performance.

Applications Information

Rail-to-Rail Outputs, Ground-Sensing Input

The input common-mode range extends from the negative supply rail to $V_{CC} - 2.7V$ with excellent common-mode rejection. Beyond this range, multiplexer switching times may increase and the amplifier output is a nonlinear function of the input, but does not undergo phase reversal or latchup.

The output swings to within 250mV of V_{CC} and 40mV of V_{EE} with a 10kΩ load. With a 150Ω load to ground, the output swings from 30mV above V_{EE} to within 730mV of

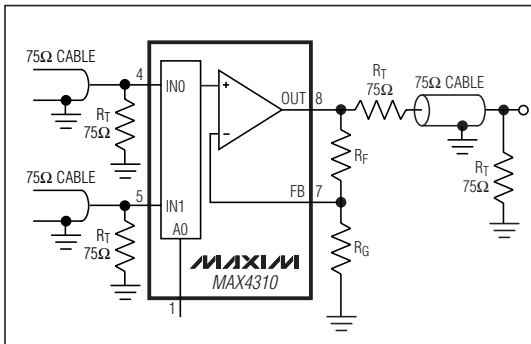

Figure 1. MAX4310 Noninverting Gain Configuration

the supply rail. Local feedback around the output stage ensures low open-loop output impedance to reduce gain sensitivity to load variations. This feedback also produces demand-driven bias current to the output transistors for ±95mA drive capability while constraining total supply current to only 6.1mA.

Feedback and Gain Resistor Selection (MAX4310/MAX4311/MAX4312)

Select the MAX4310/MAX4311/MAX4312 gain-setting feedback (R_F) and input (R_G) resistors to fit your application. Large resistor values increase voltage noise and interact with the amplifier's input and PC board capacitance. This can generate undesirable poles and zeros, and can decrease bandwidth or cause oscillations. For example, a noninverting gain of +2V/V configuration ($R_F = R_G$) using 1kΩ resistors, combined with 2pF of input capacitance and 1pF of PC board capacitance, causes a pole at 159MHz. Since this pole is within the amplifier bandwidth, it jeopardizes stability. Reducing the 1kΩ resistors to 100Ω extends the pole frequency to 1.59GHz, but could limit output swing by adding 200Ω in parallel with the amplifier's load resistor.

Table 1 shows suggested R_F and R_G values for the MAX4310/MAX4311/MAX4312 when operating in the non-inverting configuration (shown in Figure 1). These values provide optimal AC response using surface-mount resistors and good layout techniques, as discussed in the *Layout and Power-Supply Bypassing* section.

Stray capacitance at the FB pin causes feedback resistor decoupling and produces peaking in the frequency-response curve. Keep the capacitance at FB as low as possible by using surface-mount resistors and by avoiding the use of a ground plane beneath or beside these resistors and the FB pin. Some capacitance is unavoidable; if necessary, its effects can be neutralized by adjusting R_F . Use 1% resistors to maintain consistency over a wide range of production lots.

Table 1. Bandwidth and Gain with Suggested Gain-Setting resistors (MAX4310/MAX4311/MAX4312)

| GAIN (V/V) | GAIN (d B) | R_F (Ω) | R_G (Ω) | -3dB BW (MHz) | 0.1dB BW (MHz) |
|------------|------------|-----------|-----------|---------------|----------------|
| 1 | 0 | 0 | ∞ | 280 | 60 |
| 2 | 6 | 500 | 500 | 80 | 30 |
| 5 | 14 | 500 | 120 | 20 | 4 |
| 10 | 20 | 500 | 56 | 10 | 2 |

High-Speed, Low-Power, Single-Supply Multichannel, Video Multiplexer-Amplifiers

MAX4310-MAX4315

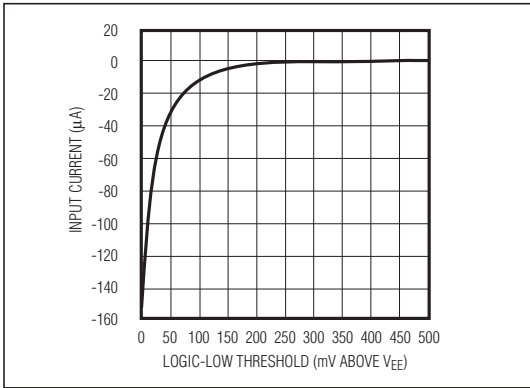

Figure 2. Logic-Low Input Current vs. V_{IL} (\overline{SHDN} , A0, A1, A2)

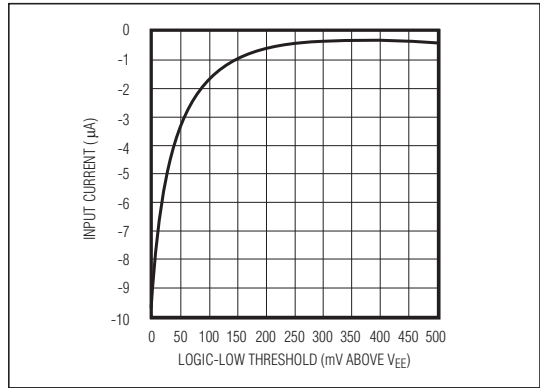

Figure 4. Logic-Low Input Current vs. V_{IL} with 10kΩ Series Resistor

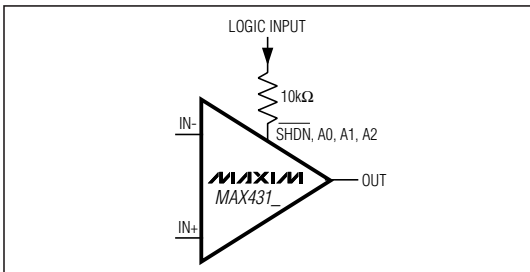

Figure 3. Circuit to Reduce Logic-Low Input Current

Low-Power Shutdown Mode

All parts feature a low-power shutdown mode that is activated by driving the \overline{SHDN} input low. Placing the amplifier in shutdown mode reduces the quiescent supply current to 560µA and places the output into a high-impedance state, typically 35kΩ. By tying the outputs of several devices together and disabling all but one of the paralleled amplifiers' outputs, multiple devices may be paralleled to construct larger switch matrices.

For MAX4310/MAX4311/MAX4312 application circuits operating with a closed-loop gain of +2V/V or greater, consider the external-feedback network impedance of all devices used in the mux application when calculating the total load on the output amplifier of the active device. The MAX4313/MAX4314/MAX4315 have a fixed gain of +2V/V that is internally set with two 500Ω thin-film resistors. The impedance of the internal feedback resistors must be taken into account when operating multiple MAX4313/MAX4314/MAX4315s in large multiplexer applications. For normal operation, drive \overline{SHDN} high. If the shutdown function is not used, connect \overline{SHDN} to V_{CC} .

Layout and Power-Supply Bypassing

The MAX4310-MAX4315 have very high bandwidths and consequently require careful board layout, including the possible use of constant-impedance microstrip or stripline techniques.

To realize the full AC performance of these high-speed amplifiers, pay careful attention to power-supply bypassing and board layout. The PC board should have at least two layers: a signal and power layer on one side, and a large, low-impedance ground plane on the other side. The ground plane should be as free of voids as possible, with one exception: the feedback (FB) should have as low a capacitance to ground as possible. Therefore, layers that do not incorporate a signal or power trace should not have a ground plane.

Whether or not a constant-impedance board is used, it is best to observe the following guidelines when designing the board:

- 1) Do not use wire-wrapped boards (they are too inductive) or breadboards (they are too capacitive).
- 2) Do not use IC sockets; they increase parasitic capacitance and inductance.
- 3) Keep signal lines as short and straight as possible. Do not make 90° turns; round all corners.
- 4) Observe high-frequency bypassing techniques to maintain the amplifier's accuracy and stability.
- 5) Use surface-mount components. They generally have shorter bodies and lower parasitic reactance, yielding better high-frequency performance than through-hole components.

High-Speed, Low-Power, Single-Supply Multichannel, Video Multiplexer-Amplifiers

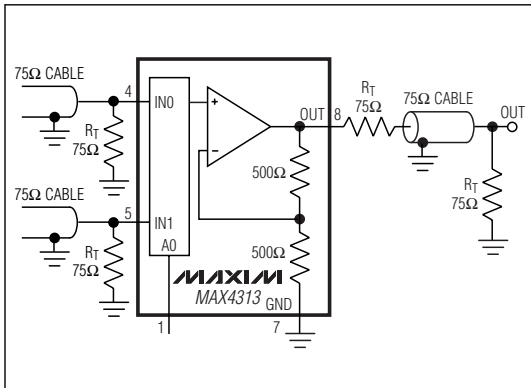

Figure 5. Video Line Driver

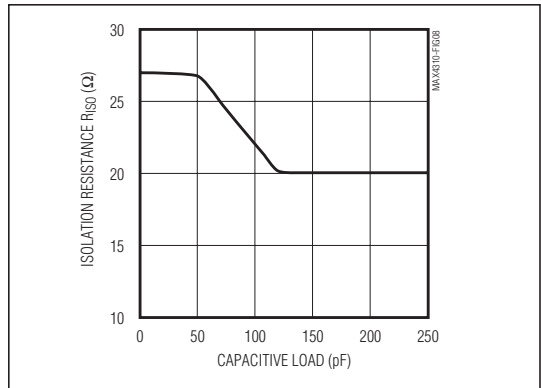

Figure 8. Optimal Isolation Resistance vs. Capacitive Load

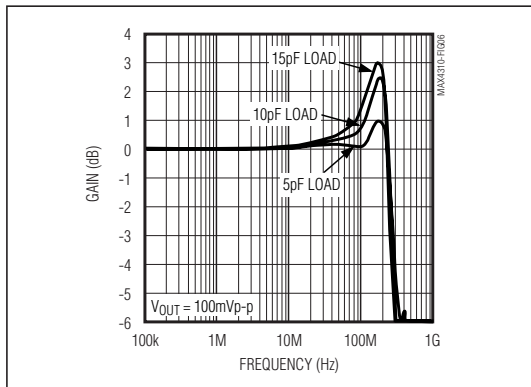

Figure 6. Small-Signal Gain vs. Frequency with a Capacitive Load and No-Isolation Resistor

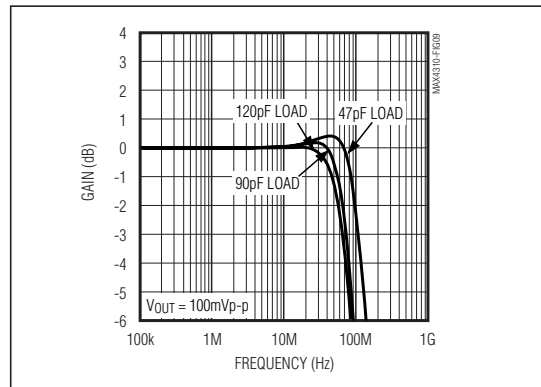

Figure 9. Small-Signal Gain vs. Frequency with a Capacitive Load and 27Ω No-Isolation Resistor

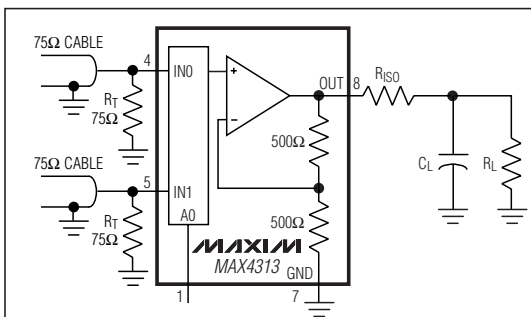

Figure 7. Using an Isolation Resistor (R_{ISO}) for High-Capacitive Loads

The bypass capacitors should include a 100nF, ceramic surface-mount capacitor between each supply pin and the ground plane, located as close to the package as possible. Optionally, place a 10μF tantalum capacitor at the power-supply pin's point of entry to the PC board to ensure the integrity of incoming supplies. The power-supply trace should lead directly from the tantalum capacitor to the VCC and VEE pins. To minimize parasitic inductance, keep PC traces short and use surface-mount components. If input termination resistors and output back-termination resistors are used, they should be surface-mount types, and should be placed as close to the IC pins as possible.

High-Speed, Low-Power, Single-Supply Multichannel, Video Multiplexer-Amplifiers

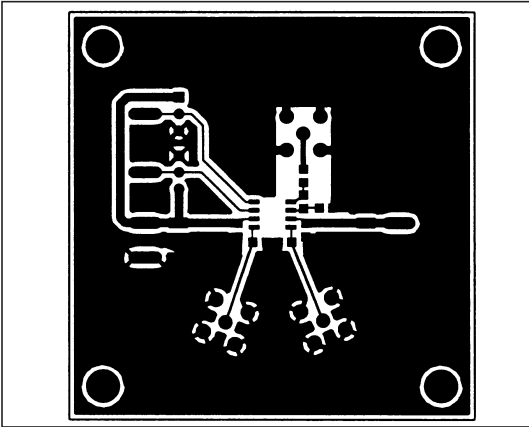

Figure 10. High-Speed EV Board Layout—Component Side

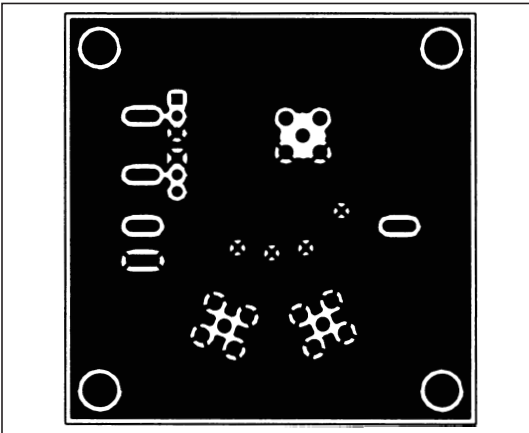

Figure 11. High-Speed EV Board Layout—Solder Side

Video Line Driver

The MAX4310-MAX4315 are well-suited to drive coaxial transmission lines when the cable is terminated at both ends, as shown in Figure 5. Cable frequency response can cause variations in the signal's flatness.

Driving Capacitive Loads

A correctly terminated transmission line is purely resistive and presents no capacitive load to the amplifier. Reactive loads decrease phase margin and may produce excessive ringing and oscillation (see *Typical Operating Characteristics*).

Table 2. Input Control Logic

| MAX4310/MAX4313 | | | | |
|-----------------|----|----|----|---------------------|
| SHDN | A2 | A1 | A0 | CHANNEL SELECTED |
| 0 | — | — | X | None, High-Z Output |
| 1 | — | — | 0 | 0 |
| 1 | — | — | 1 | 1 |
| MAX4311/MAX4314 | | | | |
| SHDN | A2 | A1 | A0 | CHANNEL SELECTED |
| 0 | — | X | X | None, High-Z Output |
| 1 | — | 0 | 0 | 0 |
| 1 | — | 0 | 1 | 1 |
| 1 | — | 1 | 0 | 2 |
| 1 | — | 1 | 1 | 3 |
| MAX4312/MAX4315 | | | | |
| SHDN | A2 | A1 | A0 | CHANNEL SELECTED |
| 0 | X | X | X | None, High-Z Output |
| 1 | 0 | 0 | 0 | 0 |
| 1 | 0 | 0 | 1 | 1 |
| 1 | 0 | 1 | 0 | 2 |
| 1 | 0 | 1 | 1 | 3 |
| 1 | 1 | 0 | 0 | 4 |
| 1 | 1 | 0 | 1 | 5 |
| 1 | 1 | 1 | 0 | 6 |
| 1 | 1 | 1 | 1 | 7 |

Another concern when driving capacitive loads originates from the amplifier's output impedance, which appears inductive at high frequencies. This inductance forms an L-C resonant circuit with the capacitive load, which causes peaking in the frequency response and degrades the amplifier's phase margin.

Although the MAX4310-MAX4315 are optimized for AC performance and are not designed to drive highly capacitive loads, they are capable of driving up to 20pF without oscillations. However, some peaking may occur in the frequency domain (Figure 6). To drive larger capacitive loads or to reduce ringing, add an isolation resistor between the amplifier's output and the load (Figure 7).

The value of RISO depends on the circuit's gain and the capacitive load (Figure 8). Figure 9 shows the MAX4310-MAX4315 frequency response with the isolation resistor and a capacitive load. With higher capacitive values, bandwidth is dominated by the RC network formed by RISO and CL; the bandwidth of the amplifier itself is much higher. Also note that the isolation resistor forms a divider that decreases the voltage delivered to the load.

High-Speed, Low-Power, Single-Supply Multichannel, Video Multiplexer-Amplifiers

Digital Interface

The multiplexer architecture of the MAX4310–MAX4315 ensures that no two input channels are ever connected together. Channel selection is accomplished by applying a binary code to channel address inputs. The address decoder selects input channels, as shown in Table 2. All digital inputs are CMOS compatible.

High-Speed Evaluation Board

Figures 10 and 11 show the evaluation board and present a suggested layout for the circuits. This board was developed using the techniques described in the *Layout and Power-Supply Bypassing* section. The smallest available surface-mount resistors were used

for feedback and back-termination to minimize their distance from the part, reducing the capacitance associated with longer lead lengths.

SMA connectors were used for best high-frequency performance. Inputs and outputs do not match a 75Ω line, but this does not affect performance since distances are extremely short. However, in applications that require lead lengths greater than one-quarter of the wavelength of the highest frequency of interest, use constant-impedance traces. Fully assembled evaluation boards are available for the MAX4313 in an SO package.

Typical Operating Circuit

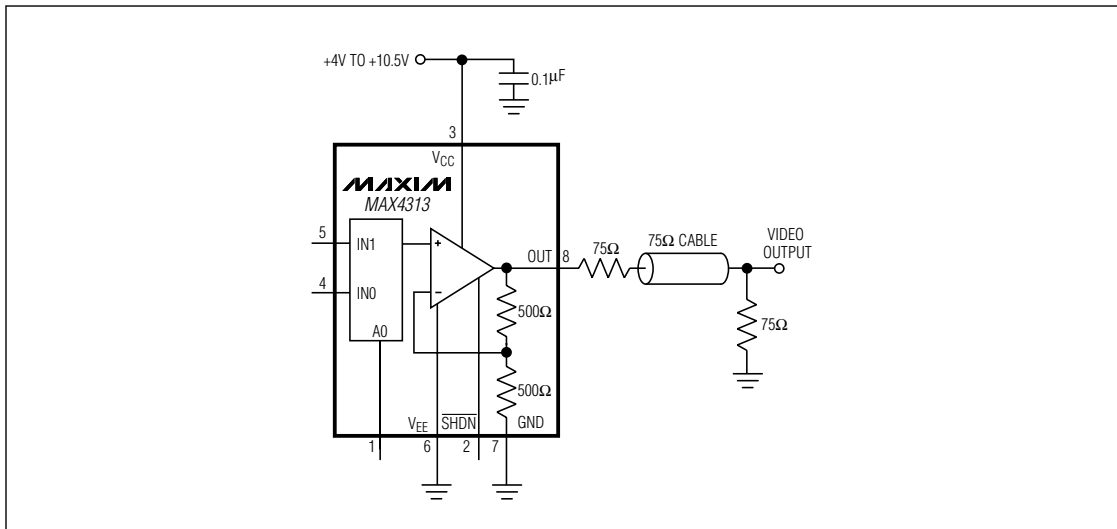

Chip Information

TRANSISTOR COUNT: 156

Package Information

For the latest package outline information, go to www.maxim-ic.com/packages.

| PACKAGE TYPE | PACKAGE CODE | DOCUMENT NO. |
|--------------|--------------|-------------------------|
| 8 SO | S8-4 | 21-0041 |
| 8 µMAX | U8-1 | 21-0036 |
| 14 Narrow SO | S14-1 | 21-0041 |
| 16 Narrow SO | S16-1 | 21-0041 |
| 16 QSOP | E16-1 | 21-0055 |

High-Speed, Low-Power, Single-Supply Multichannel, Video Multiplexer-Amplifiers

Pin Configurations

MAX4310-MAX4315

TOP VIEW

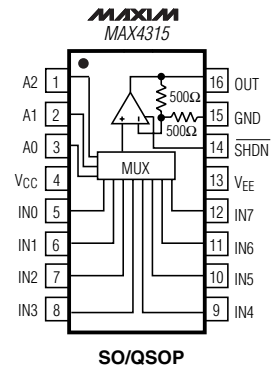
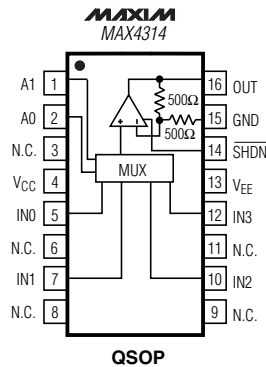
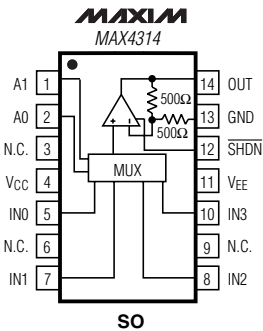
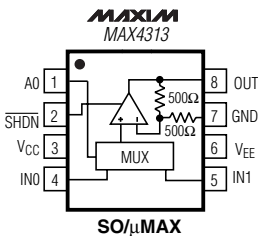
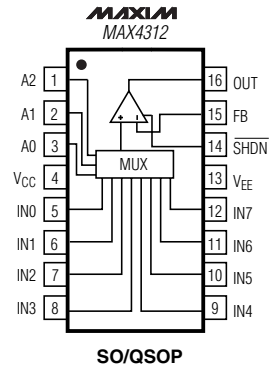
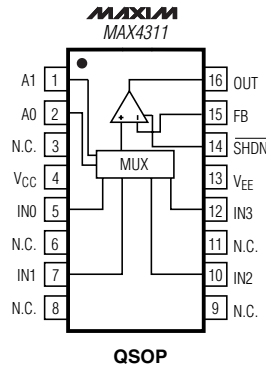
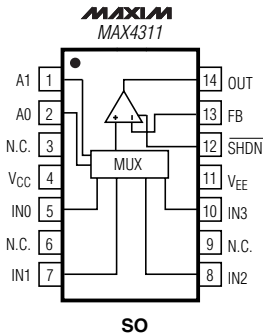
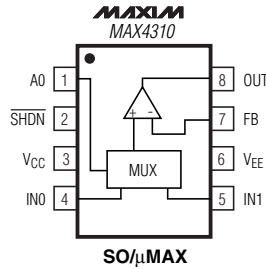

N.C. = NOT INTERNALLY CONNECTED. TIE TO GROUND PLANE FOR OPTIMAL PERFORMANCE.

High-Speed, Low-Power, Single-Supply Multichannel, Video Multiplexer-Amplifiers

Revision History

| REVISION NUMBER | REVISION DATE | DESCRIPTION | PAGES CHANGED |
|-----------------|---------------|--|---------------|
| 0 | 7/98 | Initial release | — |
| 1 | 4/99 | Added new parts to data sheet. | 1-20 |
| 2 | 12/02 | Corrected MAX4314 Pin Configuration. | 17 |
| 3 | 3/08 | Updated <i>Typical Operating Characteristics</i> . | 8 |

Maxim cannot assume responsibility for use of any circuitry other than circuitry entirely embodied in a Maxim product. No circuit patent licenses are implied. Maxim reserves the right to change the circuitry and specifications without notice at any time.

18 _____ **Maxim Integrated Products, 120 San Gabriel Drive, Sunnyvale, CA 94086 408-737-7600**



Компания «ЭлектроПласт» предлагает заключение долгосрочных отношений при поставках импортных электронных компонентов на взаимовыгодных условиях!

Наши преимущества:

- Оперативные поставки широкого спектра электронных компонентов отечественного и импортного производства напрямую от производителей и с крупнейших мировых складов;
- Поставка более 17-ти миллионов наименований электронных компонентов;
- Поставка сложных, дефицитных, либо снятых с производства позиций;
- Оперативные сроки поставки под заказ (от 5 рабочих дней);
- Экспресс доставка в любую точку России;
- Техническая поддержка проекта, помощь в подборе аналогов, поставка прототипов;
- Система менеджмента качества сертифицирована по Международному стандарту ISO 9001;
- Лицензия ФСБ на осуществление работ с использованием сведений, составляющих государственную тайну;
- Поставка специализированных компонентов (Xilinx, Altera, Analog Devices, Intersil, Interpoint, Microsemi, Aeroflex, Peregrine, Syfer, Eurofarad, Texas Instrument, Miteq, Cobham, E2V, MA-COM, Hittite, Mini-Circuits, General Dynamics и др.);

Помимо этого, одним из направлений компании «ЭлектроПласт» является направление «Источники питания». Мы предлагаем Вам помощь Конструкторского отдела:

- Подбор оптимального решения, техническое обоснование при выборе компонента;
- Подбор аналогов;
- Консультации по применению компонента;
- Поставка образцов и прототипов;
- Техническая поддержка проекта;
- Защита от снятия компонента с производства.



Как с нами связаться

Телефон: 8 (812) 309 58 32 (многоканальный)

Факс: 8 (812) 320-02-42

Электронная почта: org@eplast1.ru

Адрес: 198099, г. Санкт-Петербург, ул. Калинина, дом 2, корпус 4, литера А.