

ISL21010

Micropower Voltage Reference

FN7896
Rev 6.00
Apr 19, 2019

The **ISL21010** is a precision, low dropout micropower bandgap voltage reference in a space-saving SOT-23 package. It operates from a single 2.2V to 5.5V supply (minimum voltage is dependent on voltage option) and provides a $\pm 0.2\%$ accurate reference. The ISL21010 provides up to 25mA output current sourcing with low 150mV dropout voltage.

Output voltage options include 1.024V, 1.2V, 1.5V, 2.048V, 2.5V, 3.0V, 3.3V, and 4.096V. The low supply current and low dropout voltage combined with high accuracy make the ISL21010 ideal for precision battery powered applications.

Applications

- Battery management/monitoring
- Low power standby voltages
- Portable instrumentation
- Consumer/medical electronics
- Lower cost industrial and instrumentation
- Power regulation circuits
- Control loops and compensation networks
- LED/diode supply

Features

- Reference output voltages 1.024V, 1.25V, 1.5V, 2.048V, 2.5V, 3.0V, 3.3V, 4.096V
- Precision 0.2% initial accuracy
- Input voltage range:
 - ISL21010-10, -12, -15 -20 2.2V to 5.5V
 - ISL21010-25 2.6V to 5.5V
 - ISL21010-30 3.1V to 5.5V
 - ISL21010-33 3.4V to 5.5V
 - ISL21010-41 4.2V to 5.5V
- Output current source capability 25mA
- Operating temperature range -40°C to +125°C
- Output voltage noise ($V_{OUT} = 2.048V$) 58 μ V_{P-P} (0.1Hz to 10Hz)
- Supply current 48 μ A (typical)
- Tempco 50ppm/°C
- Package 3 Ld SOT-23
- Pb-free (RoHS compliant)

Related Literature

For a full list of related documents, visit our website:

- [ISL21010DFH310](#), [ISL21010DFH312](#), [ISL21010CFH315](#), [ISL21010CFH320](#), [ISL21010CFH325](#), [ISL21010CFH330](#), [ISL21010CFH333](#), and [ISL21010CFH341](#) device pages



FIGURE 1. TYPICAL APPLICATION DIAGRAM

Table of Contents

| | |
|---|-----------|
| Typical Application Circuit | 3 |
| Pin Configuration | 3 |
| Pin Descriptions | 3 |
| Ordering Information | 4 |
| Absolute Maximum Ratings | 5 |
| Thermal Information | 5 |
| Recommended Operating Conditions | 5 |
| Electrical Specifications (ISL21010-10, $V_{OUT} = 1.024V$) | 5 |
| Electrical Specifications (ISL21010-12, $V_{OUT} = 1.25V$) | 6 |
| Electrical Specifications (ISL21010-15, $V_{OUT} = 1.5V$) | 6 |
| Electrical Specifications (ISL21010-20, $V_{OUT} = 2.048V$) | 7 |
| Electrical Specifications (ISL21010-25, $V_{OUT} = 2.5V$) | 7 |
| Electrical Specifications (ISL21010-30, $V_{OUT} = 3.0V$) | 8 |
| Electrical Specifications (ISL21010-33, $V_{OUT} = 3.3V$) | 8 |
| Electrical Specifications (ISL21010-41, $V_{OUT} = 4.096V$) | 9 |
| Typical Performance Characteristics Curves ($V_{OUT} = 1.024V$) | 10 |
| Typical Performance Characteristics Curves ($V_{OUT} = 1.25V$) | 13 |
| Typical Performance Characteristics Curves ($V_{OUT} = 1.5V$) | 16 |
| Typical Performance Characteristics Curves ($V_{OUT} = 2.048V$) | 19 |
| Typical Performance Characteristics Curves ($V_{OUT} = 2.5V$) | 22 |
| Typical Performance Characteristics Curves ($V_{OUT} = 3.0V$) | 25 |
| Typical Performance Characteristics Curves ($V_{OUT} = 3.3V$) | 28 |
| Typical Performance Characteristics Curves ($V_{OUT} = 4.096V$) | 31 |
| Applications Information | 34 |
| Micropower Operation | 34 |
| Board Mounting Considerations | 34 |
| Board Assembly Considerations | 34 |
| Noise Performance and Reduction | 34 |
| Cycling V_{IN} On-Off-On (CAUTION) | 34 |
| Revision History | 35 |
| Package Outline Drawing | 36 |

Typical Application Circuit



FIGURE 2. KELVIN SENSED LOAD

Pin Configuration



Pin Descriptions

| PIN NUMBER | PIN NAME | DESCRIPTION |
|------------|----------|--------------------------|
| 1 | VIN | Input voltage connection |
| 2 | VOUT | Voltage reference output |
| 3 | GND | Ground connection |

Ordering Information

| PART NUMBER (Notes 2, 3, 4) | PART MARKING | TAPE & REEL QUANTITY (UNITS) (Note 1) | V _{OUT} OPTION (V) | INITIAL ACCURACY (%) | TEMP. RANGE (°C) | PACKAGE (RoHS Compliant) | PKG. DWG. # |
|--------------------------------|----------------------------------|---|-----------------------------|-------------------------|------------------|-----------------------------|----------------|
| ISL21010DFH310Z-T | BEBA | 3k | 1.024 | ±0.2 | -40 to +125 | 3 Ld SOT-23 | P3.064 |
| ISL21010DFH310Z-TK | BEBA | 1k | 1.024 | ±0.2 | -40 to +125 | 3 Ld SOT-23 | P3.064 |
| ISL21010DFH310Z-T7A | BEBA | 250 | 1.024 | ±0.2 | -40 to +125 | 3 Ld SOT-23 | P3.064 |
| ISL21010DFH312Z-T | BECA | 3k | 1.25 | ±0.2 | -40 to +125 | 3 Ld SOT-23 | P3.064 |
| ISL21010DFH312Z-TK | BECA | 1k | 1.25 | ±0.2 | -40 to +125 | 3 Ld SOT-23 | P3.064 |
| ISL21010DFH312Z-T7A | BECA | 250 | 1.25 | ±0.2 | -40 to +125 | 3 Ld SOT-23 | P3.064 |
| ISL21010CFH315Z-TK | BDRA | 1k | 1.5 | ±0.2 | -40 to +125 | 3 Ld SOT-23 | P3.064 |
| ISL21010CFH315Z-T7A | BDRA | 250 | 1.5 | ±0.2 | -40 to +125 | 3 Ld SOT-23 | P3.064 |
| ISL21010CFH320Z-TK | BDSA | 1k | 2.048 | ±0.2 | -40 to +125 | 3 Ld SOT-23 | P3.064 |
| ISL21010CFH320Z-T7A | BDSA | 250 | 2.048 | ±0.2 | -40 to +125 | 3 Ld SOT-23 | P3.064 |
| ISL21010CFH325Z-TK | BDTA | 1k | 2.5 | ±0.2 | -40 to +125 | 3 Ld SOT-23 | P3.064 |
| ISL21010CFH325Z-T7A | BDTA | 250 | 2.5 | ±0.2 | -40 to +125 | 3 Ld SOT-23 | P3.064 |
| ISL21010CFH330Z-TK | BDVA | 1k | 3.0 | ±0.2 | -40 to +125 | 3 Ld SOT-23 | P3.064 |
| ISL21010CFH330Z-T7A | BDVA | 250 | 3.0 | ±0.2 | -40 to +125 | 3 Ld SOT-23 | P3.064 |
| ISL21010CFH333Z-TK | BDWA | 1k | 3.3 | ±0.2 | -40 to +125 | 3 Ld SOT-23 | P3.064 |
| ISL21010CFH333Z-T7A | BDWA | 250 | 3.3 | ±0.2 | -40 to +125 | 3 Ld SOT-23 | P3.064 |
| ISL21010CFH341Z-TK | BDYA | 1k | 4.096 | ±0.2 | -40 to +125 | 3 Ld SOT-23 | P3.064 |
| ISL21010CFH341Z-T7A | BDYA | 250 | 4.096 | ±0.2 | -40 to +125 | 3 Ld SOT-23 | P3.064 |
| ISL2101010EV1Z | ISL21010DFH310Z Evaluation Board | | | | | | |
| ISL2101012EV1Z | ISL21010DFH312Z Evaluation Board | | | | | | |
| ISL2101015EV1Z | ISL21010CFH315Z Evaluation Board | | | | | | |

NOTES:

- See [TB347](#) for details about reel specifications.
- These Pb-free plastic packaged products employ special Pb-free material sets, molding compounds/die attach materials, and 100% matte tin plate plus anneal (e3 termination finish, which is RoHS compliant and compatible with both SnPb and Pb-free soldering operations). Pb-free products are MSL classified at Pb-free peak reflow temperatures that meet or exceed the Pb-free requirements of IPC/JEDEC J STD-020.
- For Moisture Sensitivity Level (MSL), see the [ISL21010DFH310](#), [ISL21010DFH312](#), [ISL21010CFH315](#), [ISL21010CFH320](#), [ISL21010CFH325](#), [ISL21010CFH330](#), [ISL21010CFH333](#), [ISL21010CFH341](#) device pages. For more information about MSL, see [TB363](#).
- The part marking is located on the bottom of the part.

Absolute Maximum Ratings

| | |
|--------------------------------|--------------------------|
| Max Voltage | |
| V_{IN} to GND | -0.5V to +6.5V |
| V_{OUT} (pin) to GND (10s) | -0.5V to $V_{IN} + 0.5V$ |
| Input Voltage Slew Rate (Max) | 1V/ μ s |
| Temperature Range (Industrial) | -40°C to +125°C |
| ESD Rating | |
| Human Body Model | 5.5kV |
| Machine Model | 300V |
| Charged Device Model | 2kV |

Thermal Information

| | | |
|---|---------------------------|----------------------|
| Thermal Resistance (Typical) | θ_{JA} (°C/W) | θ_{JC} (°C/W) |
| 3 Ld SOT-23 Package (Notes 5, 6) | 275 | 110 |
| Continuous Power Dissipation ($T_A = +125^\circ\text{C}$) | 99mW | |
| Storage Temperature Range | -65°C to +150°C | |
| Pb-Free Reflow Profile | see TB493 | |

Recommended Operating Conditions

| | |
|---|-----------------|
| Temperature | -40°C to +125°C |
| Supply Voltage | |
| $V_{OUT} = 1.024V, 1.25V, 1.5V, 2.048V$ | 2.2V to 5.5V |
| $V_{OUT} = 2.5V$ | 2.6V to 5.5V |
| $V_{OUT} = 3.0V$ | 3.1V to 5.5V |
| $V_{OUT} = 3.3V$ | 3.4V to 5.5V |
| $V_{OUT} = 4.096V$ | 4.2V to 5.5V |

CAUTION: Do not operate at or near the maximum ratings listed for extended periods of time. Exposure to such conditions can adversely impact product reliability and result in failures not covered by warranty.

NOTES:

- θ_{JA} is measured with the component mounted on a high-effective thermal conductivity test board in free air. See [TB379](#) for details.
- For θ_{JC} , the "case temp" location is taken at the package top center.

Electrical Specifications (ISL21010-10, $V_{OUT} = 1.024V$) $V_{IN} = 3.0V, T_A = +25^\circ\text{C}, I_{OUT} = 0A$, unless otherwise specified. **Boldface limits apply across the operating temperature range, -40°C to +125°C.**

| PARAMETER | SYMBOL | TEST CONDITIONS | MIN (Note 7) | TYP | MAX (Note 7) | UNIT |
|---|-----------------------------------|---|-----------------|-------|-----------------|------------------------|
| Output Voltage | V_{OUT} | | | 1.024 | | V |
| V_{OUT} Accuracy at $T_A = +25^\circ\text{C}$ (Note 11) | V_{OA} | | -0.2 | | +0.2 | % |
| Output Voltage Temperature Coefficient (Note 8) | TC V_{OUT} | | | 15 | 50 | ppm/°C |
| Input Voltage Range | V_{IN} | | 2.2 | | 5.5 | V |
| Supply Current | I_{IN} | $T_A = +25^\circ\text{C}$ | | 46 | 80 | μ A |
| | | $T_A = -40^\circ\text{C}$ to $+125^\circ\text{C}$ | | 60 | 100 | μ A |
| Line Regulation | $\Delta V_{OUT} / \Delta V_{IN}$ | $2.2V \leq V_{IN} \leq 5.5V$ | | 5 | 100 | μ V/V |
| Load Regulation | $\Delta V_{OUT} / \Delta I_{OUT}$ | Sourcing: $0mA \leq I_{OUT} \leq 25mA$ | | 15 | 110 | μ V/mA |
| | | Sinking: $-1mA \leq I_{OUT} \leq 0mA$ | | 17 | | μ V/mA |
| Short-Circuit Current | I_{SC} | $T_A = +25^\circ\text{C}, V_{OUT}$ tied to GND | | 118 | | mA |
| Turn-On Settling Time | t_R | $V_{OUT} = \pm 0.1\%, C_{OUT} = 1\mu F$ | | 300 | | μ s |
| Ripple Rejection | | $f = 120\text{Hz}$ | | 70 | | dB |
| Output Voltage Noise | e_N | $0.1\text{Hz} \leq f \leq 10\text{Hz}$ | | 24 | | μ V _{p-p} |
| Broadband Voltage Noise | V_N | $10\text{Hz} \leq f \leq 1\text{kHz}$ | | 14 | | μ V _{RMS} |
| Thermal Hysteresis (Note 10) | $\Delta V_{OUT} / \Delta T_A$ | $\Delta T_A = +165^\circ\text{C}$ | | 100 | | ppm |
| Long Term Stability | $\Delta V_{OUT} / \Delta t$ | 1000 hours, $T_A = +25^\circ\text{C}$ | | 110 | | ppm |

Electrical Specifications (ISL21010-12, $V_{OUT} = 1.25V$) $V_{IN} = 3.0V$, $T_A = +25^\circ C$, $I_{OUT} = 0A$, unless otherwise specified.
Boldface limits apply across the operating temperature range, $-40^\circ C$ to $+125^\circ C$.

| PARAMETER | SYMBOL | TEST CONDITIONS | MIN (Note 7) | TYP | MAX (Note 7) | UNIT |
|---|---------------------------------|---|-----------------|------|-----------------|-----------------|
| Output Voltage | V_{OUT} | | | 1.25 | | V |
| V_{OUT} Accuracy at $T_A = +25^\circ C$ (Note 11) | V_{OA} | | -0.2 | | +0.2 | % |
| Output Voltage Temperature Coefficient (Note 8) | TC V_{OUT} | | | 15 | 50 | ppm/ $^\circ C$ |
| Input Voltage Range | V_{IN} | | 2.2 | | 5.5 | V |
| Supply Current | I_{IN} | $T_A = +25^\circ C$ | | 46 | 80 | μA |
| | | $T_A = -40^\circ C$ to $+125^\circ C$ | | | 100 | μA |
| Line Regulation | $\Delta V_{OUT}/\Delta V_{IN}$ | $2.2V \leq V_{IN} \leq 5.5V$ | | 1 | 100 | $\mu V/V$ |
| Load Regulation | $\Delta V_{OUT}/\Delta I_{OUT}$ | Sourcing: $0mA \leq I_{OUT} \leq 25mA$ | | 35 | 110 | $\mu V/mA$ |
| | | Sinking: $-1mA \leq I_{OUT} \leq 0mA$ | | 50 | | $\mu V/mA$ |
| Short-Circuit Current | I_{SC} | $T_A = +25^\circ C$, V_{OUT} tied to GND | | 118 | | mA |
| Turn-On Settling Time | t_R | $V_{OUT} = \pm 0.1\%$, $C_{OUT} = 1\mu F$ | | 300 | | μs |
| Ripple Rejection | | $f = 120Hz$ | | 68 | | dB |
| Output Voltage Noise | e_N | $0.1Hz \leq f \leq 10Hz$ | | 27 | | μV_{P-P} |
| Broadband Voltage Noise | V_N | $10Hz \leq f \leq 1kHz$ | | 17 | | μV_{RMS} |
| Thermal Hysteresis (Note 10) | $\Delta V_{OUT}/\Delta T_A$ | $\Delta T_A = +165^\circ C$ | | 100 | | ppm |
| Long Term Stability | $\Delta V_{OUT}/\Delta t$ | 1000 hours, $T_A = +25^\circ C$ | | 110 | | ppm |

Electrical Specifications (ISL21010-15, $V_{OUT} = 1.5V$) $V_{IN} = 3.0V$, $T_A = +25^\circ C$, $I_{OUT} = 0A$, unless otherwise specified.
Boldface limits apply across the operating temperature range, $-40^\circ C$ to $+125^\circ C$.

| PARAMETER | SYMBOL | TEST CONDITIONS | MIN (Note 7) | TYP | MAX (Note 7) | UNIT |
|---|---------------------------------|---|-----------------|-----|-----------------|-----------------|
| Output Voltage | V_{OUT} | | | 1.5 | | V |
| V_{OUT} Accuracy at $T_A = +25^\circ C$ (Note 11) | V_{OA} | | -0.2 | | +0.2 | % |
| Output Voltage Temperature Coefficient (Note 8) | TC V_{OUT} | | | 15 | 50 | ppm/ $^\circ C$ |
| Input Voltage Range | V_{IN} | | 2.2 | | 5.5 | V |
| Supply Current | I_{IN} | $T_A = +25^\circ C$ | | 46 | 80 | μA |
| | | $T_A = -40^\circ C$ to $+125^\circ C$ | | | 100 | μA |
| Line Regulation | $\Delta V_{OUT}/\Delta V_{IN}$ | $2.2V \leq V_{IN} \leq 5.5V$ | | 9 | 100 | $\mu V/V$ |
| Load Regulation | $\Delta V_{OUT}/\Delta I_{OUT}$ | Sourcing: $0mA \leq I_{OUT} \leq 25mA$ | | 37 | 110 | $\mu V/mA$ |
| | | Sinking: $-1mA \leq I_{OUT} \leq 0mA$ | | 50 | | $\mu V/mA$ |
| Short-Circuit Current | I_{SC} | $T_A = +25^\circ C$, V_{OUT} tied to GND | | 118 | | mA |
| Turn-On Settling Time | t_R | $V_{OUT} = \pm 0.1\%$, $C_{OUT} = 1\mu F$ | | 300 | | μs |
| Ripple Rejection | | $f = 120Hz$ | | 66 | | dB |
| Output Voltage Noise | e_N | $0.1Hz \leq f \leq 10Hz$ | | 35 | | μV_{P-P} |
| Broadband Voltage Noise | V_N | $10Hz \leq f \leq 1kHz$ | | 20 | | μV_{RMS} |
| Thermal Hysteresis (Note 10) | $\Delta V_{OUT}/\Delta T_A$ | $\Delta T_A = +165^\circ C$ | | 100 | | ppm |
| Long Term Stability | $\Delta V_{OUT}/\Delta t$ | 1000 hours, $T_A = +25^\circ C$ | | 110 | | ppm |

Electrical Specifications (ISL21010-20, $V_{OUT} = 2.048V$) $V_{IN} = 3.0V$, $T_A = +25^\circ C$, $I_{OUT} = 0A$, unless otherwise specified. **Boldface limits apply across the operating temperature range, $-40^\circ C$ to $+125^\circ C$.**

| PARAMETER | SYMBOL | TEST CONDITIONS | MIN (Note 7) | TYP | MAX (Note 7) | UNIT |
|---|---------------------------------|---|-----------------|-------|-----------------|-----------------|
| Output Voltage | V_{OUT} | | | 2.048 | | V |
| V_{OUT} Accuracy at $T_A = +25^\circ C$ (Note 11) | V_{OA} | | -0.2 | | +0.2 | % |
| Output Voltage Temperature Coefficient (Note 8) | TC V_{OUT} | | | 15 | 50 | ppm/ $^\circ C$ |
| Input Voltage Range | V_{IN} | | 2.2 | | 5.5 | V |
| Supply Current | I_{IN} | $T_A = +25^\circ C$ | | 46 | 80 | μA |
| | | $T_A = -40^\circ C$ to $+125^\circ C$ | | | 100 | μA |
| Line Regulation | $\Delta V_{OUT}/\Delta V_{IN}$ | $2.2V \leq V_{IN} \leq 5.5V$ | | 37 | 130 | $\mu V/V$ |
| Load Regulation | $\Delta V_{OUT}/\Delta I_{OUT}$ | Sourcing: $0mA \leq I_{OUT} \leq 25mA$ | | 18 | 110 | $\mu V/mA$ |
| | | Sinking: $-1mA \leq I_{OUT} \leq 0mA$ | | 10 | | $\mu V/mA$ |
| Short-Circuit Current | I_{SC} | $T_A = +25^\circ C$, V_{OUT} tied to GND | | 118 | | mA |
| Turn-On Settling Time | t_R | $V_{OUT} = \pm 0.1\%$, $C_{OUT} = 1\mu F$ | | 300 | | μs |
| Ripple Rejection | | $f = 120Hz$ | | 66 | | dB |
| Output Voltage Noise | e_N | $0.1Hz \leq f \leq 10Hz$ | | 58 | | μV_{P-P} |
| Broadband Voltage Noise | V_N | $10Hz \leq f \leq 1kHz$ | | 26 | | μV_{RMS} |
| Thermal Hysteresis (Note 10) | $\Delta V_{OUT}/\Delta T_A$ | $\Delta T_A = +165^\circ C$ | | 100 | | ppm |
| Long Term Stability | $\Delta V_{OUT}/\Delta t$ | 1000 hours, $T_A = +25^\circ C$ | | 50 | | ppm |

Electrical Specifications (ISL21010-25, $V_{OUT} = 2.5V$) $V_{IN} = 3.0V$, $T_A = +25^\circ C$, $I_{OUT} = 0A$, unless otherwise specified. **Boldface limits apply across the operating temperature range, $-40^\circ C$ to $+125^\circ C$.**

| PARAMETER | SYMBOL | TEST CONDITIONS | MIN (Note 7) | TYP | MAX (Note 7) | UNIT |
|---|---------------------------------|---|-----------------|-----|-----------------|-----------------|
| Output Voltage | V_{OUT} | | | 2.5 | | V |
| V_{OUT} Accuracy at $T_A = +25^\circ C$ (Note 11) | V_{OA} | | -0.2 | | +0.2 | % |
| Output Voltage Temperature Coefficient (Note 8) | TC V_{OUT} | | | 15 | 50 | ppm/ $^\circ C$ |
| Input Voltage Range | V_{IN} | | 2.6 | | 5.5 | V |
| Supply Current | I_{IN} | $T_A = +25^\circ C$ | | 46 | 80 | μA |
| | | $T_A = -40^\circ C$ to $+125^\circ C$ | | | 100 | μA |
| Line Regulation | $\Delta V_{OUT}/\Delta V_{IN}$ | $2.6V \leq V_{IN} \leq 5.5V$ | | 62 | 245 | $\mu V/V$ |
| Load Regulation | $\Delta V_{OUT}/\Delta I_{OUT}$ | Sourcing: $0mA \leq I_{OUT} \leq 25mA$ | | 29 | 110 | $\mu V/mA$ |
| | | Sinking: $-1mA \leq I_{OUT} \leq 0mA$ | | 50 | | $\mu V/mA$ |
| Dropout Voltage (Note 9) | V_{INDO} | $I_{OUT} = 10mA$ | | 60 | 150 | mV |
| Short-Circuit Current | I_{SC} | $T_A = +25^\circ C$, V_{OUT} tied to GND | | 118 | | mA |
| Turn-On Settling Time | t_R | $V_{OUT} = \pm 0.1\%$, $C_{OUT} = 1\mu F$ | | 300 | | μs |
| Ripple Rejection | | $f = 120Hz$ | | 62 | | dB |
| Output Voltage Noise | e_N | $0.1Hz \leq f \leq 10Hz$ | | 67 | | μV_{P-P} |
| Broadband Voltage Noise | V_N | $10Hz \leq f \leq 1kHz$ | | 37 | | μV_{RMS} |
| Thermal Hysteresis (Note 10) | $\Delta V_{OUT}/\Delta T_A$ | $\Delta T_A = +165^\circ C$ | | 100 | | ppm |
| Long Term Stability | $\Delta V_{OUT}/\Delta t$ | 1000 hours, $T_A = +25^\circ C$ | | 110 | | ppm |

Electrical Specifications (ISL21010-30, V_{OUT} = 3.0V) V_{IN} = 5.0V, T_A = +25°C, I_{OUT} = 0A, unless otherwise specified.
Boldface limits apply across the operating temperature range, -40°C to +125°C.

| PARAMETER | SYMBOL | TEST CONDITIONS | MIN (Note 7) | TYP | MAX (Note 7) | UNIT |
|---|--------------------------------------|--|-----------------|-----|-----------------|-------------------|
| Output Voltage | V _{OUT} | | | 3.0 | | V |
| V _{OUT} Accuracy at T _A = +25°C (Note 11) | V _{OA} | | -0.2 | | +0.2 | % |
| Output Voltage Temperature Coefficient (Note 8) | TC V _{OUT} | | | 15 | 50 | ppm/°C |
| Input Voltage Range | V _{IN} | | 3.1 | | 5.5 | V |
| Supply Current | I _{IN} | T _A = +25°C | | 48 | 80 | μA |
| | | T _A = -40°C to +125°C | | | 100 | μA |
| Line Regulation | ΔV _{OUT} /ΔV _{IN} | 3.1 V ≤ V _{IN} ≤ 5.5V | | 73 | 230 | μV/V |
| Load Regulation | ΔV _{OUT} /ΔI _{OUT} | Sourcing: 0mA ≤ I _{OUT} ≤ 25mA | | 48 | 110 | μV/mA |
| | | Sinking: -1mA ≤ I _{OUT} ≤ 0mA | | 10 | | μV/mA |
| Dropout Voltage (Note 9) | V _{INDO} | I _{OUT} = 10mA | | 60 | 150 | mV |
| Short-Circuit Current | I _{SC} | T _A = +25°C, V _{OUT} tied to GND | | 126 | | mA |
| Turn-On Settling Time | t _R | V _{OUT} = ±0.1%, C _{OUT} = 1μF | | 300 | | μs |
| Ripple Rejection | | f = 120Hz | | 62 | | dB |
| Output Voltage Noise | e _N | 0.1Hz ≤ f ≤ 10Hz | | 86 | | μV _{p-p} |
| Broadband Voltage Noise | V _N | 10Hz ≤ f ≤ 1kHz | | 36 | | μV _{RMS} |
| Thermal Hysteresis (Note 10) | ΔV _{OUT} /ΔT _A | ΔT _A = +165°C | | 100 | | ppm |
| Long Term Stability | ΔV _{OUT} /Δt | 1000 hours, T _A = +25°C | | 50 | | ppm |

Electrical Specifications (ISL21010-33, V_{OUT} = 3.3V) V_{IN} = 5.0V, T_A = +25°C, I_{OUT} = 0A, unless otherwise specified.
Boldface limits apply across the operating temperature range, -40°C to +125°C.

| PARAMETER | SYMBOL | TEST CONDITIONS | MIN (Note 7) | TYP | MAX (Note 7) | UNIT |
|---|--------------------------------------|--|-----------------|-----|-----------------|-------------------|
| Output Voltage | V _{OUT} | | | 3.3 | | V |
| V _{OUT} Accuracy at T _A = +25°C (Note 11) | V _{OA} | | -0.2 | | +0.2 | % |
| Output Voltage Temperature Coefficient (Note 8) | TC V _{OUT} | | | 15 | 50 | ppm/°C |
| Input Voltage Range | V _{IN} | | 3.4 | | 5.5 | V |
| Supply Current | I _{IN} | T _A = +25°C | | 48 | 80 | μA |
| | | T _A = -40°C to +125°C | | | 100 | μA |
| Line Regulation | ΔV _{OUT} /ΔV _{IN} | 3.4 V ≤ V _{IN} ≤ 5.5V | | 80 | 320 | μV/V |
| Load Regulation | ΔV _{OUT} /ΔI _{OUT} | Sourcing: 0mA ≤ I _{OUT} ≤ 25mA | | 45 | 110 | μV/mA |
| | | Sinking: -1mA ≤ I _{OUT} ≤ 0mA | | 10 | | μV/mA |
| Dropout Voltage (Note 9) | V _{INDO} | I _{OUT} = 10mA | | 60 | 150 | mV |
| Short-Circuit Current | I _{SC} | T _A = +25°C, V _{OUT} tied to GND | | 126 | | mA |
| Turn-On Settling Time | t _R | V _{OUT} = ±0.1%, C _{OUT} = 1μF | | 300 | | μs |
| Ripple Rejection | | f = 120Hz | | 61 | | dB |
| Output Voltage Noise | e _N | 0.1Hz ≤ f ≤ 10Hz | | 95 | | μV _{p-p} |
| Broadband Voltage Noise | V _N | 10Hz ≤ f ≤ 1kHz | | 40 | | μV _{RMS} |
| Thermal Hysteresis (Note 10) | ΔV _{OUT} /ΔT _A | ΔT _A = +165°C | | 100 | | ppm |
| Long Term Stability | ΔV _{OUT} /Δt | 1000 hours, T _A = +25°C | | 50 | | ppm |

Electrical Specifications (ISL21010-41, $V_{OUT} = 4.096V$) $V_{IN} = 5.0V$, $T_A = +25^\circ C$, $I_{OUT} = 0A$, unless otherwise specified. **Boldface limits apply across the operating temperature range, $-40^\circ C$ to $+125^\circ C$.**

| PARAMETER | SYMBOL | TEST CONDITIONS | MIN (Note 7) | TYP | MAX (Note 7) | UNIT |
|---|-----------------------------------|---|-----------------|-------|-----------------|-----------------|
| Output Voltage | V_{OUT} | | | 4.096 | | V |
| V_{OUT} Accuracy at $T_A = +25^\circ C$ (Note 11) | V_{OA} | | -0.2 | | +0.2 | % |
| Output Voltage Temperature Coefficient (Note 8) | TC V_{OUT} | | | 15 | 50 | ppm/ $^\circ C$ |
| Input Voltage Range | V_{IN} | | 4.2 | | 5.5 | V |
| Supply Current | I_{IN} | $T_A = +25^\circ C$ | | 48 | 80 | μA |
| | | $T_A = -40^\circ C$ to $+125^\circ C$ | | | 100 | μA |
| Line Regulation | $\Delta V_{OUT} / \Delta V_{IN}$ | $4.2 V \leq V_{IN} \leq 5.5V$ | | 106 | 550 | $\mu V/V$ |
| Load Regulation | $\Delta V_{OUT} / \Delta I_{OUT}$ | Sourcing: $0mA \leq I_{OUT} \leq 25mA$ | | 50 | 140 | $\mu V/mA$ |
| | | Sinking: $-1mA \leq I_{OUT} \leq 0mA$ | | 50 | | $\mu V/mA$ |
| Dropout Voltage (Note 9) | V_{INDO} | $I_{OUT} = 10mA$ | | 60 | 150 | mV |
| Short-Circuit Current | I_{SC} | $T_A = +25^\circ C$, V_{OUT} tied to GND | | 126 | | mA |
| Turn-On Settling Time | t_R | $V_{OUT} = \pm 0.1\%$, $C_{OUT} = 1\mu F$ | | 300 | | μs |
| Ripple Rejection | | $f = 120Hz$ | | 58 | | dB |
| Output Voltage Noise | e_N | $0.1Hz \leq f \leq 10Hz$ | | 112 | | μV_{P-P} |
| Broadband Voltage Noise | V_N | $10Hz \leq f \leq 1kHz$ | | 56 | | μV_{RMS} |
| Thermal Hysteresis (Note 10) | $\Delta V_{OUT} / \Delta T_A$ | $\Delta T_A = +165^\circ C$ | | 100 | | ppm |
| Long Term Stability | $\Delta V_{OUT} / \Delta t$ | 1000 hours, $T_A = +25^\circ C$ | | 110 | | ppm |

NOTES:

- Compliance to datasheet limits is assured by one or more methods: production test, characterization, and/or design.
- Over the specified temperature range. Temperature coefficient is measured by the box method whereby the change in V_{OUT} is divided by the temperature range; in this case, $-40^\circ C$ to $+125^\circ C = +165^\circ C$.
- Dropout Voltage is the minimum $V_{IN} - V_{OUT}$ differential voltage measured at the point where V_{OUT} drops 1mV from $V_{IN} =$ nominal at $T_A = +25^\circ C$.
- Thermal Hysteresis is the change of V_{OUT} measured at $T_A = +25^\circ C$ after temperature cycling over a specified range, ΔT_A . V_{OUT} is read initially at $T_A = +25^\circ C$ for the device under test. The device is temperature cycled and a second V_{OUT} measurement is taken at $+25^\circ C$. The difference between the initial V_{OUT} reading and the second V_{OUT} reading is then expressed in ppm. For $\Delta T_A = +165^\circ C$, the device under test is cycled from $+25^\circ C$ to $-40^\circ C$ to $+125^\circ C$ to $+25^\circ C$.
- Post-reflow drift for the ISL21010 devices may shift up to 4.0mV based on simulated reflow at $260^\circ C$ peak temperature, three passes. The system design engineer must take this into account when considering the reference voltage after assembly.

Typical Performance Characteristics Curves ($V_{OUT} = 1.024V$) $V_{IN} = 3.0V$,

$I_{OUT} = 0mA$, $T_A = +25^\circ C$ unless otherwise specified.



FIGURE 3. I_{IN} vs V_{IN} , THREE UNITS



FIGURE 4. I_{IN} vs V_{IN} , OVER-TEMPERATURE



FIGURE 5. LINE REGULATION, THREE UNITS

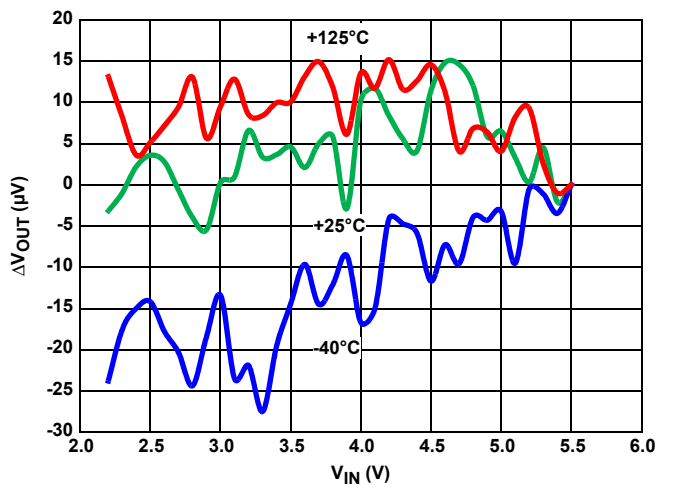

FIGURE 6. LINE REGULATION OVER-TEMPERATURE



FIGURE 7. LINE TRANSIENT RESPONSE WITH 0.22µF LOAD

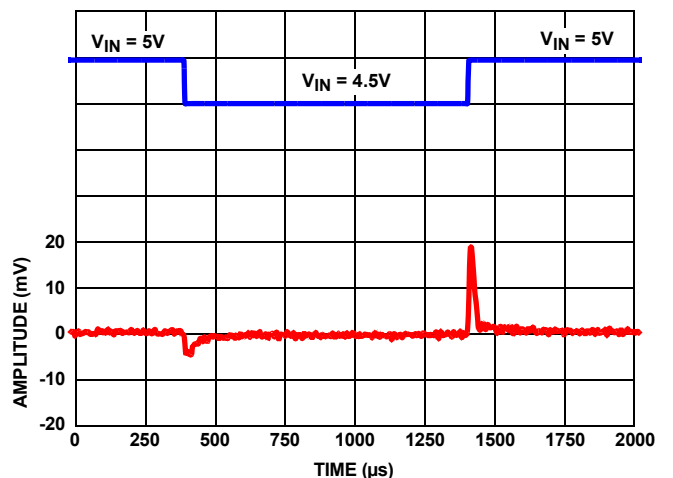

FIGURE 8. LINE TRANSIENT RESPONSE WITH 10µF LOAD

Typical Performance Characteristics Curves ($V_{OUT} = 1.024V$) $V_{IN} = 3.0V$,
 $I_{OUT} = 0mA$, $T_A = +25^\circ C$ unless otherwise specified. (Continued)



FIGURE 9. LOAD REGULATION OVER-TEMPERATURE

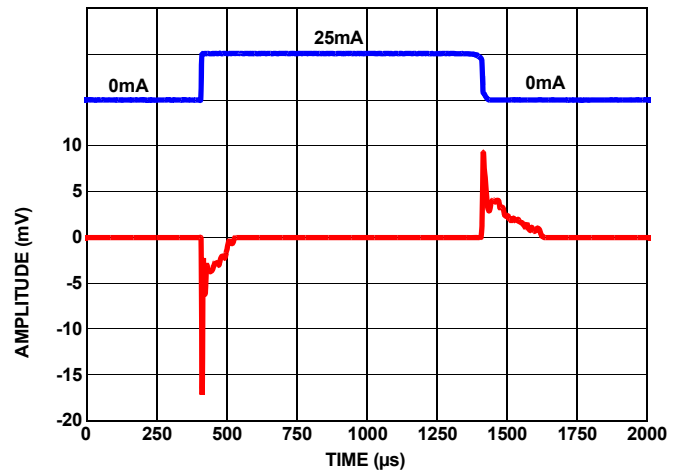

FIGURE 10. LOAD TRANSIENT RESPONSE AT 25mA LOAD AT 1µF

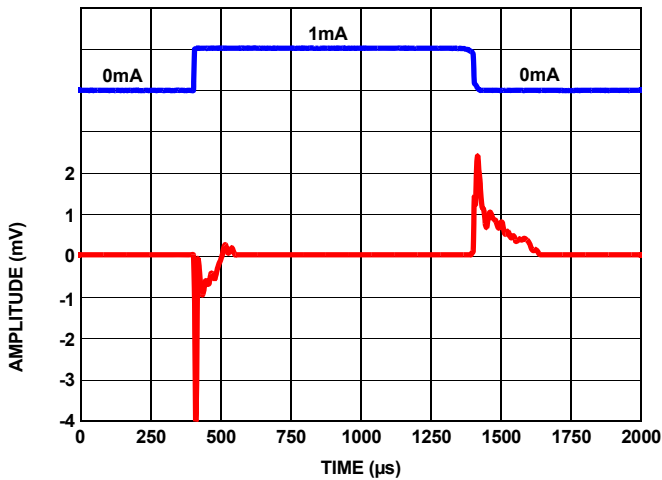

FIGURE 11. LOAD TRANSIENT RESPONSE AT 1mA LOAD AT 1µF

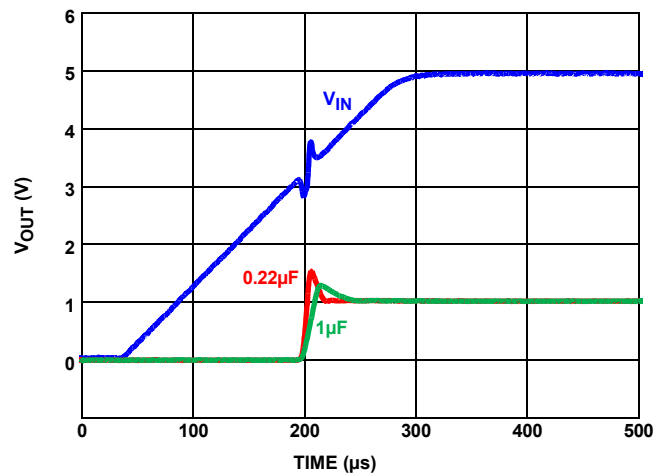

FIGURE 12. TURN-ON TIME

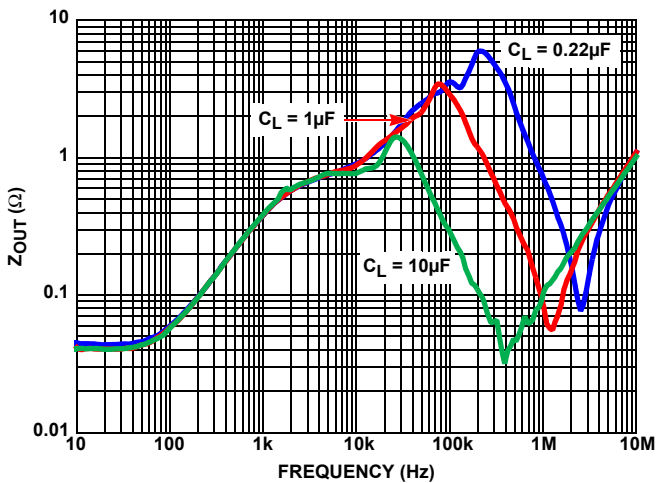

FIGURE 13. Z_{OUT} vs FREQUENCY



FIGURE 14. RIPPLE REJECTION AT DIFFERENT CAPACITIVE LOADS

Typical Performance Characteristics Curves ($V_{OUT} = 1.024V$) $V_{IN} = 3.0V$,
 $I_{OUT} = 0mA$, $T_A = +25^\circ C$ unless otherwise specified. (Continued)



FIGURE 15. DROPOUT (10mA SOURCED LOAD)



FIGURE 16. DROPOUT ZOOMED (10mA SOURCED LOAD)



FIGURE 17. V_{OUT} vs TEMPERATURE



FIGURE 18. SHORT CIRCUIT TO GND



FIGURE 19. V_{OUT} vs NOISE, 0.1Hz TO 10Hz

Typical Performance Characteristics Curves ($V_{OUT} = 1.25V$) $V_{IN} = 3.0V$,
 $I_{OUT} = 0mA$, $T_A = +25^\circ C$ unless otherwise specified.



FIGURE 20. I_{IN} vs V_{IN} , THREE UNITS



FIGURE 21. I_{IN} vs V_{IN} , OVER-TEMPERATURE

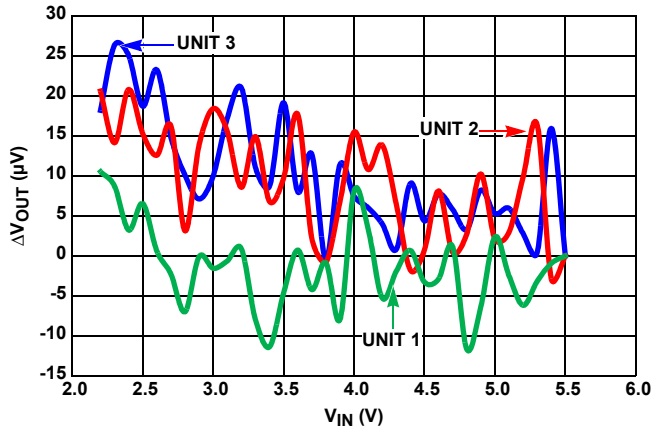

FIGURE 22. LINE REGULATION, THREE UNITS

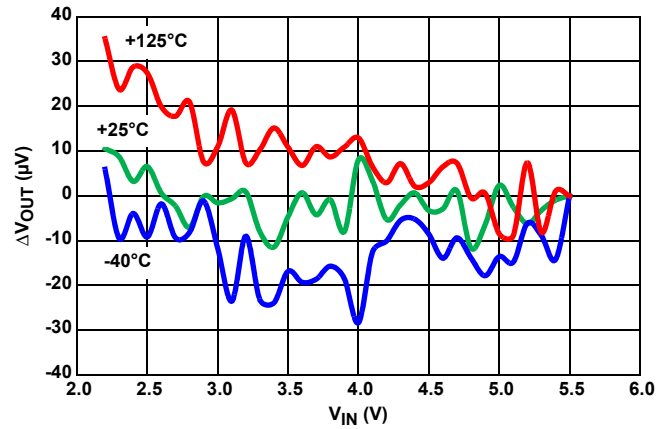

FIGURE 23. LINE REGULATION OVER-TEMPERATURE



FIGURE 24. LINE TRANSIENT RESPONSE WITH $0.1\mu F$ LOAD



FIGURE 25. LINE TRANSIENT RESPONSE WITH $10\mu F$ LOAD

Typical Performance Characteristics Curves ($V_{OUT} = 1.25V$) $V_{IN} = 3.0V$,
 $I_{OUT} = 0mA$, $T_A = +25^\circ C$ unless otherwise specified. (Continued)



FIGURE 26. LOAD REGULATION OVER-TEMPERATURE



FIGURE 27. LOAD TRANSIENT RESPONSE AT 25mA LOAD AT 1μF



FIGURE 28. LOAD TRANSIENT RESPONSE AT 1mA LOAD AT 1μF

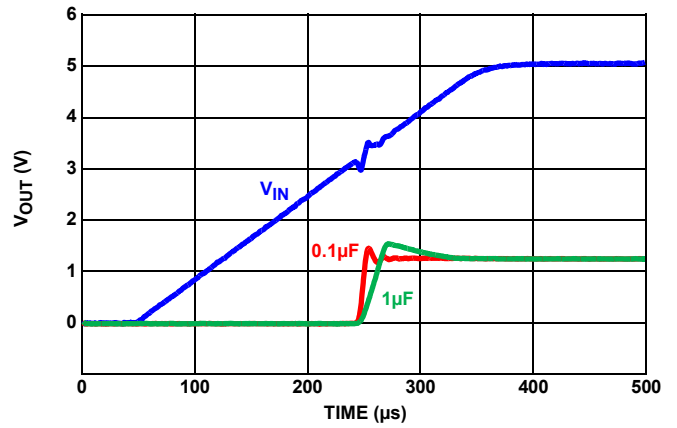

FIGURE 29. TURN-ON TIME

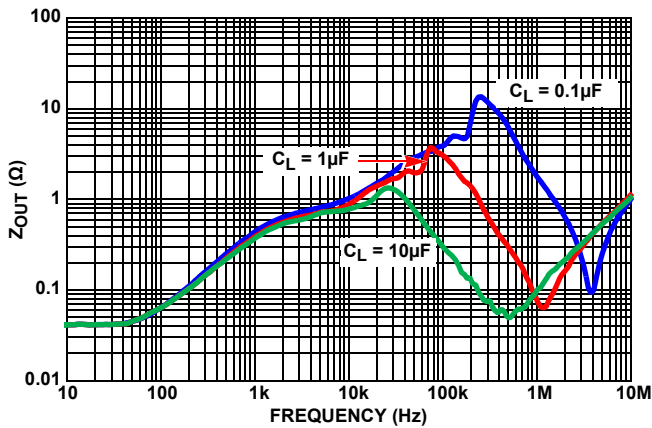

FIGURE 30. Z_{OUT} vs FREQUENCY

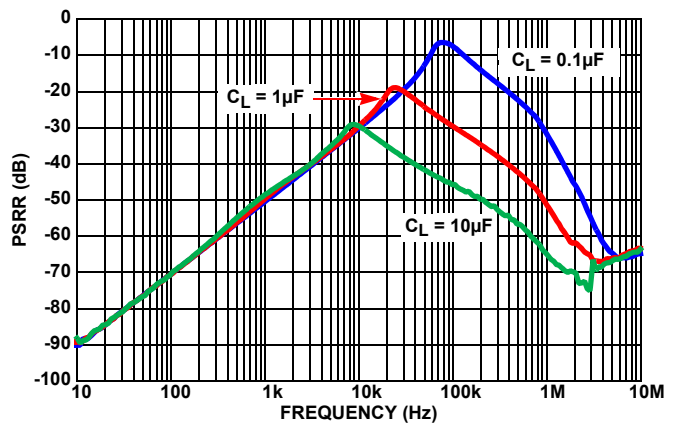

FIGURE 31. RIPPLE REJECTION AT DIFFERENT CAPACITIVE LOADS

Typical Performance Characteristics Curves ($V_{OUT} = 1.25V$) $V_{IN} = 3.0V$,
 $I_{OUT} = 0mA$, $T_A = +25^\circ C$ unless otherwise specified. (Continued)



FIGURE 32. DROPOUT (10mA SOURCED LOAD)



FIGURE 33. DROPOUT ZOOMED (10mA SOURCED LOAD)



FIGURE 34. V_{OUT} vs TEMPERATURE



FIGURE 35. SHORT-CIRCUIT TO GND



FIGURE 36. V_{OUT} vs NOISE, 0.1Hz TO 10Hz

Typical Performance Characteristics Curves ($V_{OUT} = 1.5V$) $V_{IN} = 3.0V, I_{OUT} = 0mA,$
 $T_A = +25^\circ C$ unless otherwise specified.



FIGURE 37. I_{IN} vs V_{IN} , THREE UNITS

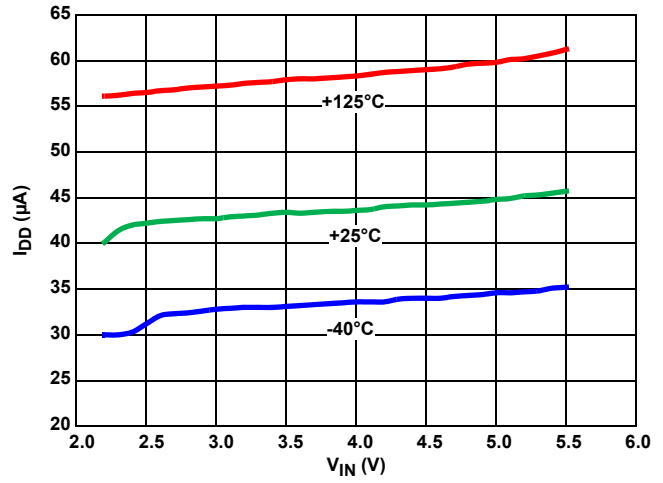

FIGURE 38. I_{IN} vs V_{IN} , OVER-TEMPERATURE

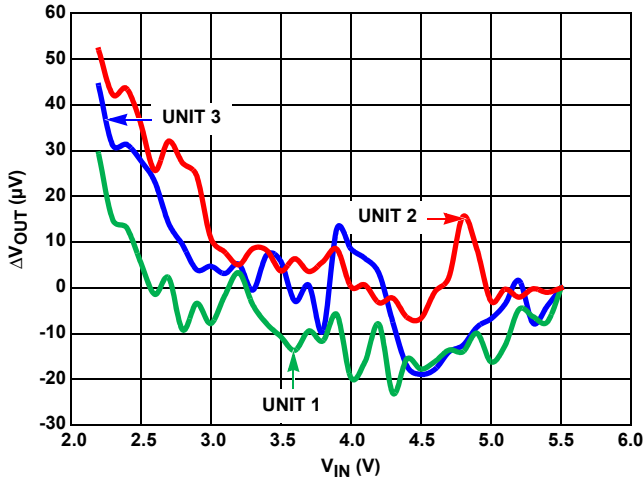

FIGURE 39. LINE REGULATION, THREE UNITS

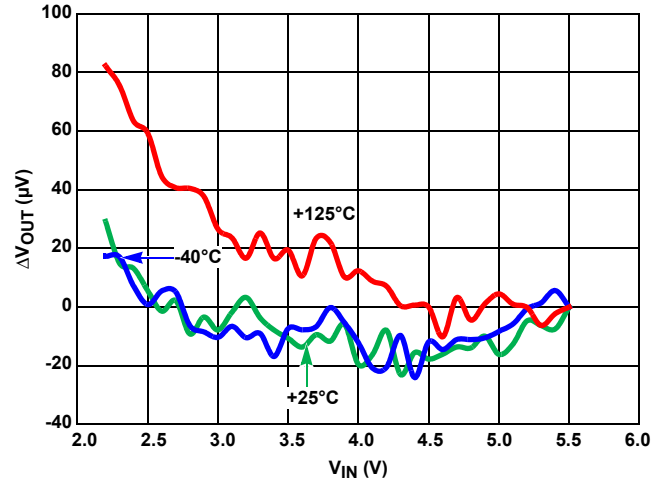

FIGURE 40. LINE REGULATION OVER-TEMPERATURE



FIGURE 41. LINE TRANSIENT RESPONSE WITH $0.1\mu F$ LOAD



FIGURE 42. LINE TRANSIENT RESPONSE WITH $10\mu F$ LOAD

Typical Performance Characteristics Curves ($V_{OUT} = 1.5V$) $V_{IN} = 3.0V, I_{OUT} = 0mA,$
 $T_A = +25^\circ C$ unless otherwise specified. (Continued)



FIGURE 43. LOAD REGULATION OVER-TEMPERATURE



FIGURE 44. LOAD TRANSIENT RESPONSE AT 25mA LOAD AT 1µF

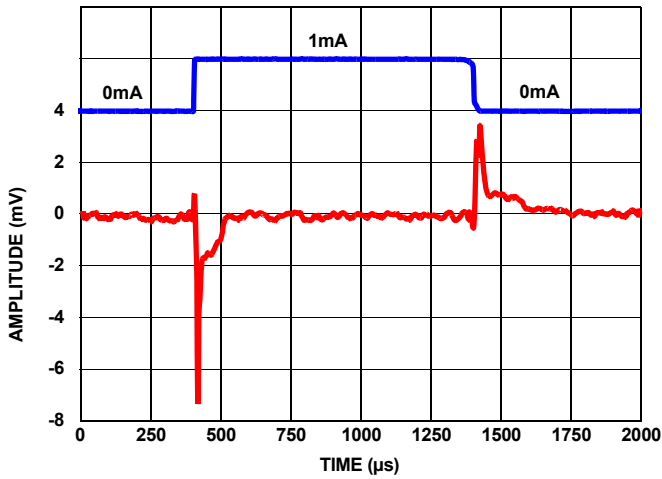

FIGURE 45. LOAD TRANSIENT RESPONSE AT 1mA LOAD AT 1µF



FIGURE 46. TURN-ON TIME

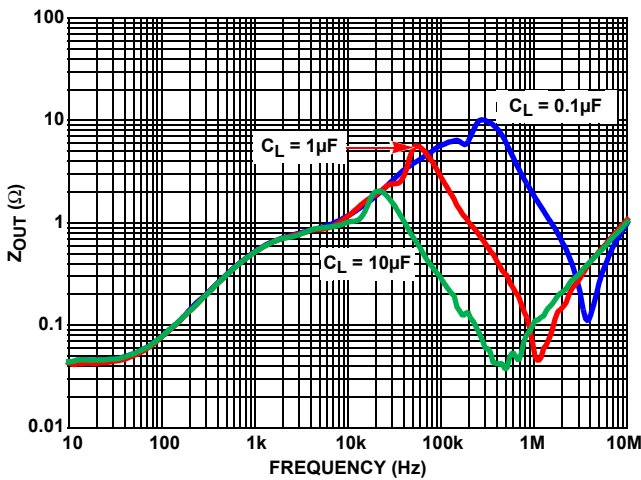

FIGURE 47. Z_{OUT} vs FREQUENCY

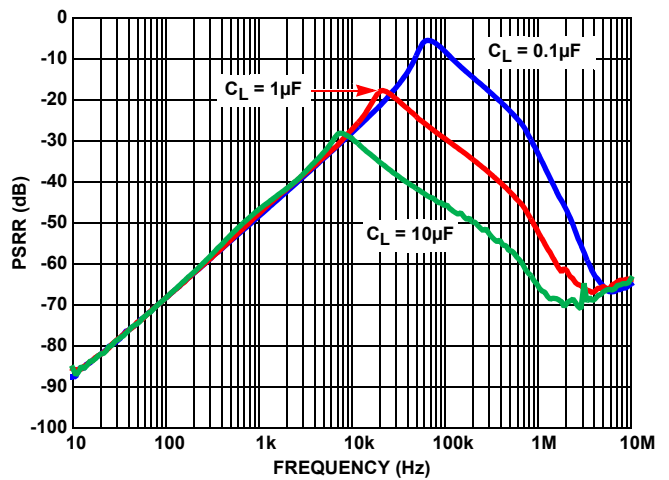

FIGURE 48. RIPPLE REJECTION AT DIFFERENT CAPACITIVE LOADS

Typical Performance Characteristics Curves ($V_{OUT} = 1.5V$) $V_{IN} = 3.0V, I_{OUT} = 0mA,$
 $T_A = +25^\circ C$ unless otherwise specified. (Continued)

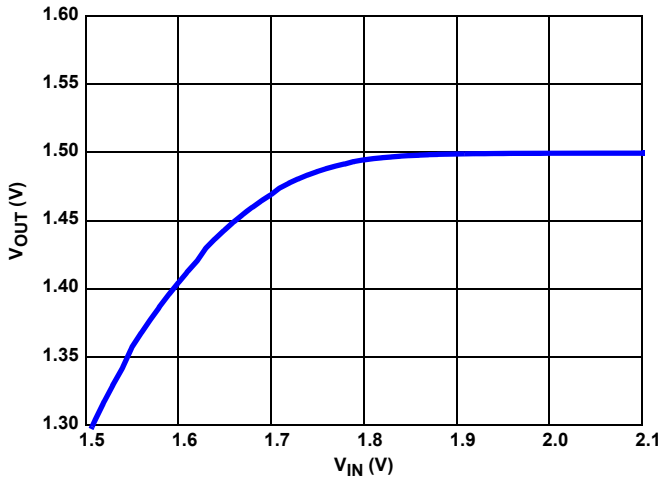

FIGURE 49. DROPOUT (10mA SOURCED LOAD)

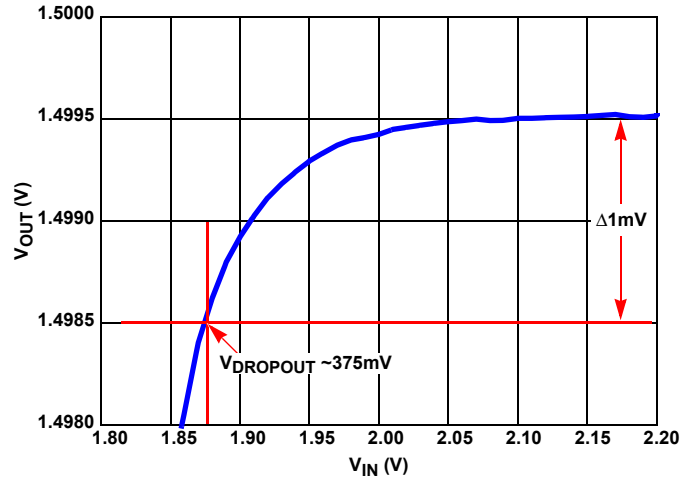

FIGURE 50. DROPOUT ZOOMED (10mA SOURCED LOAD)

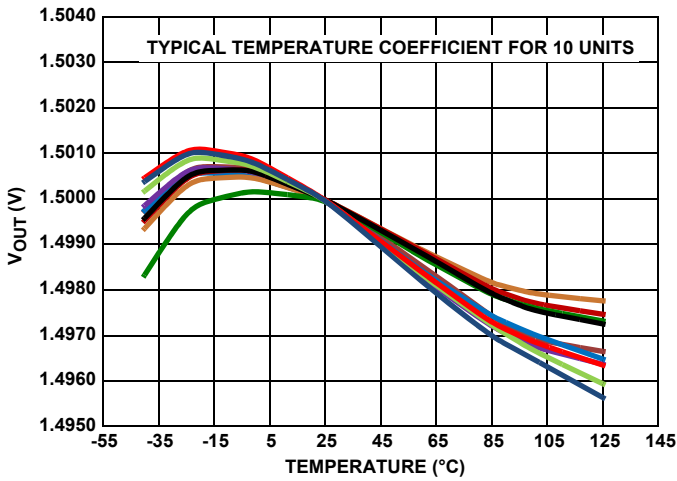

FIGURE 51. V_{OUT} vs TEMPERATURE

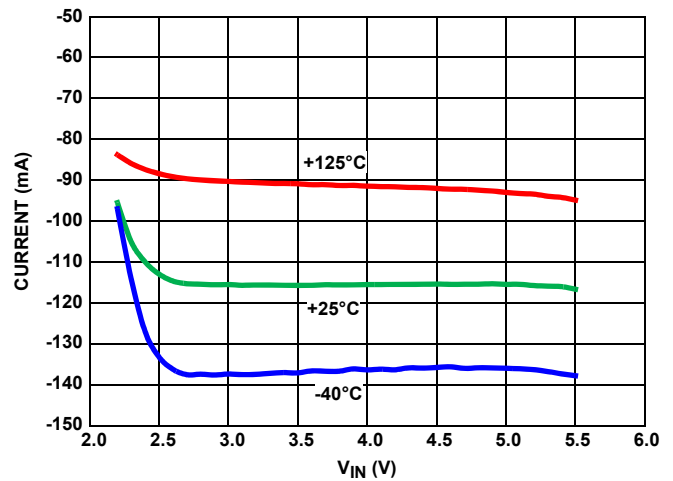

FIGURE 52. SHORT-CIRCUIT TO GND



FIGURE 53. V_{OUT} vs NOISE, 0.1Hz TO 10Hz

Typical Performance Characteristics Curves ($V_{OUT} = 2.048V$) $V_{IN} = 3.0V$,
 $I_{OUT} = 0mA$, $T_A = +25^\circ C$ unless otherwise specified.

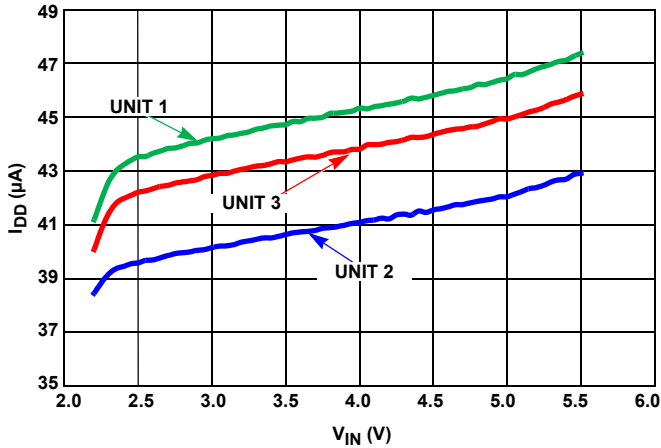

FIGURE 54. I_{IN} vs V_{IN} , THREE UNITS

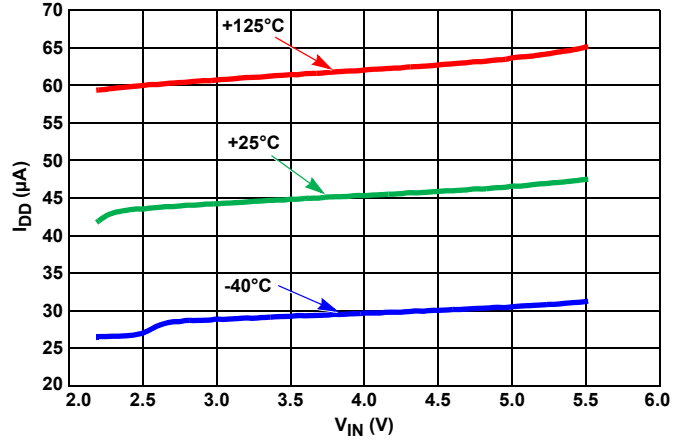

FIGURE 55. I_{IN} vs V_{IN} , OVER-TEMPERATURE



FIGURE 56. LINE REGULATION, THREE UNITS

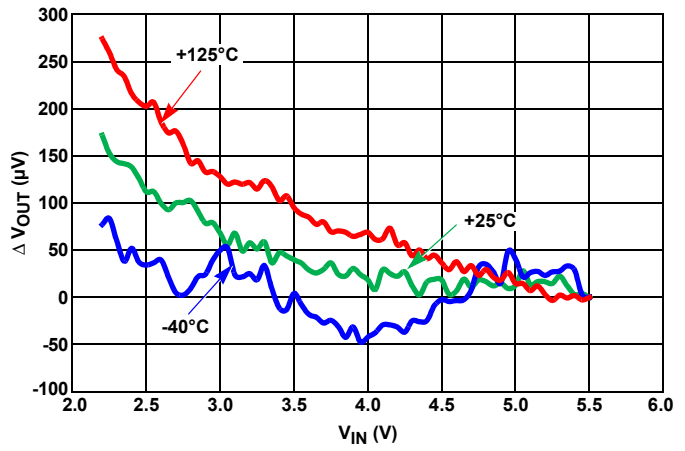

FIGURE 57. LINE REGULATION OVER-TEMPERATURE

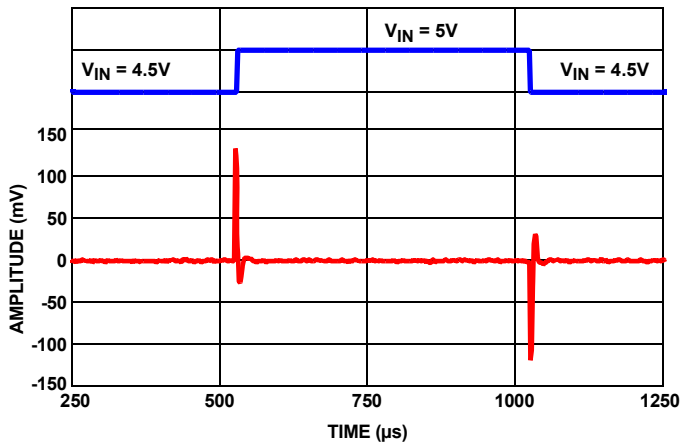

FIGURE 58. LINE TRANSIENT RESPONSE WITH $0.1\mu F$ LOAD

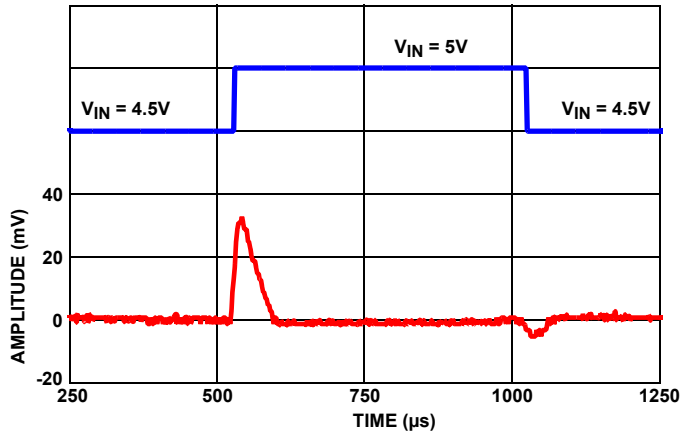

FIGURE 59. LINE TRANSIENT RESPONSE WITH $10\mu F$ LOAD

Typical Performance Characteristics Curves ($V_{OUT} = 2.048V$) $V_{IN} = 3.0V$,
 $I_{OUT} = 0mA$, $T_A = +25^\circ C$ unless otherwise specified. (Continued)

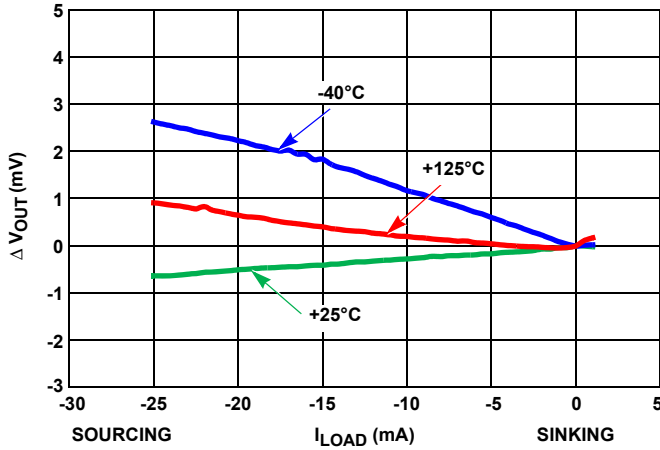

FIGURE 60. LOAD REGULATION OVER-TEMPERATURE



FIGURE 61. LOAD TRANSIENT RESPONSE AT 25mA LOAD AT 1μF



FIGURE 62. LOAD TRANSIENT RESPONSE AT 1mA LOAD AT 1μF

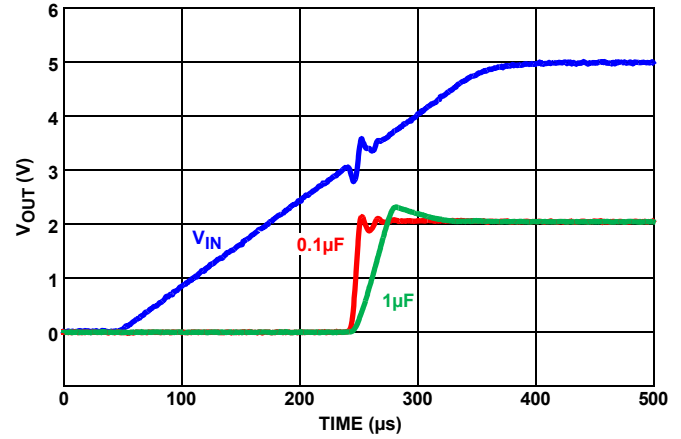

FIGURE 63. TURN-ON TIME



FIGURE 64. Z_{OUT} vs FREQUENCY



FIGURE 65. RIPPLE REJECTION AT DIFFERENT CAPACITIVE LOADS

Typical Performance Characteristics Curves ($V_{OUT} = 2.048V$) $V_{IN} = 3.0V$,
 $I_{OUT} = 0mA$, $T_A = +25^\circ C$ unless otherwise specified. (Continued)



FIGURE 66. DROPOUT (10mA SOURCED LOAD)



FIGURE 67. DROPOUT ZOOMED (10mA SOURCED LOAD)



FIGURE 68. V_{OUT} vs TEMPERATURE



FIGURE 69. SHORT-CIRCUIT TO GND



FIGURE 70. V_{OUT} vs NOISE, 0.1Hz TO 10Hz

Typical Performance Characteristics Curves ($V_{OUT} = 2.5V$) $V_{IN} = 3.0V, I_{OUT} = 0mA,$
 $T_A = +25^\circ C$ unless otherwise specified.



FIGURE 71. I_{IN} vs V_{IN} , THREE UNITS

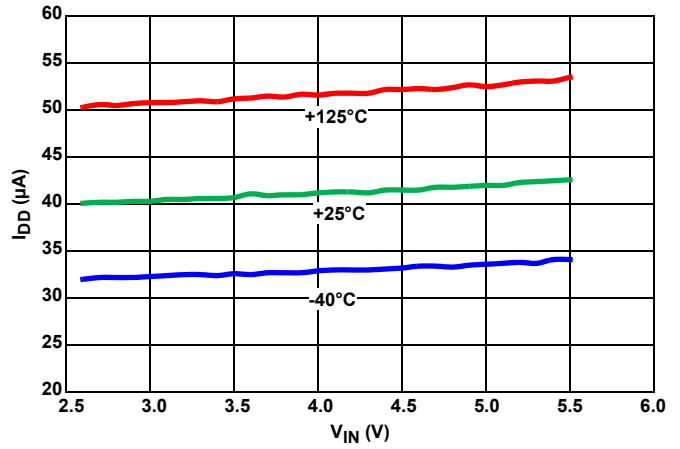

FIGURE 72. I_{IN} vs V_{IN} , OVER-TEMPERATURE



FIGURE 73. LINE REGULATION, THREE UNITS



FIGURE 74. LINE REGULATION OVER-TEMPERATURE



FIGURE 75. LINE TRANSIENT RESPONSE WITH $0.1\mu F$ LOAD



FIGURE 76. LINE TRANSIENT RESPONSE WITH $10\mu F$ LOAD

Typical Performance Characteristics Curves ($V_{OUT} = 2.5V$) $V_{IN} = 3.0V, I_{OUT} = 0mA,$
 $T_A = +25^\circ C$ unless otherwise specified. (Continued)



FIGURE 77. LOAD REGULATION OVER-TEMPERATURE



FIGURE 78. LOAD TRANSIENT RESPONSE AT 25mA LOAD AT 1µF



FIGURE 79. LOAD TRANSIENT RESPONSE AT 1mA LOAD AT 1µF



FIGURE 80. TURN-ON TIME



FIGURE 81. Z_{OUT} vs FREQUENCY



FIGURE 82. RIPPLE REJECTION AT DIFFERENT CAPACITIVE LOADS

Typical Performance Characteristics Curves ($V_{OUT} = 2.5V$) $V_{IN} = 3.0V, I_{OUT} = 0mA,$
 $T_A = +25^\circ C$ unless otherwise specified. (Continued)



FIGURE 83. DROPOUT (10mA SOURCED LOAD)

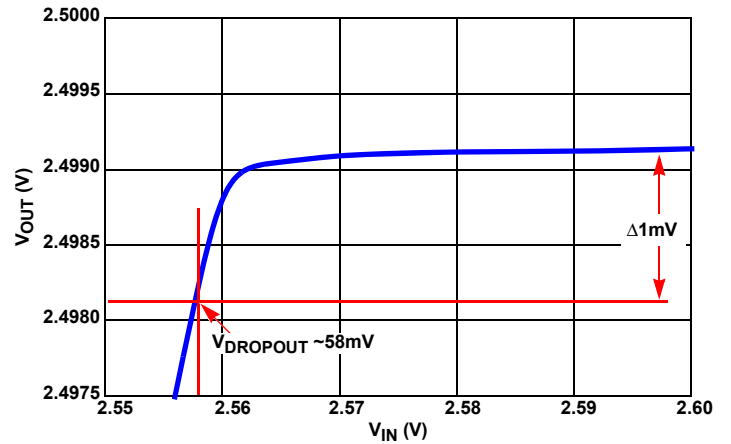

FIGURE 84. DROPOUT ZOOMED (10mA SOURCED LOAD)



FIGURE 85. V_{OUT} vs TEMPERATURE



FIGURE 86. SHORT-CIRCUIT TO GND



FIGURE 87. V_{OUT} vs NOISE, 0.1Hz TO 10Hz

Typical Performance Characteristics Curves ($V_{OUT} = 3.0V$) $V_{IN} = 5.0V, I_{OUT} = 0mA,$
 $T_A = +25^\circ C$ unless otherwise specified.



FIGURE 88. I_{IN} vs V_{IN} , THREE UNITS



FIGURE 89. I_{IN} vs V_{IN} , OVER-TEMPERATURE



FIGURE 90. LINE REGULATION, THREE UNITS

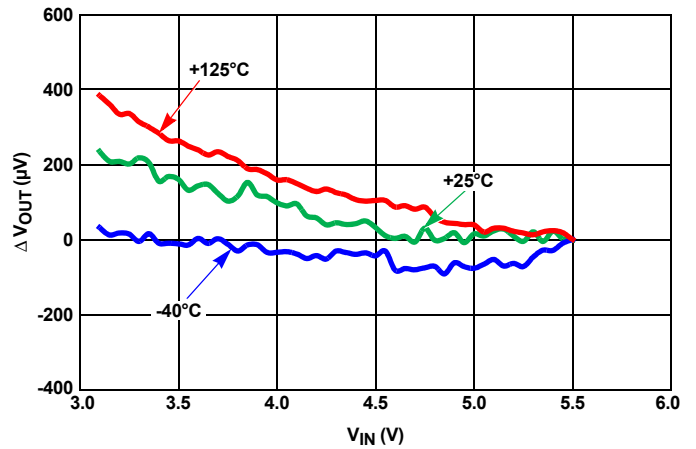

FIGURE 91. LINE REGULATION OVER-TEMPERATURE

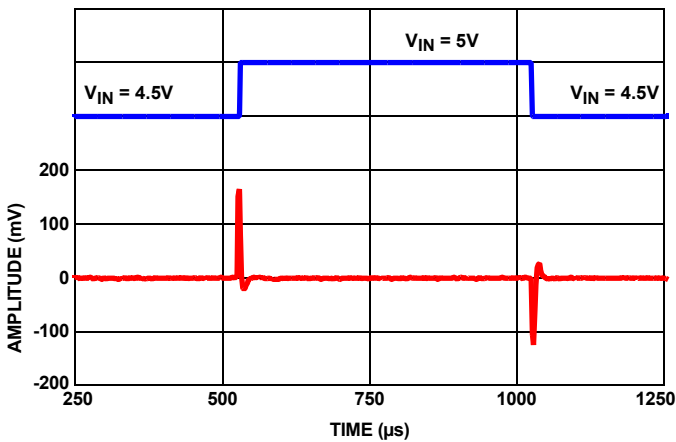

FIGURE 92. LINE TRANSIENT WITH $0.1\mu F$ LOAD



FIGURE 93. LINE TRANSIENT RESPONSE WITH $10\mu F$ LOAD

Typical Performance Characteristics Curves ($V_{OUT} = 3.0V$) $V_{IN} = 5.0V, I_{OUT} = 0mA,$
 $T_A = +25^\circ C$ unless otherwise specified. (Continued)



FIGURE 94. LOAD REGULATION OVER-TEMPERATURE



FIGURE 95. LOAD TRANSIENT RESPONSE AT 25mA LOAD AT 1µF



FIGURE 96. LOAD TRANSIENT RESPONSE AT 1mA LOAD AT 1µF



FIGURE 97. TURN-ON TIME



FIGURE 98. Z_{OUT} vs FREQUENCY



FIGURE 99. RIPPLE REJECTION AT DIFFERENT CAPACITIVE LOADS

Typical Performance Characteristics Curves ($V_{OUT} = 3.0V$) $V_{IN} = 5.0V, I_{OUT} = 0mA,$
 $T_A = +25^\circ C$ unless otherwise specified. (Continued)

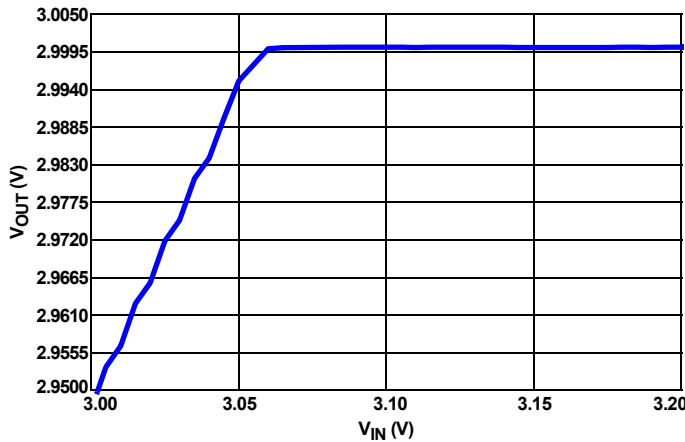

FIGURE 100. DROPOUT (10mA SOURCED LOAD)



FIGURE 101. DROPOUT ZOOMED (10mA SOURCED LOAD)



FIGURE 102. V_{OUT} vs TEMPERATURE

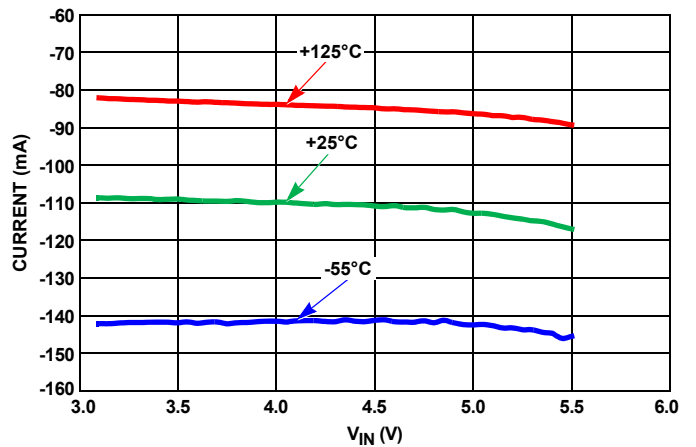

FIGURE 103. SHORT-CIRCUIT TO GND



FIGURE 104. V_{OUT} vs NOISE, 0.1Hz TO 10Hz

Typical Performance Characteristics Curves ($V_{OUT} = 3.3V$) $V_{IN} = 5.0V, I_{OUT} = 0mA,$
 $T_A = +25^\circ C$ unless otherwise specified.

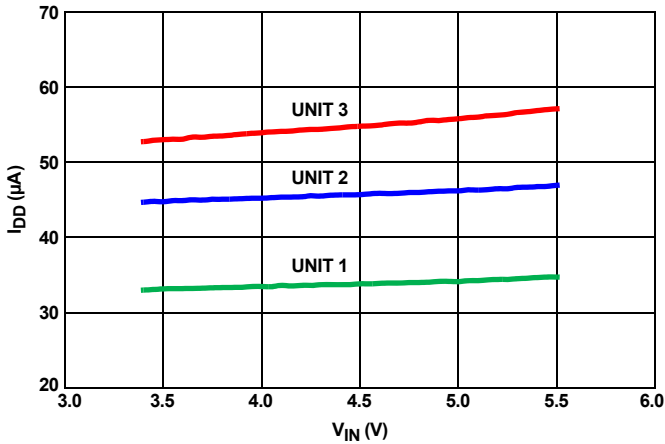

FIGURE 105. I_{IN} vs V_{IN} , THREE UNITS

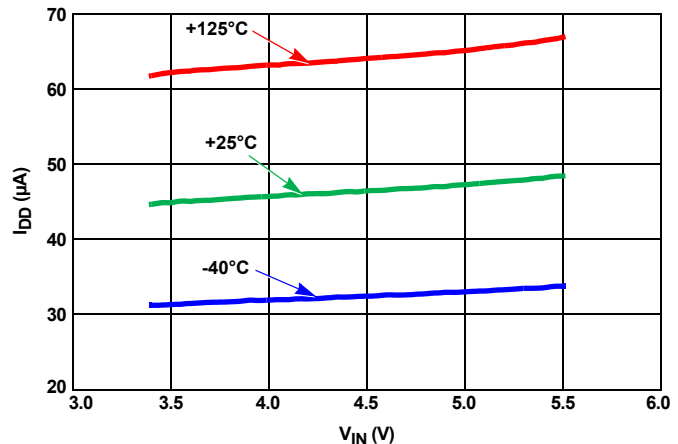

FIGURE 106. I_{IN} vs V_{IN} , OVER-TEMPERATURE

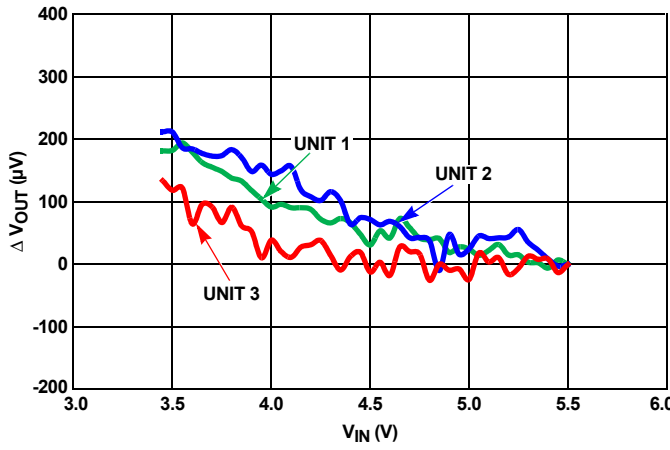

FIGURE 107. LINE REGULATION, THREE UNITS

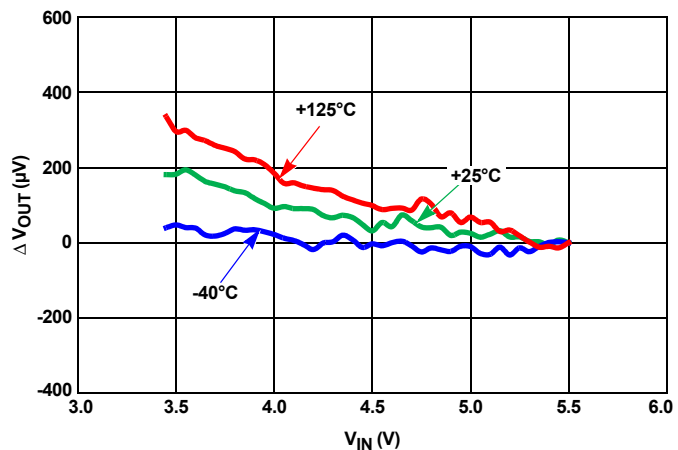

FIGURE 108. LINE REGULATION OVER-TEMPERATURE

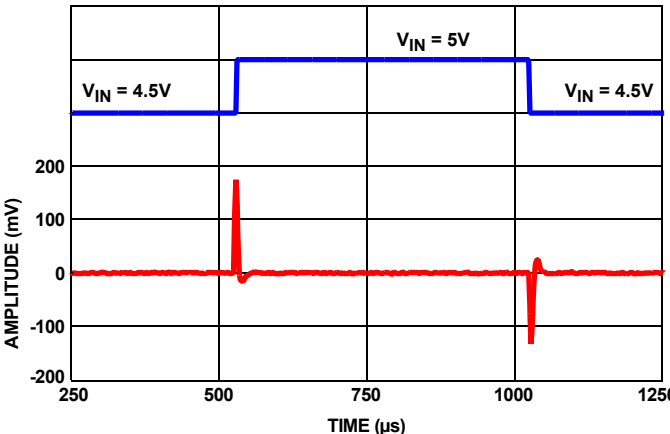

FIGURE 109. LINE TRANSIENT WITH $0.1\mu F$ LOAD

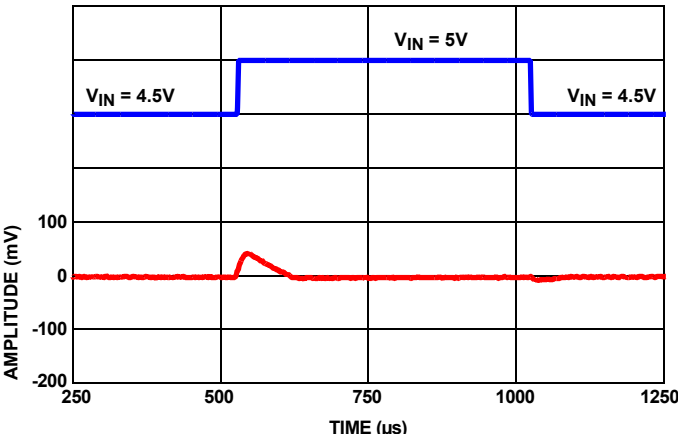

FIGURE 110. LINE TRANSIENT RESPONSE WITH $10\mu F$ LOAD

Typical Performance Characteristics Curves ($V_{OUT} = 3.3V$) $V_{IN} = 5.0V, I_{OUT} = 0mA,$
 $T_A = +25^\circ C$ unless otherwise specified. (Continued)



FIGURE 111. LOAD REGULATION OVER-TEMPERATURE



FIGURE 112. LOAD TRANSIENT RESPONSE AT 25mA LOAD AT 1µF



FIGURE 113. LOAD TRANSIENT RESPONSE AT 1mA LOAD AT 1µF



FIGURE 114. TURN-ON TIME



FIGURE 115. Z_{OUT} vs FREQUENCY



FIGURE 116. RIPPLE REJECTION AT DIFFERENT CAPACITIVE LOADS

Typical Performance Characteristics Curves ($V_{OUT} = 3.3V$) $V_{IN} = 5.0V, I_{OUT} = 0mA,$
 $T_A = +25^\circ C$ unless otherwise specified. (Continued)



FIGURE 117. DROPOUT (10mA SOURCED LOAD)



FIGURE 118. DROPOUT ZOOMED (10mA SOURCED LOAD)



FIGURE 119. V_{OUT} vs TEMPERATURE



FIGURE 120. SHORT-CIRCUIT TO GND



FIGURE 121. V_{OUT} vs NOISE, 0.1Hz TO 10Hz

Typical Performance Characteristics Curves ($V_{OUT} = 4.096V$) $V_{IN} = 3.0V$,
 $I_{OUT} = 0mA$, $T_A = +25^\circ C$ unless otherwise specified.



FIGURE 122. I_{IN} vs V_{IN} , THREE UNITS



FIGURE 123. I_{IN} vs V_{IN} , OVER-TEMPERATURE



FIGURE 124. LINE REGULATION, THREE UNITS



FIGURE 125. LINE REGULATION OVER-TEMPERATURE



FIGURE 126. LINE TRANSIENT RESPONSE WITH 0.1μF LOAD



FIGURE 127. LINE TRANSIENT RESPONSE WITH 10μF LOAD

Typical Performance Characteristics Curves ($V_{OUT} = 4.096V$) $V_{IN} = 3.0V$,

$I_{OUT} = 0mA$, $T_A = +25^\circ C$ unless otherwise specified. (Continued)



FIGURE 128. LOAD REGULATION OVER-TEMPERATURE



FIGURE 129. LOAD TRANSIENT RESPONSE AT 25mA LOAD AT 1μF



FIGURE 130. LOAD TRANSIENT RESPONSE AT 1mA LOAD AT 1μF

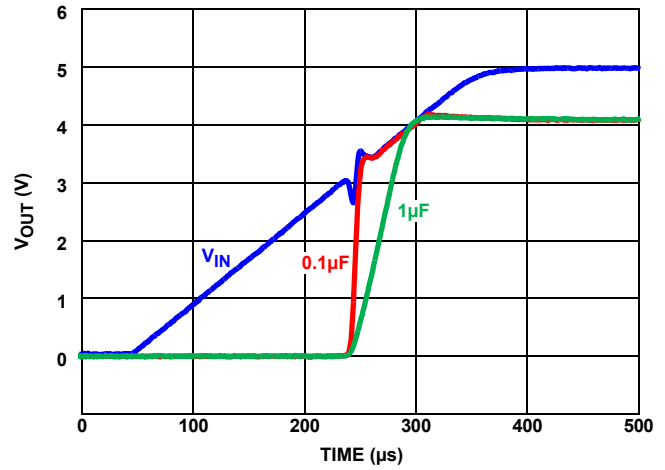

FIGURE 131. TURN-ON TIME



FIGURE 132. Z_{OUT} vs FREQUENCY

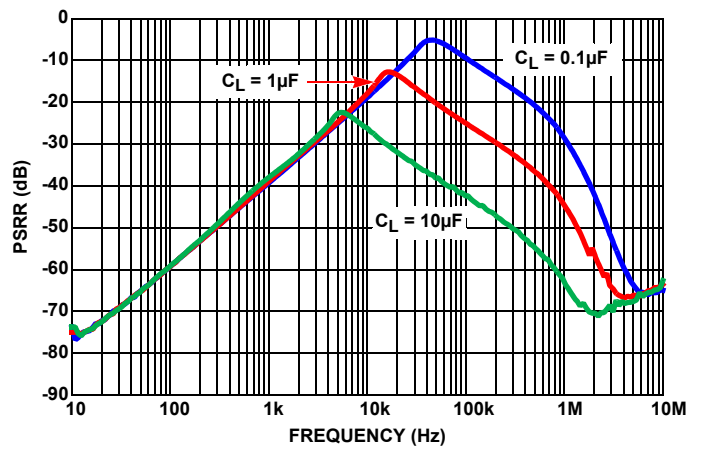

FIGURE 133. RIPPLE REJECTION AT DIFFERENT CAPACITIVE LOADS

Typical Performance Characteristics Curves ($V_{OUT} = 4.096V$) $V_{IN} = 3.0V$,
 $I_{OUT} = 0mA$, $T_A = +25^\circ C$ unless otherwise specified. (Continued)

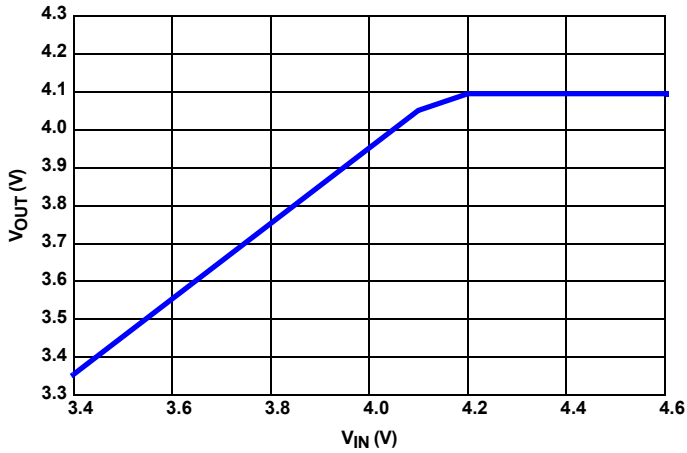

FIGURE 134. DROPOUT (10mA SOURCED LOAD)

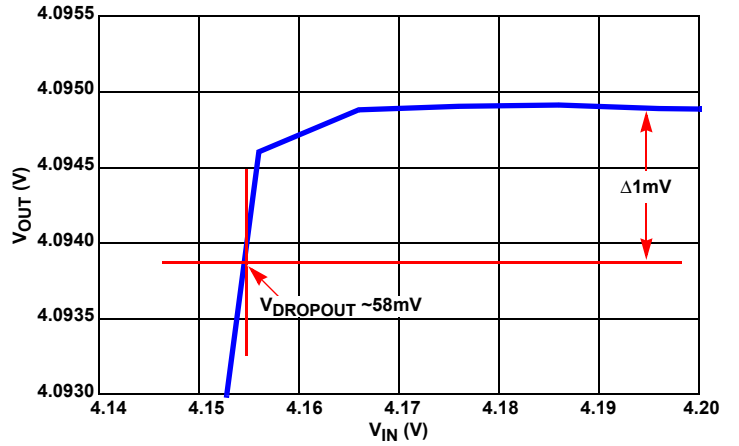

FIGURE 135. DROPOUT ZOOMED (10mA SOURCED LOAD)

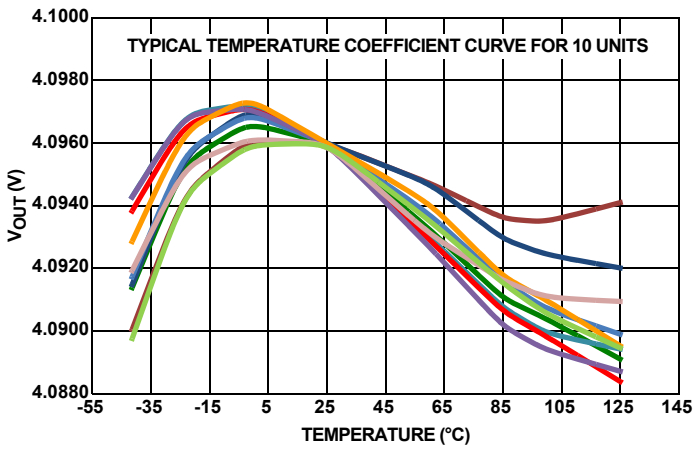

FIGURE 136. V_{OUT} vs TEMPERATURE

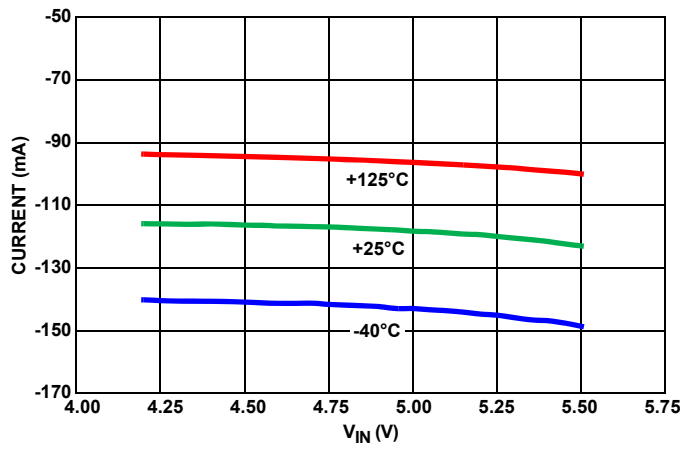

FIGURE 137. SHORT-CIRCUIT TO GND



FIGURE 138. V_{OUT} vs NOISE, 0.1Hz TO 10Hz

Applications Information

Micropower Operation

The ISL21010 consumes very low supply current due to the proprietary bandgap technology. Low noise performance is achieved using optimized biasing techniques. Supply current is typically 48 μ A and noise in the 0.1Hz to 10Hz bandwidth is 58 μ V_{P-P} to 100 μ V_{P-P} (V_{OUT} = 2.048V, 3.0V, and 3.3V) benefiting precision, low noise portable applications such as handheld meters and instruments.

Data converters in particular can use the ISL21010 as an external voltage reference. Low power DAC and ADC circuits achieve maximum resolution with lowest noise. The ISL21010 maintains output voltage during conversion cycles with fast response, although it is helpful to add an output capacitor, typically 1 μ F.

Board Mounting Considerations

For applications requiring the highest accuracy, review the board mounting location. The ISL21010 uses a plastic SOIC package, which subjects the die to mild stresses when the Printed Circuit Board (PCB) is heated and cooled and slightly changes the shape. Placing the device in areas subject to slight twisting degrades the accuracy of the reference voltage due to these die stresses. It is normally best to place the device near the edge of a board, or on the shortest side because the axis of bending is most limited at that location. Mounting the device in a cutout also minimizes flex. Mounting the device on flexprint or extremely thin PCB material causes reference accuracy loss.

Board Assembly Considerations

Bandgap references provide high accuracy and low temperature drift but some PCB assembly precautions are necessary. Normal output voltage shifts of 100 μ V to 4mV can be expected with Pb-free reflow profiles or wave solder on multilayer FR4 PCBs. Avoid excessive heat or extended exposure to high reflow or wave solder temperatures; this can reduce device initial accuracy.

Noise Performance and Reduction

The recommended capacitive load range for the ISL21010 is from 0.1 μ F to 10.0 μ F (0.22 μ F minimum required for 1.024V option) to ensure stability and best transient performance. Parallel 0.1 μ F (0.22 μ F for 1.024V) and 10 μ F capacitors can be used to optimize performance as well. The noise specification stated in the Electrical Specification tables (starting on [page 5](#)) is for 0.1 μ F (0.22 μ F for 1.024V option) capacitive load. Larger values reduce the output noise level.

Cycling V_{IN} On-Off-On (CAUTION)

The ISL21010 is NOT designed for applications requiring rapid cycling of V_{IN} . Power the V_{IN} pin down to 0V for one minute before turning the part back on.

Revision History

The revision history provided is for informational purposes only and is believed to be accurate, but not warranted. Please visit our website to make sure you have the latest revision.

| DATE | REVISION | CHANGE |
|--------------|----------|---|
| Apr 19, 2019 | FN7896.6 | Added Cycling V_{IN} On-Off-On (CAUTION) section on page 34. Updated disclaimer. |
| Mar 30, 2018 | FN7896.5 | Updated Related Literature section. Added new parts and updated notes in the Ordering Information table on page 4. Removed About Intersil section and updated disclaimer. |
| Feb 12, 2016 | FN7896.4 | Removed DAQ on a stick reference from "Related Literature" on page 1. Updated "Ordering Information" on page 4 by adding column for tape and reel option. Updated HBM value to kV (5500V to 5.5kV) in "Absolute Maximum Ratings" on page 5. |
| Jan 8, 2015 | FN7896.3 | On page 1, in the Related Literature section added AN1853 and AN1883. On page 4, updated the ordering information table by adding the (-T7A) products. Changed the y-axis units on Figure 19 on page 12 from "(V)" to "(μ V)". |
| Jun 23, 2014 | FN7896.2 | Added Curves for Voltage Refs 1.25V, 1.024V, 1.5V, 2.5V and 4.096V Updated POD with following changes: In Detail A, changed lead width dimension from 0.13+/-0.05 to 0.085-0.19 Changed dimension of foot of lead from 0.31+/-0.10 to 0.38+/-0.10 In Land Pattern, added 0.4 Rad Typ dimension In Side View, changed height of package from 0.91+/-0.03 to 0.95+/-0.07 |
| Nov 28, 2011 | FN7896.1 | On page 1, Features: removed "Coming Soon" from ISL21010-10, -12, -15; ISL21010-25; and ISL21010-40 voltage options; combined -20 option with -10, -12, -15; changed -40 to -41 On page 4, Ordering Information: added parts ISL21010DFH310Z-TK, ISL21010DFH312Z-TK, ISL21010CFH315Z-TK, ISL21010CFH325Z-TK, ISL21010CFH341Z-TK On page 5, Recommended Operating Conditions: added $V_{OUT} = 1.024V, 1.25V, 1.5V, 2.048V, 2.2V$ to 5.5V; $V_{OUT} = 2.5V, \dots, 2.6V$ to 5.5V; $V_{OUT} = 4.096V, \dots, 4.2V$ to 5.5V On page 5 through page 9, added Electrical Specifications tables for (ISL21010-10, $V_{OUT} = 1.024V$), (ISL21010-12, $V_{OUT} = 1.25V$), (ISL21010-15, $V_{OUT} = 1.5V$), (ISL21010-41, $V_{OUT} = 4.096V$) On page 7, Electrical Specifications (ISL21010-20, $V_{OUT} = 2.048V$): changed V_{OUT}/T_A , Thermal Hysteresis, TYP from 50 to 100 On page 9, Note 9: changed "... where V_{OUT} drops 1mV from $V_{IN} = 5.0V$ at $T_A = +25^\circ C$." to "... where V_{OUT} drops 1mV from $V_{IN} = \text{nominal}$ at $T_A = +25^\circ C$." On page 26, Figure 95, changed title from "LOAD REGULATION OVER-TEMPERATURE" to "LOAD TRANSIENT RESPONSE AT 25mA LOAD". Figure 27, changed title from "LOAD TRANSIENT RESPONSE" to "LOAD TRANSIENT RESPONSE AT 1mA LOAD". On page 27, Figure 100, and page 30, Figure 117, changed figure titles to indicate 10mA instead of 1mA source load. On page 29, Figure 112, changed title from LOAD REGULATION OVER-TEMPERATURE" to "LOAD TRANSIENT RESPONSE AT 25mA LOAD". Figure 113, changed title from "LOAD TRANSIENT RESPONSE" to "LOAD TRANSIENT RESPONSE AT 1mA LOAD" On page 34, under "Noise Performance and Reduction", added reference to capacitive load range for 1.024V option. |
| Aug 9, 2011 | FN7896.0 | Initial Release |

Package Outline Drawing

For the most recent package outline drawing, see [P3.064](#).

P3.064

3 LEAD SMALL OUTLINE TRANSISTOR PLASTIC PACKAGE (SOT23-3)

Rev 3, 3/12

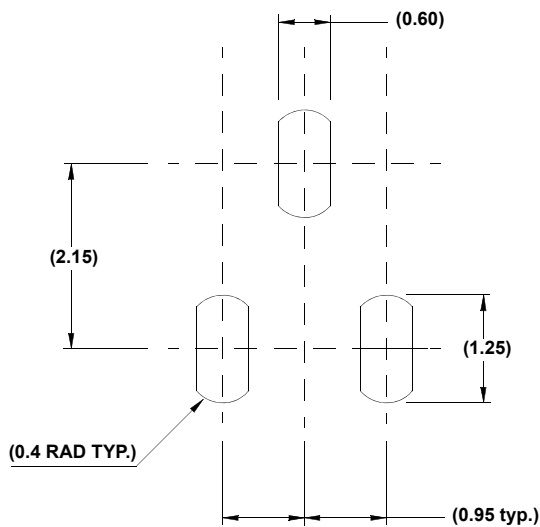
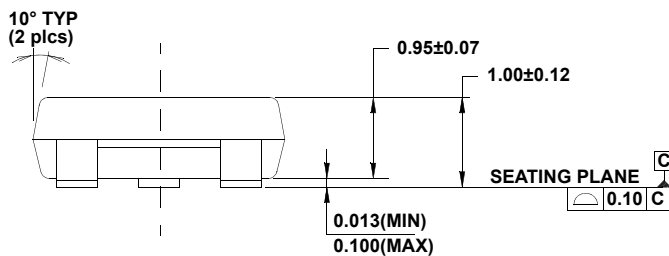
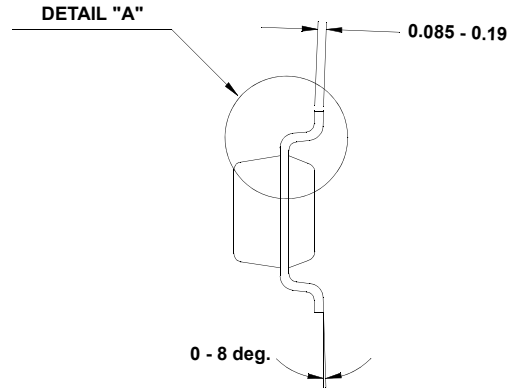
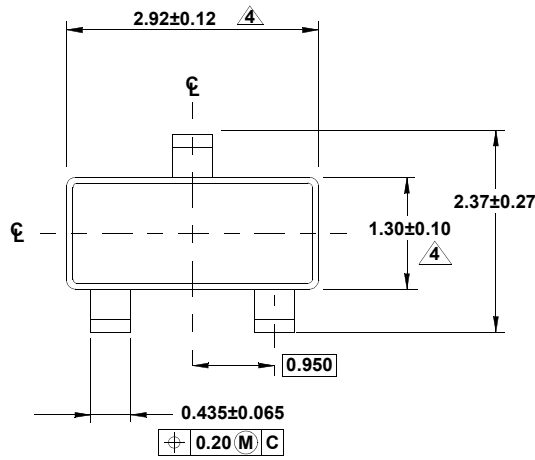

NOTES:

1. Dimensions are in millimeters. Dimensions in () for Reference Only.
2. Dimensioning and tolerancing conform to AMSEY14.5m-1994.
3. Reference JEDEC TO-236.
4. Dimension does not include interlead flash or protrusions. Interlead flash or protrusions shall not exceed 0.25mm per side.
5. Footlength is measured at reference to gauge plane.

Notice

1. Descriptions of circuits, software and other related information in this document are provided only to illustrate the operation of semiconductor products and application examples. You are fully responsible for the incorporation or any other use of the circuits, software, and information in the design of your product or system. Renesas Electronics disclaims any and all liability for any losses and damages incurred by you or third parties arising from the use of these circuits, software, or information.
 2. Renesas Electronics hereby expressly disclaims any warranties against and liability for infringement or any other claims involving patents, copyrights, or other intellectual property rights of third parties, by or arising from the use of Renesas Electronics products or technical information described in this document, including but not limited to, the product data, drawings, charts, programs, algorithms, and application examples.
 3. No license, express, implied or otherwise, is granted hereby under any patents, copyrights or other intellectual property rights of Renesas Electronics or others.
 4. You shall not alter, modify, copy, or reverse engineer any Renesas Electronics product, whether in whole or in part. Renesas Electronics disclaims any and all liability for any losses or damages incurred by you or third parties arising from such alteration, modification, copying or reverse engineering.
 5. Renesas Electronics products are classified according to the following two quality grades: "Standard" and "High Quality". The intended applications for each Renesas Electronics product depends on the product's quality grade, as indicated below.
 - "Standard": Computers; office equipment; communications equipment; test and measurement equipment; audio and visual equipment; home electronic appliances; machine tools; personal electronic equipment; industrial robots; etc.
 - "High Quality": Transportation equipment (automobiles, trains, ships, etc.); traffic control (traffic lights); large-scale communication equipment; key financial terminal systems; safety control equipment; etc.Unless expressly designated as a high reliability product or a product for harsh environments in a Renesas Electronics data sheet or other Renesas Electronics document, Renesas Electronics products are not intended or authorized for use in products or systems that may pose a direct threat to human life or bodily injury (artificial life support devices or systems; surgical implantations; etc.), or may cause serious property damage (space system; undersea repeaters; nuclear power control systems; aircraft control systems; key plant systems; military equipment; etc.). Renesas Electronics disclaims any and all liability for any damages or losses incurred by you or any third parties arising from the use of any Renesas Electronics product that is inconsistent with any Renesas Electronics data sheet, user's manual or other Renesas Electronics document.
 6. When using Renesas Electronics products, refer to the latest product information (data sheets, user's manuals, application notes, "General Notes for Handling and Using Semiconductor Devices" in the reliability handbook, etc.), and ensure that usage conditions are within the ranges specified by Renesas Electronics with respect to maximum ratings, operating power supply voltage range, heat dissipation characteristics, installation, etc. Renesas Electronics disclaims any and all liability for any malfunctions, failure or accident arising out of the use of Renesas Electronics products outside of such specified ranges.
 7. Although Renesas Electronics endeavors to improve the quality and reliability of Renesas Electronics products, semiconductor products have specific characteristics, such as the occurrence of failure at a certain rate and malfunctions under certain use conditions. Unless designated as a high reliability product or a product for harsh environments in a Renesas Electronics data sheet or other Renesas Electronics document, Renesas Electronics products are not subject to radiation resistance design. You are responsible for implementing safety measures to guard against the possibility of bodily injury, injury or damage caused by fire, and/or danger to the public in the event of a failure or malfunction of Renesas Electronics products, such as safety design for hardware and software, including but not limited to redundancy, fire control and malfunction prevention, appropriate treatment for aging degradation or any other appropriate measures. Because the evaluation of microcomputer software alone is very difficult and impractical, you are responsible for evaluating the safety of the final products or systems manufactured by you.
 8. Please contact a Renesas Electronics sales office for details as to environmental matters such as the environmental compatibility of each Renesas Electronics product. You are responsible for carefully and sufficiently investigating applicable laws and regulations that regulate the inclusion or use of controlled substances, including without limitation, the EU RoHS Directive, and using Renesas Electronics products in compliance with all these applicable laws and regulations. Renesas Electronics disclaims any and all liability for damages or losses occurring as a result of your noncompliance with applicable laws and regulations.
 9. Renesas Electronics products and technologies shall not be used for or incorporated into any products or systems whose manufacture, use, or sale is prohibited under any applicable domestic or foreign laws or regulations. You shall comply with any applicable export control laws and regulations promulgated and administered by the governments of any countries asserting jurisdiction over the parties or transactions.
 10. It is the responsibility of the buyer or distributor of Renesas Electronics products, or any other party who distributes, disposes of, or otherwise sells or transfers the product to a third party, to notify such third party in advance of the contents and conditions set forth in this document.
 11. This document shall not be reprinted, reproduced or duplicated in any form, in whole or in part, without prior written consent of Renesas Electronics.
 12. Please contact a Renesas Electronics sales office if you have any questions regarding the information contained in this document or Renesas Electronics products.
- (Note1) "Renesas Electronics" as used in this document means Renesas Electronics Corporation and also includes its directly or indirectly controlled subsidiaries.
- (Note2) "Renesas Electronics product(s)" means any product developed or manufactured by or for Renesas Electronics.

(Rev.4.0-1 November 2017)

Corporate Headquarters

TOYOSU FORESIA, 3-2-24 Toyosu,
Koto-ku, Tokyo 135-0061, Japan
www.renesas.com

Contact Information

For further information on a product, technology, the most up-to-date version of a document, or your nearest sales office, please visit:
www.renesas.com/contact/

Trademarks

Renesas and the Renesas logo are trademarks of Renesas Electronics Corporation. All trademarks and registered trademarks are the property of their respective owners.



Компания «ЭлектроПласт» предлагает заключение долгосрочных отношений при поставках импортных электронных компонентов на взаимовыгодных условиях!

Наши преимущества:

- Оперативные поставки широкого спектра электронных компонентов отечественного и импортного производства напрямую от производителей и с крупнейших мировых складов;
- Поставка более 17-ти миллионов наименований электронных компонентов;
- Поставка сложных, дефицитных, либо снятых с производства позиций;
- Оперативные сроки поставки под заказ (от 5 рабочих дней);
- Экспресс доставка в любую точку России;
- Техническая поддержка проекта, помощь в подборе аналогов, поставка прототипов;
- Система менеджмента качества сертифицирована по Международному стандарту ISO 9001;
- Лицензия ФСБ на осуществление работ с использованием сведений, составляющих государственную тайну;
- Поставка специализированных компонентов (Xilinx, Altera, Analog Devices, Intersil, Interpoint, Microsemi, Aeroflex, Peregrine, Syfer, Eurofarad, Texas Instrument, Miteq, Cobham, E2V, MA-COM, Hittite, Mini-Circuits, General Dynamics и др.);

Помимо этого, одним из направлений компании «ЭлектроПласт» является направление «Источники питания». Мы предлагаем Вам помощь Конструкторского отдела:

- Подбор оптимального решения, техническое обоснование при выборе компонента;
- Подбор аналогов;
- Консультации по применению компонента;
- Поставка образцов и прототипов;
- Техническая поддержка проекта;
- Защита от снятия компонента с производства.



Как с нами связаться

Телефон: 8 (812) 309 58 32 (многоканальный)

Факс: 8 (812) 320-02-42

Электронная почта: org@eplast1.ru

Адрес: 198099, г. Санкт-Петербург, ул. Калинина, дом 2, корпус 4, литера А.