

THIS DRAWING IS UNPUBLISHED. RELEASED FOR PUBLICATION
 © COPYRIGHT - By - ALL RIGHTS RESERVED.

LOC	DIST	REVISIONS					
		P	LTR	DESCRIPTION	DATE	DWN	APVD
			D9	REVISED PER ECO-12-012202	03JUL12	KH	MS

PHYSICAL PROPERTIES:
 HOUSING MATERIAL: PBT
 FLAMMABILITY: UL94V-0
 COLOR: BLACK

TERMINAL:
 TERMINALS: BRASS, TIN PLATED
 SCREWS: 6-32, STEEL, NICKEL PLATED

MECHANICAL:
 PITCH (TERMINAL SPACING): 9.50mm (.374")
 WIRE RANGE: 12-22 AWG
 RECOMMENDED TIGHTENING TORQUE: 12IN-LBS MAX.

ELECTRICAL PROPERTIES:
 MAXIMUM CURRENT: 20A
 OPERATING VOLTAGE: 300V

ENVIRONMENTAL PROPERTIES:
 OPERATING TEMP RANGE: -40°C TO 120°C

- △ 1 SCREWS ON ONE SIDE IN WIRE READY POSITION.
- △ 2 SEE FIGURE.
- △ 3 WHITE INK STAMP.
- △ 4 NICKEL PLATED BRASS SCREWS.
- △ 5 PRELIMINARY PART NUMBER.
- △ 6 TE CONNECTIVITY LOGO LOCATED APPROXIMATE AREA SHOWN.

LOC	DIST	P	LTR	DESCRIPTION	DATE	DWN	APVD
△5 2	104.7	112.2	-	-	10	-	4-1546307-7
△5 2	104.7	112.2	-	-	10	-	4-1546307-6
△5 4	104.7	112.2	-	-	10	-	4-1546307-5
△5 2 1	104.7	112.2	-	-	10	-	3-1546307-3
	104.7	112.2	-	-	10	-	1-1546307-0
△5 3 2 1	95.2	102.7	-	9	9	-	5-1546307-0
△5 3 2 1	95.2	102.7	4	9	9	-	4-1546307-9
△3 2 1	95.2	102.7	4	9	9	-	4-1546307-8
	95.2	102.7	-	-	9	-	1546307-9
	85.7	93.2	-	-	8	-	1546307-8
	76.2	83.7	-	-	7	-	1546307-7
△5 4	66.7	74.2	-	-	6	-	4-1546307-4
	66.7	74.2	-	-	6	-	1546307-6
△5 2	57.2	64.7	-	-	5	-	4-1546307-3
△5 2	57.2	64.7	-	-	5	-	4-1546307-2
△5 2	57.2	64.7	-	-	5	-	4-1546307-1
△5 2	57.2	64.7	-	-	5	-	4-1546307-0
△5 4	57.2	64.7	-	-	5	-	3-1546307-9
	57.2	64.7	-	-	5	-	1546307-5
△5 2 1	47.7	55.2	-	-	4	-	3-1546307-2
	47.7	55.2	-	-	4	-	1546307-4
△5 2	38.2	45.7	-	-	3	-	3-1546307-8
△5 2	38.2	45.7	-	-	3	-	3-1546307-7
△5 2	38.2	45.7	-	-	3	-	3-1546307-6
△5 2	38.2	45.7	-	-	3	-	3-1546307-5
△5 4	38.2	45.7	-	-	3	-	3-1546307-4
	38.2	45.7	-	-	3	-	1546307-3
	28.7	36.2	-	-	2	-	1546307-2
	DIM B	DIM A	QC TAB .187 45° (2)	QC TAB .187 FLAT (1)	NO OF POSN		PART NUMBER

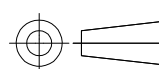
THIS DRAWING IS A CONTROLLED DOCUMENT.		DWN S SCHLEGEL 20AUG2002	 TE Connectivity				
		CHK C RICHARD 8/20/02					
		APVD C RICHARD 8/20/02					
		PRODUCT SPEC					
DIMENSIONS: mm		TOLERANCES UNLESS OTHERWISE SPECIFIED:		NAME 9.50MM (.374) DBL ROW BARRIER STRIP W/ WASHER			
		0 PLC ± - 1 PLC ± 0.3 2 PLC ± 0.25 3 PLC ± - 4 PLC ± - ANGLES ± 2°		APPLICATION SPEC			
MATERIAL -		FINISH -		SIZE A3	CAGE CODE 00779	DRAWING NO C-1546307	RESTRICTED TO -
CUSTOMER DRAWING				SCALE 1:1	SHEET 1 OF 3	REV D9	

THIS DRAWING IS UNPUBLISHED. RELEASED FOR PUBLICATION
 © COPYRIGHT - By - ALL RIGHTS RESERVED.

LOC	DIST	REVISIONS					
		P	LTR	DESCRIPTION	DATE	DWN	APVD
-	-	-	-	SEE SHEET 1	-	-	-



3-1546307-1



3-1546307-5



3-1546307-2

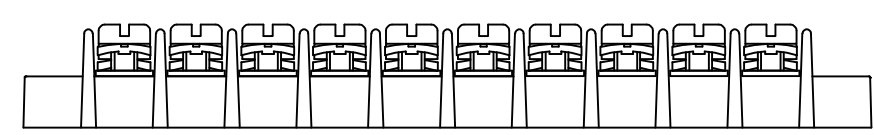
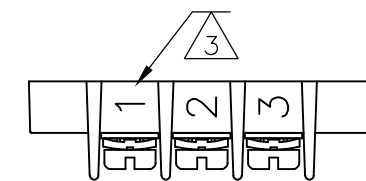
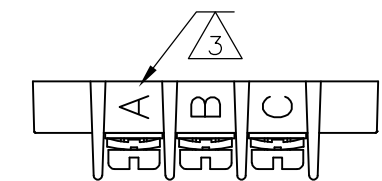

3-1546307-3



3-1546307-7



3-1546307-8



3-1546307-6



294.7	302.2	-	-	30	3-1546307-0
285.2	292.7	-	-	29	2-1546307-9
275.7	283.2	-	-	28	2-1546307-8
266.2	273.7	-	-	27	2-1546307-7
256.7	264.2	-	-	26	2-1546307-6
247.2	254.7	-	-	25	2-1546307-5
237.7	245.2	-	-	24	2-1546307-4
228.2	235.7	-	-	23	2-1546307-3
218.7	226.2	-	-	22	2-1546307-2
209.2	216.7	-	-	21	2-1546307-1
199.7	207.2	-	-	20	3-1546307-1
199.7	207.2	-	-	20	2-1546307-0
190.2	197.7	-	-	19	1-1546307-9
180.7	188.2	-	-	18	1-1546307-8
171.2	178.7	-	-	17	1-1546307-7
161.7	169.2	-	-	16	1-1546307-6
152.2	159.7	-	-	15	1-1546307-5
142.7	150.2	-	-	14	1-1546307-4
133.2	140.7	-	-	13	1-1546307-3
123.7	131.2	-	-	12	1-1546307-2
114.2	121.7	-	-	11	1-1546307-1
DIM B	DIM A	QC TAB .187 45° ②	QC TAB .187 FLAT ①	NO OF POSN	PART NUMBER

THIS DRAWING IS A CONTROLLED DOCUMENT.		DWN S SCHLEGEL 20AUG2002	TE Connectivity		
DIMENSIONS: mm		CHK C RICHARD 8/20/02			
TOLERANCES UNLESS OTHERWISE SPECIFIED:		APVD C RICHARD 8/20/02	NAME 9.50MM (.374) DBL ROW BARRIER STRIP W/ WASHER		
0 PLC ± - 1 PLC ± 0.3 2 PLC ± 0.25 3 PLC ± - 4 PLC ± - ANGLES ± 2°		PRODUCT SPEC -	APPLICATION SPEC -		
MATERIAL -		WEIGHT -	SIZE A3	CAGE CODE 00779	DRAWING NO C-1546307
FINISH -		CUSTOMER DRAWING		SCALE 1:1	SHEET 2 OF 3
				RESTRICTED TO -	REV D9

THIS DRAWING IS UNPUBLISHED.

RELEASED FOR PUBLICATION

ALL RIGHTS RESERVED.

© COPYRIGHT - By -

LOC - -

DIST - -

REVISIONS

P LTR

DESCRIPTION

DATE

DWN

APVD

SEE SHEET 1

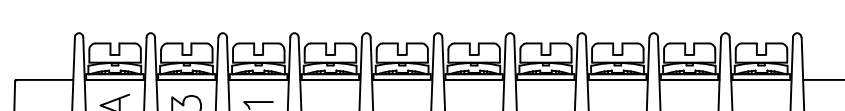
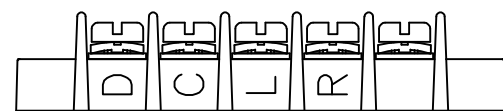
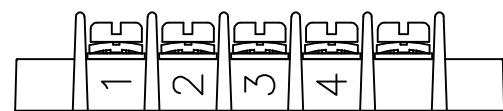
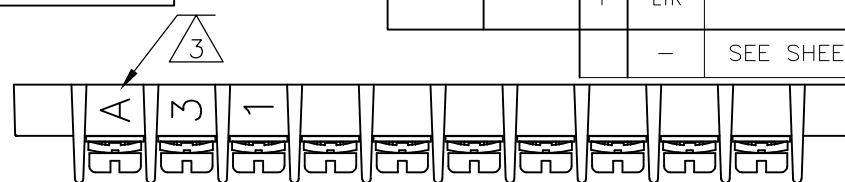
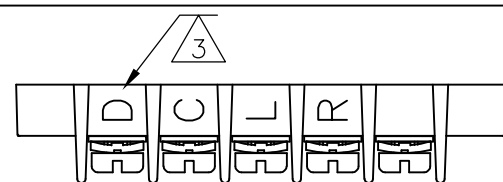
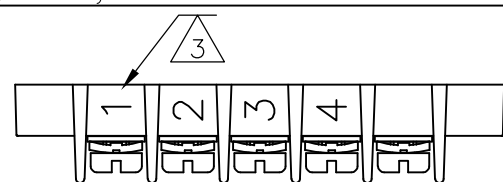

4-1546307-2

4-1546307-3

4-1546307-7

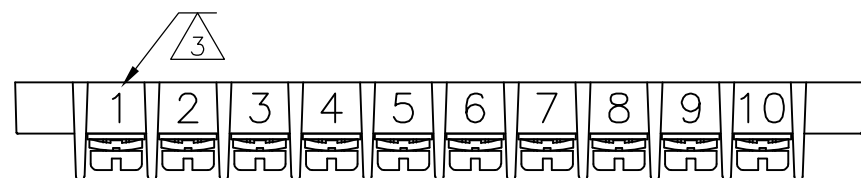

4-1546307-6

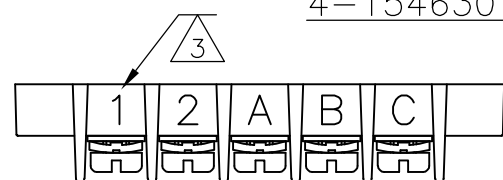

4-1546307-0

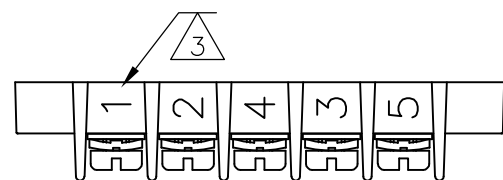

4-1546307-1

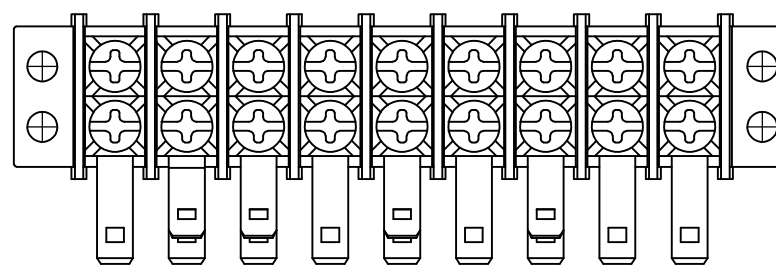

4-1546307-8

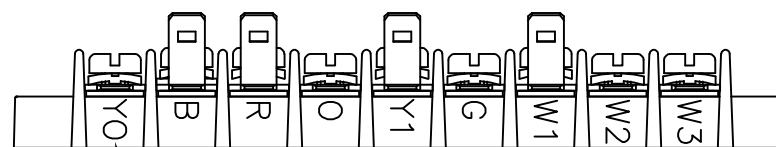

MARK BOTH SIDES

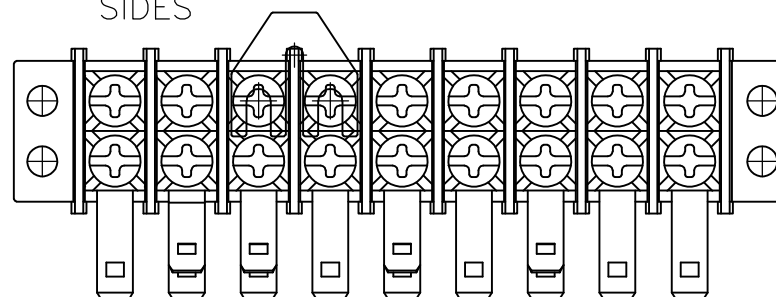

4-1546307-9

MARK BOTH SIDES

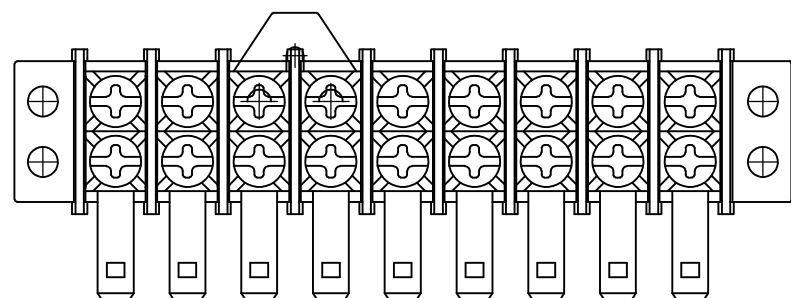
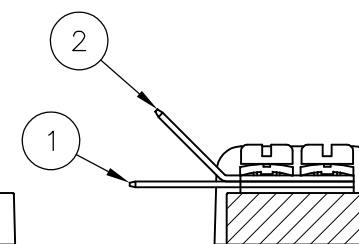
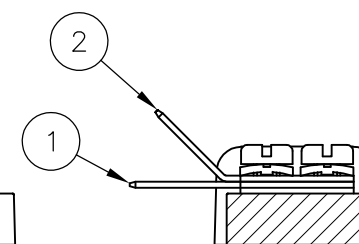

5-1546307-0

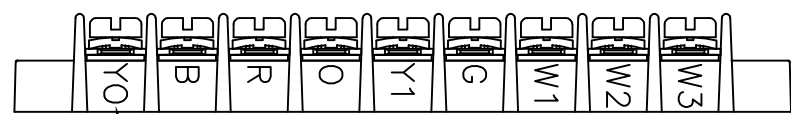

MARK BOTH SIDES

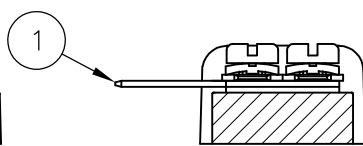

THIS DRAWING IS A CONTROLLED DOCUMENT.

DWN S SCHLEGEL 20AUG2002

CHK C RICHARD 8/20/02

APVD C RICHARD 8/20/02

PRODUCT SPEC

APPLICATION SPEC

WEIGHT -

CUSTOMER DRAWING

STE TE Connectivity

9.50MM (.374) DBL ROW BARRIER STRIP W/ WASHER

SIZE A3 CAGE CODE 00779 DRAWING NO C-1546307 RESTRICTED TO -

SCALE 1:1 SHEET 3 OF 3 REV D9

DIMENSIONS:

mm

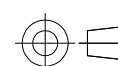

TOLERANCES UNLESS OTHERWISE SPECIFIED:

0 PLC	± -
1 PLC	± 0.3
2 PLC	± 0.25
3 PLC	± -
4 PLC	± -
ANGLES	± 2'
FINISH	-

MATERIAL -



Компания «ЭлектроПласт» предлагает заключение долгосрочных отношений при поставках импортных электронных компонентов на взаимовыгодных условиях!

Наши преимущества:

- Оперативные поставки широкого спектра электронных компонентов отечественного и импортного производства напрямую от производителей и с крупнейших мировых складов;
- Поставка более 17-ти миллионов наименований электронных компонентов;
- Поставка сложных, дефицитных, либо снятых с производства позиций;
- Оперативные сроки поставки под заказ (от 5 рабочих дней);
- Экспресс доставка в любую точку России;
- Техническая поддержка проекта, помощь в подборе аналогов, поставка прототипов;
- Система менеджмента качества сертифицирована по Международному стандарту ISO 9001;
- Лицензия ФСБ на осуществление работ с использованием сведений, составляющих государственную тайну;
- Поставка специализированных компонентов (Xilinx, Altera, Analog Devices, Intersil, Interpoint, Microsemi, Aeroflex, Peregrine, Syfer, Eurofarad, Texas Instrument, Miteq, Cobham, E2V, MA-COM, Hittite, Mini-Circuits, General Dynamics и др.);

Помимо этого, одним из направлений компании «ЭлектроПласт» является направление «Источники питания». Мы предлагаем Вам помощь Конструкторского отдела:

- Подбор оптимального решения, техническое обоснование при выборе компонента;
- Подбор аналогов;
- Консультации по применению компонента;
- Поставка образцов и прототипов;
- Техническая поддержка проекта;
- Защита от снятия компонента с производства.



Как с нами связаться

Телефон: 8 (812) 309 58 32 (многоканальный)

Факс: 8 (812) 320-02-42

Электронная почта: org@eplast1.ru

Адрес: 198099, г. Санкт-Петербург, ул. Калинина, дом 2, корпус 4, литера А.