

THIS DRAWING IS UNPUBLISHED. RELEASED FOR PUBLICATION
 © COPYRIGHT - By - ALL RIGHTS RESERVED.

LOC		DIST		REVISIONS			
P	LTR	DESCRIPTION		DATE	DWN	APVD	
	D9	REVISED PER ECO-12-012202		03JUL12	KH	MS	

PHYSICAL PROPERTIES:
 HOUSING MATERIAL: PBT
 FLAMMABILITY: UL94V-0
 COLOR: BLACK

TERMINAL:
 TERMINALS: BRASS, TIN PLATED
 SCREWS: 6-32, STEEL, NICKEL PLATED

MECHANICAL:
 PITCH (TERMINAL SPACING): 9.50mm (.374")
 WIRE RANGE: 12-22 AWG
 RECOMMENDED TIGHTENING TORQUE: 12IN-LBS MAX.

ELECTRICAL PROPERTIES:
 MAXIMUM CURRENT: 20A
 OPERATING VOLTAGE: 300V

ENVIRONMENTAL PROPERTIES:
 OPERATING TEMP RANGE: -40°C TO 120°C

- ① SCREWS ON ONE SIDE IN WIRE READY POSITION.
- ② SEE FIGURE.
- ③ WHITE INK STAMP.
- ④ NICKEL PLATED BRASS SCREWS.
- ⑤ PRELIMINARY PART NUMBER.
- ⑥ TE CONNECTIVITY LOGO LOCATED APPROXIMATE AREA SHOWN.

LOC	DIST	P	LTR	DESCRIPTION	DATE	DWN	APVD
5/2				104.7 112.2 - - 10 4-1546307-7			
5/2				104.7 112.2 - - 10 4-1546307-6			
5/4				104.7 112.2 - - 10 4-1546307-5			
5/2/1				104.7 112.2 - - 10 3-1546307-3			
				104.7 112.2 - - 10 1-1546307-0			
5/3/2/1				95.2 102.7 - 9 9 5-1546307-0			
5/3/2/1				95.2 102.7 4 9 9 4-1546307-9			
3/2/1				95.2 102.7 4 9 9 4-1546307-8			
				95.2 102.7 - - 9 1546307-9			
				85.7 93.2 - - 8 1546307-8			
				76.2 83.7 - - 7 1546307-7			
5/4				66.7 74.2 - - 6 4-1546307-4			
				66.7 74.2 - - 6 1546307-6			
5/2				57.2 64.7 - - 5 4-1546307-3			
5/2				57.2 64.7 - - 5 4-1546307-2			
5/2				57.2 64.7 - - 5 4-1546307-1			
5/2				57.2 64.7 - - 5 4-1546307-0			
5/4				57.2 64.7 - - 5 3-1546307-9			
				57.2 64.7 - - 5 1546307-5			
5/2/1				47.7 55.2 - - 4 3-1546307-2			
				47.7 55.2 - - 4 1546307-4			
5/2				38.2 45.7 - - 3 3-1546307-8			
5/2				38.2 45.7 - - 3 3-1546307-7			
5/2				38.2 45.7 - - 3 3-1546307-6			
5/2				38.2 45.7 - - 3 3-1546307-5			
5/4				38.2 45.7 - - 3 3-1546307-4			
				38.2 45.7 - - 3 1546307-3			
				28.7 36.2 - - 2 1546307-2			
	DIM B	DIM A	QC TAB .187 45° ②	QC TAB .187 FLAT ①	NO OF POSN	PART NUMBER	

THIS DRAWING IS A CONTROLLED DOCUMENT.		DWN S SCHLEGEL 20AUG2002	 TE Connectivity				
DIMENSIONS: mm		CHK C RICHARD 8/20/02					
TOLERANCES UNLESS OTHERWISE SPECIFIED:		APVD C RICHARD 8/20/02	NAME 9.50MM (.374) DBL ROW BARRIER STRIP W/ WASHER				
0 PLC ± - 1 PLC ± 0.3 2 PLC ± 0.25 3 PLC ± - 4 PLC ± - ANGLES ± 2'		PRODUCT SPEC -	APPLICATION SPEC -				
MATERIAL -		FINISH -	WEIGHT -	SIZE A3	CAGE CODE 00779	DRAWING NO C-1546307	RESTRICTED TO -
CUSTOMER DRAWING			SCALE 1:1	SHEET 1 OF 3	REV D9		

THIS DRAWING IS UNPUBLISHED. RELEASED FOR PUBLICATION
 © COPYRIGHT - By - ALL RIGHTS RESERVED.

LOC	DIST	REVISIONS					
		P	LTR	DESCRIPTION	DATE	DWN	APVD
-	-	-	-	SEE SHEET 1	-	-	-



3-1546307-1



3-1546307-5



3-1546307-2

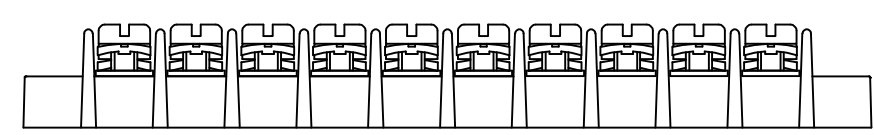
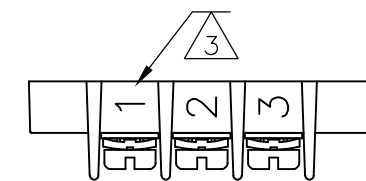
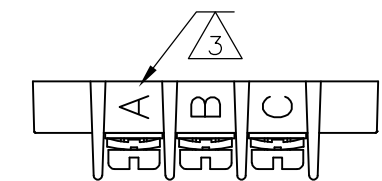

3-1546307-3



3-1546307-7



3-1546307-8



3-1546307-6

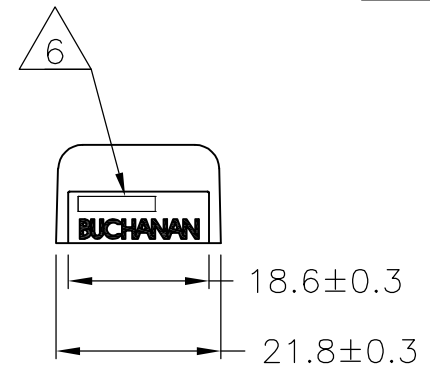

294.7	302.2	-	-	30	3-1546307-0
285.2	292.7	-	-	29	2-1546307-9
275.7	283.2	-	-	28	2-1546307-8
266.2	273.7	-	-	27	2-1546307-7
256.7	264.2	-	-	26	2-1546307-6
247.2	254.7	-	-	25	2-1546307-5
237.7	245.2	-	-	24	2-1546307-4
228.2	235.7	-	-	23	2-1546307-3
218.7	226.2	-	-	22	2-1546307-2
209.2	216.7	-	-	21	2-1546307-1
199.7	207.2	-	-	20	3-1546307-1
199.7	207.2	-	-	20	2-1546307-0
190.2	197.7	-	-	19	1-1546307-9
180.7	188.2	-	-	18	1-1546307-8
171.2	178.7	-	-	17	1-1546307-7
161.7	169.2	-	-	16	1-1546307-6
152.2	159.7	-	-	15	1-1546307-5
142.7	150.2	-	-	14	1-1546307-4
133.2	140.7	-	-	13	1-1546307-3
123.7	131.2	-	-	12	1-1546307-2
114.2	121.7	-	-	11	1-1546307-1
DIM B	DIM A	QC TAB .187 45° ②	QC TAB .187 FLAT ①	NO OF POSN	PART NUMBER

THIS DRAWING IS A CONTROLLED DOCUMENT.

DIMENSIONS: mm	TOLERANCES UNLESS OTHERWISE SPECIFIED:	DWN S SCHLEGEL 20AUG2002	TE Connectivity 9.50MM (.374) DBL ROW BARRIER STRIP W/ WASHER
	0 PLC ± -	CHK C RICHARD 8/20/02	
	1 PLC ± 0.3	APVD C RICHARD 8/20/02	
MATERIAL -	2 PLC ± 0.25	PRODUCT SPEC -	
	3 PLC ± -	APPLICATION SPEC -	SIZE CAGE CODE DRAWING NO RESTRICTED TO
	4 PLC ± -	WEIGHT -	A3 00779 C-1546307
	ANGLES ± 2'	CUSTOMER DRAWING	SCALE 1:1 SHEET 2 OF 3 REV D9
	FINISH -		

THIS DRAWING IS UNPUBLISHED.

RELEASED FOR PUBLICATION

ALL RIGHTS RESERVED.

© COPYRIGHT - By -

LOC -

DIST -

P

LTR

REVISIONS

DESCRIPTION

DATE

DWN

APVD

SEE SHEET 1

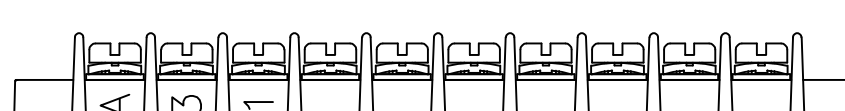
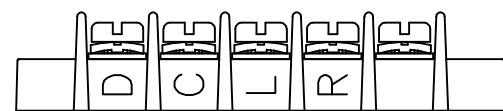
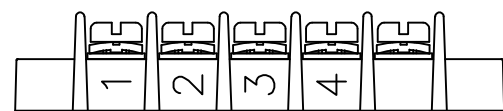
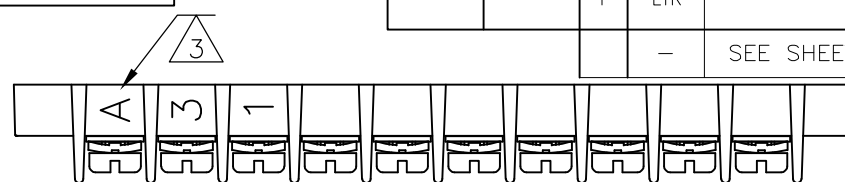
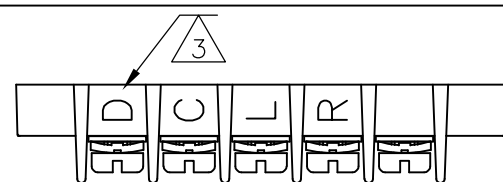
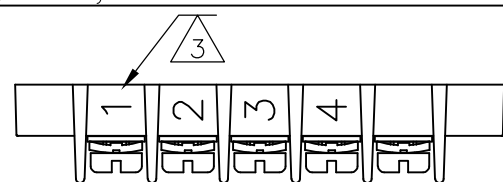

4-1546307-2

4-1546307-3

4-1546307-7

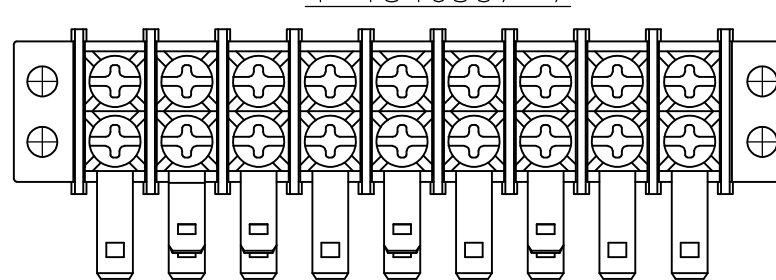
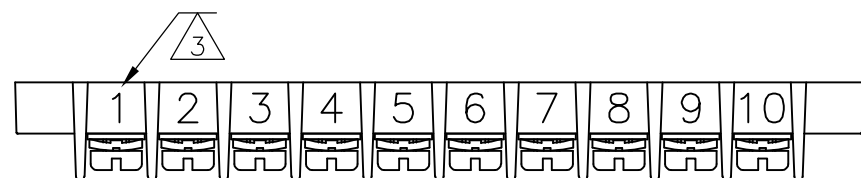

4-1546307-6

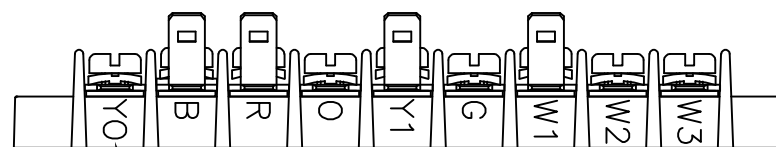
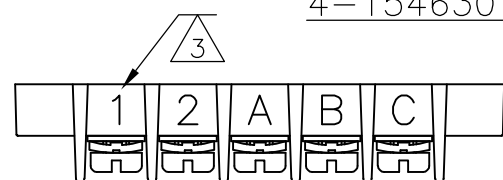

4-1546307-0

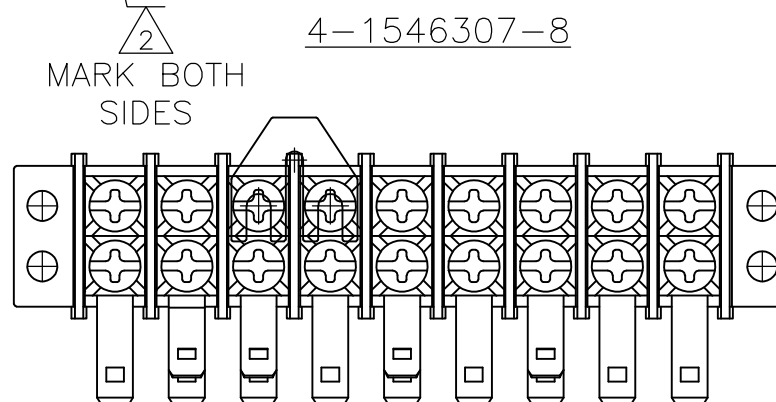
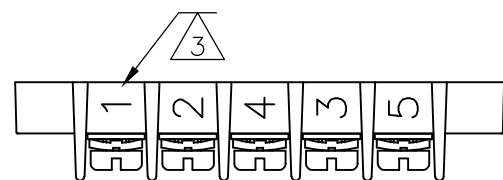

4-1546307-1

MARK BOTH SIDES

4-1546307-8

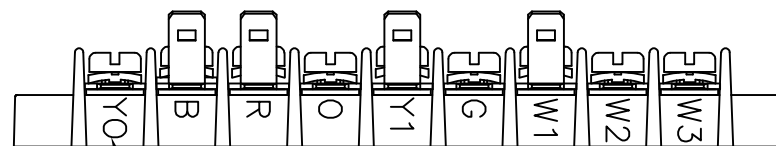

4-1546307-1

MARK BOTH SIDES

4-1546307-9

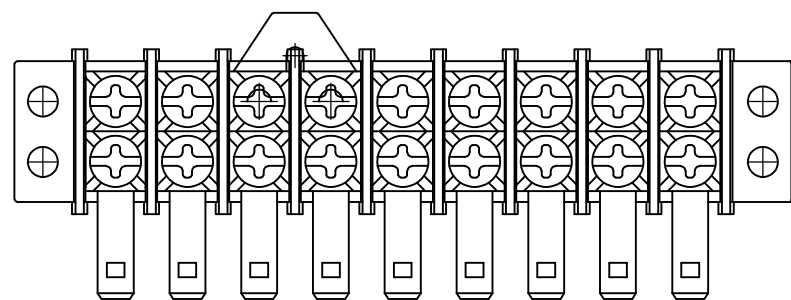

5-1546307-0

MARK BOTH SIDES

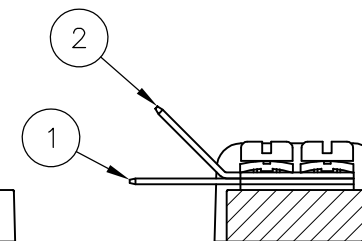
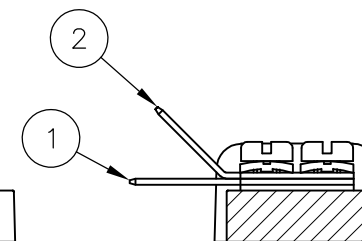
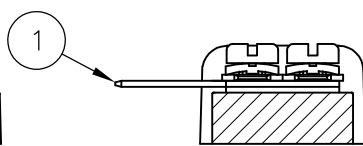

THIS DRAWING IS A CONTROLLED DOCUMENT.

DWN 20AUG2002

S SCHLEGEL

CHK 8/20/02

C RICHARD

APVD 8/20/02

C RICHARD

PRODUCT SPEC

APPLICATION SPEC

WEIGHT

CUSTOMER DRAWING

STE TE Connectivity

9.50MM (.374) DBL ROW BARRIER STRIP W/ WASHER

SIZE A3 CAGE CODE 00779 DRAWING NO C-1546307 RESTRICTED TO

SCALE 1:1 SHEET 3 OF 3 REV D9

DIMENSIONS:

mm

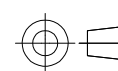

TOLERANCES UNLESS OTHERWISE SPECIFIED:

- 0 PLC ± -
- 1 PLC ± 0.3
- 2 PLC ± 0.25
- 3 PLC ± -
- 4 PLC ± -
- ANGLES ± 2'
- FINISH -

MATERIAL



Компания «ЭлектроПласт» предлагает заключение долгосрочных отношений при поставках импортных электронных компонентов на взаимовыгодных условиях!

Наши преимущества:

- Оперативные поставки широкого спектра электронных компонентов отечественного и импортного производства напрямую от производителей и с крупнейших мировых складов;
- Поставка более 17-ти миллионов наименований электронных компонентов;
- Поставка сложных, дефицитных, либо снятых с производства позиций;
- Оперативные сроки поставки под заказ (от 5 рабочих дней);
- Экспресс доставка в любую точку России;
- Техническая поддержка проекта, помощь в подборе аналогов, поставка прототипов;
- Система менеджмента качества сертифицирована по Международному стандарту ISO 9001;
- Лицензия ФСБ на осуществление работ с использованием сведений, составляющих государственную тайну;
- Поставка специализированных компонентов (Xilinx, Altera, Analog Devices, Intersil, Interpoint, Microsemi, Aeroflex, Peregrine, Syfer, Eurofarad, Texas Instrument, Miteq, Cobham, E2V, MA-COM, Hittite, Mini-Circuits, General Dynamics и др.);

Помимо этого, одним из направлений компании «ЭлектроПласт» является направление «Источники питания». Мы предлагаем Вам помощь Конструкторского отдела:

- Подбор оптимального решения, техническое обоснование при выборе компонента;
- Подбор аналогов;
- Консультации по применению компонента;
- Поставка образцов и прототипов;
- Техническая поддержка проекта;
- Защита от снятия компонента с производства.



Как с нами связаться

Телефон: 8 (812) 309 58 32 (многоканальный)

Факс: 8 (812) 320-02-42

Электронная почта: org@eplast1.ru

Адрес: 198099, г. Санкт-Петербург, ул. Калинина, дом 2, корпус 4, литера А.