

FEATURES

High speed

- 1.5 GHz, -3 dB bandwidth ($G = +1$)
- 650 MHz, full power bandwidth ($G = +2, V_o = 2$ V p-p)
- Slew rate: 4100 V/ μ s
- 0.1% settling time: 12 ns

Excellent video specifications

- 0.1 dB flatness: 170 MHz
- Differential gain: 0.02%
- Differential phase: 0.01°

Output overdrive recovery: 22 ns

Low noise: 1.6 nV/ $\sqrt{\text{Hz}}$ input voltage noise

Low distortion over wide bandwidth

- 75 dBc SFDR @ 20 MHz
- 62 dBc SFDR @ 50 MHz

Input offset voltage: 1 mV typ

High output current: 100 mA

Wide supply voltage range: 4.5 V to 12 V

Supply current: 13.5 mA

Power-down mode

APPLICATIONS

Professional video

High speed instrumentation

Video switching

IF/RF gain stage

CCD imaging

GENERAL DESCRIPTION

The AD8000 is an ultrahigh speed, high performance, current feedback amplifier. Using ADI's proprietary eXtra Fast Complementary Bipolar (XFCB) process, the amplifier can achieve a small signal bandwidth of 1.5 GHz and a slew rate of 4100 V/ μ s.

The AD8000 has low spurious-free dynamic range (SFDR) of 75 dBc @ 20 MHz and input voltage noise of 1.6 nV/ $\sqrt{\text{Hz}}$. The AD8000 can drive over 100 mA of load current with minimal distortion. The amplifier can operate on +5 V to ± 6 V. These specifications make the AD8000 ideal for a variety of applications, including high speed instrumentation.

With a differential gain of 0.02%, differential phase of 0.01°, and 0.1 dB flatness out to 170 MHz, the AD8000 has excellent video specifications, which ensure that even the most demanding video systems maintain excellent fidelity.

Rev. B

Document Feedback

Information furnished by Analog Devices is believed to be accurate and reliable. However, no responsibility is assumed by Analog Devices for its use, nor for any infringements of patents or other rights of third parties that may result from its use. Specifications subject to change without notice. No license is granted by implication or otherwise under any patent or patent rights of Analog Devices. Trademarks and registered trademarks are the property of their respective owners.

CONNECTION DIAGRAMS

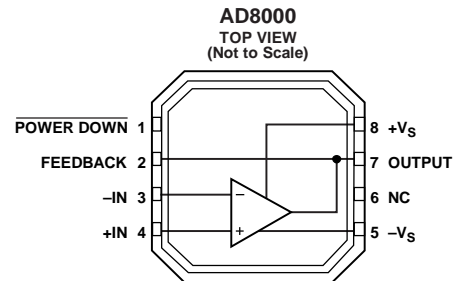

- NOTES
1. NC = NO CONNECT.
2. THE EXPOSED PADDLE IS CONNECTED TO GROUND.

Figure 1. 8-Lead AD8000, 3 mm \times 3 mm LFCSP_VD (CP-8-2)

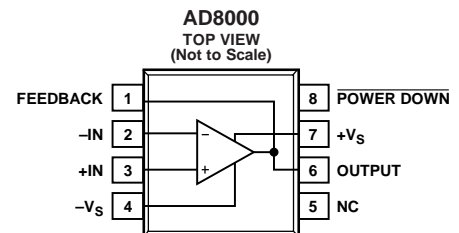

- NOTES
1. NC = NO CONNECT.
2. THE EXPOSED PADDLE IS CONNECTED TO GROUND.

Figure 2. 8-Lead AD8000 SOIC_N_EP (RD-8-1)

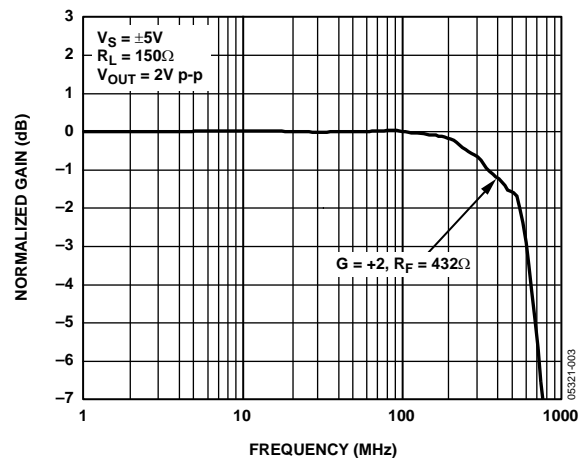

Figure 3. Large Signal Frequency Response

The AD8000 power-down mode reduces the supply current to 1.3 mA. The amplifier is available in a tiny 8-lead LFCSP package, as well as in an 8-lead SOIC package. The AD8000 is rated to work over the extended industrial temperature range (-40°C to $+125^{\circ}\text{C}$). A triple version of the AD8000 (AD8003) is under-development.

TABLE OF CONTENTS

| | | | |
|--|----|------------------------------------|----|
| Table of Contents | 2 | Video Line Driver..... | 14 |
| Specifications with ± 5 V Supply | 3 | Low Distortion Pinout | 15 |
| Specifications with +5 V Supply | 4 | Exposed Paddle..... | 15 |
| Absolute Maximum Ratings..... | 5 | Printed Circuit Board Layout | 15 |
| Thermal Resistance | 5 | Signal Routing..... | 15 |
| ESD Caution..... | 5 | Power Supply Bypassing | 15 |
| Typical Performance Characteristics | 6 | Grounding | 16 |
| Test Circuits..... | 13 | Outline Dimensions | 17 |
| Applications..... | 14 | Ordering Guide | 17 |
| Circuit Configurations..... | 14 | | |

REVISION HISTORY

3/13—Rev. A to Rev. B

| | |
|--|----|
| Changes to Figure 1 and Figure 2 | 1 |
| Change to Table 1 | 3 |
| Changes to Table 2..... | 4 |
| Updated Outline Dimensions | 17 |
| Changes to Ordering Guide | 17 |

3/10—Rev. 0 to Rev. A

| | |
|--|----|
| Changes to Figure 1 and Figure 2 | 1 |
| Changes to Table 3..... | 5 |
| Updated Outline Dimensions and Changes to Ordering Guide..... | 17 |

1/05—Rev. 0: Initial Version

SPECIFICATIONS WITH ± 5 V SUPPLY

At $T_A = 25^\circ\text{C}$, $V_S = \pm 5$ V, $R_L = 150\ \Omega$, Gain = +2, $R_F = R_G = 432\ \Omega$, unless otherwise noted. Exposed paddle should be connected to ground.

Table 1.

| Parameter | Conditions | Min | Typ | Max | Unit |
|-----------------------------------|---|-----------|-------------------------|------|------------------------------|
| DYNAMIC PERFORMANCE | | | | | |
| -3 dB Bandwidth | $G = +1$, $V_O = 0.2$ V p-p, SOIC/LFCSP | | 1580/1350 | | MHz |
| | $G = +2$, $V_O = 2$ V p-p, SOIC/LFCSP | | 650/610 | | MHz |
| Bandwidth for 0.1 dB Flatness | $V_O = 2$ V p-p, SOIC/LFCSP | | 190/170 | | MHz |
| Slew Rate | $G = +2$, $V_O = 4$ V step | | 4100 | | V/ μs |
| Settling Time to 0.1% | $G = +2$, $V_O = 2$ V step | | 12 | | ns |
| NOISE/HARMONIC PERFORMANCE | | | | | |
| Second/Third Harmonic | $V_O = 2$ V p-p, $f = 5$ MHz, LFCSP only | | 86/89 | | dBc |
| Second/Third Harmonic | $V_O = 2$ V p-p, $f = 20$ MHz, LFCSP only | | 75/79 | | dBc |
| Input Voltage Noise | $f = 100$ kHz | | 1.6 | | nV/ $\sqrt{\text{Hz}}$ |
| Input Current Noise | $f = 100$ kHz, -IN | | 26 | | pA/ $\sqrt{\text{Hz}}$ |
| | $f = 100$ kHz, +IN | | 3.4 | | pA/ $\sqrt{\text{Hz}}$ |
| Differential Gain Error | NTSC, $G = +2$ | | 0.02 | | % |
| Differential Phase Error | NTSC, $G = +2$ | | 0.01 | | Degree |
| DC PERFORMANCE | | | | | |
| Input Offset Voltage | | | 1 | 10 | mV |
| Input Offset Voltage Drift | | | 11 | | $\mu\text{V}/^\circ\text{C}$ |
| Input Bias Current (Enabled) | +I _B | | -5 | +4 | μA |
| | -I _B | | -3 | +45 | μA |
| Transimpedance | | 570 | 890 | 1600 | k Ω |
| INPUT CHARACTERISTICS | | | | | |
| Noninverting Input Impedance | | | 2/3.6 | | M Ω /pF |
| Input Common-Mode Voltage Range | | | -3.5 to +3.5 | | V |
| Common-Mode Rejection Ratio | $V_{CM} = \pm 2.5$ V | -52 | -54 | -56 | dB |
| Overdrive Recovery | $G = +1$, $f = 1$ MHz, triangle wave | | 30 | | ns |
| POWER DOWN PIN | | | | | |
| Power-Down Input Voltage | Power-down | | < +V _S - 3.1 | | V |
| | Enabled | | > +V _S - 1.9 | | V |
| Turn-Off Time | 50% of power-down voltage to 10% of V _{OUT} final, V _{IN} = 0.3 V p-p | | 150 | | ns |
| Turn-On Time | 50% of power-down voltage to 90% of V _{OUT} final, V _{IN} = 0.3 V p-p | | 300 | | ns |
| Input Bias Current | | | | | |
| Enabled | | -1.1 | +0.17 | +1.4 | μA |
| Power-Down | | -300 | -235 | -160 | μA |
| OUTPUT CHARACTERISTICS | | | | | |
| Output Voltage Swing | $R_L = 100\ \Omega$ | ± 3.7 | ± 3.9 | | V |
| Output Voltage Swing | $R_L = 1\ \text{k}\Omega$ | ± 3.9 | ± 4.1 | | V |
| Linear Output Current | $V_O = 2$ V p-p, second HD < -50 dBc | | 100 | | mA |
| Overdrive Recovery | $G = +2$, $f = 1$ MHz, triangle wave | | 45 | | ns |
| | $G = +2$, V _{IN} = 2.5 V to 0 V step | | 22 | | ns |
| POWER SUPPLY | | | | | |
| Operating Range | | 4.5 | | 12 | V |
| Quiescent Current | | 12.7 | 13.5 | 14.3 | mA |
| Quiescent Current (Power-Down) | | 1.1 | 1.3 | 1.65 | mA |
| Power Supply Rejection Ratio | -PSRR/+PSRR | -56/-61 | -59/-63 | | dB |

SPECIFICATIONS WITH +5 V SUPPLY

At $T_A = 25^\circ\text{C}$, $V_S = +5\text{ V}$, $R_L = 150\ \Omega$, $\text{Gain} = +2$, $R_F = R_G = 432\ \Omega$, unless otherwise noted. Exposed paddle should be connected to ground.

Table 2.

| Parameter | Conditions | Min | Typ | Max | Unit |
|-----------------------------------|---|------------|-------------------------|------|------------------------------|
| DYNAMIC PERFORMANCE | | | | | |
| –3 dB Bandwidth | $G = +1, V_o = 0.2\text{ V p-p}$ | | 980 | | MHz |
| | $G = +2, V_o = 2\text{ V p-p}$ | | 477 | | MHz |
| | $G = +10, V_o = 0.2\text{ V p-p}$ | | 328 | | MHz |
| Bandwidth for 0.1 dB Flatness | $V_o = 0.2\text{ V p-p}$ | | 136 | | MHz |
| | $V_o = 2\text{ V p-p}$ | | 136 | | MHz |
| Slew Rate | $G = +2, V_o = 2\text{ V step}$ | | 2700 | | V/ μs |
| Settling Time to 0.1% | $G = +2, V_o = 2\text{ V step}$ | | 16 | | ns |
| NOISE/HARMONIC PERFORMANCE | | | | | |
| Second/Third Harmonic | $V_o = 2\text{ V p-p}$, 5 MHz, LFCSP only | | 71/71 | | dBc |
| Second/Third Harmonic | $V_o = 2\text{ V p-p}$, 20 MHz, LFCSP only | | 60/62 | | dBc |
| Input Voltage Noise | $f = 100\text{ kHz}$ | | 1.6 | | nV/ $\sqrt{\text{Hz}}$ |
| Input Current Noise | $f = 100\text{ kHz}$, –IN | | 26 | | pA/ $\sqrt{\text{Hz}}$ |
| | $f = 100\text{ kHz}$, +IN | | 3.4 | | pA/ $\sqrt{\text{Hz}}$ |
| Differential Gain Error | NTSC, $G = +2$ | | 0.01 | | % |
| Differential Phase Error | NTSC, $G = +2$ | | 0.06 | | Degree |
| DC PERFORMANCE | | | | | |
| Input Offset Voltage | | | 1.3 | 10 | mV |
| Input Offset Voltage Drift | | | 18 | | $\mu\text{V}/^\circ\text{C}$ |
| Input Bias Current (Enabled) | +I _B | | –5 | +3 | μA |
| | –I _B | | –1 | +45 | μA |
| Transimpedance | | 440 | 800 | 1500 | k Ω |
| INPUT CHARACTERISTICS | | | | | |
| Noninverting Input Impedance | | | 2/3.6 | | M Ω /pF |
| Input Common-Mode Voltage Range | | | 1.5 to 3.6 | | V |
| Common-Mode Rejection Ratio | $V_{CM} = \pm 2.5\text{ V}$ | –51 | –52 | –54 | dB |
| Overdrive Recovery | $G = +1, f = 1\text{ MHz}$, triangle wave | | 60 | | ns |
| POWER DOWN PIN | | | | | |
| Power-Down Input Voltage | Power-down | | < +V _S – 3.1 | | V |
| | Enable | | > +V _S – 1.9 | | V |
| Turn-Off Time | 50% of power-down voltage to 10% of V _{OUT} final, V _{IN} = 0.3 V p-p | | 200 | | ns |
| Turn-On Time | 50% of power-down voltage to 90% of V _{OUT} final, V _{IN} = 0.3 V p-p | | 300 | | ns |
| Input Current | Enabled | –1.1 | +0.17 | +1.4 | μA |
| | Power-Down | –50 | –40 | –30 | μA |
| OUTPUT CHARACTERISTICS | | | | | |
| Output Voltage Swing | $R_L = 100\ \Omega$ | 1.1 to 3.9 | 1.05 to 4.1 | | V |
| | $R_L = 1\ \text{k}\Omega$ | 1 to 4.0 | 0.85 to 4.15 | | V |
| Linear Output Current | $V_o = 2\text{ V p-p}$, second HD < –50 dBc | | 70 | | mA |
| Overdrive Recovery | $G = +2, f = 100\text{ kHz}$, triangle wave | | 65 | | ns |
| POWER SUPPLY | | | | | |
| Operating Range | | 4.5 | | 12 | V |
| Quiescent Current | | 11 | 12 | 13 | mA |
| Quiescent Current (Power-Down) | | 0.7 | 0.95 | 1.25 | mA |
| Power Supply Rejection Ratio | –PSRR/+PSRR | –55/–60 | –57/–62 | | dB |

ABSOLUTE MAXIMUM RATINGS

Table 3.

| Parameter | Rating |
|---|--|
| Supply Voltage | 12.6 V |
| Power Dissipation | See Figure 4 |
| Common-Mode Input Voltage | $-V_S - 0.7\text{ V}$ to $+V_S + 0.7\text{ V}$ |
| Differential Input Voltage | $\pm V_S$ |
| Storage Temperature | -65°C to $+125^\circ\text{C}$ |
| Operating Temperature Range | -40°C to $+125^\circ\text{C}$ |
| Lead Temperature Range (Soldering, 10 sec) | 300°C |
| Junction Temperature | 150°C |

Stresses above those listed under Absolute Maximum Ratings may cause permanent damage to the device. This is a stress rating only; functional operation of the device at these or any other conditions above those indicated in the operational section of this specification is not implied. Exposure to absolute maximum rating conditions for extended periods may affect device reliability.

THERMAL RESISTANCE

θ_{JA} is specified for the worst-case conditions, that is, θ_{JA} is specified for device soldered in the circuit board for surface-mount packages.

Table 4. Thermal Resistance

| Package Type | θ_{JA} | θ_{JC} | Unit |
|--------------------------|---------------|---------------|---------------------------|
| SOIC-8 | 80 | 30 | $^\circ\text{C}/\text{W}$ |
| 3 mm \times 3 mm LFCSP | 93 | 35 | $^\circ\text{C}/\text{W}$ |

Maximum Power Dissipation

The maximum safe power dissipation for the AD8000 is limited by the associated rise in junction temperature (T_J) on the die. At approximately 150°C , which is the glass transition temperature, the properties of the plastic change. Even temporarily exceeding this temperature limit can change the stresses that the package exerts on the die, permanently shifting the parametric performance of the AD8000. Exceeding a junction temperature of 175°C for an extended period of time can result in changes in silicon devices, potentially causing degradation or loss of functionality.

ESD CAUTION

ESD (electrostatic discharge) sensitive device. Electrostatic charges as high as 4000 V readily accumulate on the human body and test equipment and can discharge without detection. Although this product features proprietary ESD protection circuitry, permanent damage may occur on devices subjected to high energy electrostatic discharges. Therefore, proper ESD precautions are recommended to avoid performance degradation and loss of functionality.

The power dissipated in the package (P_D) is the sum of the quiescent power dissipation and the power dissipated in the die due to the AD8000 drive at the output. The quiescent power is the voltage between the supply pins (V_S) times the quiescent current (I_S).

$$P_D = \text{Quiescent Power} + (\text{Total Drive Power} - \text{Load Power})$$

$$P_D = (V_S \times I_S) + \left(\frac{V_S}{2} \times \frac{V_{OUT}}{R_L} \right) - \frac{V_{OUT}^2}{R_L}$$

RMS output voltages should be considered. If R_L is referenced to $-V_S$, as in single-supply operation, the total drive power is $V_S \times I_{OUT}$. If the rms signal levels are indeterminate, consider the worst case, when $V_{OUT} = V_S/4$ for R_L to midsupply.

$$P_D = (V_S \times I_S) + \frac{(V_S/4)^2}{R_L}$$

In single-supply operation with R_L referenced to $-V_S$, worst case is $V_{OUT} = V_S/2$.

Airflow increases heat dissipation, effectively reducing θ_{JA} . Also, more metal directly in contact with the package leads and exposed paddle from metal traces, through holes, ground, and power planes reduces θ_{JA} .

Figure 4 shows the maximum safe power dissipation in the package vs. the ambient temperature for the exposed paddle SOIC ($80^\circ\text{C}/\text{W}$) and the LFCSP ($93^\circ\text{C}/\text{W}$) package on a JEDEC standard 4-layer board. θ_{JA} values are approximations.

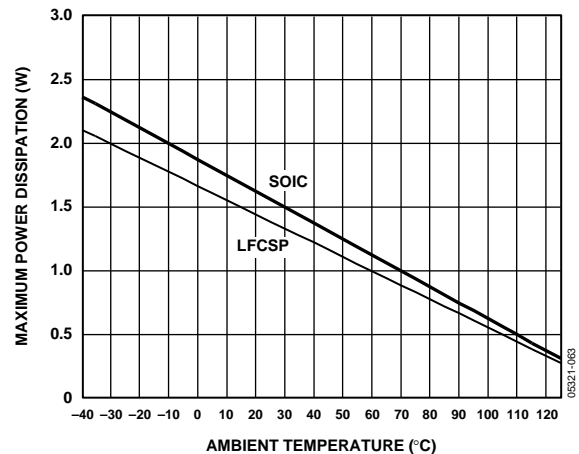

Figure 4. Maximum Power Dissipation vs. Temperature for a 4-Layer Board



TYPICAL PERFORMANCE CHARACTERISTICS

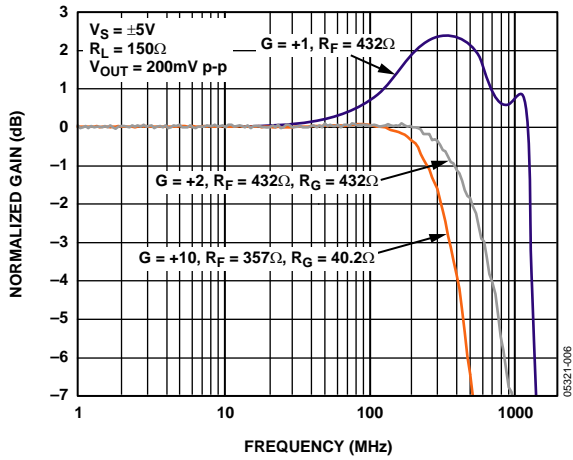

Figure 5. Small Signal Frequency Response vs. Various Gains

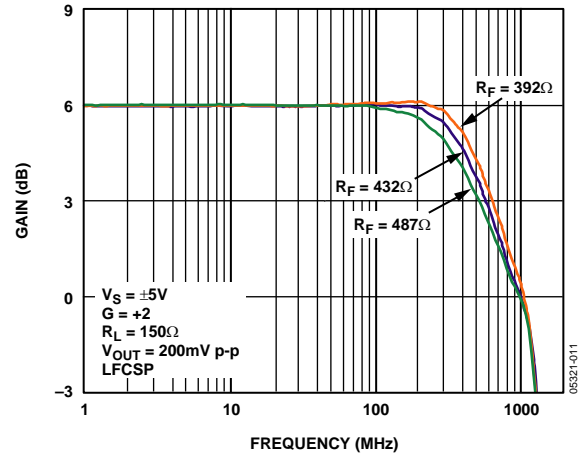

Figure 8. Small Signal Frequency Response vs. R_F

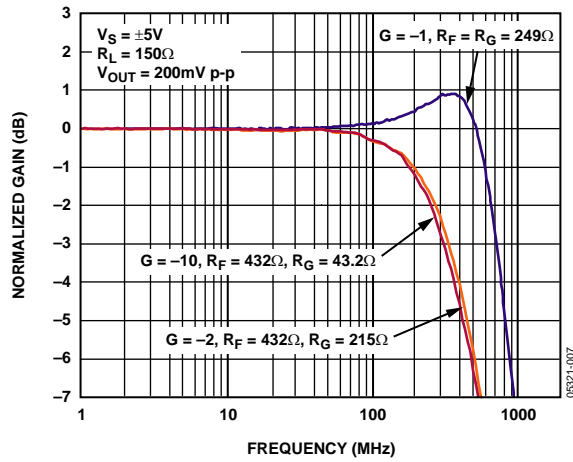

Figure 6. Small Signal Frequency Response vs. Various Gains

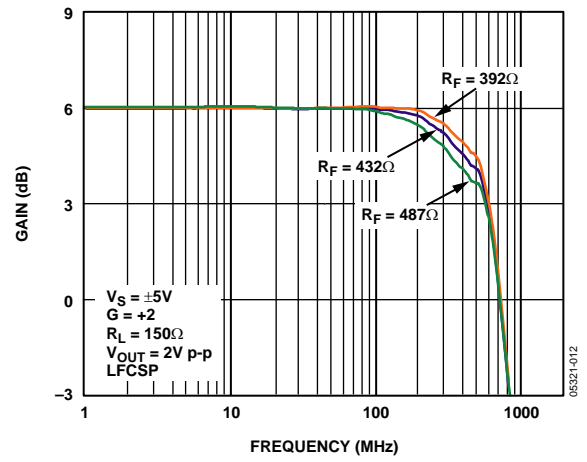

Figure 9. Large Signal Frequency Response vs. R_F

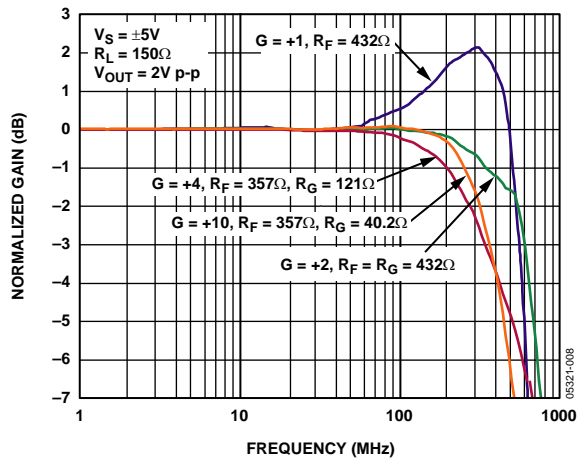

Figure 7. Large Signal Frequency Response vs. Various Gains

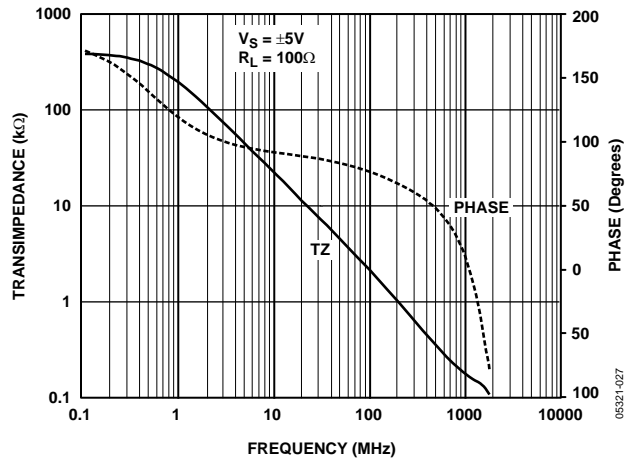

Figure 10. Transimpedance and Phase vs. Frequency

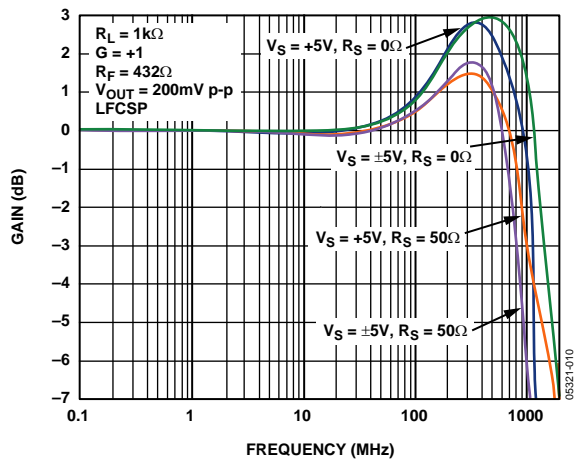

Figure 11. Small Signal Frequency Response vs. Supply Voltage



Figure 14. Small Signal Frequency Response vs. Temperature

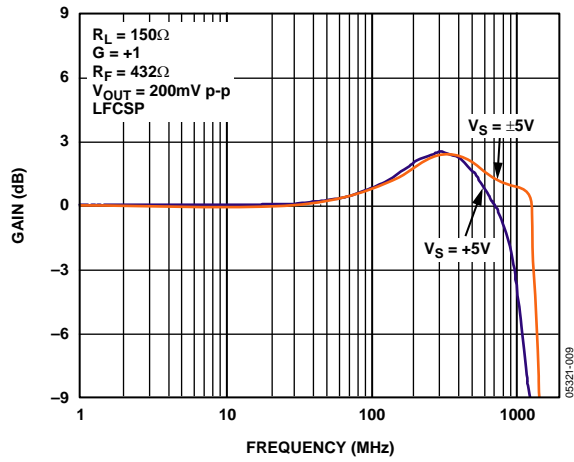

Figure 12. Small Signal Frequency Response vs. Supply Voltage

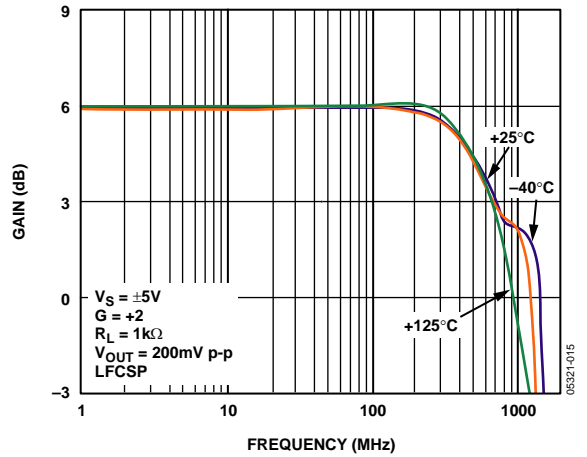

Figure 15. Small Signal Frequency Response vs. Temperature

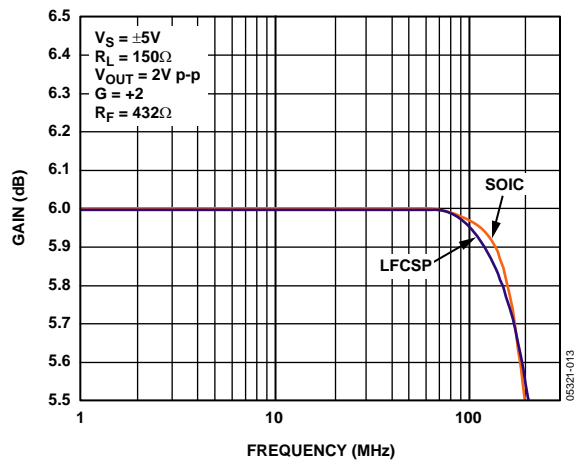

Figure 13. 0.1 dB Flatness

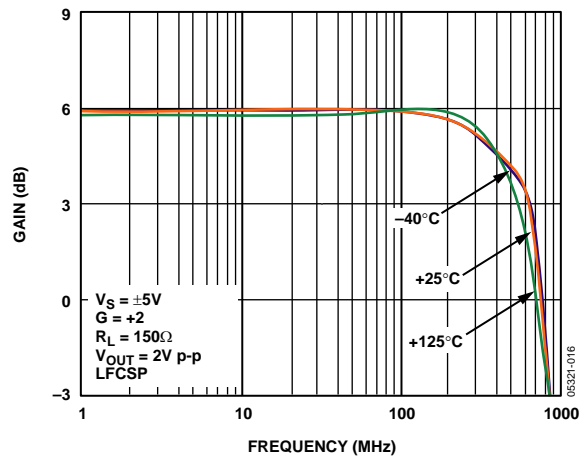

Figure 16. Large Signal Frequency Response vs. Temperature

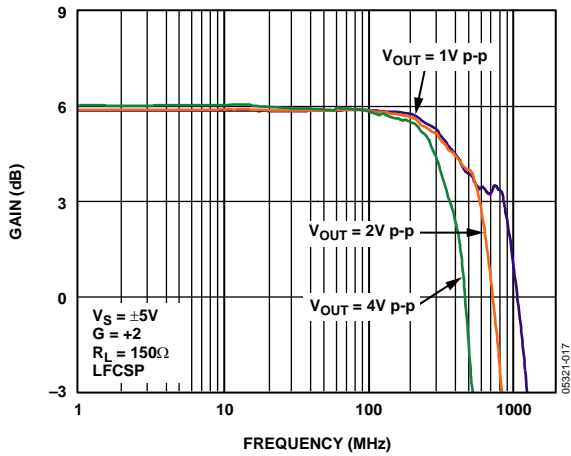

Figure 17. Large Signal Frequency Response vs. Various Outputs

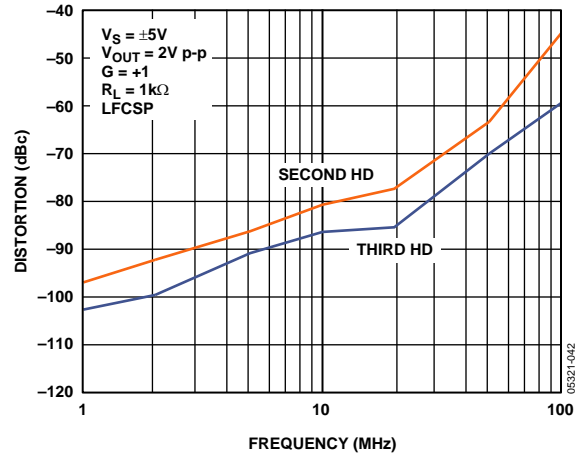

Figure 20. Harmonic Distortion vs. Frequency

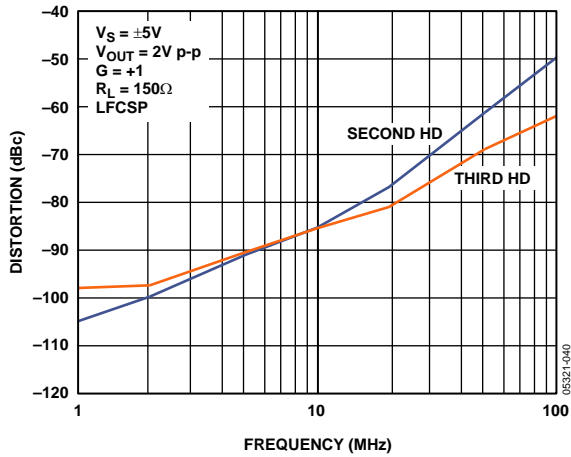

Figure 18. Harmonic Distortion vs. Frequency

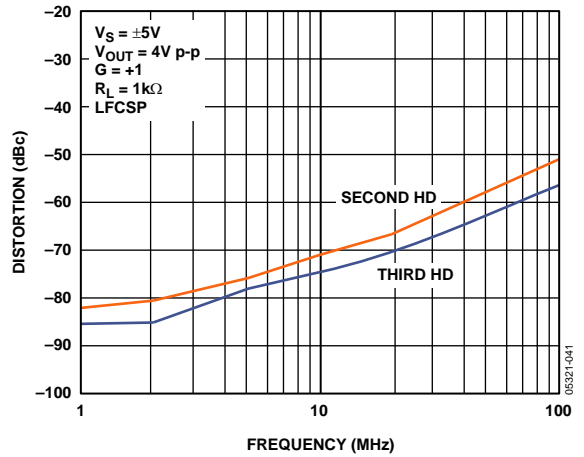

Figure 21. Harmonic Distortion vs. Frequency

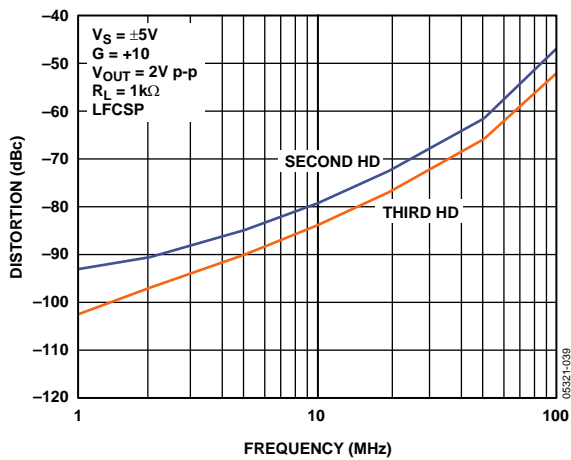

Figure 19. Harmonic Distortion vs. Frequency



Figure 22. Harmonic Distortion vs. Frequency

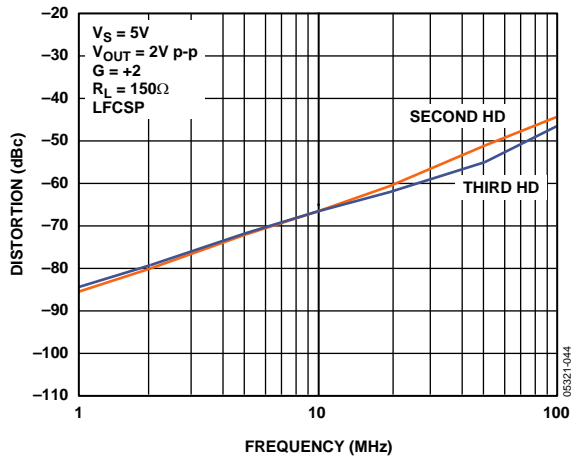

Figure 23. Harmonic Distortion vs. Frequency

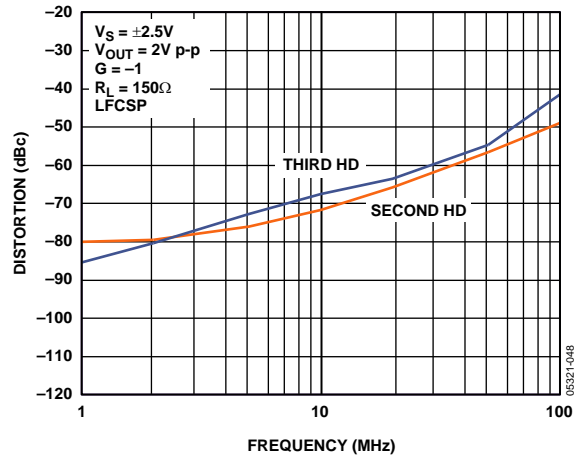

Figure 26. Harmonic Distortion vs. Frequency

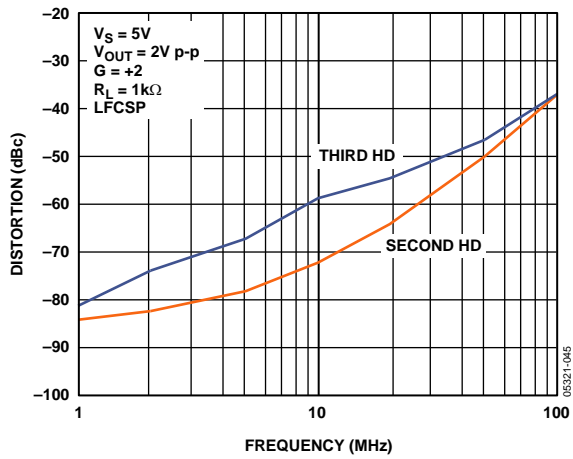

Figure 24. Harmonic Distortion vs. Frequency

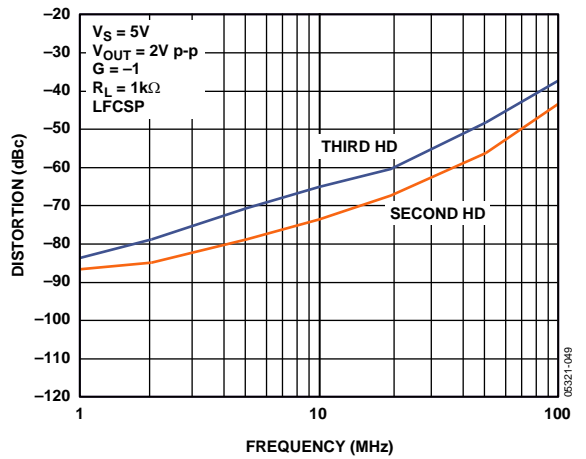

Figure 27. Harmonic Distortion vs. Frequency

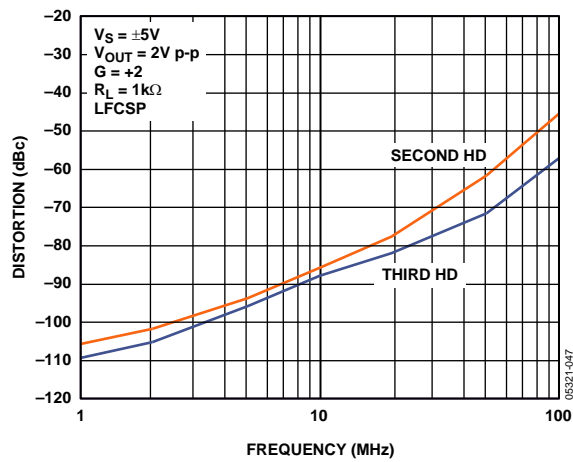

Figure 25. Harmonic Distortion vs. Frequency

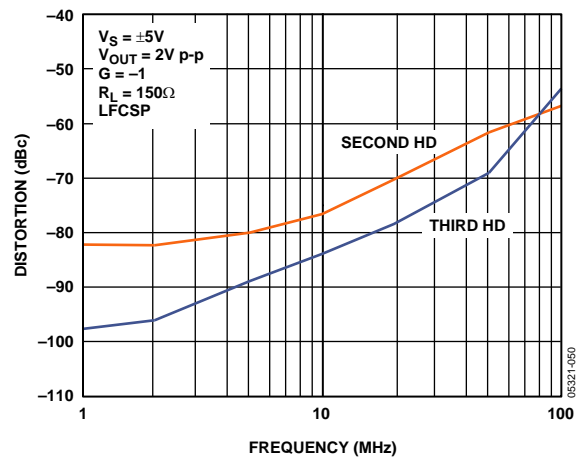

Figure 28. Harmonic Distortion vs. Frequency

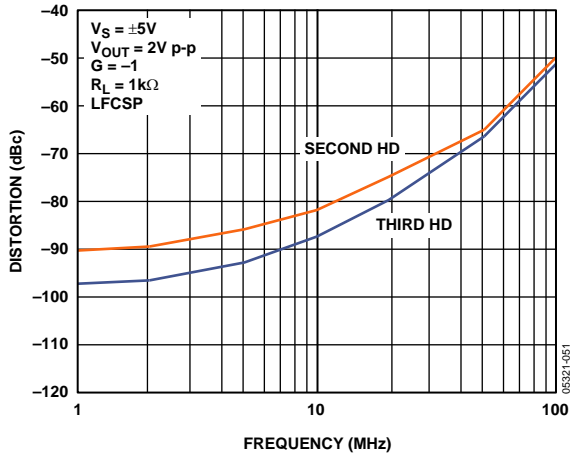

Figure 29. Harmonic Distortion vs. Frequency

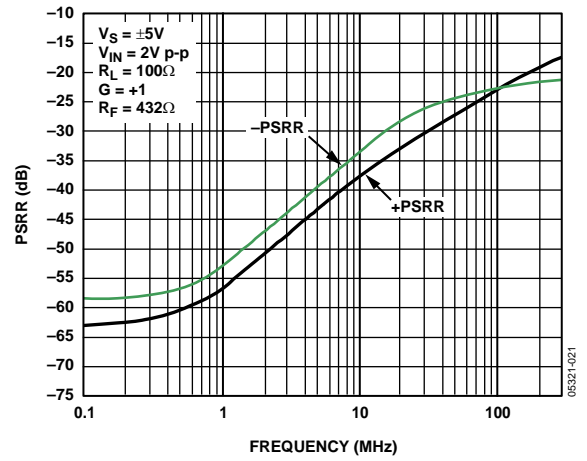

Figure 32. Power Supply Rejection Ratio (PSRR) vs. Frequency

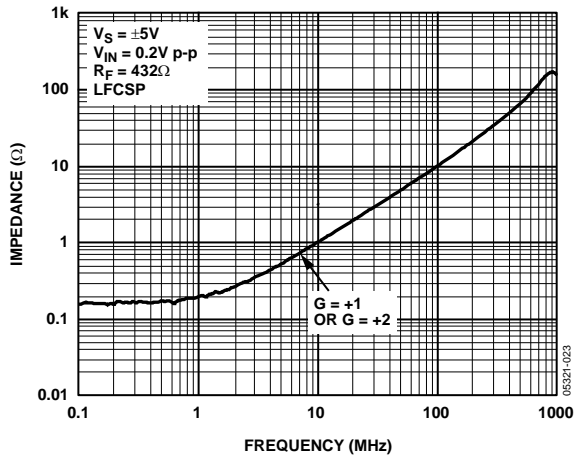

Figure 30. Output Impedance vs. Frequency

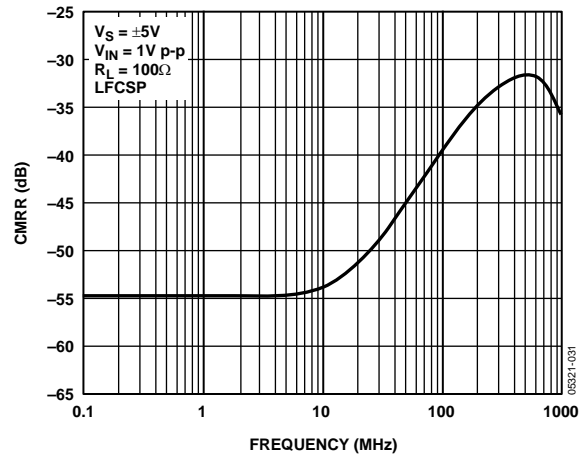

Figure 33. Common-Mode Rejection Ratio vs. Frequency

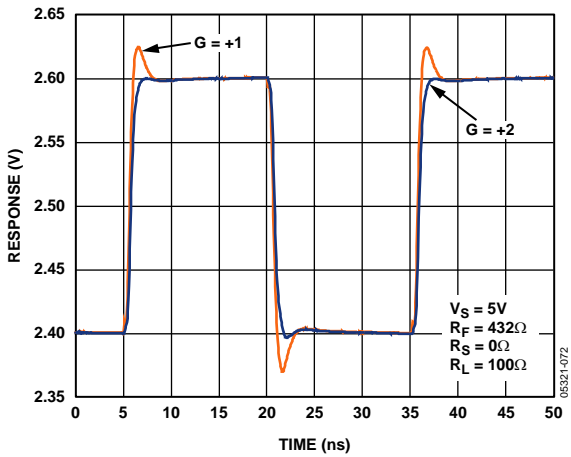

Figure 31. Small Signal Transient Response

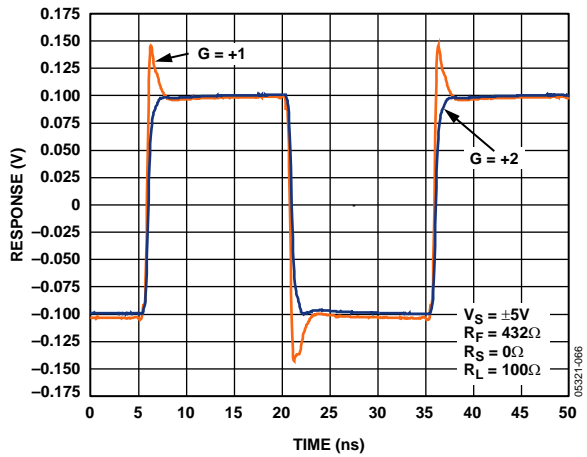

Figure 34. Small Signal Transient Response



Figure 35. Large Signal Transient Response



Figure 38. Input Overdrive

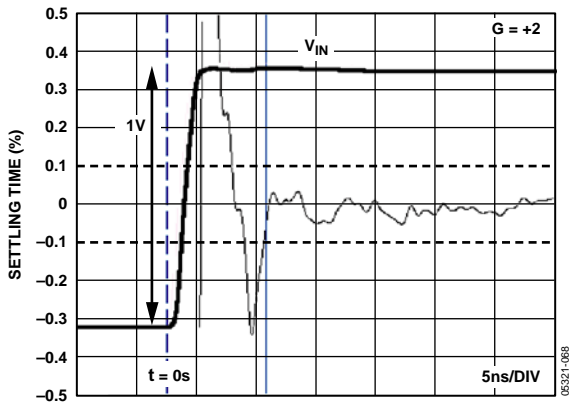

Figure 36. Settling Time

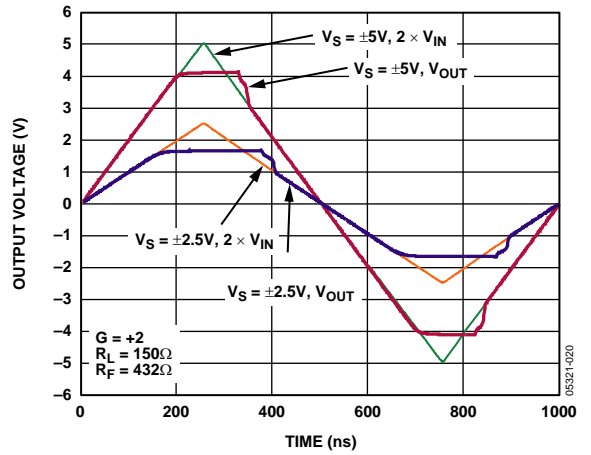

Figure 39. Output Overdrive

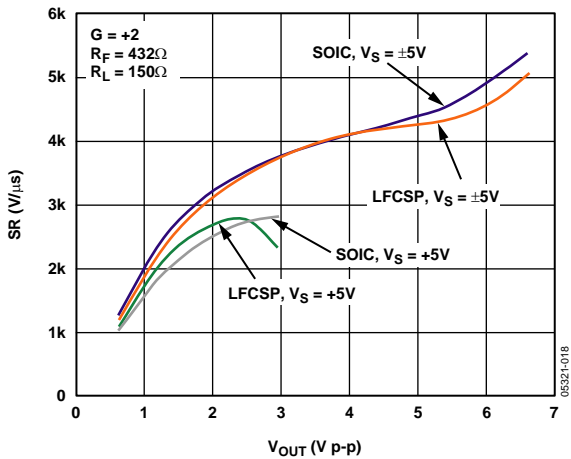

Figure 37. Slew Rate vs. Output Level



Figure 40. Input Voltage Noise



Figure 41. Input Current Noise



Figure 44. Input Bias Current vs. Common-Mode Voltage

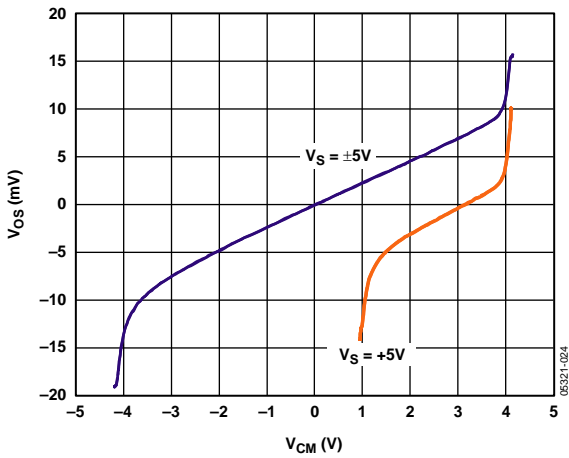

Figure 42. Input V_{OS} vs. Common-Mode Voltage

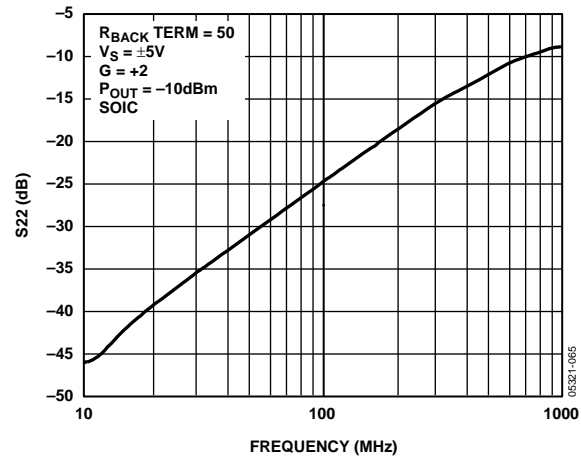

Figure 45. Output Voltage Standing Wave Ratio (S22)



Figure 43. Input Bias Current vs. Output Voltage



Figure 46. Input Voltage Standing Wave Ratio (S11)

TEST CIRCUITS

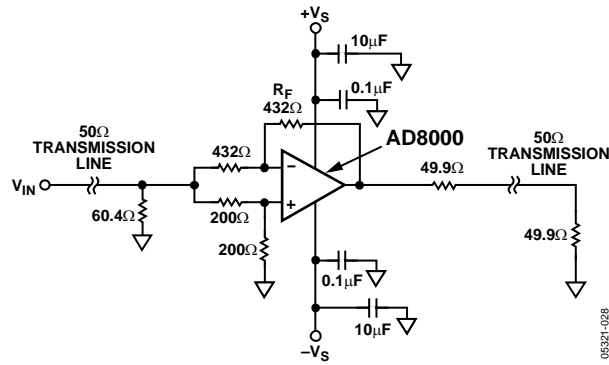

Figure 47. CMRR



Figure 48. Positive PSRR

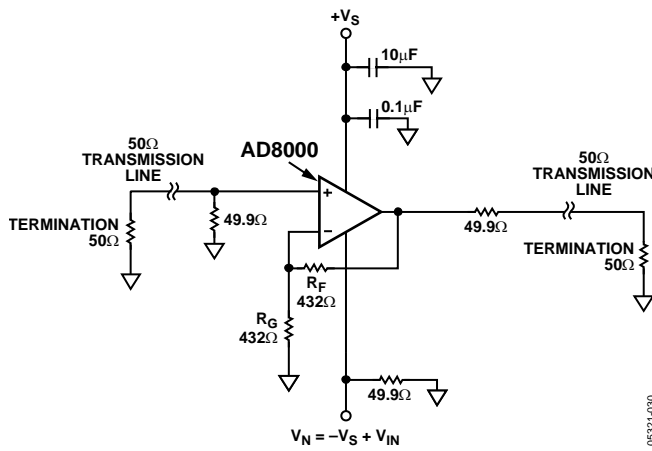

Figure 49. Negative PSRR

APPLICATIONS

All current feedback amplifier operational amplifiers are affected by stray capacitance at the inverting input pin. As a practical consideration, the higher the stray capacitance on the inverting input to ground, the higher R_F needs to be to minimize peaking and ringing.

CIRCUIT CONFIGURATIONS

Figure 50 and Figure 51 show typical schematics for non-inverting and inverting configurations. For current feedback amplifiers, the value of feedback resistance determines the stability and bandwidth of the amplifier. The optimum performance values are shown in Table 5 and should not be deviated from by more than $\pm 10\%$ to ensure stable operation. Figure 8 shows the influence varying R_F has on bandwidth. In noninverting unity-gain configurations, it is recommended that an R_S of $50\ \Omega$ be used, as shown in Figure 50.

Table 5 provides a quick reference for the circuit values, gain, and output voltage noise.



Figure 50. Noninverting Configuration



Figure 51. Inverting Configuration

VIDEO LINE DRIVER

The AD8000 is designed to offer outstanding performance as a video line driver. The important specifications of differential gain (0.02%), differential phase (0.01°), and 650 MHz bandwidth at 2 V p-p meet the most exacting video demands. Figure 52 shows a typical noninverting video driver with a gain of +2.

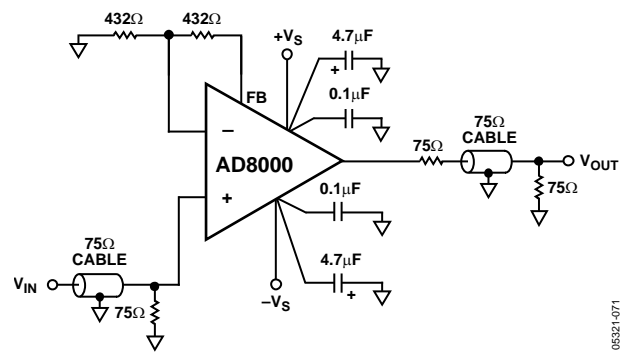

Figure 52. Video Line Driver

Table 5. Typical Values (LFCSP/SOIC)

| Gain | Component Values (Ω) | | -3 dB SS Bandwidth (MHz) | | -3 dB LS Bandwidth (MHz) | | Slew Rate (V/ μ sec) | Output Noise (nV/ \sqrt Hz) | Total Output Noise Including Resistors (nV/ \sqrt Hz) |
|------|-------------------------------|-------|--------------------------|------|--------------------------|------|--------------------------|-------------------------------|---|
| | R_F | R_G | LFCSP | SOIC | LFCSP | SOIC | | | |
| 1 | 432 | --- | 1380 | 1580 | 550 | 600 | 2200 | 10.9 | 11.2 |
| 2 | 432 | 432 | 600 | 650 | 610 | 650 | 3700 | 11.3 | 11.9 |
| 4 | 357 | 120 | 550 | 550 | 350 | 350 | 3800 | 10 | 12 |
| 10 | 357 | 40 | 350 | 365 | 370 | 370 | 3200 | 18.4 | 19.9 |

LOW DISTORTION PINOUT

The AD8000 LFCSP features ADI's new low distortion pinout. The new pinout lowers the second harmonic distortion and simplifies the circuit layout. The close proximity of the non-inverting input and the negative supply pin creates a source of second harmonic distortion. Physical separation of the non-inverting input pin and the negative power supply pin reduces this distortion significantly, as seen in Figure 22.

By providing an additional output pin, the feedback resistor can be connected directly across Pin 2 and Pin 3. This greatly simplifies the routing of the feedback resistor and allows a more compact circuit layout, which reduces its size and helps to minimize parasitics and increase stability.

The SOIC also features a dedicated feedback pin. The feedback pin is brought out on Pin 1, which is typically a No Connect on standard SOIC pinouts.

Existing applications that use the standard SOIC pinout can take full advantage of the performance offered by the AD8000. For drop-in replacements, ensure that Pin 1 is not connected to ground or to any other potential because this pin is connected internally to the output of the amplifier. For existing designs, Pin 6 can still be used for the feedback resistor.

EXPOSED PADDLE

The AD8000 features an exposed paddle, which can lower the thermal resistance by 25% compared to a standard SOIC plastic package. The paddle can be soldered directly to the ground plane of the board. Figure 53 shows a typical pad geometry for the LFCSP, the same type of pad geometry can be applied to the SOIC package.

Thermal vias or "heat pipes" can also be incorporated into the design of the mounting pad for the exposed paddle. These additional vias improve the thermal transfer from the package to the PCB. Using a heavier weight copper on the surface to which the amplifier's exposed paddle is soldered also reduces the overall thermal resistance "seen" by the AD8000.

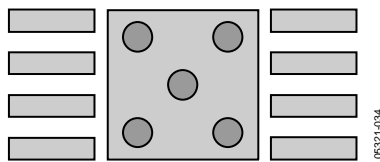

Figure 53. LFCSP Exposed Paddle Layout

06321-034

PRINTED CIRCUIT BOARD LAYOUT

Laying out the printed circuit board (PCB) is usually the last step in the design process and often proves to be one of the most critical. A brilliant design can be rendered useless because of a poor or sloppy layout. Since the AD8000 can operate into the R_f frequency spectrum, high frequency board layout considerations must be taken into account. The PCB layout, signal routing, power supply bypassing, and grounding all must be addressed to ensure optimal performance.

SIGNAL ROUTING

The AD8000 LFCSP features the new low distortion pinout with a dedicated feedback pin and allows a compact layout. The dedicated feedback pin reduces the distance from the output to the inverting input, which greatly simplifies the routing of the feedback network.

To minimize parasitic inductances, ground planes should be used under high frequency signal traces. However, the ground plane should be removed from under the input and output pins to minimize the formation of parasitic capacitors, which degrades phase margin. Signals that are susceptible to noise pickup should be run on the internal layers of the PCB, which can provide maximum shielding.

POWER SUPPLY BYPASSING

Power supply bypassing is a critical aspect of the PCB design process. For best performance, the AD8000 power supply pins need to be properly bypassed.

A parallel connection of capacitors from each of the power supply pins to ground works best. Paralleling different values and sizes of capacitors helps to ensure that the power supply pins "see" a low ac impedance across a wide band of frequencies. This is important for minimizing the coupling of noise into the amplifier. Starting directly at the power supply pins, the smallest value and sized component should be placed on the same side of the board as the amplifier, and as close as possible to the amplifier, and connected to the ground plane. This process should be repeated for the next larger value capacitor. It is recommended for the AD8000 that a 0.1 μF ceramic 0508 case be used. The 0508 offers low series inductance and excellent high frequency performance. The 0.1 μF case provides low impedance at high frequencies. A 10 μF electrolytic capacitor should be placed in parallel with the 0.1 μF . The 10 μF capacitor provides low ac impedance at low frequencies. Smaller values of electrolytic capacitors can be used, depending on the circuit requirements. Additional smaller value capacitors help to provide a low impedance path for unwanted noise out to higher frequencies but are not always necessary.

Placement of the capacitor returns (grounds), where the capacitors enter into the ground plane, is also important. Returning the capacitors grounds close to the amplifier load is critical for distortion performance. Keeping the capacitors distance short, but equal from the load, is optimal for performance.

In some cases, bypassing between the two supplies can help to improve PSRR and to maintain distortion performance in crowded or difficult layouts. This is as another option to improve performance.

Minimizing the trace length and widening the trace from the capacitors to the amplifier reduce the trace inductance. A series inductance with the parallel capacitance can form a tank circuit, which can introduce high frequency ringing at the output. This additional inductance can also contribute to increased distortion due to high frequency compression at the output. The use of vias should be minimized in the direct path to the amplifier power supply pins since vias can introduce parasitic inductance, which can lead to instability. When required, use multiple large diameter vias because this lowers the equivalent parasitic inductance.

GROUNDING

The use of ground and power planes is encouraged as a method of providing low impedance returns for power supply and signal currents. Ground and power planes can also help to reduce stray trace inductance and to provide a low thermal path for the amplifier. Ground and power planes should not be used under any of the pins of the AD8000. The mounting pads and the ground or power planes can form a parasitic capacitance at the amplifiers input. Stray capacitance on the inverting input and the feedback resistor form a pole, which degrades the phase margin, leading to instability. Excessive stray capacitance on the output also forms a pole, which degrades phase margin.

OUTLINE DIMENSIONS



COMPLIANT TO JEDEC STANDARDS MS-012-AA
 Figure 54. 8-Lead Standard Small Outline Package, with Exposed Pad [SOIC_N_EP]
 Narrow Body (RD-8-1)
 Dimensions shown in millimeters and (inches)

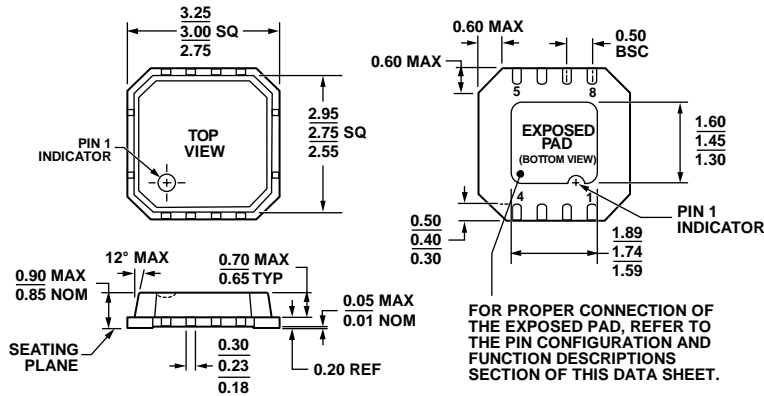

Figure 55. 8-Lead Lead Frame Chip Scale Package [LFCSP_VD]
 3 mm x 3 mm Body, Very Thin, Dual Lead
 (CP-8-2)
 Dimensions shown in millimeters

ORDERING GUIDE

| Model ¹ | Temperature Range | Package Description | Package Option | Branding | Ordering Quantity |
|--------------------|-------------------|---------------------|----------------|----------|-------------------|
| AD8000YRDZ | -40°C to +125°C | 8-Lead SOIC_N_EP | RD-8-1 | | 1 |
| AD8000YRDZ-REEL | -40°C to +125°C | 8-Lead SOIC_N_EP | RD-8-1 | | 2,500 |
| AD8000YRDZ-REEL7 | -40°C to +125°C | 8-Lead SOIC_N_EP | RD-8-1 | | 1,000 |
| AD8000YCPZ-R2 | -40°C to +125°C | 8-Lead LFCSP_VD | CP-8-2 | HNB | 250 |
| AD8000YCPZ-REEL | -40°C to +125°C | 8-Lead LFCSP_VD | CP-8-2 | HNB | 5,000 |
| AD8000YCPZ-REEL7 | -40°C to +125°C | 8-Lead LFCSP_VD | CP-8-2 | HNB | 1,500 |
| AD8000YCPZ-EBZ | | Evaluation Board | | | |
| AD8000YRD-EBZ | | Evaluation Board | | | |

¹ Z = RoHS Compliant Part.

NOTES

NOTES

NOTES



Компания «ЭлектроПласт» предлагает заключение долгосрочных отношений при поставках импортных электронных компонентов на взаимовыгодных условиях!

Наши преимущества:

- Оперативные поставки широкого спектра электронных компонентов отечественного и импортного производства напрямую от производителей и с крупнейших мировых складов;
- Поставка более 17-ти миллионов наименований электронных компонентов;
- Поставка сложных, дефицитных, либо снятых с производства позиций;
- Оперативные сроки поставки под заказ (от 5 рабочих дней);
- Экспресс доставка в любую точку России;
- Техническая поддержка проекта, помощь в подборе аналогов, поставка прототипов;
- Система менеджмента качества сертифицирована по Международному стандарту ISO 9001;
- Лицензия ФСБ на осуществление работ с использованием сведений, составляющих государственную тайну;
- Поставка специализированных компонентов (Xilinx, Altera, Analog Devices, Intersil, Interpoint, Microsemi, Aeroflex, Peregrine, Syfer, Eurofarad, Texas Instrument, Miteq, Cobham, E2V, MA-COM, Hittite, Mini-Circuits, General Dynamics и др.);

Помимо этого, одним из направлений компании «ЭлектроПласт» является направление «Источники питания». Мы предлагаем Вам помощь Конструкторского отдела:

- Подбор оптимального решения, техническое обоснование при выборе компонента;
- Подбор аналогов;
- Консультации по применению компонента;
- Поставка образцов и прототипов;
- Техническая поддержка проекта;
- Защита от снятия компонента с производства.



Как с нами связаться

Телефон: 8 (812) 309 58 32 (многоканальный)

Факс: 8 (812) 320-02-42

Электронная почта: org@eplast1.ru

Адрес: 198099, г. Санкт-Петербург, ул. Калинина, дом 2, корпус 4, литера А.