

SPVQA Water-proof Type

Fork terminals allow connection without solder



Detector

Slide

Push

Rotary

Power

Dual-in-line
Package Type

General-
purpose Type

Water-proof
Type

Fast Switching
Type

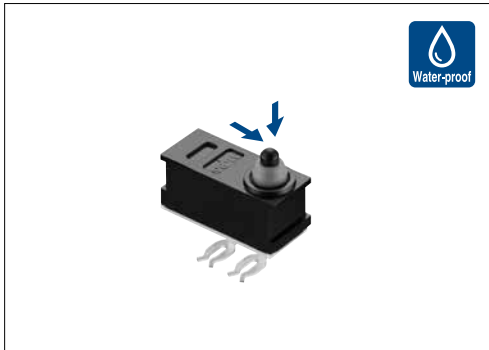

Typical Specifications

Items		Specifications
Rating (max.)/(min.) (Resistive load)		0.1A 12V DC / 50μA 5V DC
Contact resistance (Initial / After operating life)		500mΩ max. / 1Ω max.
Operating force		1±0.5N
Operating life	Without load	300,000cycles
	With load	300,000cycles (0.1A 12V DC)

Product Line

Poles	Positions	Change over timing	Operating part shape	Terminal type	Main body form	Minimum order unit (pcs)		Product No.	Drawing No.	
						Japan	Export			
1	1	Non shorting	Push	Press fit (Without terminal No.3)	Without boss L type	1,200	4,800	SPVQA10103	1	
					Without boss R type			SPVQA10203	2	
				Press fit (Without terminal No.2)	Without boss L type			SPVQA10302	3	
					Without boss R type			SPVQA10402	4	
	Press fit			Without boss L type	SPVQA10504			5		
				Without boss R type	SPVQA10604			6		
	1			2	For PC board (Without terminal No.3)			Without boss	SPVQA20103	7
									For PC board	SPVQA20203

Note

This unit cannot be used in water (IP67 rating, except for terminal).

Packing Specifications

Number of packages (pcs.)		Export package measurements (mm)
1 case /Japan	1 case /export packing	
1,200	4,800	540×360×270

Dimensions

Unit:mm

No.	Style	No.	Style
1		2	

■ Dimensions

Unit:mm

No.	Style	No.	Style
3	<p>Technical drawing of style 3 showing dimensions: 15.2, 12.2, 6.4, 0.7, 3.5, 3.22, 11.48, 2-0.31, 3.8, 0.8, 0.4, 1.8, 0.4, 90°, 4.1max, 7.95, 3.6, 3.2, 0.7, 4.1max, 7.95, 0.7, 15.2, 12.2, 6.4, 0.7, 3.5, 3.22, 11.48, 2-0.31, 3.8, 0.8, 0.4, 1.8, 0.4, 90°, 4.1max, 7.95, 3.6, 3.2, 0.7, 4.1max, 7.95, 0.7. Labels include: Limit total travel position, Terminal No.①-③ OFF starting position, Free position, The top of the plunger (Measurement position), Terminal No.③, Terminal No.①, Terminal No.②.</p>	6	<p>Technical drawing of style 6 showing dimensions: 15.2, 12.2, 6.4, 0.7, 3.5, 3.22, 11.48, 2-0.31, 3.8, 0.8, 0.4, 1.8, 0.4, 90°, 4.1max, 7.95, 3.6, 3.2, 0.7, 4.1max, 7.95, 0.7, 15.2, 12.2, 6.4, 0.7, 3.5, 3.22, 11.48, 2-0.31, 3.8, 0.8, 0.4, 1.8, 0.4, 90°, 4.1max, 7.95, 3.6, 3.2, 0.7, 4.1max, 7.95, 0.7. Labels include: Limit total travel position, Terminal No.①-② ON starting position, Terminal No.①-③ OFF starting position, Free position, The top of the plunger (Measurement position), Terminal No.③, Terminal No.②, Terminal No.①.</p>
4	<p>Technical drawing of style 4 showing dimensions: 15.2, 12.2, 6.4, 0.7, 3.5, 3.22, 11.48, 2-0.31, 3.8, 0.8, 0.4, 1.8, 0.4, 90°, 4.1max, 7.95, 3.6, 3.2, 0.7, 4.1max, 7.95, 0.7, 15.2, 12.2, 6.4, 0.7, 3.5, 3.22, 11.48, 2-0.31, 3.8, 0.8, 0.4, 1.8, 0.4, 90°, 4.1max, 7.95, 3.6, 3.2, 0.7, 4.1max, 7.95, 0.7. Labels include: Limit total travel position, Terminal No.①-③ OFF starting position, Free position, The top of the plunger (Measurement position), Terminal No.③, Terminal No.②, Terminal No.①.</p>	7	<p>Technical drawing of style 7 showing dimensions: 15.2, 12.2, 6.4, 0.7, 3.5, 3.22, 11.48, 2-0.31, 3.8, 0.8, 0.4, 1.8, 0.4, 90°, 4.1max, 7.95, 3.6, 3.2, 0.7, 4.1max, 7.95, 0.7, 15.2, 12.2, 6.4, 0.7, 3.5, 3.22, 11.48, 2-0.31, 3.8, 0.8, 0.4, 1.8, 0.4, 90°, 4.1max, 7.95, 3.6, 3.2, 0.7, 4.1max, 7.95, 0.7. Labels include: Limit total travel position, Terminal No.①-② ON starting position, Free position, The top of the plunger (Measurement position), Terminal No.③, Terminal No.①, Terminal No.②.</p>
5	<p>Technical drawing of style 5 showing dimensions: 15.2, 12.2, 6.4, 0.7, 3.5, 3.22, 11.48, 2-0.31, 3.8, 0.8, 0.4, 1.8, 0.4, 90°, 4.1max, 7.95, 3.6, 3.2, 0.7, 4.1max, 7.95, 0.7, 15.2, 12.2, 6.4, 0.7, 3.5, 3.22, 11.48, 2-0.31, 3.8, 0.8, 0.4, 1.8, 0.4, 90°, 4.1max, 7.95, 3.6, 3.2, 0.7, 4.1max, 7.95, 0.7. Labels include: Limit total travel position, Terminal No.①-② ON starting position, Terminal No.①-③ OFF starting position, Free position, The top of the plunger (Measurement position), Terminal No.③, Terminal No.①, Terminal No.②.</p>	8	<p>Technical drawing of style 8 showing dimensions: 15.2, 12.2, 6.4, 0.7, 3.5, 3.22, 11.48, 2-0.31, 3.8, 0.8, 0.4, 1.8, 0.4, 90°, 4.1max, 7.95, 3.6, 3.2, 0.7, 4.1max, 7.95, 0.7, 15.2, 12.2, 6.4, 0.7, 3.5, 3.22, 11.48, 2-0.31, 3.8, 0.8, 0.4, 1.8, 0.4, 90°, 4.1max, 7.95, 3.6, 3.2, 0.7, 4.1max, 7.95, 0.7. Labels include: Limit total travel position, Terminal No.①-② ON starting position, Terminal No.①-③ OFF starting position, Free position, The top of the plunger (Measurement position), Terminal No.③, Terminal No.①, Terminal No.②.</p>

■ Circuit Diagram

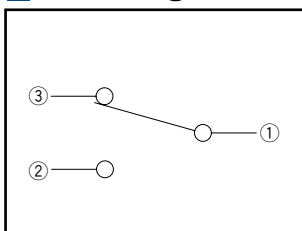

- Detector
- Slide
- Push
- Rotary
- Power
- Dual-in-line Package Type
- General-purpose Type
- Water-proof Type
- Fast Switching Type

Detector

Slide

Push

Rotary

Power

Dual-in-line
Package Type

General-
purpose Type

Waterproof
Type

Fast Switching
Type









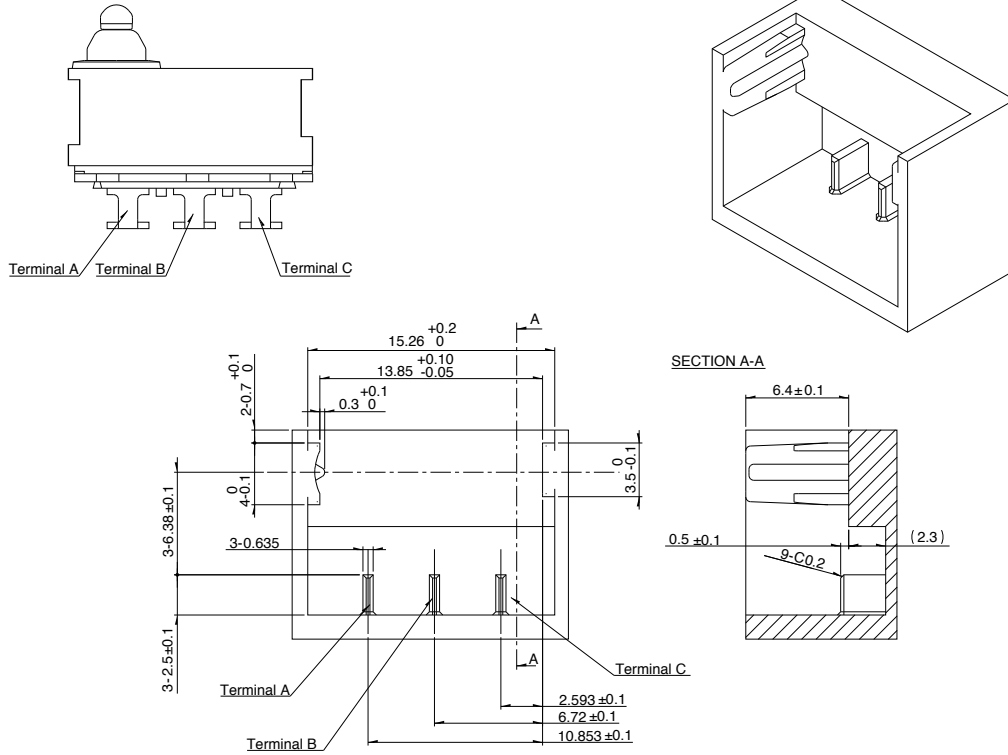

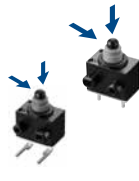
Reference Drawing for Unit Terminals

Unit:mm

Style

SPVQA10504



Series		Water-proof Type			Fast Switching Type	
		SPVQ8	SPVQA	SSCN	SPVQ9	SPVQC
Photo						
Operation type		Two-way				
Dimensions (mm)	W	8.3	15.2	13	15.4	15.4
	D	5.3	6.4	5	8.4	7.4
	H	6.5	7.95	15	7.5	
Operating temperature range		-40°C to +85°C				
Automotive use		●	●	●	●	●
Life cycle (availability)						
Poles / Positions		1/1	1/1 1/2	1/2	2/2	
Rating (max.) (Resistive load)		0.1A 12V DC			50mA 26V DC	50mA 18V DC
Rating (min.) (Resistive load)		50μA 5V DC		100μA 5V DC	50μA 5V DC	
Durability	Operating life without load	300,000cycles 1Ω max. or 1,000,000cycles 3Ω max.	300,000cycles 1Ω max.	100,000cycles 1Ω max.	300,000cycles 200mΩ max.	—
	Operating life with load Rating (max.) (Resistive load)	300,000cycles 1Ω max. or 1,000,000cycles 3Ω max.	300,000cycles 1Ω max.	100,000cycles 1Ω max.	300,000cycles 200mΩ max.	
Electrical performance	Initial contact resistance	500mΩ max.			75mΩ max.	
	Insulation resistance	100MΩ min. 500V DC				100MΩ min. 250V DC
	Voltage proof	500V AC for 1minute				250V AC for 1minute
Mechanical performance	Terminal strength	3N for 1minute (with terminal) Wire strength 30N for 1minute (with wire)	3N for 1minute			
	Actuator strength	20N		10N	20N	
Environmental performance	Cold	-40°C 500h				
	Dry heat	85°C 500h				
	Damp heat	60°C, 90 to 95% RH 500h				
Operation force		1±0.5N		2N max.	1±0.5N	
Page		55	60	63	64	65

Detector Switches Soldering Conditions 66
 Detector Switches Cautions 67

Note
 ● Indicates applicability to all products in the series.

Example of Reflow Soldering Condition

1. Heating method: Double heating method with infrared heater.
2. Temperature measurement: Thermocouple $\phi 0.1$ to 0.2 CA (K) or CC (T) at soldering portion (copper foil surface).
A heat resisting tape should be used for fixed measurement.
3. Temperature profile

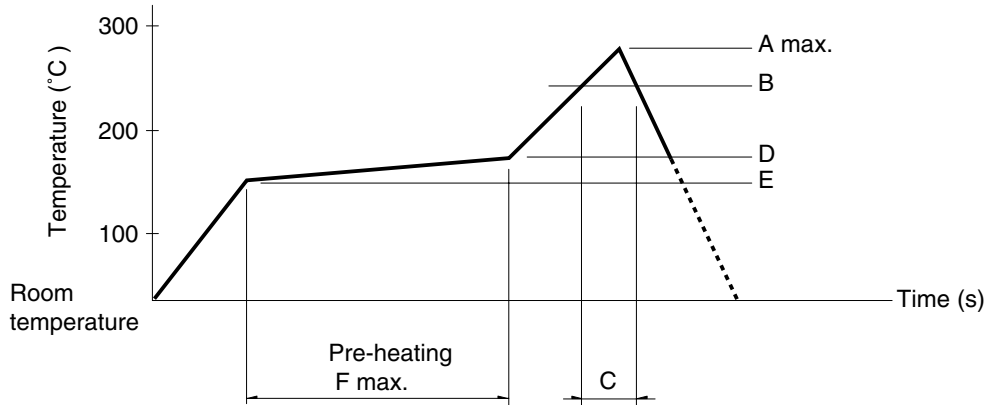

Series (Reflow type)	A (°C) 3s max.	B (°C)	C (s)	D (°C)	E (°C)	F (s)
SPPB	250	230	40	180	150	120
SPVE	260		40			
SPVL						
SPVM						
SPVN						
SPVR						
SPVS						
SPVT						
SSCM						
SSCQ						
SPVQC	250					

Notes

1. The condition mentioned above is the temperature on the mounting surface of a PC board. There are cases where the PC board's temperature greatly differs from that of the switch, surface depending on the PC board's material, size, thickness, etc.
The above-stated conditions shall also apply to switch surface temperatures.
2. Soldering conditions differ depending on reflow soldering machines.
Prior verification of soldering condition is highly recommended.

Reference for Hand Soldering

Series	Soldering temperature	Soldering time
SPVS, SPVN, SPVT, SPVM, SPVR, SPVE, SSCQ, SSCM, SPVL, SSCT, SPVQC	350±5°C	3s max.
SPVQ1, SPVQ3, SPVQ6, SPVQ7, SPVQ8, SPVQ9, SSCN, SPVQA	300±10°C	3 + 1 / 0s
SPPB (Reflow)	300±5°C	5s max.
SSCF, SPPB (For Lead, Dip)	350±10°C	3 + 1 / 0s

Reference for Dip Soldering (For PC board terminal types)

Series	Items		Dip soldering	
	Preheating temperature	Preheating time	Soldering temperature	Duration of immersion
SSCT, SPVQ1, SPVQ3, SPVQ6, SPVQ7, SPVQ8, SPVQ9, SPVQA	100±10°C	60s max.	260±5°C	5±1s
SPPW8, SPPB	100°C max.	60s max.	255±5°C	5±1s
SSCF	—		260±5°C	5±1s



Компания «ЭлектроПласт» предлагает заключение долгосрочных отношений при поставках импортных электронных компонентов на взаимовыгодных условиях!

Наши преимущества:

- Оперативные поставки широкого спектра электронных компонентов отечественного и импортного производства напрямую от производителей и с крупнейших мировых складов;
- Поставка более 17-ти миллионов наименований электронных компонентов;
- Поставка сложных, дефицитных, либо снятых с производства позиций;
- Оперативные сроки поставки под заказ (от 5 рабочих дней);
- Экспресс доставка в любую точку России;
- Техническая поддержка проекта, помощь в подборе аналогов, поставка прототипов;
- Система менеджмента качества сертифицирована по Международному стандарту ISO 9001;
- Лицензия ФСБ на осуществление работ с использованием сведений, составляющих государственную тайну;
- Поставка специализированных компонентов (Xilinx, Altera, Analog Devices, Intersil, Interpoint, Microsemi, Aeroflex, Peregrine, Syfer, Eurofarad, Texas Instrument, Miteq, Cobham, E2V, MA-COM, Hittite, Mini-Circuits, General Dynamics и др.);

Помимо этого, одним из направлений компании «ЭлектроПласт» является направление «Источники питания». Мы предлагаем Вам помощь Конструкторского отдела:

- Подбор оптимального решения, техническое обоснование при выборе компонента;
- Подбор аналогов;
- Консультации по применению компонента;
- Поставка образцов и прототипов;
- Техническая поддержка проекта;
- Защита от снятия компонента с производства.



Как с нами связаться

Телефон: 8 (812) 309 58 32 (многоканальный)

Факс: 8 (812) 320-02-42

Электронная почта: org@eplast1.ru

Адрес: 198099, г. Санкт-Петербург, ул. Калинина, дом 2, корпус 4, литера А.