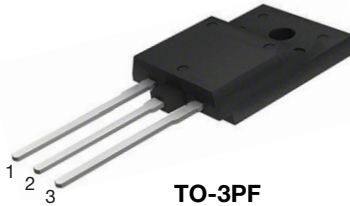
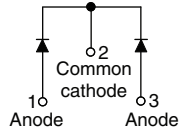

## Ultrafast Soft Recovery Diode, 2 x 30 A FRED Pt<sup>®</sup> Gen 4

**TO-3PF**

**FEATURES**

- Gen 4 FRED Pt technology
- Low  $I_{RRM}$  and reverse recovery charge
- Very low forward voltage drop
- Polyimide passivated chip for high reliability
- Fully isolated package ( $V_{INS} = 2500 V_{RMS}$ )
- 175 °C operating junction temperature
- Material categorization: for definitions of compliance please see [www.vishay.com/doc?99912](http://www.vishay.com/doc?99912)

**RoHS**  
COMPLIANT

PRODUCT SUMMARY	
Package	TO-3PF
$I_{F(AV)}$ per leg	30 A
$V_R$	600 V
$V_F$ at $I_F$	1.20 V
$t_{rr}$ typ.	37 ns
$T_J$ max.	175 °C
Diode variation	Common cathode

**DESCRIPTION**

Gen 4 Fred Pt technology, state of the art, ultralow  $V_F$ , soft switching optimized for Discontinuous (Critical) Mode (DCM) and IGBT F/W diode.

The minimized conduction loss, optimized stored charge and low recovery current minimize the switching losses and reduce over dissipation in the switching element and snubbers.

ABSOLUTE MAXIMUM RATINGS				
PARAMETER	SYMBOL	TEST CONDITIONS	MAX.	UNITS
Peak repetitive reverse voltage	$V_{RRM}$		600	V
Average rectified forward current, per leg	$I_{F(AV)}$	$T_C = 75\text{ °C}$	30	A
Non-repetitive peak surge current, per leg	$I_{FSM}$	$T_C = 25\text{ °C}$ , $t_p = 8.3\text{ ms}$ half sine wave	255	
Operating junction and storage temperature	$T_J, T_{Stg}$		-55 to +175	°C

ELECTRICAL SPECIFICATIONS ( $T_J = 25\text{ °C}$ unless otherwise specified)						
PARAMETER	SYMBOL	TEST CONDITIONS	MIN.	TYP.	MAX.	UNITS
Breakdown voltage, blocking voltage	$V_{BR}, V_R$	$I_R = 100\text{ }\mu\text{A}$	600	-	-	V
Forward voltage	$V_F$	$I_F = 30\text{ A}$	-	1.4	1.65	
		$I_F = 50\text{ A}$	-	1.56	1.97	
		$I_F = 30\text{ A}, T_J = 150\text{ °C}$	-	1.20	1.45	
		$I_F = 50\text{ A}, T_J = 150\text{ °C}$	-	1.43	-	
Reverse leakage current	$I_R$	$V_R = V_R$ rated	-	-	50	$\mu\text{A}$
		$T_J = 125\text{ °C}, V_R = V_R$ rated	-	-	500	
Junction capacitance	$C_T$	$V_R = 600\text{ V}$	-	19	-	pF



DYNAMIC RECOVERY CHARACTERISTICS (T <sub>J</sub> = 25 °C unless otherwise specified)						
PARAMETER	SYMBOL	TEST CONDITIONS	MIN.	TYP.	MAX.	UNITS
Reverse recovery time, per leg	t <sub>rr</sub>	I <sub>F</sub> = 1 A, di <sub>F</sub> /dt = 100 A/μs, V <sub>R</sub> = 30 V	-	36	-	ns
		T <sub>J</sub> = 25 °C	-	70	-	
		T <sub>J</sub> = 125 °C	-	100	-	
Peak recovery current, per leg	I <sub>RRM</sub>	T <sub>J</sub> = 25 °C	-	17	-	A
		T <sub>J</sub> = 125 °C	-	30	-	
Reverse recovery charge, per leg	Q <sub>rr</sub>	T <sub>J</sub> = 25 °C	-	800	-	nC
		T <sub>J</sub> = 125 °C	-	1800	-	

THERMAL - MECHANICAL SPECIFICATIONS						
PARAMETER	SYMBOL	TEST CONDITIONS	MIN.	TYP.	MAX.	UNITS
Thermal resistance, junction to case	R <sub>thJC</sub>		-	-	2.4	°C/W
Thermal resistance, case to heatsink	R <sub>thCS</sub>		-	0.4	-	
Weight			-	6.0	-	g
			-	0.21	-	oz.
Mounting torque			4.0 (3.5)	-	6.0 (5.3)	kgf · cm (lbf · in)
Marking device		Case style TO-3PF	C4ZU6006FP			

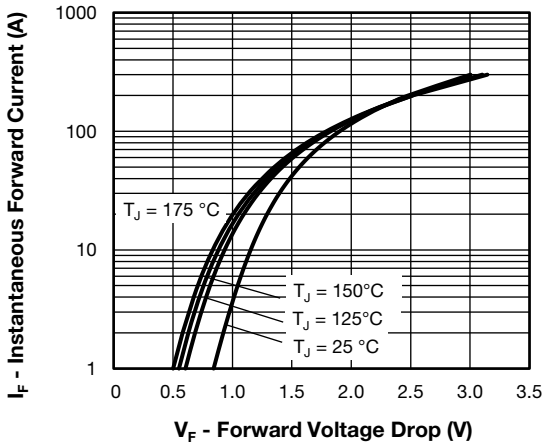

Fig. 1 - Typical Forward Voltage Drop Characteristics

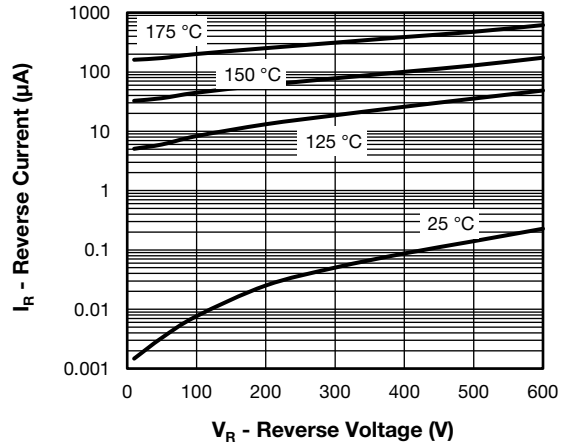

Fig. 2 - Typical Values of Reverse Current vs. Reverse Voltage

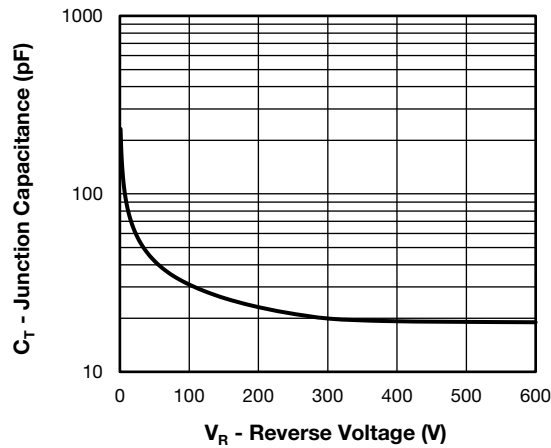

Fig. 3 - Typical Junction Capacitance vs. Reverse Voltage

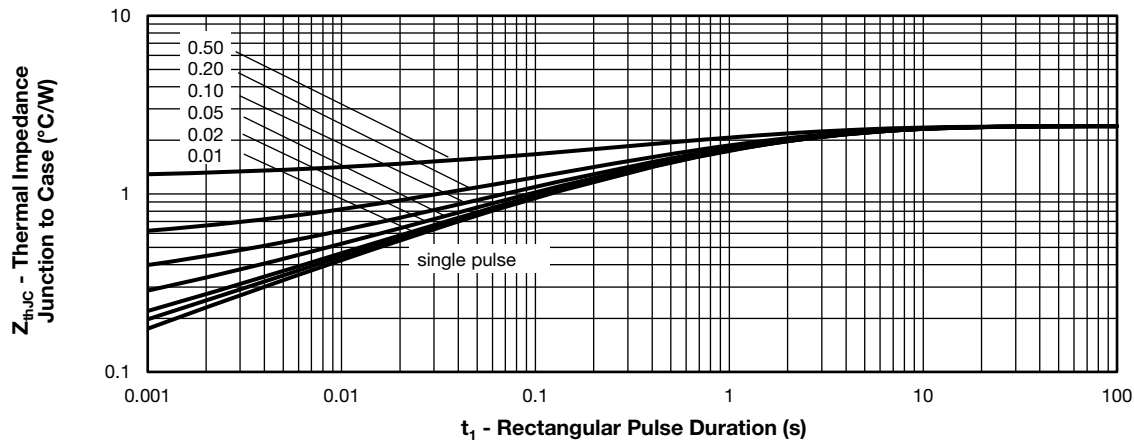

Fig. 4 - Max. Thermal Impedance  $Z_{thJC}$  Characteristics

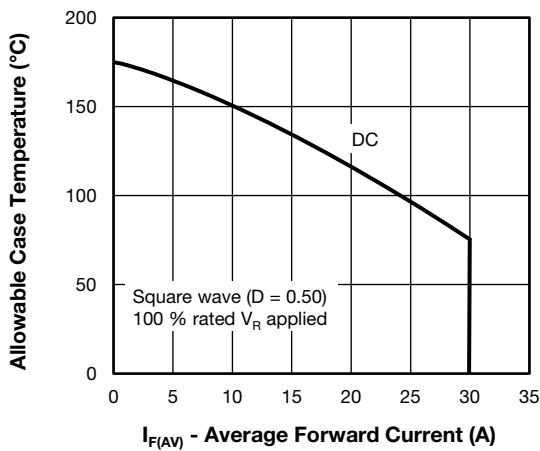

Fig. 5 - Maximum Allowable Case Temperature vs. Average Forward Current

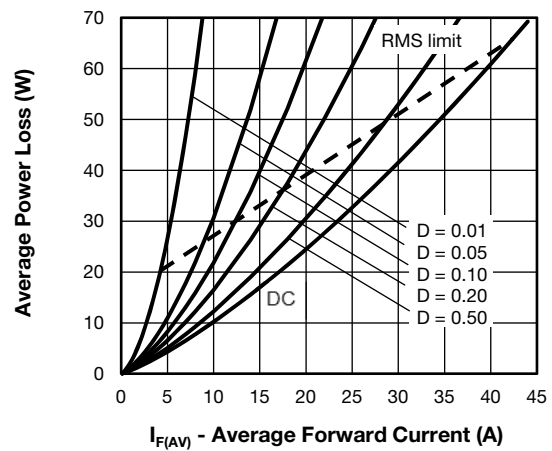

Fig. 6 - Forward Power Loss Characteristics

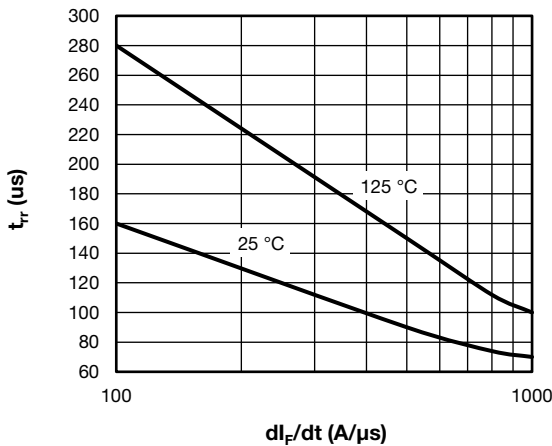

Fig. 7 - Typical Reverse Recovery Time vs.  $dI_F/dt$

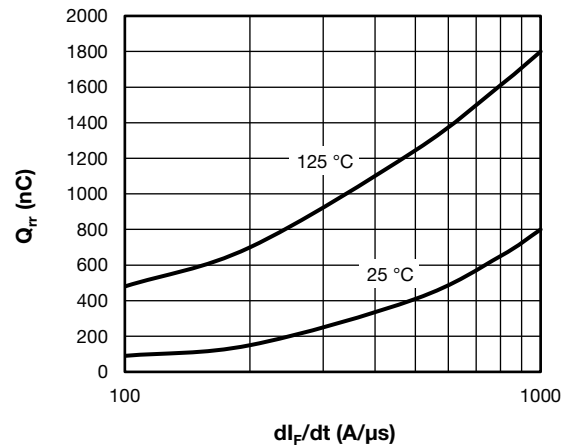

Fig. 8 - Typical Stored Charge vs.  $dI_F/dt$

**ORDERING INFORMATION TABLE**

Device code	<b>VS-</b>	<b>C</b>	<b>4</b>	<b>Z</b>	<b>U</b>	<b>60</b>	<b>06</b>	<b>FP</b>	<b>-E3</b>
	①	②	③	④	⑤	⑥	⑦	⑧	⑨

- 1** - Vishay Semiconductors product
- 2** - Circuit configuration:  
C = common cathode
- 3** - FRED Pt Gen 4
- 4** - Z = TO-3PF package
- 5** - Process type:  
U = ultrafast recovery
- 6** - Current rating (60 = 2 x 30 A)
- 7** - Voltage rating (06 = 600 V)
- 8** - FULL-PAK
- 9** - Environmental digit:  
RoHS-compliant, terminations lead (Pb)-free

<b>ORDERING INFORMATION</b> (Example)			
PREFERRED P/N	QUANTITY PER TUBE	MINIMUM ORDER QUANTITY	PACKAGING DESCRIPTION
VS-C4ZU6006FP-E3	30	1200	Antistatic plastic tube

<b>LINKS TO RELATED DOCUMENTS</b>		
Dimensions	TO-3PF	<a href="http://www.vishay.com/doc?95646">www.vishay.com/doc?95646</a>
Part marking information	TO-3PF	<a href="http://www.vishay.com/doc?95699">www.vishay.com/doc?95699</a>



## TO-3PF

**DIMENSIONS** in millimeters

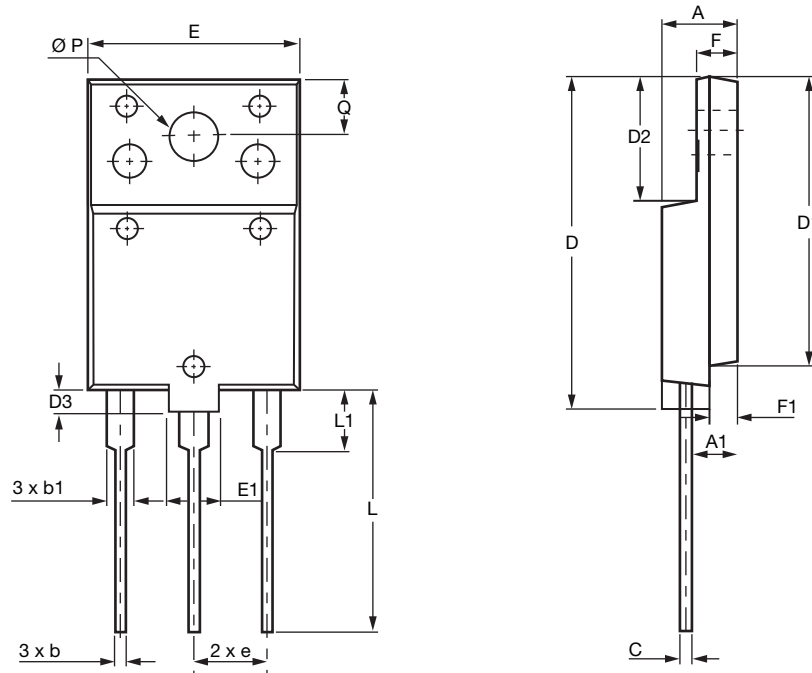

SYMBOL	MIN.	NOM.	MAX.
A	5.30	5.50	5.70
A1	3.10	3.30	3.50
b	0.65	0.75	0.95
b1	1.80	2.00	2.20
c	0.80	0.90	1.10
D	26.30	26.50	26.70
D1	22.80	23.00	23.20
D2	9.80	10.00	10.20
D3	1.80	2.00	2.20
E	15.30	15.50	15.70
E1	3.80	4.00	4.20
e	5.45 BSC		
F	2.80	3.00	3.20
F1	1.80	2.00	2.20
L	19.10	19.30	19.50
L1	4.80	5.00	5.20
Q	4.30	4.50	4.70
Ø P	3.40	3.60	3.80



## **Disclaimer**

ALL PRODUCT, PRODUCT SPECIFICATIONS AND DATA ARE SUBJECT TO CHANGE WITHOUT NOTICE TO IMPROVE RELIABILITY, FUNCTION OR DESIGN OR OTHERWISE.

Vishay Intertechnology, Inc., its affiliates, agents, and employees, and all persons acting on its or their behalf (collectively, "Vishay"), disclaim any and all liability for any errors, inaccuracies or incompleteness contained in any datasheet or in any other disclosure relating to any product.

Vishay makes no warranty, representation or guarantee regarding the suitability of the products for any particular purpose or the continuing production of any product. To the maximum extent permitted by applicable law, Vishay disclaims (i) any and all liability arising out of the application or use of any product, (ii) any and all liability, including without limitation special, consequential or incidental damages, and (iii) any and all implied warranties, including warranties of fitness for particular purpose, non-infringement and merchantability.

Statements regarding the suitability of products for certain types of applications are based on Vishay's knowledge of typical requirements that are often placed on Vishay products in generic applications. Such statements are not binding statements about the suitability of products for a particular application. It is the customer's responsibility to validate that a particular product with the properties described in the product specification is suitable for use in a particular application. Parameters provided in datasheets and / or specifications may vary in different applications and performance may vary over time. All operating parameters, including typical parameters, must be validated for each customer application by the customer's technical experts. Product specifications do not expand or otherwise modify Vishay's terms and conditions of purchase, including but not limited to the warranty expressed therein.

Except as expressly indicated in writing, Vishay products are not designed for use in medical, life-saving, or life-sustaining applications or for any other application in which the failure of the Vishay product could result in personal injury or death. Customers using or selling Vishay products not expressly indicated for use in such applications do so at their own risk. Please contact authorized Vishay personnel to obtain written terms and conditions regarding products designed for such applications.

No license, express or implied, by estoppel or otherwise, to any intellectual property rights is granted by this document or by any conduct of Vishay. Product names and markings noted herein may be trademarks of their respective owners.



Компания «ЭлектроПласт» предлагает заключение долгосрочных отношений при поставках импортных электронных компонентов на взаимовыгодных условиях!

Наши преимущества:

- Оперативные поставки широкого спектра электронных компонентов отечественного и импортного производства напрямую от производителей и с крупнейших мировых складов;
- Поставка более 17-ти миллионов наименований электронных компонентов;
- Поставка сложных, дефицитных, либо снятых с производства позиций;
- Оперативные сроки поставки под заказ (от 5 рабочих дней);
- Экспресс доставка в любую точку России;
- Техническая поддержка проекта, помощь в подборе аналогов, поставка прототипов;
- Система менеджмента качества сертифицирована по Международному стандарту ISO 9001;
- Лицензия ФСБ на осуществление работ с использованием сведений, составляющих государственную тайну;
- Поставка специализированных компонентов (Xilinx, Altera, Analog Devices, Intersil, Interpoint, Microsemi, Aeroflex, Peregrine, Syfer, Eurofarad, Texas Instrument, Miteq, Cobham, E2V, MA-COM, Hittite, Mini-Circuits, General Dynamics и др.);

Помимо этого, одним из направлений компании «ЭлектроПласт» является направление «Источники питания». Мы предлагаем Вам помощь Конструкторского отдела:

- Подбор оптимального решения, техническое обоснование при выборе компонента;
- Подбор аналогов;
- Консультации по применению компонента;
- Поставка образцов и прототипов;
- Техническая поддержка проекта;
- Защита от снятия компонента с производства.



#### Как с нами связаться

**Телефон:** 8 (812) 309 58 32 (многоканальный)

**Факс:** 8 (812) 320-02-42

**Электронная почта:** [org@eplast1.ru](mailto:org@eplast1.ru)

**Адрес:** 198099, г. Санкт-Петербург, ул. Калинина, дом 2, корпус 4, литера А.