

Thin-Film Low Pass Filter



LP0603 Lead-Free LGA Type

GENERAL DESCRIPTION

The LP0603 ITF (Integrated Thin Film) Lead-Free LGA Low Pass Filter is based on thin-film multilayer technology. The technology provides a miniature part with excellent high frequency performance and rugged construction for reliable automatic assembly.

The ITF Low Pass Filters are offered in a variety of frequency bands compatible with various types of high frequency wireless systems.

FEATURES

- Miniature Size: 0603
- Frequency Range: 900MHz -2.4GHz
- Characteristic Impedance: 50 Ohm
- Operating/Storage Temperature: -40°C to +85°C
- Power Rating: 3W Continuous
- Low Profile
- Rugged Construction
- Lead Free
- Taped and Reeled

APPLICATIONS

- Mobile communications
- Satellite TV receivers
- GPS
- Vehicle location systems
- Wireless LANs
- RFID

LAND GRID ARRAY ADVANTAGES

- Inherent Low Profile
- Self Alignment during Reflow
- Excellent Solderability
- Low Parasitics
- Better Heat Dissipation

HOW TO ORDER

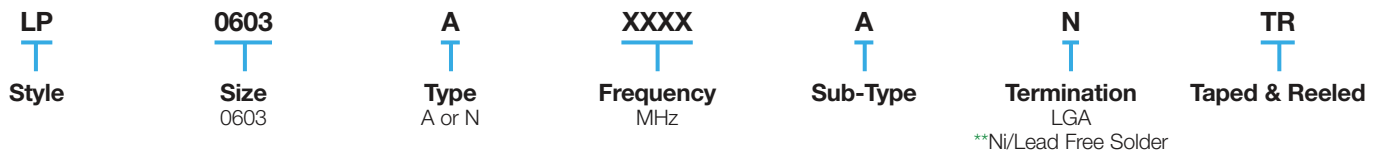

**Ni/Lead Free Solder

****RoHS compliant**

FINAL QUALITY INSPECTION

Finished parts are 100% tested for electrical parameters and visual characteristics. Each production lot is evaluated on a sample basis for:

- Static Humidity: 85°C, 85% RH, 160 hours
- Endurance: 125°C, IR, 4 hours

TERMINATION

Nickel/Lead-Free Solder coating compatible with automatic soldering technologies: reflow, wave soldering, vapor phase and manual.



Thin-Film Low Pass Filter



LP0603 Lead-Free LGA Type

DIMENSIONS: millimeters (inches) (Bottom View)

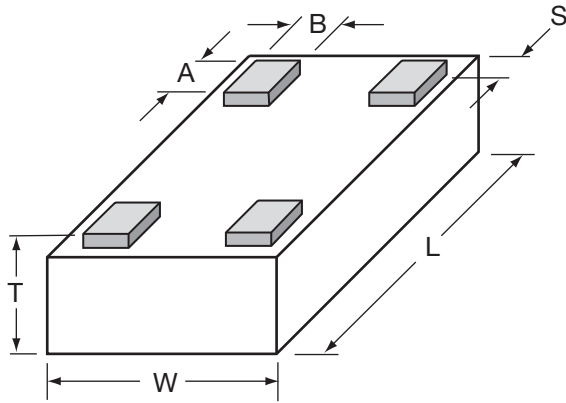

| | | | |
|---|---------------------------|---|----------------------------|
| L | 1.6±0.1 (0.063±0.004) | A | 0.25±0.05 (0.010±0.002) |
| W | 0.84±0.1 (0.033±0.004) | B | 0.20±0.05 (0.008±0.002) |
| T | 0.60±0.1 (0.024±0.004) | S | 0.05±0.05 (0.002±0.002) |

TERMINALS AND ORIENTATION IN TAPE (Top View)

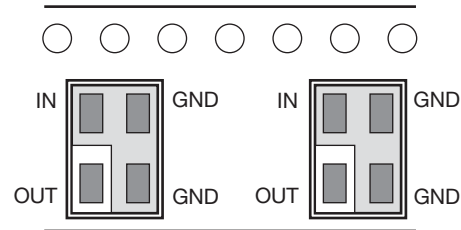

RECOMMENDED PAD LAYOUT (mm)

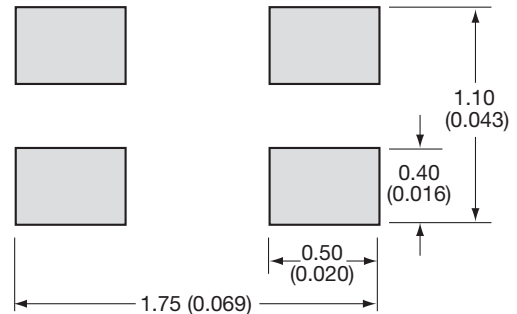

ELECTRICAL CHARACTERISTICS

(Guaranteed over -40°C to $+85^{\circ}\text{C}$ Operating Temperature Range)

| P/N | Frequency Band [MHz] | I. Loss [dB] | VSWR max [dB] | Attenuation typ. [dB] |
|-----------------|----------------------|------------------------|---------------|--|
| LP0603A0902ANTR | 890-915 | 0.35 typ (0.5 max) | 1.4 | 25 @ 2xF ₀ 14 @ 3xF ₀ |
| LP0603A0947ANTR | 935-960 | 0.35 typ (0.5 max) | 1.4 | 25 @ 2xF ₀ 17 @ 3xF ₀ |
| LP0603A1747ANTR | 1710-1785 | 0.3 typ (0.5 max) | 1.4 | 25 @ 2xF ₀ 17 @ 3xF ₀ |
| LP0603A1842ANTR | 1805-1880 | 0.3 typ (0.5 max) | 1.4 | 27 @ 2xF ₀ 15 @ 3xF ₀ |
| LP0603A1880ANTR | 1840-1920 | 0.3 typ (0.5 max) | 1.4 | 25 @ 2xF ₀ 17 @ 3xF ₀ |
| LP0603A1950ANTR | 1920-1980 | 0.3 typ (0.5 max) | 1.4 | 27 @ 2xF ₀ 15 @ 3xF ₀ |
| LP0603A2140ANTR | 2110-2170 | 0.3 typ (0.5 max) | 1.4 | 27 @ 2xF ₀ 17 @ 3xF ₀ |
| LP0603A2442ANTR | 2412-2472 | 0.3 typ (0.5 max) | 1.4 | 25 @ 2xF ₀ 17 @ 3xF ₀ |
| LP0603N3500ANTR | 3400-3600 | -0.3 typ. -0.5 max. | 1.4 | 30 @ 2xF ₀ 20 @ 3xF ₀ |
| LP0603N5200ANTR | 5050-5350 | -0.2 typ. -0.5 max. | 1.4 | 30 @ 2xF ₀ 20 @ 3xF ₀ |
| LP0603N5500ANTR | 5350-5650 | -0.2 typ. -0.5 max. | 1.4 | 30 @ 2xF ₀ 20 @ 3xF ₀ |

Note: additional frequencies available upon request

Thin-Film Low Pass Filter

LP0603 Lead-Free LGA Type Test Jig

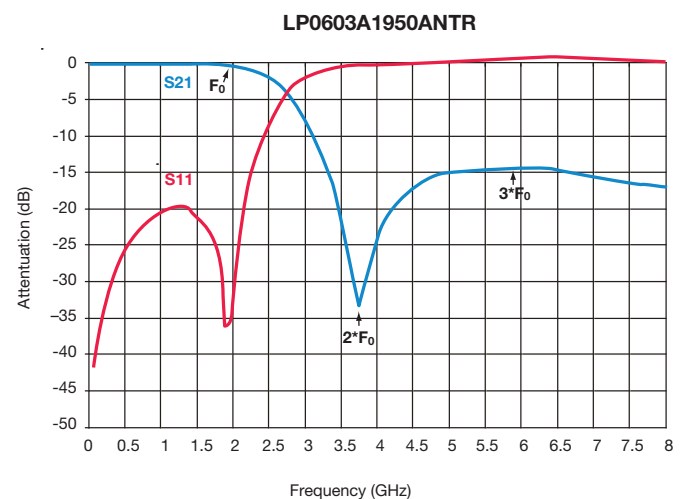
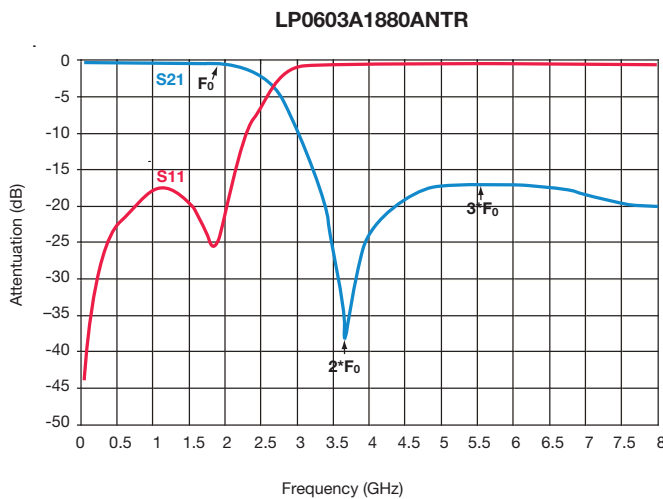
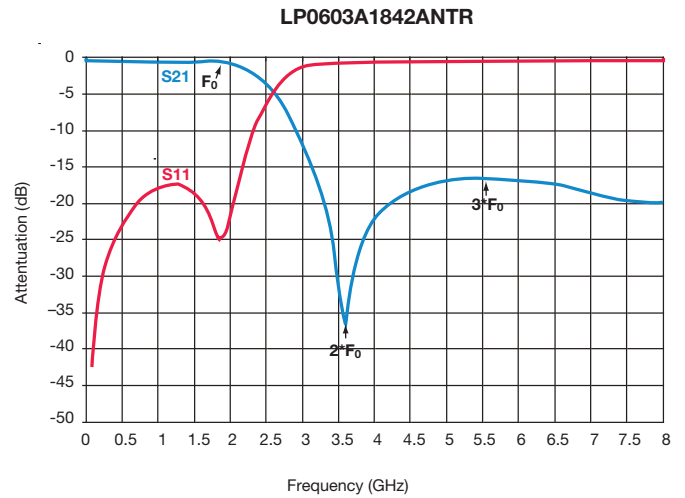
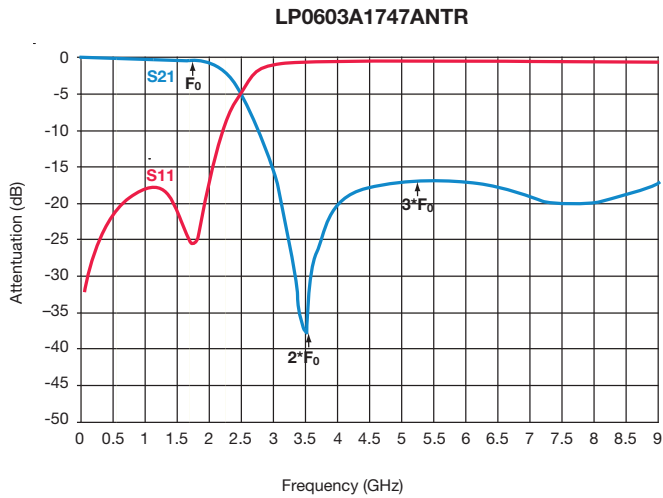
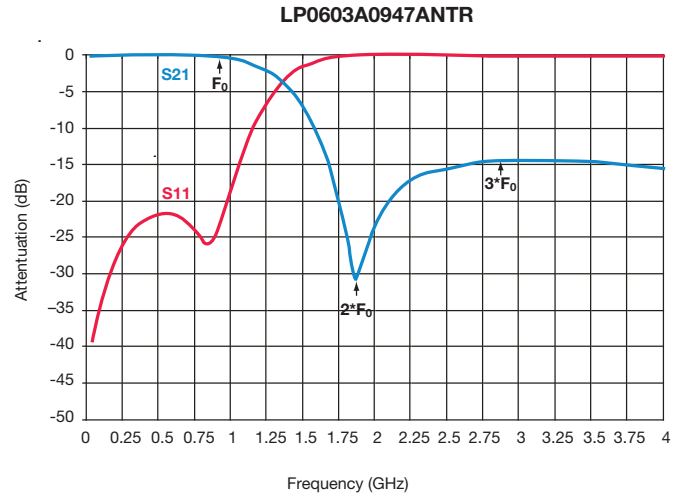
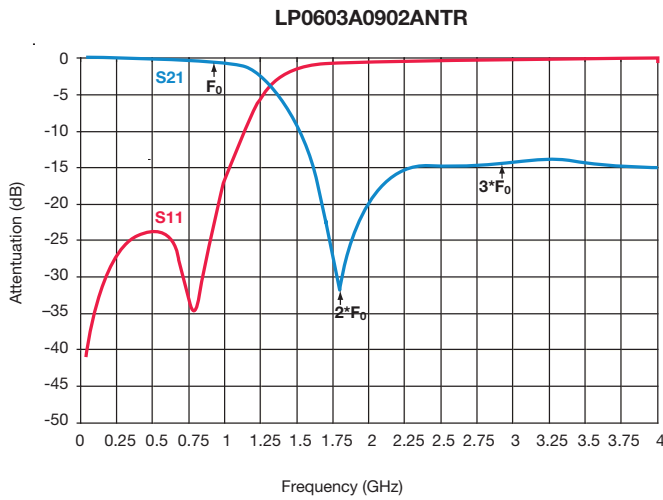

4

Thin-Film Low Pass Filter

LP0603 Lead-Free LGA Type Test Jig

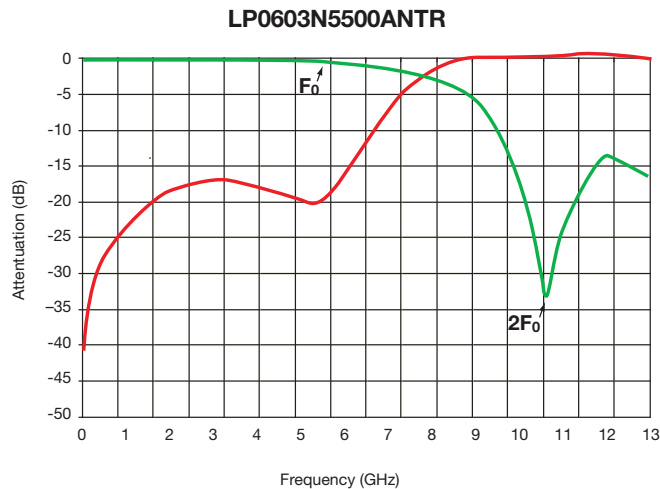
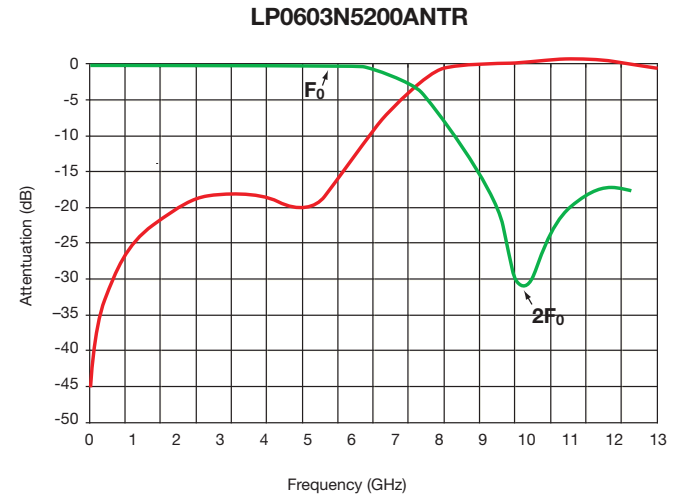
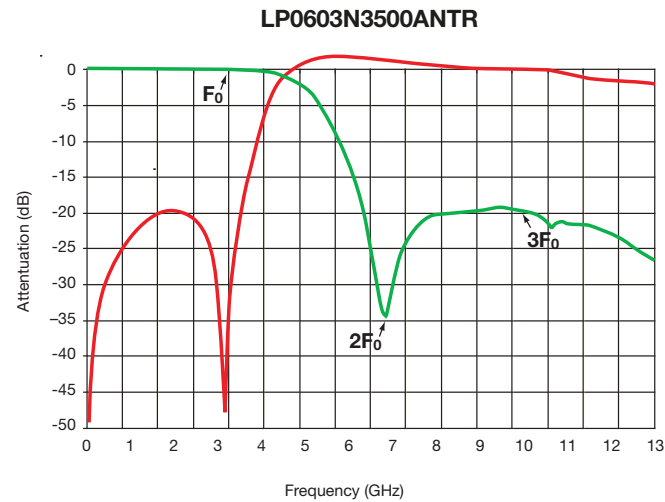
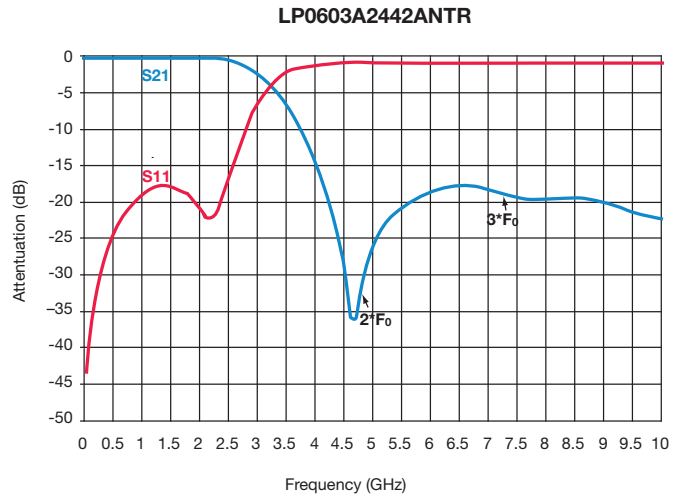
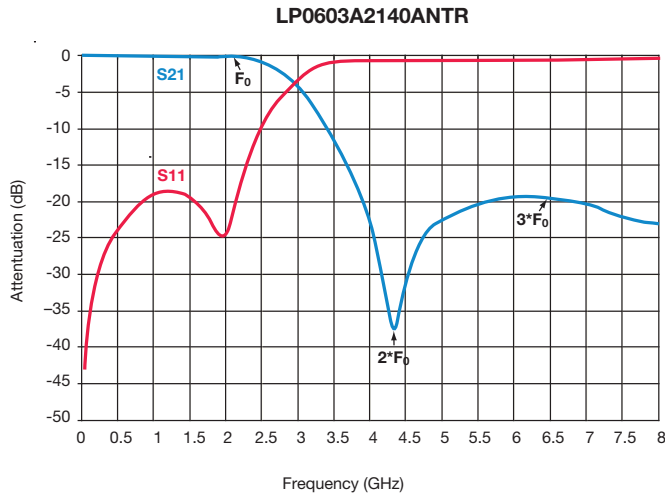

4

Thin-Film Low Pass Filter

LP0603 Lead-Free LGA Type Test Jig

TEST JIG FOR LP0603 LEAD-FREE LGA LOW PASS FILTER

GENERAL DESCRIPTION

These jigs are designed for testing the LP0603 LGA Low Pass Filters using a Vector Network Analyzer.

They consist of a dielectric substrate, having 50Ω microstrips as conducting lines and a bottom ground plane located at a distance of 0.127mm from the microstrips.

The substrate used is Neltec's NH9338ST0127C1BC (or similar).

The connectors are SMA type (female), 'Johnson Components Inc.' Product P/N: 142-0701-841 (or similar).

Both a measurement jig and a calibration jig are provided.

The calibration jig is designed for a full 2-port calibration, and consists of an open line, short line and through line. LOAD calibration can be done by a 50Ω SMA termination.

MEASUREMENT PROCEDURE

Follow the VNA's instruction manual and use the [calibration jig](#) to perform a full 2-Port calibration in the required bandwidths.

Solder the filter to the [measurement jig](#) as follows:

- | | | | |
|-----------------|---------------------|--------------|-------------|
| Input (Filter) | ➔ Connector 1 (Jig) | GND (Filter) | ➔ GND (Jig) |
| Output (Filter) | ➔ Connector 2 (Jig) | GND (Filter) | ➔ GND (Jig) |

Set the VNA to the relevant frequency band. Connect the VNA using a 10dB attenuator on the jig terminal connected to port 2 (using an RF cable).

Measurement

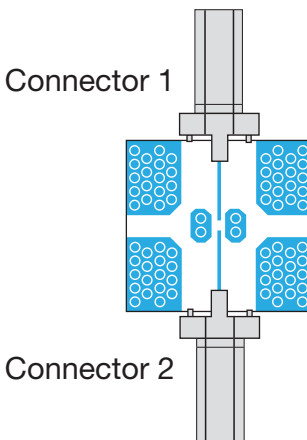

Calibration Jig

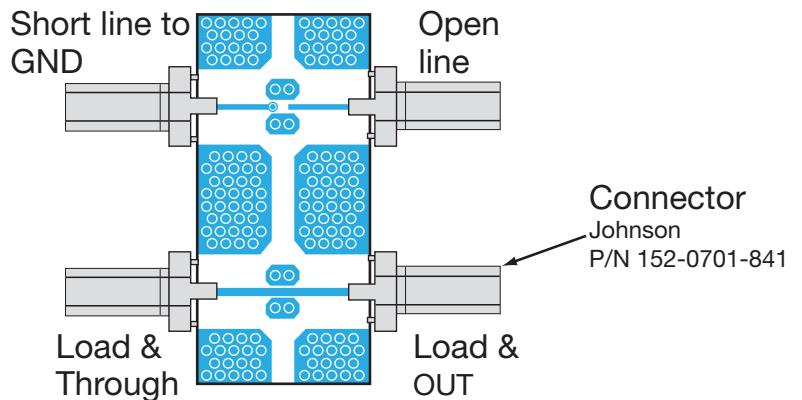



Компания «ЭлектроПласт» предлагает заключение долгосрочных отношений при поставках импортных электронных компонентов на взаимовыгодных условиях!

Наши преимущества:

- Оперативные поставки широкого спектра электронных компонентов отечественного и импортного производства напрямую от производителей и с крупнейших мировых складов;
- Поставка более 17-ти миллионов наименований электронных компонентов;
- Поставка сложных, дефицитных, либо снятых с производства позиций;
- Оперативные сроки поставки под заказ (от 5 рабочих дней);
- Экспресс доставка в любую точку России;
- Техническая поддержка проекта, помощь в подборе аналогов, поставка прототипов;
- Система менеджмента качества сертифицирована по Международному стандарту ISO 9001;
- Лицензия ФСБ на осуществление работ с использованием сведений, составляющих государственную тайну;
- Поставка специализированных компонентов (Xilinx, Altera, Analog Devices, Intersil, Interpoint, Microsemi, Aeroflex, Peregrine, Syfer, Eurofarad, Texas Instrument, Miteq, Cobham, E2V, MA-COM, Hittite, Mini-Circuits, General Dynamics и др.);

Помимо этого, одним из направлений компании «ЭлектроПласт» является направление «Источники питания». Мы предлагаем Вам помощь Конструкторского отдела:

- Подбор оптимального решения, техническое обоснование при выборе компонента;
- Подбор аналогов;
- Консультации по применению компонента;
- Поставка образцов и прототипов;
- Техническая поддержка проекта;
- Защита от снятия компонента с производства.



Как с нами связаться

Телефон: 8 (812) 309 58 32 (многоканальный)

Факс: 8 (812) 320-02-42

Электронная почта: org@eplast1.ru

Адрес: 198099, г. Санкт-Петербург, ул. Калинина, дом 2, корпус 4, литера А.