

E3S-C

Water- and Oil-resistant Photoelectric Sensor with Metal Housing Used for Long-range Sensing

- Excellent resistance against the water and oil. Easy application in locations with oil mist.
- Long-range sensing up to 30 m with Through-beam models.
- Shock resistance rated at 1,000m/s².
- Product lineup includes metal M12 pre-wired connector models.
- NPN/PNP selector switch output.









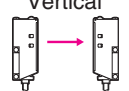

 Be sure to read *Safety Precautions* on page 6.

Ordering Information

Sensors (Refer to *Dimensions* on page 8.)

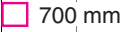
 Red light  Infrared light

Sensing method	Appearance	Connection method	Sensing distance	Model
Through-beam (Emitter + Receiver) *	Horizontal 	Pre-wired	 30 m	E3S-CT11 2M Emitter E3S-CT11-L 2M Receiver E3S-CT11-D 2M
		Pre-wired Connector (M12)		E3S-CT11-M1J 0.3M Emitter E3S-CT11-L-M1J 0.3M Receiver E3S-CT11-D-M1J 0.3M
	Vertical 	Pre-wired		E3S-CT61 2M Emitter E3S-CT61-L 2M Receiver E3S-CT61-D 2M
		Pre-wired Connector (M12)		E3S-CT61-M1J 0.3M Emitter E3S-CT61-L-M1J 0.3M Receiver E3S-CT61-D-M1J 0.3M
Retro-reflective	Horizontal 	Pre-wired	 3 m	E3S-CR11 2M
		Pre-wired Connector (M12)		E3S-CR11-M1J 0.3M
	Vertical 	Pre-wired		E3S-CR61 2M
		Pre-wired Connector (M12)		E3S-CR61-M1J 0.3M
Diffuse-reflective	Horizontal 	Pre-wired	 700 mm  2 m	E3S-CD11 2M
		Pre-wired Connector (M12)		E3S-CD12 2M
		Pre-wired		E3S-CD11-M1J 0.3M
		Pre-wired Connector (M12)		E3S-CD12-M1J 0.3M
	Vertical 	Pre-wired		E3S-CD61 2M
		Pre-wired Connector (M12)		E3S-CD62 2M
		Pre-wired		E3S-CD61-M1J 0.3M
		Pre-wired Connector (M12)		E3S-CD62-M1J 0.3M

* Through-beam Sensors are normally sold in sets that include both the Emitter and Receiver. Orders for individual Emitters and Receivers are accepted.

Accessories (Order Separately)

Slits (A Slit is not provided with Through-beam Sensors. Order a Slit separately if required.) (Refer to *Dimensions* on page 10.)

Slit width	Sensing distance	Minimum detectable object (typical)	Model	Quantity	Remarks
0.5 mm × 11 mm	1.8 m	0.5-mm dia.	E39-S61	1 set each for Emitter and Receiver (8 Slits total)	(Snap-in Long Slit) Can be used with the E3S-CT□1(-M1J) Through-beam Sensor. Refer to page 10.
1 mm × 11 mm	3.5 m	1-mm dia.			
2 mm × 11 mm	7 m	2-mm dia.			
4 mm × 11 mm	15 m	2.6-mm dia.			

Reflectors (Reflector required for Retroreflective Sensors)

A Reflector is provided with the E39-R1 Sensor. For other Sensors, order a reflector separately if required. (Refer to *Dimensions* on E39-L/F39-L/E39-S/E39-R.)

Name	Sensing distance (typical)	Model	Quantity	Remarks
Reflectors	3 m (rated value)	E39-R1	1	Provided with the E3S-CR□1 (-M1J) Retro-reflective Sensor.
	4 m	E39-R2	1	
Small Reflectors	1.5 m	E39-R3	1	---
	750 mm	E39-R4	1	---
Tape Reflectors	700 mm (50 mm)*	E39-RS1	1	Enables MSR function.
	1,100 mm (100 mm)*	E39-RS2	1	
	1,400 mm (100 mm)*	E39-RS3	1	

Note: 1. When using any reflector other than the provided one, use a sensing distance of approximately 0.7 times the typical value as a guide.

2. Refer to *Reflectors* on E39-L/F39-L/E39-S/E39-R for details.

* Values in parentheses indicate the minimum distance required between the Sensor and Reflector.

Mounting Brackets

Some Mounting Brackets are provided with the Sensor. Order other Mounting Brackets separately if required. (Refer to *Dimensions* on E39-L/F39-L/E39-S/E39-R.)



Appearance	Model	Quantity	Remarks
	E39-L102	1	Provided with Horizontal Models.
	E39-L103	1	Provided with Vertical Models.
	E39-L85	1	Mounting bracket for changing from E3S-□□□□42/44 to E3S-C Vertical Models.
	E39-L86	1	Mounting bracket for changing from E3S-□□□□43 to E3S-C Vertical Models.
	E39-L87	1	---

Note: 1. When using a Through-beam Sensor, order one Connector for the Receiver and one for the Emitter.

2. Refer to *Mounting Brackets* on E39-L/F39-L/E39-S/E39-R for details.

Sensor I/O Connectors

(Models with Pre-wired Connectors: A Connector is not provided with the Sensor. Be sure to order a Connector separately.) (Refer to *Dimensions* on XS2.)

Cable	Appearance	Cable type		Model
Standard	Straight 	2 m	3-wire	XS2F-D421-DC0-A
		5 m		XS2F-D421-GC0-A
	L-shape 	2 m		XS2F-D422-DC0-A
		5 m		XS2F-D422-GC0-A

Note: 1. When using a Through-beam Sensor, order one Connector for the Receiver and one for the Emitter.

2. For details on Sensor I/O Connectors and cables such as vibration-proof robot cables, refer to *Introduction to Sensor I/O Connectors*.

Ratings and Specifications

Item	Sensing method	Through-beam	Retro-reflective (with M.S.R. function) *1	Diffuse reflective	
	Model	Horizontal E3S-CT11(-M1J)	Horizontal E3S-CR11(-M1J)	Horizontal E3S-CD11(-M1J)	Horizontal E3S-CD12(-M1J)
		Vertical E3S-CT61(-M1J)	Vertical E3S-CR61(-M1J)	Vertical E3S-CD61(-M1J)	Vertical E3S-CD62(-M1J)
Sensing distance	30 m	3 m (when using E39-R1)	700 mm (300 × 300 mm white paper)	2 m (300 × 300 mm white paper)	
Standard sensing object	Opaque, 15-mm dia. min.	Opaque, 75-mm dia. min.	---		
Differential travel	---		20% max. of sensing distance		
Directional angle	Emitter and Receiver: 3° to 15°	3° to 10°	---		
Light source (wavelength)	Infrared LED (880 nm)	Red LED (700 nm)	Infrared LED (880 nm)		
Power supply voltage	10 to 30 VDC including 10% (p.p) ripple				
Current consumption	50 mA max. (Emitter 25 mA max. Receiver 25 mA max.)	40 mA max.			
Control output	Load power supply voltage: 30 VDC max. Load current: 100 mA max. (Residual voltage: NPN output: 1.2 V max., PNP output: 2.0 V max.) Open controller output (NPN/PNP selectable) Light-ON/Dark-ON selectable				
Protection circuits	Power supply reverse polari- ty circuit protection, Output short-circuit protection	Power supply reverse polarity protection, Output short-circuit protection, Mutual interference prevention			
Response time	Operate or reset: 1 ms max.			Operate or reset 2 ms max.	
Sensitivity adjustment	One-turn adjuster		Two-turn endless adjuster with an indicator		
Ambient illumination (Receiver side)	Incandescent lamp: 5,000 lx max. Sunlight: 10,000 lx max.				
Ambient temperature range	Operating: -25°C to 55°C, Storage: -40°C to 70°C (with no icing or condensation)				
Ambient humidity range	Operating: 35% to 85%, Storage: 35% to 95% (with no condensation)				
Insulation resistance	20 MΩ min. (at 500 VDC)				
Dielectric strength	1,000 VAC, 50/60 Hz for 1 min				
Vibration resistance	Destruction: 10 to 2,000 Hz, 1.5-mm double amplitude or 300 m/s ² for 0.5 hours each in X, Y, and Z directions				
Shock resistance	Destruction: 1,000 m/s ² 3 times each in X, Y, and Z directions				
Degree of protection	IEC 60529: IP67 (in-house standards: oil-resistant), NEMA: 6P (indoors only) *2				
Connection method	Pre-wired (standard cable length: 2 m) or Pre-wired M12 Connector (standard cable length: 0.3 m)				
Weight (packed state)	Approx. 270 g (Pre-wired cable) Approx. 230 g (Pre-wired Connector (M12))	Approx. 160 g (Pre-wired cable) Approx. 130 g (Pre-wired Connector (M12))	Approx. 150 g (Pre-wired cable) Approx. 110 g (Pre-wired Connector (M12))		
Material	Case	Zinc die-cast			
	Operation panel cover	PES (polyether sulfone)			
	Lens	Methacrylic resin			
	Mounting Bracket	Stainless steel (SUS304)			
Accessories	Mounting Bracket (with screws), Adjustment screwdriver, Instruction manual, and Reflector (only for Retro-reflective Sensors)				

*1. Refer to MSR function of Technical Guide (Technical version).

*2. NEMA: National Electrical Manufacturers Association

Engineering Data (Typical)

Parallel Operating Range

Through-beam
E3S-CT□ (-M1J)

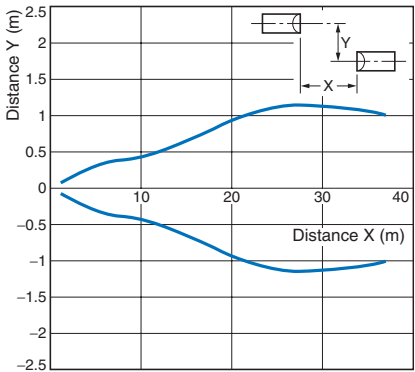

Through-beam
E3S-CT□ (-M1J) + E39-S61 Slit
(Order Separately)

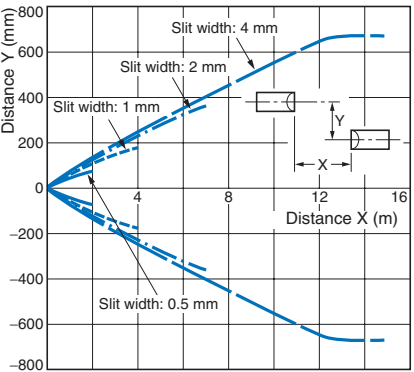

Retro-reflective
E3S-CR□1 (-M1J) + E39-R1 Reflector
(Provided)

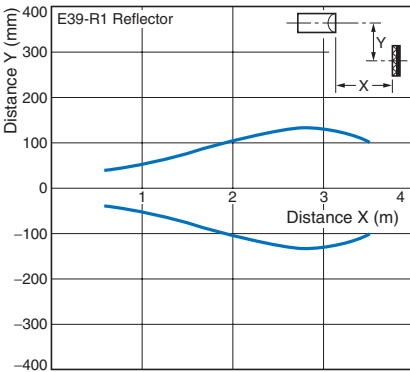

Operating Range

Diffuse-reflective
E3S-CD□□ (-M1J)

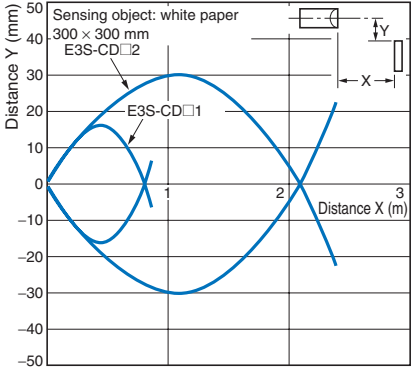

Excess Gain vs. Set Distance

Through-beam
E3S-CT□1 (-M1J)

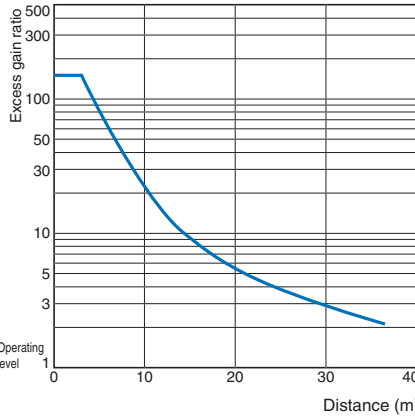

Retro-reflective
E3S-CR□1 (-M1J) + E39-R1 Reflector
(Provided)

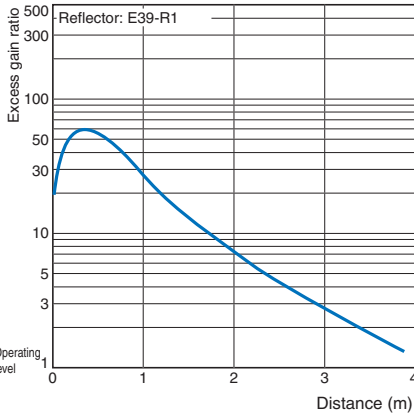

Diffuse-reflective
E3S-CD□□ (-M1J)

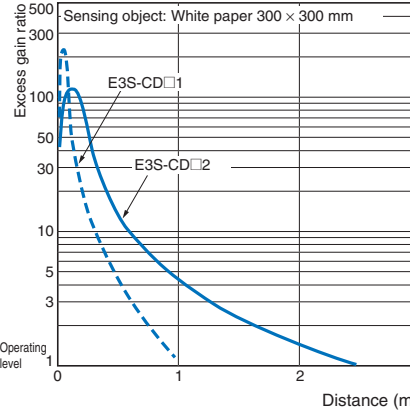

I/O Circuit Diagrams

NPN Output

Model	Operation mode	Timing charts	Operation selector	Output circuits
E3S-CT11(-M1J) * E3S-CT61(-M1J) * E3S-CR11(-M1J) E3S-CR61(-M1J) E3S-CD11(-M1J) E3S-CD12(-M1J) E3S-CD61(-M1J) E3S-CD62(-M1J)	Light-ON		L side (LIGHT ON)	<p>* Set the NPN or PNP selector to NPN.</p> <p>Connector Pin Arrangement</p> <p>Pin 2 is not used.</p>
	Dark-ON		D side (DARK ON)	<p>Connector Pin Arrangement</p> <p>Note: Pins 2 and 4 are not used.</p>

PNP Output

Model	Operation mode	Timing charts	Operation selector	Output circuits
E3S-CT11(-M1J) * E3S-CT61(-M1J) * E3S-CR11(-M1J) E3S-CR61(-M1J) E3S-CD11(-M1J) E3S-CD12(-M1J) E3S-CD61(-M1J) E3S-CD62(-M1J)	Light-ON		L side (LIGHT ON)	<p>* Set the NPN or PNP selector to PNP.</p> <p>Connector Pin Arrangement</p> <p>Pin 2 is not used.</p>
	Dark-ON		D side (DARK ON)	<p>Connector Pin Arrangement</p> <p>Note: Pins 2 and 4 are not used.</p>

* Models numbers for Through-beam Sensors (E3S-CT□1(-M1J)) are for sets that include both the Emitter and Receiver. The model number of the Emitter is expressed by adding "-L" to the set model number (example: E3S-CT11-L 2M), the model number of the Receiver, by adding "-D" (example: E3S-CT11-D 2M.) Refer to *Ordering Information* to confirm model numbers for Emitter and Receivers.

Plug (Sensor I/O Connector)



Classification	Conductor	Connector pin No.	Application
DC	Brown	1	Power supply (+V)
	—	2	—
	Blue	3	Power supply (0 V)
	Black	4	Output

Refer to *Introduction to Sensor I/O connectors* for details.

Note: Pin 2 is not used.

Nomenclature

Horizontal Model



Vertical Model



Note: The sensitivity adjuster on Through-beam and Retro-reflective Models is different.

- *1. Use the output selector to select the type of output transistor, NPN or PNP.
- *2. Use the operation selector to select the operation mode.

Safety Precautions

Refer to *Warranty and Limitations of Liability*.

⚠ WARNING

This product is not designed or rated for ensuring safety of persons either directly or indirectly. Do not use it for such purposes.



Precautions for Correct Use

Do not use the product in atmospheres or environments that exceed product ratings.

● Designing

Fuzzy Mutual Interference Prevention Function

If Reflective Sensors are installed side by side, each Sensor may be influenced by the light emitted from the other Sensors.

The fuzzy mutual interference prevention function of the E3S-C enables the E3S-C to monitor any light interference for a certain period before the E3S-C starts emitting light so that the E3S-C can retrieve the intensity and frequency of the light interference as data. Using this data, the E3S-C estimates with fuzzy inference the risk of the malfunctioning of the E3S-C and controls the timing of the E3S-C's light emission.

When the risk is low:

The E3S-C waits until there is no light interference and emits light.



When the risk is high:

The E3S-C emits light between each period of light interference.



● Wiring

Cable

- The E3S-C uses an oil-resistive cable to ensure oil resistivity.
- Do not allow the cable to be bent to a radius of less than 25 mm.

● Mounting

Mounting

- When mounting the E3S-C, do not hit the E3S-C with a hammer, or the E3S-C will lose watertightness.
- Use M4 screws to mount the E3S-C. The tightening torque of each screw must be 1.18 N·m maximum.

Mounting Bracket

- When mounting the E3S-C with the mounting bracket so that sensing objects will be in the direction of the mechanical axis, use the optical axis lock holes.
- If it is not possible to mount the E3S-C so that the sensing objects will be in the direction the mechanical axis, move the E3S-C upwards, downwards, to the left, or to the right and secure the E3S-C in the center of the range where the light indicator will be lit, at which time make sure that the stability indicator is lit.

Direct Mounting

Mount the E3S-C as shown in the following illustration.

Mounting with M4 Screws



Mounting with M3 Screws



Optical Axis Adjustment

Optical Lock Holes

By inserting screws into the optical axis lock holes, the Mounting Bracket will be in the direction of the optical axis of the E3S-C.

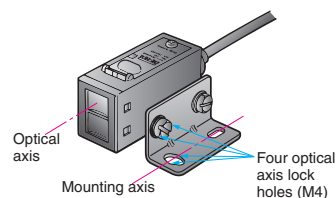

● Adjusting

Optical Axis of Through-beam Sensor

The E3S-C Through-beam Models incorporates two lenses, one of which will be used as shown in the following illustration. When using a Slit, the Slit must be on the side where the lens to be used is located.

Horizontal Model



Vertical Model



Water Resistance

To ensure the water resistance of the E3S-C, tighten the screws of the operation panel cover to a torque of 0.34 N·m to 0.54 N·m.

● Others

Oil and Chemical Resistance

- Although the E3S-C is oil-resistance, refer to the following table before using the E3S-C in places where oil may be sprayed on the E3S-C.
- Tests were carried out with the following oils and it was certified that the E3S-C resists these oils.

Oil	Product name	Kinematic viscosity (mm ² /s (cst)) at 40°C	PH
Lubricating oil	Velocite No.3	2.02	---
Water insoluble machining oil	Yushiron Oil No. 2 ac	Less than 10	
Water soluble machining oil	Yushiroken EC50T-3	---	7 to 9.5
	Yushiron Lubic HWC68		7 to 9.9
	Griton 1700D		7 to 9.2
	Yushiroken S50N		7 to 9.8

- Note: 1. The E3S-C maintained a minimum insulation resistance of 100 MΩ after the E3S-C was dipped in all the above oils at a temperature of 50°C for 240 hours.
2. When using the E3S-C in a place where an oil other than the ones listed above is sprayed on the E3S-C, refer to the above kinematic viscosity and pH values. The location may be suitable for the E3S-C if the kinematic viscosity and pH values of the oil are close to the above kinematic viscosity and pH values, but make sure that the oil does not contain any additive that may have a negative influence on the E3S-C.

Dimensions

Sensors

Through-beam (Horizontal)
E3S-CT11(-M1J)

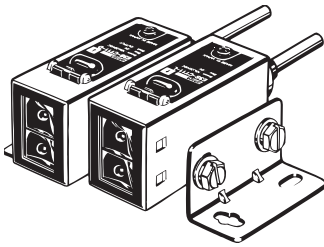

Emitter: E3S-CT□□-L
Receiver: E3S-CT□□-D

Pre-wired Connector (-M1J)



*1. The Mounting Bracket can be attached to side A.
*2. The Emitters for Through-beam Sensors only have the power indicator (red).
*3. The Emitter cable is 4-dia.vinyl-insulated round cable with 2 conductors (conductor cross section: 0.3 mm², insulator diameter: 1.3 mm) and a standard length of 2 m.

Note: Models numbers for Through-beam Sensors (E3S-CT11(-M1J)) are for sets that include both the Emitter and Receiver. The model number of the Emitter is expressed by adding "-L" to the set model number (example: E3S-CT11-L 2M), the model number of the Receiver, by adding "-D" (example: E3S-CT11-D 2M.) Refer to *Ordering Information* to confirm model numbers for Emitter and Receivers.

Through-beam (Vertical)

E3S-CT61(-M1J)

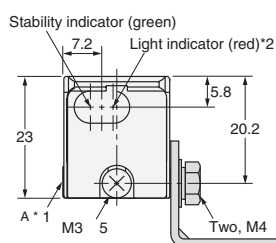
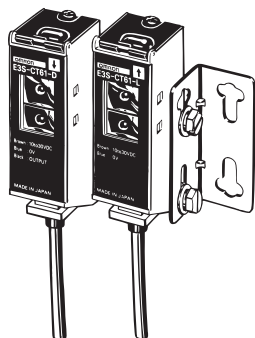

- *1. The Mounting Bracket can be attached to side A.
- *2. The Emitters for Through-beam Sensors only have the power indicator (red).
- *3. The Emitter cable is 4-dia. vinyl-insulated round cable with 2 conductors (conductor cross section: 0.3 mm², insulator diameter: 1.3 mm) and a standard length of 2 m.

Pre-wired Connector (-M1J)

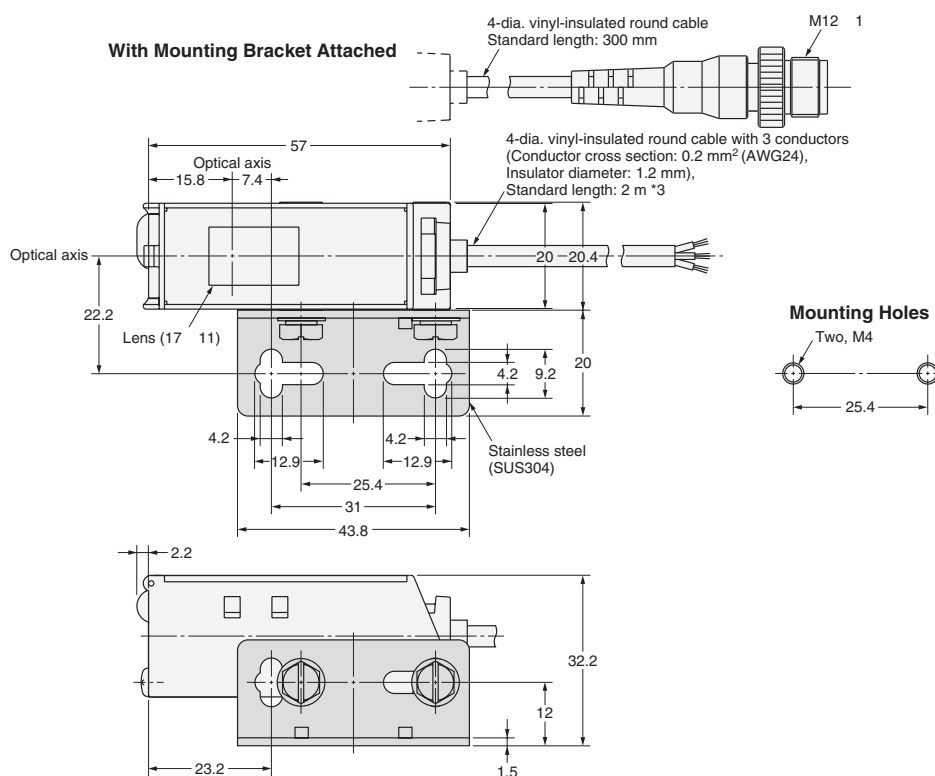

Retro-/Diffuse-reflective (Horizontal)

E3S-CR11(-M1J)

E3S-CD11(-M1J)

E3S-CD12(-M1J)

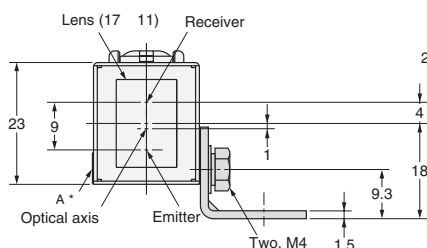

*The Mounting Bracket can be attached to side A.

Pre-wired Connector (-M1J)

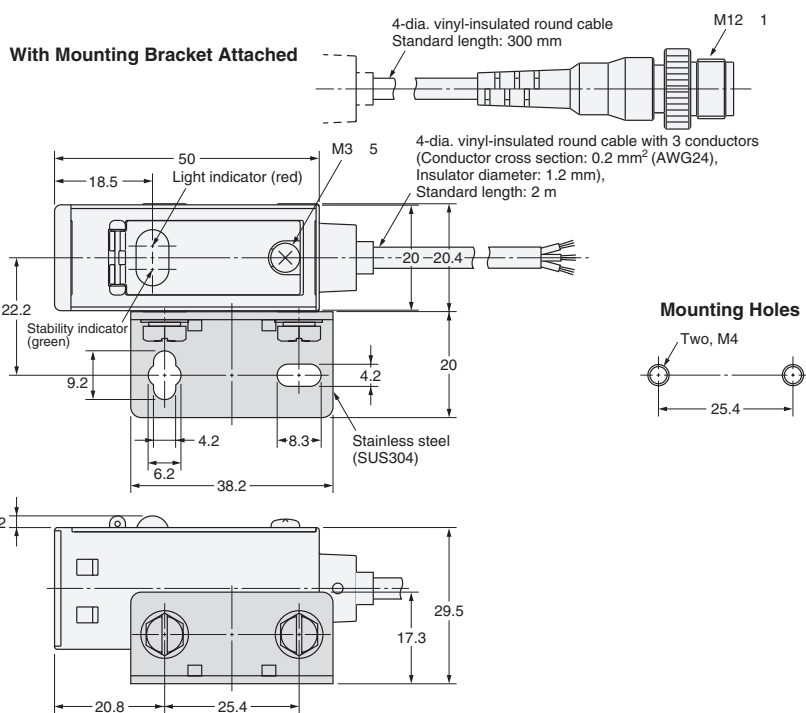

Note: Model numbers for Through-beam Sensors (E3S-CT61(-M1J)) are for sets that include both the Emitter and Receiver. The model number of the Emitter is expressed by adding "-L" to the set model number (example: E3S-CT61-L 2M), the model number of the Receiver, by adding "-D" (example: E3S-CT61-D 2M.) Refer to *Ordering Information* to confirm model numbers for Emitter and Receivers.

Retro-/Diffuse-reflective (Vertical)

E3S-CR61(-M1J)
E3S-CD61(-M1J)
E3S-CD62(-M1J)

Pre-wired Connector (-M1J)



*The Mounting Bracket can be attached to side A.

Accessories (Order Separately)

Snap-in Long Slit (For Through-beam Models)

E39-S61

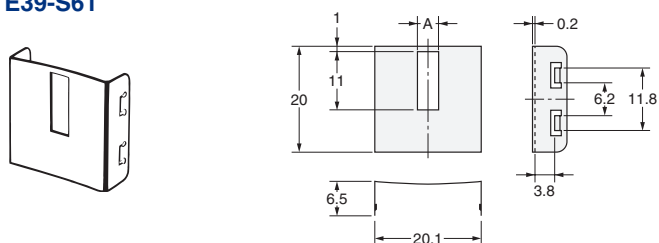

Dimension A (mm)	Material	Quantity
0.5	Stainless steel	1 set each for Emitter/Receiver (8 Slits total)
1		
2		
4		

Reflectors

Refer to E39-L/F39-L/E39-S/E39-R for details.

Mounting Brackets

Refer to E39-L/F39-L/E39-S/E39-R for details.

Read and Understand This Catalog

Please read and understand this catalog before purchasing the products. Please consult your OMRON representative if you have any questions or comments.

Warranty and Limitations of Liability

WARRANTY

OMRON's exclusive warranty is that the products are free from defects in materials and workmanship for a period of one year (or other period if specified) from date of sale by OMRON.

OMRON MAKES NO WARRANTY OR REPRESENTATION, EXPRESS OR IMPLIED, REGARDING NON-INFRINGEMENT, MERCHANTABILITY, OR FITNESS FOR PARTICULAR PURPOSE OF THE PRODUCTS. ANY BUYER OR USER ACKNOWLEDGES THAT THE BUYER OR USER ALONE HAS DETERMINED THAT THE PRODUCTS WILL SUITABLY MEET THE REQUIREMENTS OF THEIR INTENDED USE. OMRON DISCLAIMS ALL OTHER WARRANTIES, EXPRESS OR IMPLIED.

LIMITATIONS OF LIABILITY

OMRON SHALL NOT BE RESPONSIBLE FOR SPECIAL, INDIRECT, OR CONSEQUENTIAL DAMAGES, LOSS OF PROFITS OR COMMERCIAL LOSS IN ANY WAY CONNECTED WITH THE PRODUCTS, WHETHER SUCH CLAIM IS BASED ON CONTRACT, WARRANTY, NEGLIGENCE, OR STRICT LIABILITY.

In no event shall the responsibility of OMRON for any act exceed the individual price of the product on which liability is asserted.

IN NO EVENT SHALL OMRON BE RESPONSIBLE FOR WARRANTY, REPAIR, OR OTHER CLAIMS REGARDING THE PRODUCTS UNLESS OMRON'S ANALYSIS CONFIRMS THAT THE PRODUCTS WERE PROPERLY HANDLED, STORED, INSTALLED, AND MAINTAINED AND NOT SUBJECT TO CONTAMINATION, ABUSE, MISUSE, OR INAPPROPRIATE MODIFICATION OR REPAIR.

Application Considerations

SUITABILITY FOR USE

OMRON shall not be responsible for conformity with any standards, codes, or regulations that apply to the combination of products in the customer's application or use of the products.

At the customer's request, OMRON will provide applicable third party certification documents identifying ratings and limitations of use that apply to the products. This information by itself is not sufficient for a complete determination of the suitability of the products in combination with the end product, machine, system, or other application or use.

The following are some examples of applications for which particular attention must be given. This is not intended to be an exhaustive list of all possible uses of the products, nor is it intended to imply that the uses listed may be suitable for the products:

- Outdoor use, uses involving potential chemical contamination or electrical interference, or conditions or uses not described in this catalog.
- Nuclear energy control systems, combustion systems, railroad systems, aviation systems, medical equipment, amusement machines, vehicles, safety equipment, and installations subject to separate industry or government regulations.
- Systems, machines, and equipment that could present a risk to life or property.

Please know and observe all prohibitions of use applicable to the products.

NEVER USE THE PRODUCTS FOR AN APPLICATION INVOLVING SERIOUS RISK TO LIFE OR PROPERTY WITHOUT ENSURING THAT THE SYSTEM AS A WHOLE HAS BEEN DESIGNED TO ADDRESS THE RISKS, AND THAT THE OMRON PRODUCTS ARE PROPERLY RATED AND INSTALLED FOR THE INTENDED USE WITHIN THE OVERALL EQUIPMENT OR SYSTEM.

PROGRAMMABLE PRODUCTS

OMRON shall not be responsible for the user's programming of a programmable product, or any consequence thereof.

Disclaimers

CHANGE IN SPECIFICATIONS

Product specifications and accessories may be changed at any time based on improvements and other reasons.

It is our practice to change model numbers when published ratings or features are changed, or when significant construction changes are made. However, some specifications of the products may be changed without any notice. When in doubt, special model numbers may be assigned to fix or establish key specifications for your application on your request. Please consult with your OMRON representative at any time to confirm actual specifications of purchased products.

DIMENSIONS AND WEIGHTS

Dimensions and weights are nominal and are not to be used for manufacturing purposes, even when tolerances are shown.

PERFORMANCE DATA

Performance data given in this catalog is provided as a guide for the user in determining suitability and does not constitute a warranty. It may represent the result of OMRON's test conditions, and the users must correlate it to actual application requirements. Actual performance is subject to the OMRON Warranty and Limitations of Liability.

ERRORS AND OMISSIONS

The information in this document has been carefully checked and is believed to be accurate; however, no responsibility is assumed for clerical, typographical, or proofreading errors, or omissions.

2010.9

In the interest of product improvement, specifications are subject to change without notice.

OMRON Corporation
Industrial Automation Company

<http://www.ia.omron.com/>

(c)Copyright OMRON Corporation 2010 All Right Reserved.



Компания «ЭлектроПласт» предлагает заключение долгосрочных отношений при поставках импортных электронных компонентов на взаимовыгодных условиях!

Наши преимущества:

- Оперативные поставки широкого спектра электронных компонентов отечественного и импортного производства напрямую от производителей и с крупнейших мировых складов;
- Поставка более 17-ти миллионов наименований электронных компонентов;
- Поставка сложных, дефицитных, либо снятых с производства позиций;
- Оперативные сроки поставки под заказ (от 5 рабочих дней);
- Экспресс доставка в любую точку России;
- Техническая поддержка проекта, помощь в подборе аналогов, поставка прототипов;
- Система менеджмента качества сертифицирована по Международному стандарту ISO 9001;
- Лицензия ФСБ на осуществление работ с использованием сведений, составляющих государственную тайну;
- Поставка специализированных компонентов (Xilinx, Altera, Analog Devices, Intersil, Interpoint, Microsemi, Aeroflex, Peregrine, Syfer, Eurofarad, Texas Instrument, Miteq, Cobham, E2V, MA-COM, Hittite, Mini-Circuits, General Dynamics и др.);

Помимо этого, одним из направлений компании «ЭлектроПласт» является направление «Источники питания». Мы предлагаем Вам помощь Конструкторского отдела:

- Подбор оптимального решения, техническое обоснование при выборе компонента;
- Подбор аналогов;
- Консультации по применению компонента;
- Поставка образцов и прототипов;
- Техническая поддержка проекта;
- Защита от снятия компонента с производства.



Как с нами связаться

Телефон: 8 (812) 309 58 32 (многоканальный)

Факс: 8 (812) 320-02-42

Электронная почта: org@eplast1.ru

Адрес: 198099, г. Санкт-Петербург, ул. Калинина, дом 2, корпус 4, литера А.