

SUPPLEMENT

Catalog

2014

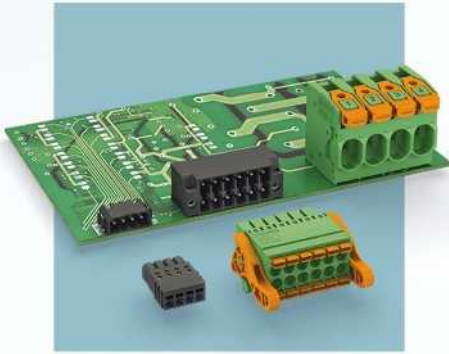

The Phoenix Contact catalog system



1 PCB connection technology and electronics housing

- PCB terminal blocks and plug connectors
- Electronics housing



2 Connection technology for field devices

- Plug connectors
- Cables and connectors



3 Modular terminal blocks

- Modular terminal blocks



4 Sensor/actuator cabling and industrial plug connectors

- Sensor/actuator cabling
- Cables and connectors
- Plug connectors



5 Marking systems, tools, and mounting material

- Marking and labeling
- Tools
- Installation and mounting material



6 Surge protection and power supply units

- Lightning monitoring system
- Surge protection and interference filters
- Power supply units and UPS
- Protective devices



7 Interface technology and switching devices

- Electronic switching devices and motor control
- Measurement and control technology • Monitoring and signaling
- Relay modules • System cabling for controllers



8 Control technology, I/O systems and automation infrastructure

- Ethernet networks • Functional safety • HMIs and industrial PCs • I/O systems
- Industrial lighting and signaling • Industrial communication technology
- Fieldbus components and systems • Wireless data communication
- Process infrastructure • Software • Controllers

| | | |
|---|---|-----------|
|  | 2 PCB connection technology and electronics housing | Catalog 1 |
|  | 40 Connection technology for field devices | Catalog 2 |
|  | 86 Modular terminal blocks | Catalog 3 |
|  | 174 Sensor/actuator cabling and industrial connectors | Catalog 4 |
|  | 240 Marking systems, tools, and mounting material | Catalog 5 |
|  | 302 Surge protection and power supplies | Catalog 6 |
|  | 322 Interface technology and switching devices | Catalog 7 |
|  | 374 Control technology, I/O systems, and automation infrastructure | Catalog 8 |
| | 434 Index | |

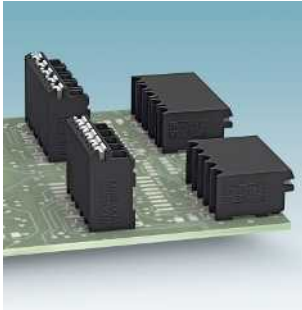

SMD PCB terminal blocks with push-in spring connection up to 1.5 mm², 3.5 and 3.81 mm pitch
SPT-SMD 1,5/ ...-H-... R32 Page 7
SPT-SMD 1,5/ ...-V-... R32 Page 7

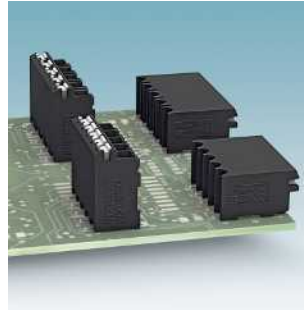

SMD PCB terminal blocks with push-in spring connection up to 1.5 mm², 5.0 and 5.08 mm pitch
SPT-SMD 1,5/ ...-H-5,0 R32 Page 9
SPT-SMD 1,5/ ...-V-5,0 R32 Page 9



THR PCB terminal blocks with push-in spring connection up to 1.5 mm², 3.5 and 3.81 mm pitch
SPT-THR 1,5/ ...-H-3,5 P26 Page 10
SPT-THR 1,5/...-V-3,5 P26 Page 11

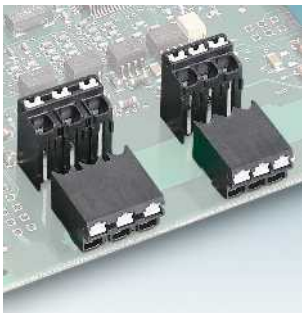

THR PCB terminal blocks with push-in spring connection up to 1.5 mm², 5.0 and 5.08 mm pitch
SPT-THR 1,5/ ...-H-5,0 P26 Page 12
SPT-THR 1,5/ ...-V-5,0 P26 Page 13

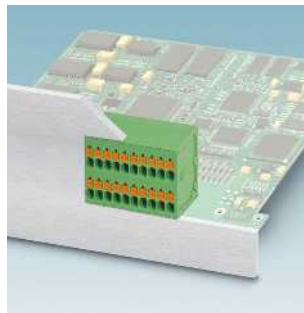

Double-row PCB terminal block with push-in spring connection up to 1.5 mm², 3.5 mm pitch
SPTD 1,5/ ...-H-3,5 Page 15

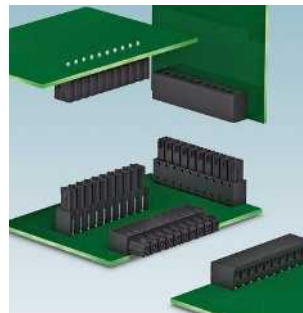

Inverted headers for reflow processes, 3.5 mm pitch
IMC 1,5/ ...-G-3,5 P20 THR Page 16
IMCV 1,5/ ...-G-3,5 P20 THR Page 17

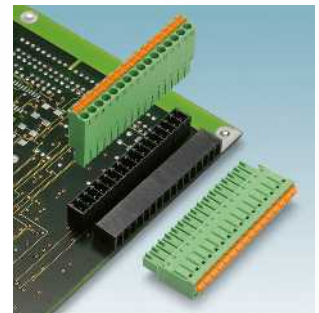

Single-level headers, 13 to 20-pos., for reflow processes, 3.81 mm pitch
MC 1,5/...-G-3,81 P20 THR Page 18
MCV 1,5/...-G-3,81 P20 THR Page 19



Taped single-level headers, 13 to 20-pos., for reflow processes, 3.81 mm pitch
MC 1,5/...-G-3,81 P20 THRR... Page 20
MCV 1,5/...-G-3,81 P20 THRR... Page 21

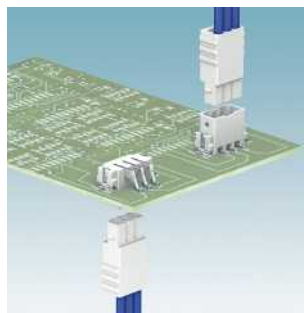

Plugs with push-in spring connection up to 0.75 mm², 2.5 mm pitch
PTSM 0,5/ ...-HV-2,5-SMD WH R32 Page 23
PTSM 0,5/ ...-HTB-2,5-SMD WH R32 Page 23

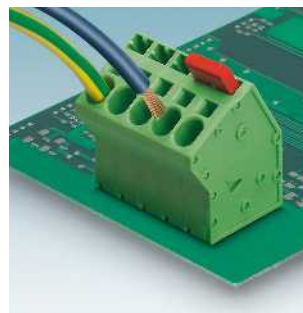

Angled PCB terminal blocks with push-in spring connection up to 6 mm², 7.5 mm pitch
SPTA 5/ ...-7,5-ZB Page 25

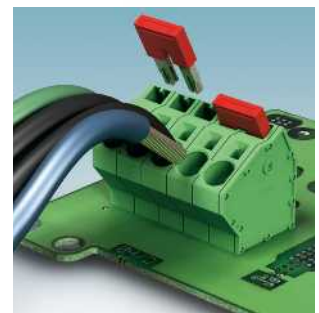

Angled PCB terminal blocks with push-in spring connection up to 6 mm², 10 mm pitch
SPTA 16/ ...-10,0-ZB Page 27

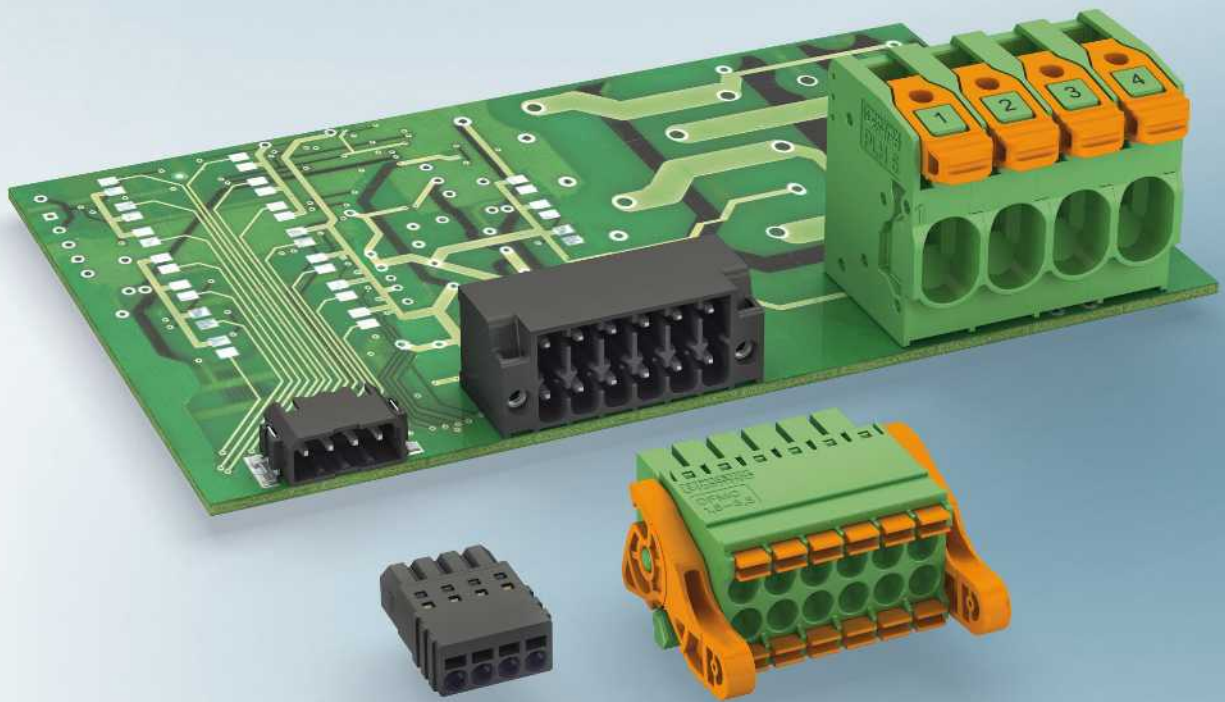

Feed-through terminal blocks with push-in spring connection up to 16 mm² for high-current applications

PWO 16-UW

Page 29

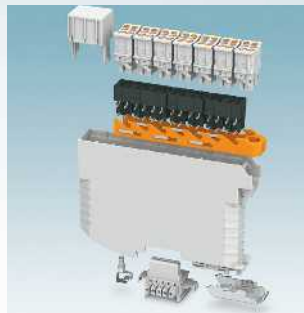

ME-IO electronics housing with front connection

**ME-IO 18, 8....
HSC...**

Page 30
Page 30



PCO... power connector for ME MAX housing

**PCO-L KMGY
PBR 42A...**

Page 38
Page 38



ME TBUS 4P1S and ME TBUS ADAPTER for ME and ME MAX housing

**METBUS 1,5/4P1S KMGY
METBUS ADAPTER KMGY**

Page 39
Page 39



SMD- Surface Mount Device

Generally the term SMD or SMT (surface mount technology) refers to the dominant production method currently used for assemblies in electronics production. In this case solder paste is applied to the contact surfaces of the PCB. The surface contacts of the component are dipped in this paste and soldered by means of the reflow soldering process.

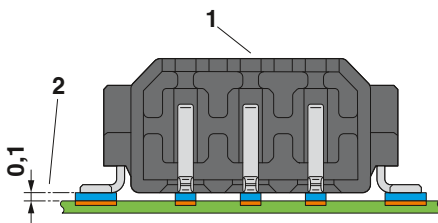

Properties of SMD/THR components in the reflow process

- Resistance to high temperatures
- Suction areas (1) for automatic PCB assembly by means of pick-and-place
- Stability in the case of mechanical loads
- Coplanarity (2) (evenness) of the SMD contacts

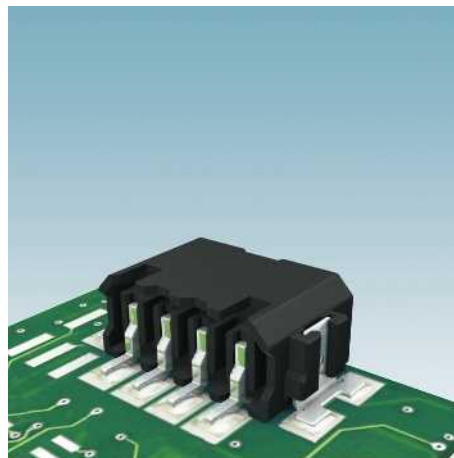

PTSM 0,5...SMD

In addition to the SMD contacts, the components have anchor metal on the side. This ensures that the insertion and withdrawal force of the plugs does not overload the contact points.

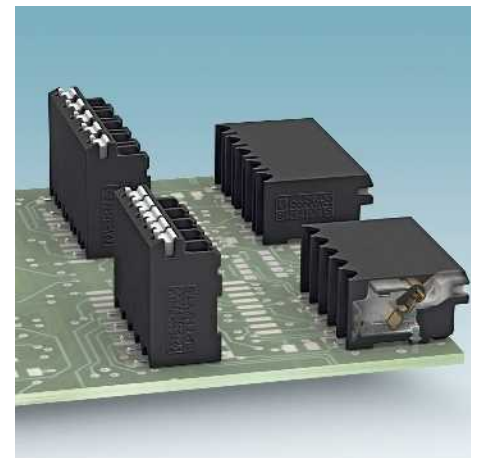

SPT-SMD 1,5...

Additional solder pins on the side position the component on the PCB and prevent it moving during the process. Moreover, they absorb the force when the conductors are connected.



The qualification of the SMD connectors is based on IPC/JEDEC J-STD020 indicating the MSL (Moisture Sensitive Level) and the max. processing temperatures. The SMD/THR components meet MSL 1 or 2 which means that dry bag packaging is not required.



The standard tape width for tape-on-reel packaging supports automatic PCB assembly in pick-and-place applications.

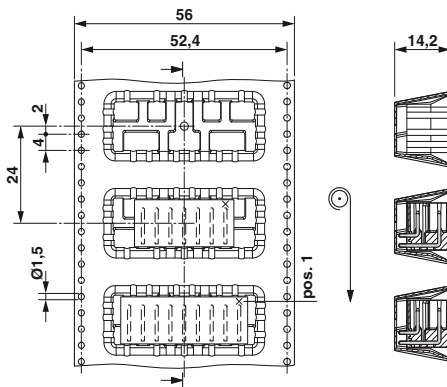

Dimensional drawings of tape reels and suction areas and pads can be found online at phoenixcontact.net/products.

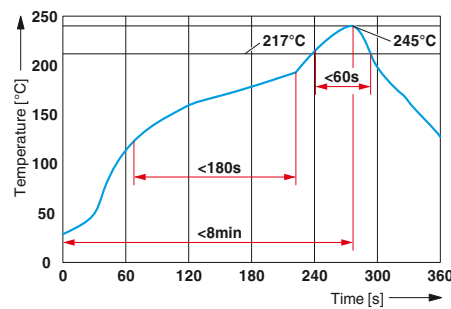

Reflow soldering

The reflow process and the required temperature profiles are described in SMD standards DIN EN 61760-1 or also IEC 60068-2-58. The profiles described are usually used for test purposes, but are also recommended for the application.

PCB terminal blocks with 2.54 to 7.62 mm pitch

SMD PCB terminal blocks with push-in spring connection up to 1.5 mm²







- Push-in direct plug-in technology for solid and stranded conductors
- Suitable for use in SMD processes
- Horizontal and vertical design with a 3.5 mm and 3.81 mm pitch
- High stability due to anchor pins or two soldering pads per position
- Supplied in taped packaging according to IEC 60286-3 for automatic assembly
- Touch connection for voltage testing using a 1 mm Ø test pin

Notes:

Dimensional drawings of tape reels and place pads can be found online at phoenixcontact.net/products.

1) Current carrying capacity curve available on request.

For accessories, see Catalog 1

| For all types | Type | Page |
|---|--|------|
|  | Screwdriver SZS 0,4 x 2,5 Order No. 1205037 | |
|  | Marker cards SK 3,5/2,8 or SK 3,81/2,8 | 796 |
|  | Ferrules with and without plastic sleeve | 834 |
|  | Crimping pliers for 0.25 to 6 mm ² CRIMPFOX 6 Order No. 1212034 | |
|  | Test plug MPS-MT 1-S Order No. 1944372 | 831 |

Technical data

| | |
|---|---|
| Technical data in accordance to IEC / DIN VDE | |
| Rated current / conductor cross section | [A] / [mm ²] |
| Rated insulation voltage for pollution degree 2 | [V] |
| Pitch | [mm] |
| Connection capacity | |
| Solid / stranded | [mm ²] / [mm ²] / AWG |
| Stranded with ferrules without plastic sleeve | [mm ²] |
| Stranded with ferrules with plastic sleeve | [mm ²] |
| Insulation coordination | |
| Surge voltage category / pollution degree | |
| Rated insulation voltage | [V] |
| Rated surge voltage | [kV] |
| Approval data (UL/CUL) | Use Group |
| Nominal voltage | [V] |
| Nominal current | [A] |
| Connection capacity AWG | AWG |
| Approval data (CSA) | Use Group |
| Nominal voltage | [V] |
| Nominal current | [A] |
| Connection capacity AWG | AWG |
| General data | |
| Stripping length | [mm] |
| Type of insulation material / insulation material group | |
| Inflammability class according to UL 94 | |
| Drill hole diameter / pin dimensions | [mm] |

SPT-SMD 1,5/...H...R...

| | | | | | |
|---------------------------------|---------|--------|---------------------------------|---------|--------|
| 13.5 ¹⁾ / 1.5 | | | 13.5 ¹⁾ / 1.5 | | |
| 160 | | | 160 | | |
| 3.5 / 3.81 | | | 3.5 / 3.81 | | |
| 0.2 - 1.5 / 0.2 - 1.5 / 24 - 16 | | | 0.2 - 1.5 / 0.2 - 1.5 / 24 - 16 | | |
| 0.2 - 1.5 | | | 0.2 - 1.5 | | |
| 0.2 - 0.75 | | | 0.2 - 0.75 | | |
| III / 3 | III / 2 | II / 2 | III / 3 | III / 2 | II / 2 |
| 160 | 160 | 320 | 160 | 160 | 320 |
| 2.5 | 2.5 | 2.5 | 2.5 | 2.5 | 2.5 |
| B | C | D | B | C | D |
| - | - | - | - | - | - |
| - | - | - | - | - | - |
| - | - | - | - | - | - |
| B | C | D | B | C | D |
| - | - | - | - | - | - |
| - | - | - | - | - | - |
| - | - | - | - | - | - |
| 8 | | | 8 | | |
| LCP / IIIa | | | LCP / IIIa | | |
| V0 | | | V0 | | |
| 1.1 / 0.7 x 0.3 | | | 1.1 / 0.7 x 0.3 | | |

SPT-SMD 1,5/...V...R...

| No. of pos. | Dim. a [mm] |
|-------------|-------------|
| 2 | 3.50 |
| 3 | 7.00 |
| 4 | 10.50 |
| 5 | 14.00 |
| 6 | 17.50 |
| 7 | 21.00 |
| 8 | 24.50 |
| 9 | 28.00 |
| 10 | 31.50 |
| 11 | 35.00 |
| 12 | 38.50 |
| 2 | 3.81 |
| 3 | 7.62 |
| 4 | 11.43 |
| 5 | 15.24 |
| 6 | 19.05 |
| 7 | 22.86 |
| 8 | 26.67 |
| 9 | 30.48 |
| 10 | 34.29 |
| 11 | 38.10 |
| 12 | 41.91 |



Taped PCB terminal block, connection direction horizontal to the PCB



Taped PCB terminal block, connection direction vertical to the PCB

Dimensional drawing



Dimensional drawing

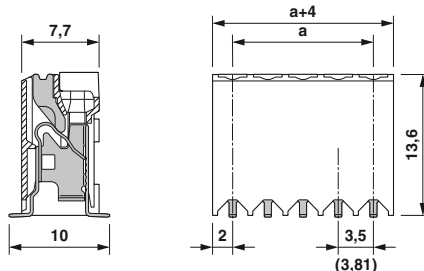

Drilling diagram



Drilling diagram



Ordering data

| Type | Order No. | Pcs. / Pkt. |
|-----------------------------|-----------|-------------|
| Pitch 3.5 mm, color: black | | |
| SPT-SMD 1,5/ 2-H-3,5 R24 | 1824527 | 300 |
| SPT-SMD 1,5/ 3-H-3,5 R24 | 1824530 | 300 |
| SPT-SMD 1,5/ 4-H-3,5 R44 | 1824543 | 300 |
| SPT-SMD 1,5/ 5-H-3,5 R44 | 1824556 | 300 |
| SPT-SMD 1,5/ 6-H-3,5 R44 | 1824569 | 300 |
| SPT-SMD 1,5/ 7-H-3,5 R44 | 1824572 | 300 |
| SPT-SMD 1,5/ 8-H-3,5 R72 | 1824585 | 300 |
| SPT-SMD 1,5/ 9-H-3,5 R72 | 1824598 | 300 |
| SPT-SMD 1,5/10-H-3,5 R72 | 1824608 | 300 |
| SPT-SMD 1,5/11-H-3,5 R72 | 1824611 | 300 |
| SPT-SMD 1,5/12-H-3,5 R72 | 1824624 | 300 |
| 3.81 mm pitch, color: black | | |
| SPT-SMD 1,5/ 2-H-3,81 R24 | 1824637 | 300 |
| SPT-SMD 1,5/ 3-H-3,81 R24 | 1824640 | 300 |
| SPT-SMD 1,5/ 4-H-3,81 R44 | 1824653 | 300 |
| SPT-SMD 1,5/ 5-H-3,81 R44 | 1824666 | 300 |
| SPT-SMD 1,5/ 6-H-3,81 R44 | 1824679 | 300 |
| SPT-SMD 1,5/ 7-H-3,81 R44 | 1824682 | 300 |
| SPT-SMD 1,5/ 8-H-3,81 R72 | 1824695 | 300 |
| SPT-SMD 1,5/ 9-H-3,81 R72 | 1824705 | 300 |
| SPT-SMD 1,5/10-H-3,81 R72 | 1824718 | 300 |
| SPT-SMD 1,5/11-H-3,81 R72 | 1824721 | 300 |
| SPT-SMD 1,5/12-H-3,81 R72 | 1824734 | 300 |

Ordering data

| Type | Order No. | Pcs. / Pkt. |
|-----------------------------|-----------|-------------|
| Pitch 3.5 mm, color: black | | |
| SPT-SMD 1,5/ 2-V-3,5 R24 | 1824080 | 200 |
| SPT-SMD 1,5/ 3-V-3,5 R32 | 1824093 | 200 |
| SPT-SMD 1,5/ 4-V-3,5 R44 | 1824103 | 200 |
| SPT-SMD 1,5/ 5-V-3,5 R44 | 1824116 | 200 |
| SPT-SMD 1,5/ 6-V-3,5 R44 | 1824129 | 200 |
| SPT-SMD 1,5/ 7-V-3,5 R44 | 1824132 | 200 |
| SPT-SMD 1,5/ 8-V-3,5 R72 | 1824145 | 200 |
| SPT-SMD 1,5/ 9-V-3,5 R72 | 1824158 | 200 |
| SPT-SMD 1,5/10-V-3,5 R72 | 1824161 | 200 |
| SPT-SMD 1,5/11-V-3,5 R72 | 1824174 | 200 |
| SPT-SMD 1,5/12-V-3,5 R72 | 1824187 | 200 |
| 3.81 mm pitch, color: black | | |
| SPT-SMD 1,5/ 2-V-3,81 R24 | 1824190 | 200 |
| SPT-SMD 1,5/ 3-V-3,81 R32 | 1824200 | 200 |
| SPT-SMD 1,5/ 4-V-3,81 R44 | 1824213 | 200 |
| SPT-SMD 1,5/ 5-V-3,81 R44 | 1824226 | 200 |
| SPT-SMD 1,5/ 6-V-3,81 R44 | 1824239 | 200 |
| SPT-SMD 1,5/ 7-V-3,81 R44 | 1824242 | 200 |
| SPT-SMD 1,5/ 8-V-3,81 R72 | 1824255 | 200 |
| SPT-SMD 1,5/ 9-V-3,81 R72 | 1824268 | 200 |
| SPT-SMD 1,5/10-V-3,81 R72 | 1824271 | 200 |
| SPT-SMD 1,5/11-V-3,81 R72 | 1824284 | 200 |
| SPT-SMD 1,5/12-V-3,81 R72 | 1824297 | 200 |

PCB terminal blocks with 2.54 to 7.62 mm pitch

SMD PCB terminal blocks with push-in spring connection up to 1.5 mm²







- Push-in direct plug-in technology for solid and stranded conductors
- Suitable for use in SMD processes
- Horizontal and vertical design with a 5.0 mm and 5.08 mm pitch
- High stability due to anchor pins or two soldering pads per position
- Supplied in taped packaging according to IEC 60286-3 for automatic assembly
- Touch connection for voltage testing using a 1 mm Ø test pin

Notes:

Dimensional drawings of tape reels and place pads can be found online at phoenixcontact.net/products.

1) Current carrying capacity curve available on request.

For accessories, see Catalog 1

| For all types | Type | Page |
|---|--|------|
|  | Screwdriver SZS 0,4 x 2,5 Order No. 1205037 | |
|  | Marker cards SK 5/3,8 or SK 5,08/3,8 | 798 |
|  | Ferrules with and without plastic sleeve | 834 |
|  | Crimping pliers for 0.25 to 6 mm ² CRIMPFOX 6 Order No. 1212034 | |
|  | Test plug MPS-MT 1-S Order No. 1944372 | 831 |

Technical data

| | |
|---|---|
| Technical data in accordance to IEC / DIN VDE | |
| Rated current / conductor cross section | [A] / [mm ²] |
| Rated insulation voltage for pollution degree 2 | [V] |
| Pitch | [mm] |
| Connection capacity | |
| Solid / stranded | [mm ²] / [mm ²] / AWG |
| Stranded with ferrules without plastic sleeve | [mm ²] |
| Stranded with ferrules with plastic sleeve | [mm ²] |
| Insulation coordination | |
| Surge voltage category / pollution degree | |
| Rated insulation voltage | [V] |
| Rated surge voltage | [kV] |
| Approval data (UL/CUL) | Use Group |
| Nominal voltage | [V] |
| Nominal current | [A] |
| Connection capacity AWG | AWG |
| Approval data (CSA) | Use Group |
| Nominal voltage | [V] |
| Nominal current | [A] |
| Connection capacity AWG | AWG |
| General data | |
| Stripping length | [mm] |
| Type of insulation material / insulation material group | |
| Inflammability class according to UL 94 | |
| Drill hole diameter / pin dimensions | [mm] |

SPT-SMD 1,5/...H..R

| | | |
|---------------------------------|---------|--------|
| 13.5 ¹⁾ / 1.5 | | |
| 320 | | |
| 5 / 5.08 | | |
| 0.2 - 1.5 / 0.2 - 1.5 / 24 - 16 | | |
| 0.2 - 1.5 | | |
| 0.2 - 0.75 | | |
| III / 3 | III / 2 | II / 2 |
| 250 | 320 | 500 |
| 4 | 4 | 4 |
| B | C | D |
| - | - | - |
| - | - | - |
| - | - | - |
| B | C | D |
| - | - | - |
| - | - | - |
| - | - | - |
| 8 | | |
| LCP / IIIa | | |
| V0 | | |
| 1.1 / 0.7 x 0.3 mm | | |

SPT-SMD 1,5/...V...R...

| | | |
|---------------------------------|---------|--------|
| 13.5 ¹⁾ / 1.5 | | |
| 320 | | |
| 5 / 5.08 | | |
| 0.2 - 1.5 / 0.2 - 1.5 / 24 - 16 | | |
| 0.2 - 1.5 | | |
| 0.2 - 0.75 | | |
| III / 3 | III / 2 | II / 2 |
| 250 | 320 | 500 |
| 4 | 4 | 4 |
| B | C | D |
| - | - | - |
| - | - | - |
| - | - | - |
| B | C | D |
| - | - | - |
| - | - | - |
| - | - | - |
| 8 | | |
| LCP / IIIa | | |
| V0 | | |
| 1.1 / 0.7 x 0.3 mm | | |

| No. of pos. | Dim. a [mm] |
|-------------|-------------|
| 2 | 5.00 |
| 3 | 10.00 |
| 4 | 15.00 |
| 5 | 20.00 |
| 6 | 25.00 |
| 7 | 30.00 |
| 8 | 35.00 |
| 9 | 40.00 |
| 10 | 45.00 |
| 11 | 50.00 |
| 12 | 55.00 |
| | |
| 2 | 5.08 |
| 3 | 10.16 |
| 4 | 15.24 |
| 5 | 20.32 |
| 6 | 25.40 |
| 7 | 30.48 |
| 8 | 35.56 |
| 9 | 40.64 |
| 10 | 45.72 |
| 11 | 50.80 |
| 12 | 55.88 |



Taped PCB terminal block, connection direction horizontal to the PCB



Taped PCB terminal block, connection direction vertical to the PCB

Dimensional drawing

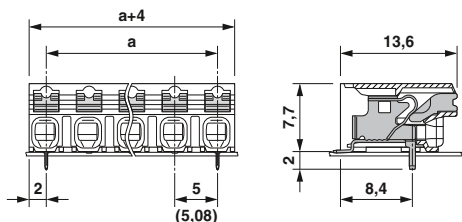

Dimensional drawing

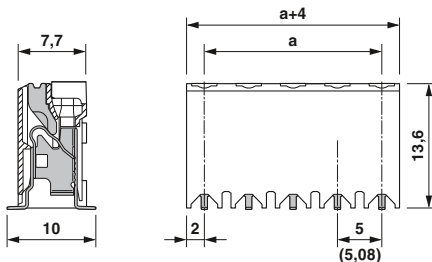

Drilling diagram



Drilling diagram

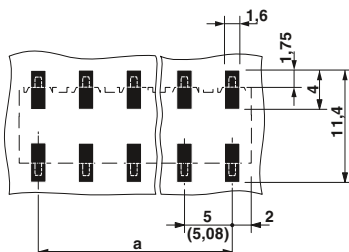

Ordering data

| Type | Order No. | Pcs. / Pkt. |
|--------------------------------------|-----------|-------------|
| Pitch 5.0 mm, color: black | | |
| SPT-SMD 1,5/ 2-H-5,0 R24 | 1824747 | 300 |
| SPT-SMD 1,5/ 3-H-5,0 R32 | 1824750 | 300 |
| SPT-SMD 1,5/ 4-H-5,0 R44 | 1824763 | 300 |
| SPT-SMD 1,5/ 5-H-5,0 R44 | 1824776 | 300 |
| SPT-SMD 1,5/ 6-H-5,0 R44 | 1824789 | 300 |
| SPT-SMD 1,5/ 7-H-5,0 R88 | 1824792 | 300 |
| SPT-SMD 1,5/ 8-H-5,0 R88 | 1824802 | 300 |
| SPT-SMD 1,5/ 9-H-5,0 R88 | 1824815 | 300 |
| SPT-SMD 1,5/10-H-5,0 R88 | 1824828 | 300 |
| SPT-SMD 1,5/11-H-5,0 R88 | 1824831 | 300 |
| SPT-SMD 1,5/12-H-5,0 R88 | 1824844 | 300 |
| Headers, 5.08 mm pitch, color: black | | |
| SPT-SMD 1,5/ 2-H-5,08 R24 | 1824857 | 300 |
| SPT-SMD 1,5/ 3-H-5,08 R32 | 1824860 | 300 |
| SPT-SMD 1,5/ 4-H-5,08 R44 | 1824873 | 300 |
| SPT-SMD 1,5/ 5-H-5,08 R44 | 1824885 | 300 |
| SPT-SMD 1,5/ 6-H-5,08 R44 | 1824899 | 300 |
| SPT-SMD 1,5/ 7-H-5,08 R88 | 1824909 | 300 |
| SPT-SMD 1,5/ 8-H-5,08 R88 | 1824912 | 300 |
| SPT-SMD 1,5/ 9-H-5,08 R88 | 1824925 | 300 |
| SPT-SMD 1,5/10-H-5,08 R88 | 1824938 | 300 |
| SPT-SMD 1,5/11-H-5,08 R88 | 1824941 | 300 |
| SPT-SMD 1,5/12-H-5,08 R88 | 1824954 | 300 |

Ordering data

| Type | Order No. | Pcs. / Pkt. |
|--------------------------------------|-----------|-------------|
| Pitch 5.0 mm, color: black | | |
| SPT-SMD 1,5/ 2-V-5,0 R24 | 1824307 | 200 |
| SPT-SMD 1,5/ 3-V-5,0 R32 | 1824310 | 200 |
| SPT-SMD 1,5/ 4-V-5,0 R44 | 1824323 | 200 |
| SPT-SMD 1,5/ 5-V-5,0 R44 | 1824336 | 200 |
| SPT-SMD 1,5/ 6-V-5,0 R44 | 1824349 | 200 |
| SPT-SMD 1,5/ 7-V-5,0 R88 | 1824352 | 200 |
| SPT-SMD 1,5/ 8-V-5,0 R88 | 1824365 | 200 |
| SPT-SMD 1,5/ 9-V-5,0 R88 | 1824378 | 200 |
| SPT-SMD 1,5/10-V-5,0 R88 | 1824381 | 200 |
| SPT-SMD 1,5/11-V-5,0 R88 | 1824394 | 200 |
| SPT-SMD 1,5/12-V-5,0 R88 | 1824404 | 200 |
| Headers, 5.08 mm pitch, color: black | | |
| SPT-SMD 1,5/ 2-V-5,08 R24 | 1824417 | 200 |
| SPT-SMD 1,5/ 3-V-5,08 R32 | 1824420 | 200 |
| SPT-SMD 1,5/ 4-V-5,08 R44 | 1824433 | 200 |
| SPT-SMD 1,5/ 5-V-5,08 R44 | 1824446 | 200 |
| SPT-SMD 1,5/ 6-V-5,08 R44 | 1824459 | 200 |
| SPT-SMD 1,5/ 7-V-5,08 R88 | 1824462 | 200 |
| SPT-SMD 1,5/ 8-V-5,08 R88 | 1824475 | 200 |
| SPT-SMD 1,5/ 9-V-5,08 R88 | 1824488 | 200 |
| SPT-SMD 1,5/10-V-5,08 R88 | 1824491 | 200 |
| SPT-SMD 1,5/11-V-5,08 R88 | 1824501 | 200 |
| SPT-SMD 1,5/12-V-5,08 R88 | 1824514 | 200 |

PCB terminal blocks with 2.54 to 7.62 mm pitch

THR PCB terminal blocks with push-in spring connection up to 1.5 mm²



- Push-in direct plug-in technology for solid or stranded conductors
- Suitable for use in SMT reflow processes
- Horizontal and vertical design with 3.5 mm and 3.81 mm pitch
- Two solder pins for a high level of stability on the PCB
- Standard pin length of 2.6 mm also suitable for wave soldering processes
- Supplied in tape-on-reel packing according to IEC 60286-3 for automated mounting in the reflow process with pin length of 2.0 mm
- Touch connection for voltage testing using a 1 mm Ø test pin

Notes:





Dimensional drawings of tape reels and place pads can be found online at phoenixcontact.net/products.

1) Current carrying capacity curve upon request.



Pin length of 2.6 mm, box-packaged PCB terminal blocks, connection direction horizontal to the PCB

For accessories, see Catalog 1

| For all types | Type | Page |
|--|---|------|
|  | Screwdriver SZS 0,4 x 2,5 Order No. 1205037 | |
|  | Ferrules with and without plastic sleeve | 834 |
|  | Crimping pliers for 0.25 to 6 mm ² CRIMPFOX 6 Order No. 1212034 | |
|  | Test plug MPS-MT 1-S Order No. 1944372 | 831 |

Dimensional drawing

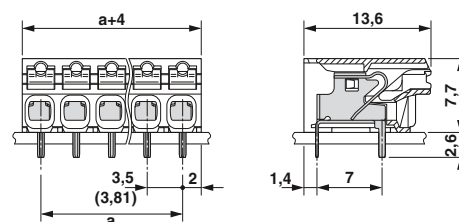

Drilling diagram

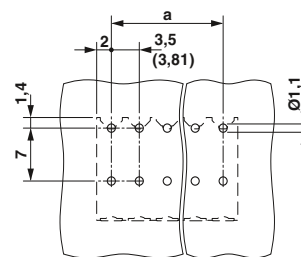

Technical data

| Technical data in accordance to IEC / DIN VDE | |
|--|---|
| Rated current / conductor cross section | [A] / [mm ²] |
| Rated insulation voltage for pollution degree 2 | [V] |
| Pitch | [mm] |
| Connection capacity | |
| Solid / stranded | [mm ²] / [mm ²] / AWG |
| Stranded with ferrules without plastic sleeve | [mm ²] |
| Stranded with ferrules with plastic sleeve | [mm ²] |
| Multi-conductor connection capacity (two conductors with the same cross section) | |
| Solid / stranded | [mm ²] |
| Stranded with ferrules without plastic sleeve | [mm ²] |
| Stranded with TWIN ferrule with plastic sleeve | [mm ²] |
| Insulation coordination | |
| Surge voltage category / pollution degree | III / 3 III / 2 II / 2 |
| Rated insulation voltage | [V] |
| Rated surge voltage | [kV] |
| Approval data (UL/CUL) | Use Group |
| Nominal voltage | [V] |
| Nominal current | [A] |
| Connection capacity AWG | AWG |
| Approval data (CSA) | Use Group |
| Nominal voltage | [V] |
| Nominal current | [A] |
| Connection capacity AWG | AWG |
| General data | |
| Stripping length | [mm] |
| Type of insulation material / insulation material group | |
| Inflammability class according to UL 94 | |
| Drill hole diameter / pin dimensions | [mm] |

| | | |
|---------------------------------|---------|--------|
| 13.5 ¹⁾ / 1.5 | | |
| 160 | | |
| 3.5 / 3.81 | | |
| 0.2 - 1.5 / 0.2 - 1.5 / 24 - 16 | | |
| 0.2 - 1.5 | | |
| 0.2 - 0.75 | | |
| - / - | | |
| - | | |
| - | | |
| III / 3 | III / 2 | II / 2 |
| 160 | 160 | 320 |
| 2.5 | 2.5 | 2.5 |
| B | C | D |
| - | - | - |
| - | - | - |
| - | - | - |
| B | C | D |
| - | - | - |
| - | - | - |
| - | - | - |
| - | - | - |
| 8 | | |
| LCP / IIIa | | |
| V0 | | |
| 1.1 / 0.7 x 0.3 | | |

| No. of pos. | Dim. a [mm] |
|-------------|-------------|
| 2 | 3.50 |
| 3 | 7.00 |
| 4 | 10.50 |
| 5 | 14.00 |
| 6 | 17.50 |
| 7 | 21.00 |
| 8 | 24.50 |
| 9 | 28.00 |
| 10 | 31.50 |
| 11 | 35.00 |
| 12 | 38.50 |

Ordering data

| Type | Order No. | Pcs. / Pkt. |
|------------------------------------|-----------|-------------|
| Pitch 3.5 mm, color: black | | |
| SPT-THR 1,5/ 2-H-3,5 P26 | 1822752 | 370 |
| SPT-THR 1,5/ 3-H-3,5 P26 | 1822765 | 240 |
| SPT-THR 1,5/ 4-H-3,5 P26 | 1822778 | 170 |
| SPT-THR 1,5/ 5-H-3,5 P26 | 1822781 | 150 |
| SPT-THR 1,5/ 6-H-3,5 P26 | 1822794 | 130 |
| SPT-THR 1,5/ 7-H-3,5 P26 | 1822804 | 110 |
| SPT-THR 1,5/ 8-H-3,5 P26 | 1822817 | 80 |
| SPT-THR 1,5/ 9-H-3,5 P26 | 1822820 | 80 |
| SPT-THR 1,5/10-H-3,5 P26 | 1822833 | 60 |
| SPT-THR 1,5/11-H-3,5 P26 | 1822846 | 60 |
| SPT-THR 1,5/12-H-3,5 P26 | 1822859 | 60 |
| 3.81 mm pitch, color: black | | |
| SPT-THR 1,5/ 2-H-3,81 P26 | 1822862 | 350 |
| SPT-THR 1,5/ 3-H-3,81 P26 | 1822875 | 240 |
| SPT-THR 1,5/ 4-H-3,81 P26 | 1822888 | 170 |
| SPT-THR 1,5/ 5-H-3,81 P26 | 1822891 | 130 |
| SPT-THR 1,5/ 6-H-3,81 P26 | 1822901 | 110 |
| SPT-THR 1,5/ 7-H-3,81 P26 | 1822914 | 80 |
| SPT-THR 1,5/ 8-H-3,81 P26 | 1822927 | 80 |
| SPT-THR 1,5/ 9-H-3,81 P26 | 1822930 | 60 |
| SPT-THR 1,5/10-H-3,81 P26 | 1822943 | 60 |
| SPT-THR 1,5/11-H-3,81 P26 | 1822956 | 60 |
| SPT-THR 1,5/12-H-3,81 P26 | 1822969 | 60 |



Pin length of 2.6 mm, box-packaged PCB terminal blocks, connection direction vertical to the PCB



Pin length of 2.0 mm, taped PCB terminal blocks, connection direction horizontal to the PCB



Pin length of 2.0 mm, taped PCB terminal blocks, connection direction vertical to the PCB



Dimensional drawing

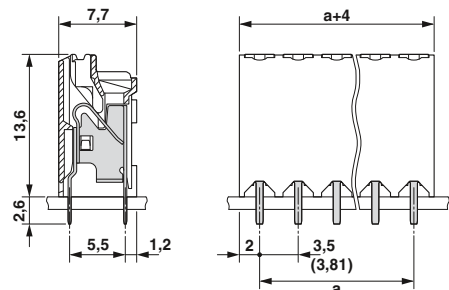

Drilling diagram

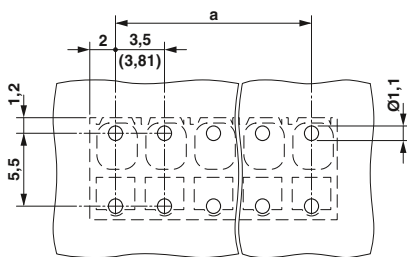

Ordering data

| Type | Order No. | Pcs. / Pkt. |
|------------------------------------|-----------|-------------|
| Pitch 3.5 mm, color: black | | |
| SPT-THR 1,5/ 2-V-3,5 P26 | 1822312 | 540 |
| SPT-THR 1,5/ 3-V-3,5 P26 | 1822325 | 350 |
| SPT-THR 1,5/ 4-V-3,5 P26 | 1822338 | 250 |
| SPT-THR 1,5/ 5-V-3,5 P26 | 1822341 | 220 |
| SPT-THR 1,5/ 6-V-3,5 P26 | 1822354 | 190 |
| SPT-THR 1,5/ 7-V-3,5 P26 | 1822367 | 160 |
| SPT-THR 1,5/ 8-V-3,5 P26 | 1822370 | 120 |
| SPT-THR 1,5/ 9-V-3,5 P26 | 1822383 | 120 |
| SPT-THR 1,5/10-V-3,5 P26 | 1822396 | 90 |
| SPT-THR 1,5/11-V-3,5 P26 | 1822406 | 90 |
| SPT-THR 1,5/12-V-3,5 P26 | 1822419 | 90 |
| 3.81 mm pitch, color: black | | |
| SPT-THR 1,5/ 2-V-3,81 P26 | 1822422 | 510 |
| SPT-THR 1,5/ 3-V-3,81 P26 | 1822435 | 350 |
| SPT-THR 1,5/ 4-V-3,81 P26 | 1822448 | 250 |
| SPT-THR 1,5/ 5-V-3,81 P26 | 1822451 | 190 |
| SPT-THR 1,5/ 6-V-3,81 P26 | 1822464 | 160 |
| SPT-THR 1,5/ 7-V-3,81 P26 | 1822477 | 120 |
| SPT-THR 1,5/ 8-V-3,81 P26 | 1822480 | 120 |
| SPT-THR 1,5/ 9-V-3,81 P26 | 1822493 | 90 |
| SPT-THR 1,5/10-V-3,81 P26 | 1822503 | 90 |
| SPT-THR 1,5/11-V-3,81 P26 | 1822516 | 90 |
| SPT-THR 1,5/12-V-3,81 P26 | 1822529 | 60 |



Dimensional drawing

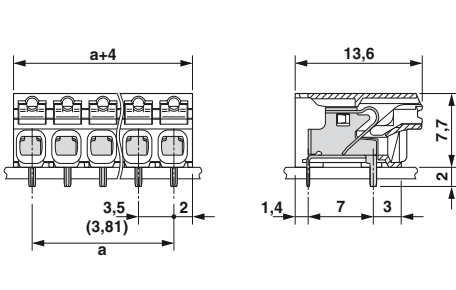

Drilling diagram

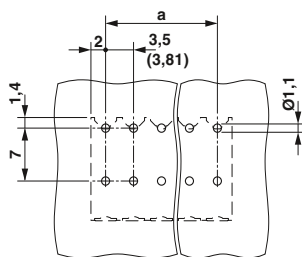

Ordering data

| Type | Order No. | Pcs. / Pkt. |
|------------------------------------|-----------|-------------|
| Pitch 3.5 mm, color: black | | |
| SPT-THR 1,5/ 2-H-3,5 P20 R24 | 1823638 | 250 |
| SPT-THR 1,5/ 3-H-3,5 P20 R32 | 1823641 | 250 |
| SPT-THR 1,5/ 4-H-3,5 P20 R32 | 1823654 | 250 |
| SPT-THR 1,5/ 5-H-3,5 P20 R32 | 1823667 | 250 |
| SPT-THR 1,5/ 6-H-3,5 P20 R44 | 1823670 | 250 |
| SPT-THR 1,5/ 7-H-3,5 P20 R44 | 1823683 | 250 |
| SPT-THR 1,5/ 8-H-3,5 P20 R44 | 1823696 | 250 |
| SPT-THR 1,5/ 9-H-3,5 P20 R72 | 1823706 | 250 |
| SPT-THR 1,5/10-H-3,5 P20 R72 | 1823719 | 250 |
| SPT-THR 1,5/11-H-3,5 P20 R72 | 1823722 | 250 |
| SPT-THR 1,5/12-H-3,5 P20 R72 | 1823735 | 250 |
| 3.81 mm pitch, color: black | | |
| SPT-THR 1,5/ 2-H-3,81 P20 R24 | 1823748 | 250 |
| SPT-THR 1,5/ 3-H-3,81 P20 R32 | 1823751 | 250 |
| SPT-THR 1,5/ 4-H-3,81 P20 R32 | 1823764 | 250 |
| SPT-THR 1,5/ 5-H-3,81 P20 R32 | 1823777 | 250 |
| SPT-THR 1,5/ 6-H-3,81 P20 R44 | 1823780 | 250 |
| SPT-THR 1,5/ 7-H-3,81 P20 R44 | 1823793 | 250 |
| SPT-THR 1,5/ 8-H-3,81 P20 R44 | 1823803 | 250 |
| SPT-THR 1,5/ 9-H-3,81 P20 R72 | 1823816 | 250 |
| SPT-THR 1,5/10-H-3,81 P20 R72 | 1823829 | 250 |
| SPT-THR 1,5/11-H-3,81 P20 R72 | 1823832 | 250 |
| SPT-THR 1,5/12-H-3,81 P20 R72 | 1823845 | 250 |



Dimensional drawing

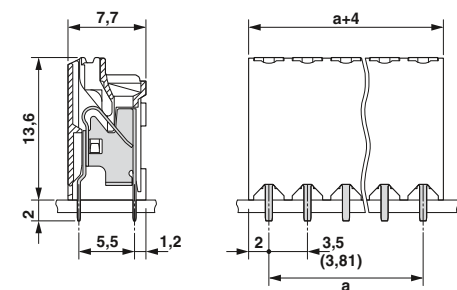

Drilling diagram

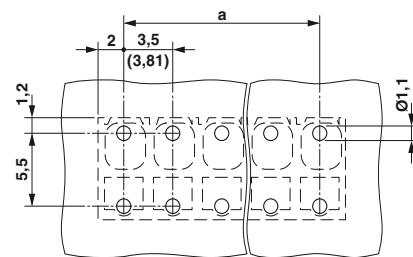

Ordering data

| Type | Order No. | Pcs. / Pkt. |
|------------------------------------|-----------|-------------|
| Pitch 3.5 mm, color: black | | |
| SPT-THR 1,5/ 2-V-3,5 P20 R24 | 1823191 | 180 |
| SPT-THR 1,5/ 3-V-3,5 P20 R24 | 1823201 | 180 |
| SPT-THR 1,5/ 4-V-3,5 P20 R44 | 1823214 | 180 |
| SPT-THR 1,5/ 5-V-3,5 P20 R44 | 1823227 | 180 |
| SPT-THR 1,5/ 6-V-3,5 P20 R44 | 1823230 | 180 |
| SPT-THR 1,5/ 7-V-3,5 P20 R44 | 1823243 | 180 |
| SPT-THR 1,5/ 8-V-3,5 P20 R72 | 1823256 | 180 |
| SPT-THR 1,5/ 9-V-3,5 P20 R72 | 1823269 | 180 |
| SPT-THR 1,5/10-V-3,5 P20 R72 | 1823272 | 180 |
| SPT-THR 1,5/11-V-3,5 P20 R72 | 1823285 | 180 |
| SPT-THR 1,5/12-V-3,5 P20 R72 | 1823298 | 180 |
| 3.81 mm pitch, color: black | | |
| SPT-THR 1,5/ 2-V-3,81 P20 R24 | 1823308 | 180 |
| SPT-THR 1,5/ 3-V-3,81 P20 R24 | 1823311 | 180 |
| SPT-THR 1,5/ 4-V-3,81 P20 R44 | 1823324 | 180 |
| SPT-THR 1,5/ 5-V-3,81 P20 R44 | 1823337 | 180 |
| SPT-THR 1,5/ 6-V-3,81 P20 R44 | 1823340 | 180 |
| SPT-THR 1,5/ 7-V-3,81 P20 R44 | 1823353 | 180 |
| SPT-THR 1,5/ 8-V-3,81 P20 R72 | 1823366 | 180 |
| SPT-THR 1,5/ 9-V-3,81 P20 R72 | 1823379 | 180 |
| SPT-THR 1,5/10-V-3,81 P20 R72 | 1823382 | 180 |
| SPT-THR 1,5/11-V-3,81 P20 R72 | 1823395 | 180 |
| SPT-THR 1,5/12-V-3,81 P20 R72 | 1823405 | 180 |

PCB terminal blocks with 2.54 to 7.62 mm pitch

THR PCB terminal blocks with push-in spring connection up to 1.5 mm²



- Push-in direct plug-in technology for solid or stranded conductors
- Suitable for use in SMT reflow processes
- Horizontal and vertical design with 5.0 mm and 5.08 mm pitch
- Two solder pins for a high level of stability on the PCB
- Standard pin length of 2.6 mm also suitable for wave soldering processes
- Supplied in tape-on-reel packing according to IEC 60286-3 for automated mounting in the reflow process with pin length of 2.0 mm
- Touch connection for voltage testing using a 1 mm Ø test pin

Notes:





Dimensional drawings of tape reels and place pads can be found online at phoenixcontact.net/products.

1) Current carrying capacity curve upon request.



Pin length of 2.6 mm, box-packaged PCB terminal blocks, connection direction horizontal to the PCB

For accessories, see Catalog 1

| For all types | Type | Page |
|--|---|------|
|  | Screwdriver SZS 0,4 x 2,5 Order No. 1205037 | |
|  | Ferrules with and without plastic sleeve | 834 |
|  | Crimping pliers for 0.25 to 6 mm ² CRIMPFOX 6 Order No. 1212034 | |
|  | Test plug MPS-MT 1-S Order No. 1944372 | 831 |

Dimensional drawing

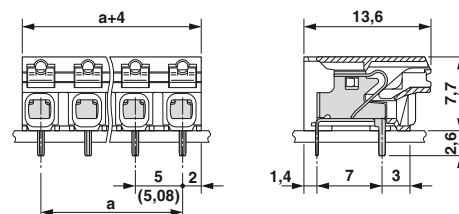

Drilling diagram

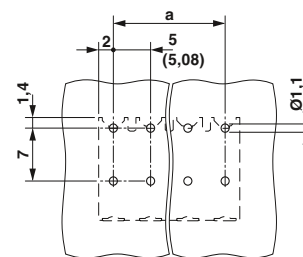

Technical data

| | |
|--|---|
| Technical data in accordance to IEC / DIN VDE | |
| Rated current / conductor cross section | [A] / [mm ²] |
| Rated insulation voltage for pollution degree 2 | [V] |
| Pitch | [mm] |
| Connection capacity | |
| Solid / stranded | [mm ²] / [mm ²] / AWG |
| Stranded with ferrules without plastic sleeve | [mm ²] |
| Stranded with ferrules with plastic sleeve | [mm ²] |
| Multi-conductor connection capacity (two conductors with the same cross section) | |
| Solid / stranded | [mm ²] |
| Stranded with ferrules without plastic sleeve | [mm ²] |
| Stranded with TWIN ferrule with plastic sleeve | [mm ²] |
| Insulation coordination | |
| Surge voltage category / pollution degree | III / 3 III / 2 II / 2 |
| Rated insulation voltage | [V] |
| Rated surge voltage | [kV] |
| Approval data (UL/CUL) | Use Group |
| Nominal voltage | [V] |
| Nominal current | [A] |
| Connection capacity AWG | AWG |
| Approval data (CSA) | Use Group |
| Nominal voltage | [V] |
| Nominal current | [A] |
| Connection capacity AWG | AWG |
| General data | |
| Stripping length | [mm] |
| Type of insulation material / insulation material group | |
| Inflammability class according to UL 94 | |
| Drill hole diameter / pin dimensions | [mm] |

| | | |
|---------------------------------|---------|--------|
| 13.5 ¹⁾ / 1.5 | | |
| 320 | | |
| 5 / 5.08 | | |
| 0.2 - 1.5 / 0.2 - 1.5 / 24 - 16 | | |
| 0.2 - 1.5 | | |
| 0.2 - 0.75 | | |
| - / - | | |
| - | | |
| - | | |
| III / 3 | III / 2 | II / 2 |
| 250 | 320 | 500 |
| 4 | 4 | 4 |
| B | C | D |
| - | - | - |
| - | - | - |
| - | - | - |
| B | C | D |
| - | - | - |
| - | - | - |
| - | - | - |
| - | - | - |
| 8 | | |
| LCP / IIIa | | |
| V0 | | |
| 1.1 / 0.7 x 0.3 mm | | |

| No. of pos. | Dim. a [mm] |
|-------------|-------------|
| 2 | 5.00 |
| 3 | 10.00 |
| 4 | 15.00 |
| 5 | 20.00 |
| 6 | 25.00 |
| 7 | 30.00 |
| 8 | 35.00 |
| 9 | 40.00 |
| 10 | 45.00 |
| 11 | 50.00 |
| 12 | 55.00 |

Ordering data

| Type | Order No. | Pcs. / Pkt. |
|--------------------------------------|-----------|-------------|
| Pitch 5.0 mm, color: black | | |
| SPT-THR 1,5/ 2-H-5,0 P26 | 1822972 | 300 |
| SPT-THR 1,5/ 3-H-5,0 P26 | 1822985 | 190 |
| SPT-THR 1,5/ 4-H-5,0 P26 | 1822998 | 130 |
| SPT-THR 1,5/ 5-H-5,0 P26 | 1823007 | 110 |
| SPT-THR 1,5/ 6-H-5,0 P26 | 1823010 | 80 |
| SPT-THR 1,5/ 7-H-5,0 P26 | 1823023 | 60 |
| SPT-THR 1,5/ 8-H-5,0 P26 | 1823036 | 60 |
| SPT-THR 1,5/ 9-H-5,0 P26 | 1823049 | 40 |
| SPT-THR 1,5/10-H-5,0 P26 | 1823052 | 40 |
| SPT-THR 1,5/11-H-5,0 P26 | 1823065 | 40 |
| SPT-THR 1,5/12-H-5,0 P26 | 1823078 | 40 |
| Headers, 5.08 mm pitch, color: black | | |
| SPT-THR 1,5/ 2-H-5,08 P26 | 1823081 | 300 |
| SPT-THR 1,5/ 3-H-5,08 P26 | 1823094 | 190 |
| SPT-THR 1,5/ 4-H-5,08 P26 | 1823104 | 130 |
| SPT-THR 1,5/ 5-H-5,08 P26 | 1823117 | 110 |
| SPT-THR 1,5/ 6-H-5,08 P26 | 1823120 | 80 |
| SPT-THR 1,5/ 7-H-5,08 P26 | 1823133 | 60 |
| SPT-THR 1,5/ 8-H-5,08 P26 | 1823146 | 60 |
| SPT-THR 1,5/ 9-H-5,08 P26 | 1823159 | 40 |
| SPT-THR 1,5/10-H-5,08 P26 | 1823162 | 40 |
| SPT-THR 1,5/11-H-5,08 P26 | 1823175 | 40 |
| SPT-THR 1,5/12-H-5,08 P26 | 1823188 | 40 |



Pin length of 2.6 mm, box-packaged PCB terminal blocks, connection direction vertical to the PCB



Pin length of 2.0 mm, taped PCB terminal blocks, connection direction horizontal to the PCB



Pin length of 2.0 mm, taped PCB terminal blocks, connection direction vertical to the PCB



Dimensional drawing

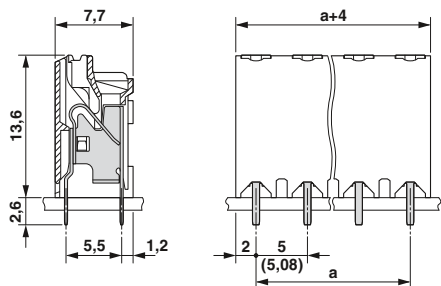

Drilling diagram

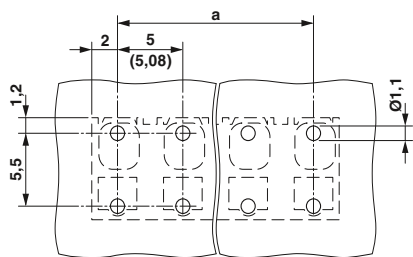

Dimensional drawing

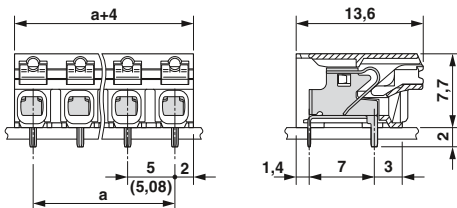

Drilling diagram

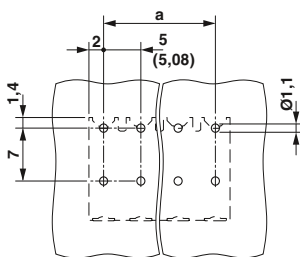

Dimensional drawing

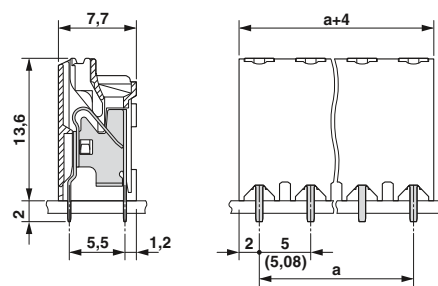

Drilling diagram

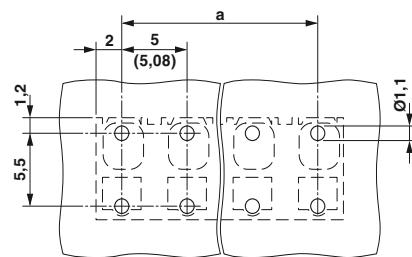

Ordering data

| Type | Order No. | Pcs. / Pkt. |
|---|-----------|-------------|
| Pitch 5.0 mm, color: black | | |
| SPT-THR 1,5/ 2-V-5,0 P26 | 1822532 | 440 |
| SPT-THR 1,5/ 3-V-5,0 P26 | 1822545 | 280 |
| SPT-THR 1,5/ 4-V-5,0 P26 | 1822558 | 190 |
| SPT-THR 1,5/ 5-V-5,0 P26 | 1822561 | 160 |
| SPT-THR 1,5/ 6-V-5,0 P26 | 1822574 | 120 |
| SPT-THR 1,5/ 7-V-5,0 P26 | 1822587 | 90 |
| SPT-THR 1,5/ 8-V-5,0 P26 | 1822590 | 90 |
| SPT-THR 1,5/ 9-V-5,0 P26 | 1822600 | 60 |
| SPT-THR 1,5/10-V-5,0 P26 | 1822613 | 60 |
| SPT-THR 1,5/11-V-5,0 P26 | 1822626 | 60 |
| SPT-THR 1,5/12-V-5,0 P26 | 1822639 | 60 |
| Headers, 5.08 mm pitch, color: black | | |
| SPT-THR 1,5/ 2-V-5,08 P26 | 1822642 | 440 |
| SPT-THR 1,5/ 3-V-5,08 P26 | 1822655 | 280 |
| SPT-THR 1,5/ 4-V-5,08 P26 | 1822668 | 190 |
| SPT-THR 1,5/ 5-V-5,08 P26 | 1822671 | 160 |
| SPT-THR 1,5/ 6-V-5,08 P26 | 1822684 | 120 |
| SPT-THR 1,5/ 7-V-5,08 P26 | 1822697 | 90 |
| SPT-THR 1,5/ 8-V-5,08 P26 | 1822707 | 90 |
| SPT-THR 1,5/ 9-V-5,08 P26 | 1822710 | 60 |
| SPT-THR 1,5/10-V-5,08 P26 | 1822723 | 60 |
| SPT-THR 1,5/11-V-5,08 P26 | 1822736 | 60 |
| SPT-THR 1,5/12-V-5,08 P26 | 1822749 | 60 |

Ordering data

| Type | Order No. | Pcs. / Pkt. |
|---|-----------|-------------|
| Pitch 5.0 mm, color: black | | |
| SPT-THR 1,5/ 2-H-5,0 P20 R24 | 1823858 | 250 |
| SPT-THR 1,5/ 3-H-5,0 P20 R32 | 1823861 | 250 |
| SPT-THR 1,5/ 4-H-5,0 P20 R32 | 1823874 | 250 |
| SPT-THR 1,5/ 5-H-5,0 P20 R56 | 1823887 | 250 |
| SPT-THR 1,5/ 6-H-5,0 P20 R56 | 1823890 | 250 |
| SPT-THR 1,5/ 7-H-5,0 P20 R56 | 1823900 | 250 |
| SPT-THR 1,5/ 8-H-5,0 P20 R56 | 1823913 | 250 |
| SPT-THR 1,5/ 9-H-5,0 P20 R88 | 1823926 | 250 |
| SPT-THR 1,5/10-H-5,0 P20 R88 | 1823939 | 250 |
| SPT-THR 1,5/11-H-5,0 P20 R88 | 1823942 | 250 |
| SPT-THR 1,5/12-H-5,0 P20 R88 | 1823955 | 250 |
| Headers, 5.08 mm pitch, color: black | | |
| SPT-THR 1,5/ 2-H-5,08 P20 R24 | 1823968 | 250 |
| SPT-THR 1,5/ 3-H-5,08 P20 R32 | 1823971 | 250 |
| SPT-THR 1,5/ 4-H-5,08 P20 R32 | 1823984 | 250 |
| SPT-THR 1,5/ 5-H-5,08 P20 R56 | 1823997 | 250 |
| SPT-THR 1,5/ 6-H-5,08 P20 R56 | 1824006 | 250 |
| SPT-THR 1,5/ 7-H-5,08 P20 R56 | 1824019 | 250 |
| SPT-THR 1,5/ 8-H-5,08 P20 R56 | 1824022 | 250 |
| SPT-THR 1,5/ 9-H-5,08 P20 R88 | 1824035 | 250 |
| SPT-THR 1,5/10-H-5,08 P20 R88 | 1824048 | 250 |
| SPT-THR 1,5/11-H-5,08 P20 R88 | 1824051 | 250 |
| SPT-THR 1,5/12-H-5,08 P20 R88 | 1824064 | 250 |

Ordering data

| Type | Order No. | Pcs. / Pkt. |
|---|-----------|-------------|
| Pitch 5.0 mm, color: black | | |
| SPT-THR 1,5/ 2-V-5,0 P20 R24 | 1823418 | 180 |
| SPT-THR 1,5/ 3-V-5,0 P20 R32 | 1823421 | 180 |
| SPT-THR 1,5/ 4-V-5,0 P20 R56 | 1823434 | 180 |
| SPT-THR 1,5/ 5-V-5,0 P20 R56 | 1823447 | 180 |
| SPT-THR 1,5/ 6-V-5,0 P20 R56 | 1823450 | 180 |
| SPT-THR 1,5/ 7-V-5,0 P20 R56 | 1823463 | 180 |
| SPT-THR 1,5/ 8-V-5,0 P20 R88 | 1823476 | 180 |
| SPT-THR 1,5/ 9-V-5,0 P20 R88 | 1823489 | 180 |
| SPT-THR 1,5/10-V-5,0 P20 R88 | 1823492 | 180 |
| SPT-THR 1,5/11-V-5,0 P20 R88 | 1823502 | 180 |
| SPT-THR 1,5/12-V-5,0 P20 R88 | 1823515 | 180 |
| Headers, 5.08 mm pitch, color: black | | |
| SPT-THR 1,5/ 2-V-5,08 P20 R24 | 1823528 | 180 |
| SPT-THR 1,5/ 3-V-5,08 P20 R32 | 1823531 | 180 |
| SPT-THR 1,5/ 4-V-5,08 P20 R56 | 1823544 | 180 |
| SPT-THR 1,5/ 5-V-5,08 P20 R56 | 1823557 | 180 |
| SPT-THR 1,5/ 6-V-5,08 P20 R56 | 1823560 | 180 |
| SPT-THR 1,5/ 7-V-5,08 P20 R56 | 1823573 | 180 |
| SPT-THR 1,5/ 8-V-5,08 P20 R88 | 1823586 | 180 |
| SPT-THR 1,5/ 9-V-5,08 P20 R88 | 1823599 | 180 |
| SPT-THR 1,5/10-V-5,08 P20 R88 | 1823609 | 180 |
| SPT-THR 1,5/11-V-5,08 P20 R88 | 1823612 | 180 |
| SPT-THR 1,5/12-V-5,08 P20 R88 | 1823625 | 180 |

PCB terminal blocks with 2.54 to 7.62 mm pitch

Double-level PCB terminal blocks with push-in spring connection up to 1.5 mm²

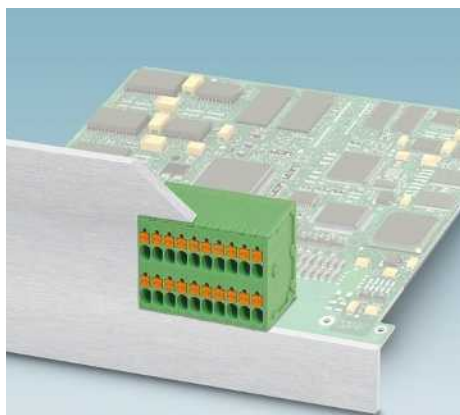





- Push-in connection with spring lever for tool-free conductor connection
- Unique integration into front panels in two rows
- Conductor cross sections up to 1.5 mm² with ferrule
- Printing area at the front
- Touch connection for voltage testing using a 1 mm test pin

Notes:

1) Current carrying capacity curve upon request.

For accessories, see Catalog 1

| For all types | Type | Page |
|---|---|------|
|  | Marker cards SK 3,5/2,8 | 796 |
|  | Screwdriver SZS 0,4 x 2,5 Order No. 1205037 | |
|  | Ferrules with and without plastic sleeve | 834 |
|  | Crimping pliers for 0.25 to 6 mm ² CRIMPFOX 6 Order No. 1212034 | |
|  | Test plug MPS-MT 1-S Order No. 1944372 | 831 |

Technical data

Technical data in accordance to IEC / DIN VDE

Rated current / conductor cross section [A] / [mm²]

Rated insulation voltage for pollution degree 2 [V]

Pitch [mm]

Connection capacity

Solid / stranded [mm²] / [mm²] / AWG

Stranded with ferrules without plastic sleeve [mm²]

Stranded with ferrules with plastic sleeve [mm²]

Insulation coordination

Surge voltage category / pollution degree

Rated insulation voltage [V]

Rated surge voltage [kV]

Approval data (UL/CUL) Use Group

Nominal voltage [V]

Nominal current [A]

Connection capacity AWG

Approval data (CSA) Use Group

Nominal voltage [V]

Nominal current [A]

Connection capacity AWG

General data

Stripping length [mm]

Type of insulation material / insulation material group

Inflammability class according to UL 94

Drill hole diameter / pin dimensions [mm]

10¹⁾ / 1.5

200

3.5

0.14 - 1.5 / 0.14 - 1.5 / 24 - 14

0.2 - 1.5

0.2 - 1.5

III / 3 III / 2 II / 2

160 200 400

2.5 2.5 2.5

B C D

- - -

- - -

- - -

B C D

- - -

- - -

- - -

8

PA / I

V0

1.3 / 0.6 x 1.0 mm

No. of pos. Dim. a [mm]

2 3.50

3 7.00

4 10.50

5 14.00

6 17.50

7 21.00

8 24.50

9 28.00

10 31.50

11 35.00

12 38.50



Horizontal connection direction

Dimensional drawing

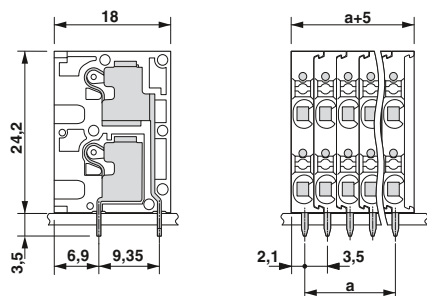

Drilling diagram

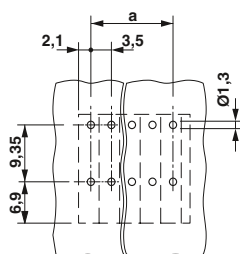

Ordering data

| Type | Order No. | Pcs. / Pkt. |
|----------------------------|-----------|-------------|
| 3.5 mm pitch, color: green | | |
| SPTD 1,5/ 2-H-3,5 | 1841490 | 100 |
| SPTD 1,5/ 3-H-3,5 | 1841500 | 100 |
| SPTD 1,5/ 4-H-3,5 | 1841513 | 100 |
| SPTD 1,5/ 5-H-3,5 | 1841526 | 100 |
| SPTD 1,5/ 6-H-3,5 | 1841539 | 100 |
| SPTD 1,5/ 7-H-3,5 | 1841542 | 100 |
| SPTD 1,5/ 8-H-3,5 | 1841555 | 100 |
| SPTD 1,5/ 9-H-3,5 | 1841568 | 100 |
| SPTD 1,5/10-H-3,5 | 1841571 | 100 |
| SPTD 1,5/11-H-3,5 | 1841584 | 100 |
| SPTD 1,5/12-H-3,5 | 1841597 | 100 |

Inverted headers for reflow processes



- Inverted headers with a 3.5 mm pitch
- Plug-in direction parallel or vertical to the PCB
- Versions with snap-in lug for locking inverted plugs with self-locking flanges
- You can find user notes and recommendations for the THR procedure in Catalog 1
- Combination with MC 1,5 pin strips for the PCB/PCB connection

Notes:

In accordance with DIN EN 61984, COMBICON connectors have no switching power. During designated use, they must not be plugged in or disconnected when carrying voltage or under load.

COMBICON select

Possible combinations for connectors can be found in COMBICON select at phoenixcontact.net/products.

¹⁾ Current carrying capacity curve upon request.



2.0 mm pin length
Box-packaged headers,
Plug-in direction parallel to the PCB

For accessories, see Catalog 1

| For all types | Type | Page |
|---|----------------------------|------|
|  | Marker cards SK 3,5/2,8 | 796 |

Dimensional drawing

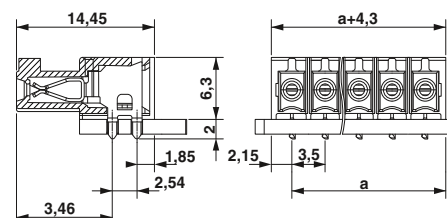

Drilling diagram

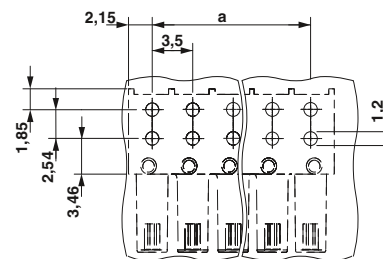

Technical data

Technical data in accordance to IEC / DIN VDE

| | | |
|---|-----------|------------------------|
| Rated current | [A] | 8 ¹⁾ |
| Rated insulation voltage for pollution degree 2 | [V] | 160 |
| Pitch | [mm] | 3.5 |
| Insulation coordination | | |
| Surge voltage category / pollution degree | | III / 3 III / 2 II / 2 |
| Rated insulation voltage | [V] | 160 160 320 |
| Rated surge voltage | [kV] | 2.5 2.5 2.5 |
| Approval data (UL/CUL) | Use Group | B C D |
| Nominal voltage | [V] | - - - |
| Nominal current | [A] | - - - |
| Connection capacity AWG | AWG | - - - |
| Approval data (CSA) | Use Group | B C D |
| Nominal voltage | [V] | - - - |
| Nominal current | [A] | - - - |
| Connection capacity AWG | AWG | - - - |
| General data | | |
| Type of insulation material / insulation material group | | LCP / IIIa |
| Inflammability class according to UL 94 | | V0 |
| Drill hole diameter / pin dimensions | [mm] | 1.2 / 0.8 x 0.8 mm |

Ordering data

| Type | Order No. | Pcs. / Pkt. |
|----------------------------|-----------|-------------|
| Pitch 3.5 mm, color: black | | |
| IMC 1,5/ 2-G-3,5 P20 THR | 1830414 | 50 |
| IMC 1,5/ 3-G-3,5 P20 THR | 1830427 | 50 |
| IMC 1,5/ 4-G-3,5 P20 THR | 1830430 | 50 |
| IMC 1,5/ 5-G-3,5 P20 THR | 1830443 | 50 |
| IMC 1,5/ 6-G-3,5 P20 THR | 1830456 | 50 |
| IMC 1,5/ 7-G-3,5 P20 THR | 1830469 | 50 |
| IMC 1,5/ 8-G-3,5 P20 THR | 1830472 | 50 |
| IMC 1,5/ 9-G-3,5 P20 THR | 1830485 | 50 |
| IMC 1,5/10-G-3,5 P20 THR | 1830498 | 50 |
| IMC 1,5/11-G-3,5 P20 THR | 1830508 | 50 |
| IMC 1,5/12-G-3,5 P20 THR | 1830511 | 50 |



Pin length of 2.0 mm, with snap-in lug,
box-packaged headers,
plug-in direction parallel to the PCB



2.0 mm pin length
Box-packaged headers,
Plug-in direction vertical to the PCB



Pin length of 2.0 mm, with snap-in lug,
box-packaged headers,
plug-in direction vertical to the PCB

Dimensional drawing

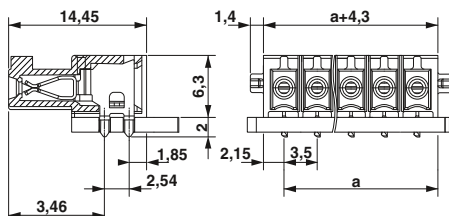

Dimensional drawing

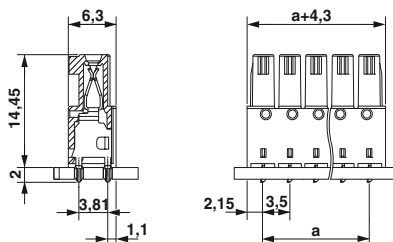

Dimensional drawing

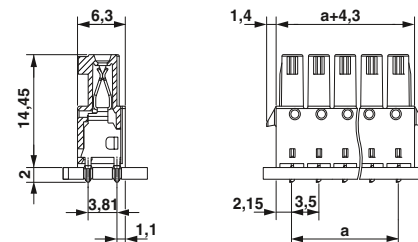

Drilling diagram

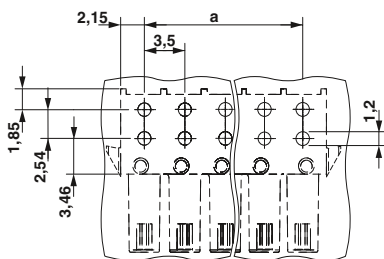

Drilling diagram

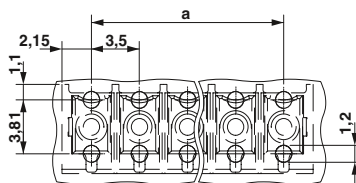

Drilling diagram

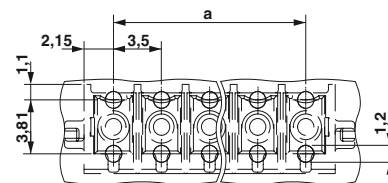

Ordering data

| Type | Order No. | Pcs. / Pkt. |
|-----------------------------|-----------|-------------|
| Pitch 3.5 mm, color: black | | |
| IMC 1,5/ 2-G-3,5 RN P20 THR | 1830566 | 50 |
| IMC 1,5/ 3-G-3,5 RN P20 THR | 1830579 | 50 |
| IMC 1,5/ 4-G-3,5 RN P20 THR | 1830582 | 50 |
| IMC 1,5/ 5-G-3,5 RN P20 THR | 1830595 | 50 |
| IMC 1,5/ 6-G-3,5 RN P20 THR | 1830605 | 50 |
| IMC 1,5/ 7-G-3,5 RN P20 THR | 1830618 | 50 |
| IMC 1,5/ 8-G-3,5 RN P20 THR | 1830621 | 50 |
| IMC 1,5/ 9-G-3,5 RN P20 THR | 1830634 | 50 |
| IMC 1,5/10-G-3,5 RN P20 THR | 1830647 | 50 |
| IMC 1,5/11-G-3,5 RN P20 THR | 1830650 | 50 |
| IMC 1,5/12-G-3,5 RN P20 THR | 1830663 | 50 |

Ordering data

| Type | Order No. | Pcs. / Pkt. |
|----------------------------|-----------|-------------|
| Pitch 3.5 mm, color: black | | |
| IMCV 1,5/ 2-G-3,5 P20 THR | 1830715 | 50 |
| IMCV 1,5/ 3-G-3,5 P20 THR | 1830728 | 50 |
| IMCV 1,5/ 4-G-3,5 P20 THR | 1830731 | 50 |
| IMCV 1,5/ 5-G-3,5 P20 THR | 1830744 | 50 |
| IMCV 1,5/ 6-G-3,5 P20 THR | 1830757 | 50 |
| IMCV 1,5/ 7-G-3,5 P20 THR | 1830760 | 50 |
| IMCV 1,5/ 8-G-3,5 P20 THR | 1830773 | 50 |
| IMCV 1,5/ 9-G-3,5 P20 THR | 1830786 | 50 |
| IMCV 1,5/10-G-3,5 P20 THR | 1830799 | 50 |
| IMCV 1,5/11-G-3,5 P20 THR | 1830809 | 50 |
| IMCV 1,5/12-G-3,5 P20 THR | 1830812 | 50 |

Ordering data

| Type | Order No. | Pcs. / Pkt. |
|------------------------------|-----------|-------------|
| Pitch 3.5 mm, color: black | | |
| IMCV 1,5/ 2-G-3,5 RN P20 THR | 1830867 | 50 |
| IMCV 1,5/ 3-G-3,5 RN P20 THR | 1830870 | 50 |
| IMCV 1,5/ 4-G-3,5 RN P20 THR | 1830883 | 50 |
| IMCV 1,5/ 5-G-3,5 RN P20 THR | 1830896 | 50 |
| IMCV 1,5/ 6-G-3,5 RN P20 THR | 1830906 | 50 |
| IMCV 1,5/ 7-G-3,5 RN P20 THR | 1830919 | 50 |
| IMCV 1,5/ 8-G-3,5 RN P20 THR | 1830922 | 50 |
| IMCV 1,5/ 9-G-3,5 RN P20 THR | 1830935 | 50 |
| IMCV 1,5/10-G-3,5 RN P20 THR | 1830948 | 50 |
| IMCV 1,5/11-G-3,5 RN P20 THR | 1830951 | 50 |
| IMCV 1,5/12-G-3,5 RN P20 THR | 1830964 | 50 |

Connector systems with a 3.5/3.81 and 5.08 mm pitch

Single-level header for reflow processes



- 13 to 20 pos. headers with a 3.81 mm pitch
- High-precision pin strips for increased tolerance requirements
- Short 2.0 mm pin for reduced overhang in 1.6 mm PCBs
- You can find user notes and recommendations for the THR procedure in Catalog 1
- For further numbers of positions, visit phoenixcontact.net/products

Notes:

In accordance with DIN EN 61984, COMBICON connectors have no switching power. During designated use, they must not be plugged in or disconnected when carrying voltage or under load.

COMBICON select

Possible combinations for connectors can be found in COMBICON select at phoenixcontact.net/products.

CP-MSTB and SK 3,... may only be used after reflow soldering.

Dimensional drawings of the free space for solder paste, the tape, and pick-and-place pads can be found online at phoenixcontact.net/products.



Pin length 2.0 mm,
Box-packaged headers,
Plug-in direction parallel to the PCB

For accessories, see Catalog 1

| For all types | Type | Page |
|---|---|------|
|  | Coding profile CP-MSTB Order No. 1734634 | |
|  | Marker cards SK 3,5/2,8 or SK 3,81/2,8 | 796 |

Dimensional drawing



Drilling diagram

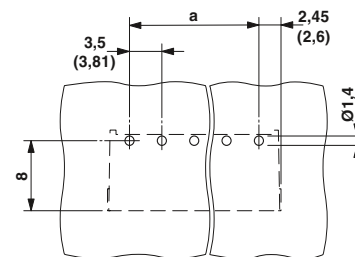

Technical data

Technical data in accordance to IEC / DIN VDE

| | | |
|---|-----------|------------------------|
| Rated current | [A] | 8 |
| Rated insulation voltage for pollution degree 2 | [V] | 160 |
| Pitch | [mm] | 3.81 |
| Insulation coordination | | |
| Surge voltage category / pollution degree | | III / 3 III / 2 II / 2 |
| Rated insulation voltage | [V] | 160 160 250 |
| Rated surge voltage | [kV] | 2.5 2.5 2.5 |
| Approval data (UL/CUL) | Use Group | B C D |
| Nominal voltage | [V] | - - - |
| Nominal current | [A] | - - - |
| Connection capacity AWG | AWG | - - - |
| Approval data (CSA) | Use Group | B C D |
| Nominal voltage | [V] | - - - |
| Nominal current | [A] | - - - |
| Connection capacity AWG | AWG | - - - |
| General data | | |
| Type of insulation material / insulation material group | | LCP / IIIa |
| Inflammability class according to UL 94 | | V0 |
| Drill hole diameter / pin dimensions | [mm] | 1.4 / 0.8 x 0.8 mm |

Ordering data

| Type | Order No. | Pcs. / Pkt. |
|------------------------------------|-----------|-------------|
| 3.81 mm pitch, color: black | | |
| MC 1,5/13-G-3,81 P20 THR | 1829056 | 50 |
| MC 1,5/14-G-3,81 P20 THR | 1829069 | 50 |
| MC 1,5/15-G-3,81 P20 THR | 1829072 | 50 |
| MC 1,5/16-G-3,81 P20 THR | 1829085 | 50 |
| MC 1,5/17-G-3,81 P20 THR | 1829098 | 50 |
| MC 1,5/18-G-3,81 P20 THR | 1829108 | 50 |
| MC 1,5/19-G-3,81 P20 THR | 1829111 | 50 |
| MC 1,5/20-G-3,81 P20 THR | 1829124 | 50 |



Pin length 2.0 mm, with threaded flange
Box-packaged headers,
Plug-in direction parallel to the PCB



Pin length 2.0 mm,
Box-packaged headers,
Plug-in direction vertical to the PCB



Pin length 2.0 mm, with threaded flange
Box-packaged headers,
Plug-in direction vertical to the PCB

Dimensional drawing



Drilling diagram



Ordering data

| Type | Order No. | Pcs. / Pkt. |
|-----------------------------|-----------|-------------|
| 3.81 mm pitch, color: black | | |
| MC 1,5/13-GF-3,81 P20 THR | 1829137 | 50 |
| MC 1,5/14-GF-3,81 P20 THR | 1829140 | 50 |
| MC 1,5/15-GF-3,81 P20 THR | 1829153 | 50 |
| MC 1,5/16-GF-3,81 P20 THR | 1829166 | 50 |
| MC 1,5/17-GF-3,81 P20 THR | 1829179 | 50 |
| MC 1,5/18-GF-3,81 P20 THR | 1829182 | 50 |
| MC 1,5/19-GF-3,81 P20 THR | 1829195 | 50 |
| MC 1,5/20-GF-3,81 P20 THR | 1829205 | 50 |

Dimensional drawing

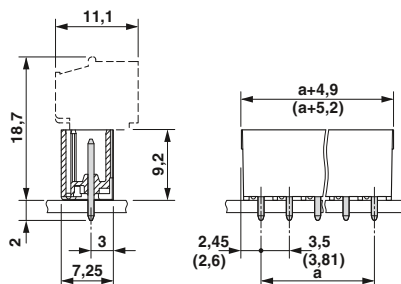

Drilling diagram

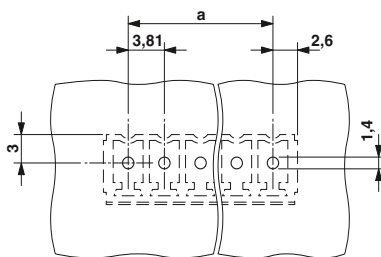

Ordering data

| Type | Order No. | Pcs. / Pkt. |
|-----------------------------|-----------|-------------|
| 3.81 mm pitch, color: black | | |
| MCV 1,5/13-G-3,81 P20 THR | 1828895 | 50 |
| MCV 1,5/14-G-3,81 P20 THR | 1828905 | 50 |
| MCV 1,5/15-G-3,81 P20 THR | 1828918 | 50 |
| MCV 1,5/16-G-3,81 P20 THR | 1828921 | 50 |
| MCV 1,5/17-G-3,81 P20 THR | 1828934 | 50 |
| MCV 1,5/18-G-3,81 P20 THR | 1828947 | 50 |
| MCV 1,5/19-G-3,81 P20 THR | 1828950 | 50 |
| MCV 1,5/20-G-3,81 P20 THR | 1828963 | 50 |

Dimensional drawing

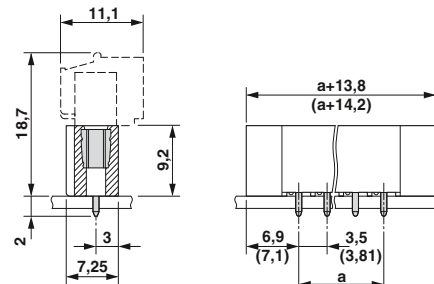

Drilling diagram

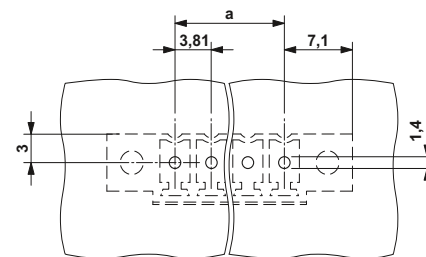

Ordering data

| Type | Order No. | Pcs. / Pkt. |
|-----------------------------|-----------|-------------|
| 3.81 mm pitch, color: black | | |
| MCV 1,5/13-GF-3,81 P20 THR | 1828976 | 50 |
| MCV 1,5/14-GF-3,81 P20 THR | 1828989 | 50 |
| MCV 1,5/15-GF-3,81 P20 THR | 1828992 | 50 |
| MCV 1,5/16-GF-3,81 P20 THR | 1829001 | 50 |
| MCV 1,5/17-GF-3,81 P20 THR | 1829014 | 50 |
| MCV 1,5/18-GF-3,81 P20 THR | 1829027 | 50 |
| MCV 1,5/19-GF-3,81 P20 THR | 1829030 | 50 |
| MCV 1,5/20-GF-3,81 P20 THR | 1829043 | 50 |

Connector systems with a 3.5/3.81 and 5.08 mm pitch

Single-level header for reflow processes



- 13 to 20 pos. headers with a 3.81 mm pitch
- High-precision pin strips for increased tolerance requirements
- Short 2.0 mm pin for reduced overhang in 1.6 mm PCBs
- Tape-on-reel packing according to IEC 60286-3 for automated mounting
- Tape width corresponds to order designation, e.g., R32 = 32 mm tape width
- You can find user notes and recommendations for the THR procedure in Catalog 1
- For further numbers of positions, visit phoenixcontact.net/products

Notes:

In accordance with DIN EN 61984, COMBICON connectors have no switching power. During designated use, they must not be plugged in or disconnected when carrying voltage or under load.

COMBICON select

Possible combinations for connectors can be found in COMBICON select at phoenixcontact.net/products.

CP-MSTB and SK 3,... may only be used after reflow soldering.

Pick and place pads for taped THR articles usually protrude beyond the components. The PCB layout must ensure that collisions are avoided when components are assembled. Dimensional drawings of the pick and place pads can be found online at phoenixcontact.net/products.



Pin length 2.0 mm,
Taped headers,
Plug-in direction parallel to the PCB

For accessories, see Catalog 1

| For all types | Type | Page |
|---|---|------|
|  | Coding profile CP-MSTB Order No. 1734634 | |
|  | Marker cards SK 3,5/2,8 or SK 3,81/2,8 | 796 |

Dimensional drawing



Drilling diagram

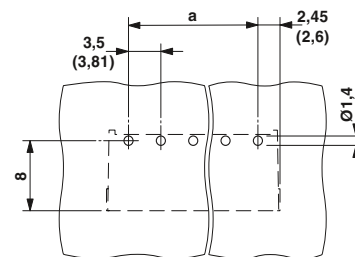

Technical data

Technical data in accordance to IEC / DIN VDE

| | | |
|---|-----------|------------------------|
| Rated current | [A] | 8 |
| Rated insulation voltage for pollution degree 2 | [V] | - |
| Pitch | [mm] | - |
| Insulation coordination | | |
| Surge voltage category / pollution degree | | III / 3 III / 2 II / 2 |
| Rated insulation voltage | [V] | 160 |
| Rated surge voltage | [kV] | |
| Approval data (UL/CUL) | Use Group | B C D |
| Nominal voltage | [V] | - - - |
| Nominal current | [A] | - - - |
| Connection capacity AWG | AWG | - - - |
| Approval data (CSA) | Use Group | B C D |
| Nominal voltage | [V] | - - - |
| Nominal current | [A] | - - - |
| Connection capacity AWG | AWG | - - - |
| General data | | |
| Type of insulation material / insulation material group | | - / - |
| Inflammability class according to UL 94 | | - |

| No. of pos. | Dim. a [mm] |
|-------------|-------------|
| 13 | 45.72 |
| 14 | 49.53 |
| 15 | 53.34 |
| 16 | 57.15 |
| 17 | 60.96 |
| 18 | 64.77 |
| 19 | 68.58 |
| 20 | 72.39 |

Ordering data

| Type | Order No. | Pcs. / Pkt. |
|------------------------------------|-----------|-------------|
| 3.81 mm pitch, color: black | | |
| MC 1,5/13-G-3,81 P20 THRR72 | 1828691 | 470 |
| MC 1,5/14-G-3,81 P20 THRR88 | 1828701 | 470 |
| MC 1,5/15-G-3,81 P20 THRR88 | 1828714 | 470 |
| MC 1,5/16-G-3,81 P20 THRR88 | 1828727 | 470 |
| MC 1,5/17-G-3,81 P20 THRR88 | 1828730 | 470 |
| MC 1,5/18-G-3,81 P20 THRR88 | 1828743 | 470 |
| MC 1,5/19-G-3,81 P20 THRR104 | 1828756 | 470 |
| MC 1,5/20-G-3,81 P20 THRR104 | 1828769 | 470 |



Pin length 2.0 mm, with threaded flange,
Taped headers,
Plug-in direction parallel to the PCB



Pin length 2.0 mm,
Taped headers,
Plug-in direction vertical to the PCB



Pin length 2.0 mm, with threaded flange,
Taped headers,
Plug-in direction vertical to the PCB

Dimensional drawing

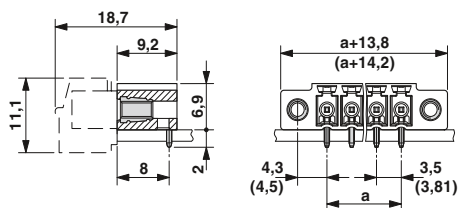

Drilling diagram

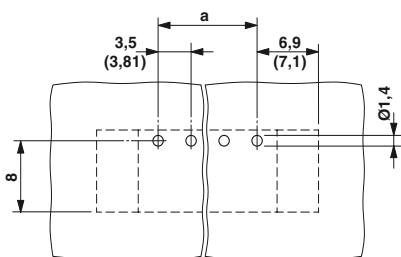

Ordering data

| Type | Order No. | Pcs. / Pkt. |
|-------------------------------|-----------|-------------|
| 3.81 mm pitch, color: black | | |
| MC 1,5/13-GF-3,81 P20 THRR72 | 1828772 | 470 |
| MC 1,5/14-GF-3,81 P20 THRR88 | 1828785 | 470 |
| MC 1,5/15-GF-3,81 P20 THRR88 | 1828798 | 470 |
| MC 1,5/16-GF-3,81 P20 THRR88 | 1828808 | 470 |
| MC 1,5/17-GF-3,81 P20 THRR88 | 1828811 | 470 |
| MC 1,5/18-GF-3,81 P20 THRR88 | 1828824 | 470 |
| MC 1,5/19-GF-3,81 P20 THRR104 | 1828837 | 470 |
| MC 1,5/20-GF-3,81 P20 THRR104 | 1828840 | 470 |

Dimensional drawing



Drilling diagram



Ordering data

| Type | Order No. | Pcs. / Pkt. |
|-------------------------------|-----------|-------------|
| 3.81 mm pitch, color: black | | |
| MCV 1,5/13-G-3,81 P20 THRR72 | 1828536 | 200 |
| MCV 1,5/14-G-3,81 P20 THRR88 | 1828549 | 200 |
| MCV 1,5/15-G-3,81 P20 THRR88 | 1828522 | 200 |
| MCV 1,5/16-G-3,81 P20 THRR88 | 1828565 | 200 |
| MCV 1,5/17-G-3,81 P20 THRR88 | 1828578 | 200 |
| MCV 1,5/18-G-3,81 P20 THRR88 | 1828581 | 200 |
| MCV 1,5/19-G-3,81 P20 THRR104 | 1828594 | 200 |
| MCV 1,5/20-G-3,81 P20 THRR104 | 1828604 | 200 |

Dimensional drawing



Drilling diagram



Ordering data

| Type | Order No. | Pcs. / Pkt. |
|--------------------------------|-----------|-------------|
| 3.81 mm pitch, color: black | | |
| MCV 1,5/13-GF-3,81 P20 THRR72 | 1828617 | 200 |
| MCV 1,5/14-GF-3,81 P20 THRR88 | 1828620 | 200 |
| MCV 1,5/15-GF-3,81 P20 THRR88 | 1828633 | 200 |
| MCV 1,5/16-GF-3,81 P20 THRR88 | 1828646 | 200 |
| MCV 1,5/17-GF-3,81 P20 THRR88 | 1828659 | 200 |
| MCV 1,5/18-GF-3,81 P20 THRR88 | 1828662 | 200 |
| MCV 1,5/19-GF-3,81 P20 THRR104 | 1828675 | 200 |
| MCV 1,5/20-GF-3,81 P20 THRR104 | 1828688 | 200 |



Plug with spring-cage connection up to 0.75 mm²



- Specifically designed for use in reflow and SMT processes
- High current carrying capacity of 6 A
- Robust solder anchor for secure, mechanical fixing to the surface
- Supplied in taped packaging according to IEC 60286-3 for automatic assembly
- Compatible with PTSM...-/PTPM...plugs
- 2.5 mm pitch

| |
|--|
| Notes: |
| PTSM plugs and headers are also available in black. |
| COMBICON select Possible combinations for connectors can be found in COMBICON select at phoenixcontact.net/products . |
| Pick and place pads for taped THR articles usually protrude beyond the components. The PCB layout must ensure that collisions are avoided when components are assembled. Dimensional drawings of the pick and place pads can be found online at phoenixcontact.net/products . |
| 1) Current carrying dependent upon plug used |
| 2) 0.75 mm ² possible, terminates the conductor insulation before the terminal block. |

For accessories, see Catalog 1

| For all types | Type | Page |
|---|--|------|
|  | Screwdriver SZS 0,4 X 2,0 Order No. 1205202 | |
|  | Ferrules with and without plastic sleeve | 834 |
|  | Crimping pliers for 0.25 to 6 mm ² CRIMPFOX 6 Order No. 1212034 | |

Technical data

| | |
|---|---|
| Technical data in accordance to IEC / DIN VDE | |
| Rated current | [A] |
| Rated insulation voltage for pollution degree 2 | [V] |
| Pitch | [mm] |
| Connection capacity | |
| Solid / stranded | [mm ²] / [mm ²] / AWG |
| Stranded with ferrules without plastic sleeve | [mm ²] |
| Stranded with ferrules with plastic sleeve | [mm ²] |
| Insulation coordination | |
| Surge voltage category / pollution degree | |
| Rated insulation voltage | [V] |
| Rated surge voltage | [kV] |
| Approval data (UL/CUL) | Use Group |
| Nominal voltage | [V] |
| Nominal current | [A] |
| Connection capacity AWG | AWG |
| Approval data (CSA) | Use Group |
| Nominal voltage | [V] |
| Nominal current | [A] |
| Connection capacity AWG | AWG |
| General data | |
| Type of insulation material / insulation material group | |
| Inflammability class according to UL 94 | |

| PTSM 0,5/...-HV-2,5-SMD R.. | | | PTSM 0,5/ ...-HTB-2,5-SMD WH R32 | | | PTSM 0,5/ 1-2,5-H SMD WH L R24 | | |
|-----------------------------|---------|--------|----------------------------------|---------|--------|--|---------|--------|
| 6 ¹⁾ | | | 6 ¹⁾ | | | 6 ¹⁾ / 0.5 | | |
| 160 | | | 160 | | | 250 | | |
| 2.5 | | | 2.5 | | | - | | |
| - / - / - | | | - / - / - | | | 0.14 - 0.5 / 0.2 - 0.5 ²⁾ / 26 - 20 | | |
| - | | | - | | | 0.25 - 0.5 | | |
| - | | | - | | | - | | |
| III / 3 | III / 2 | II / 2 | III / 3 | III / 2 | II / 2 | III / 3 | III / 2 | II / 2 |
| 125 | 160 | 250 | 125 | 160 | 250 | 63 | 250 | 320 |
| 2.5 | 2.5 | 2.5 | 2.5 | 2.5 | 2.5 | 2.5 | 2.5 | 2.5 |
| B | C | D | B | C | D | B | C | D |
| - | - | - | - | - | - | 150 | - | - |
| - | - | - | - | - | - | 5 | - | - |
| - | - | - | - | - | - | 26-20 | - | - |
| B | C | D | B | C | D | B | C | D |
| - | - | - | - | - | - | - | - | - |
| - | - | - | - | - | - | - | - | - |
| PA / I | | | PA / I | | | PA / I | | |
| V0 | | | V0 | | | V0 | | |

| No. of pos. | Dim. a [mm] |
|-------------|-------------|
| 1 | |
| 2 | 2.50 |
| 3 | 5.00 |
| 4 | 7.50 |
| 5 | 10.00 |
| 6 | 12.50 |
| 7 | 15.00 |
| 8 | 17.50 |



Vertical header
for SMD applications



Through board header
for SMD applications



1-pos. horizontal PCB terminal block for SMD
applications

Dimensional drawing



Dimensional drawing

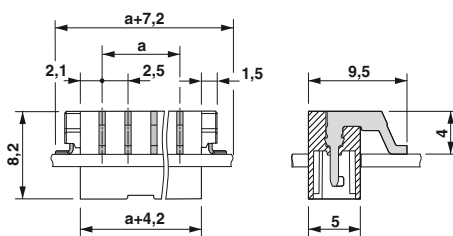

Dimensional drawing

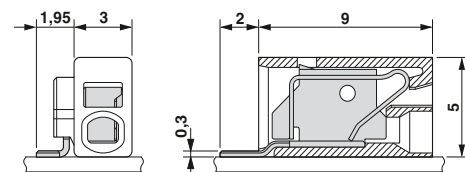

Drilling diagram



Drilling diagram

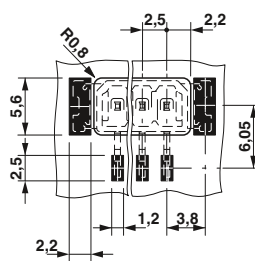

Drilling diagram

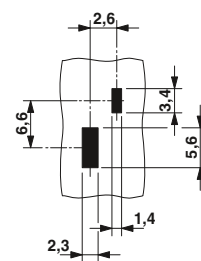

Ordering data

Type
2.5 mm pitch, color: white

Order No. Pcs. / Pkt.

| | | |
|-------------------------------|---------|-----|
| PTSM 0,5/ 2-HV-2,5-SMD WH R32 | 1778696 | 500 |
| PTSM 0,5/ 3-HV-2,5-SMD WH R32 | 1778706 | 500 |
| PTSM 0,5/ 4-HV-2,5-SMD WH R44 | 1778719 | 400 |
| PTSM 0,5/ 5-HV-2,5-SMD WH R44 | 1778722 | 400 |
| PTSM 0,5/ 6-HV-2,5-SMD WH R44 | 1778735 | 400 |
| PTSM 0,5/ 7-HV-2,5-SMD WH R44 | 1778748 | 400 |
| PTSM 0,5/ 8-HV-2,5-SMD WH R44 | 1778751 | 400 |

Ordering data

Type
2.5 mm pitch, color: white

Order No. Pcs. / Pkt.

| | | |
|--------------------------------|---------|-----|
| PTSM 0,5/ 2-HTB-2,5-SMD WH R32 | 1830126 | 330 |
| PTSM 0,5/ 3-HTB-2,5-SMD WH R32 | 1830139 | 330 |
| PTSM 0,5/ 4-HTB-2,5-SMD WH R44 | 1830142 | 330 |
| PTSM 0,5/ 5-HTB-2,5-SMD WH R44 | 1830155 | 330 |
| PTSM 0,5/ 6-HTB-2,5-SMD WH R44 | 1830168 | 330 |
| PTSM 0,5/ 7-HTB-2,5-SMD WH R44 | 1830171 | 330 |
| PTSM 0,5/ 8-HTB-2,5-SMD WH R44 | 1830184 | 330 |

Ordering data

Type
2.5 mm pitch, color: white

Order No. Pcs. / Pkt.

| | | |
|--------------------------------|---------|------|
| PTSM 0,5/ 1-2,5-H SMD WH L R24 | 1840035 | 1000 |
| | | |
| | | |
| | | |
| | | |
| | | |
| | | |

PCB terminal blocks, 7.5 mm pitch

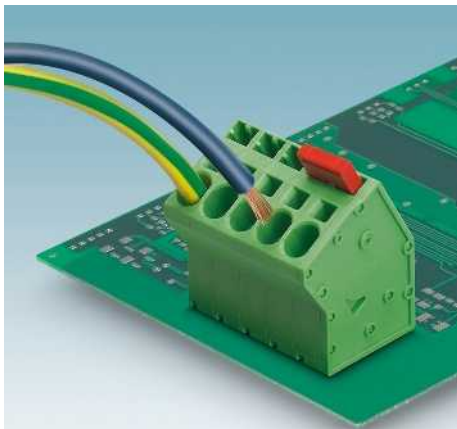





- SPTA 5 PCB terminal block with push-in spring connection for conductor cross sections up to 6 mm² and a current carrying capacity of 41 A
- Fully insulated bridges (FBSK) with different numbers of positions, e.g., for potential distribution
- Fast connection technology, thanks to tool-free direct plug-in principle
- Unrestricted 600-V-UL approval thanks to compact zig-zag pinning
- Conductor connection direction: 30° to the PCB
- Single-position terminal blocks with double pinning

Notes:

When aligning versions with double pinning, other rated insulation voltages can occur.

1) Please observe the current carrying capacity curves and laboratory data sheets. Further current carrying capacity curves on request.

For accessories, see Catalog 1

| For all types | Type | Page |
|--|---|------|
|  | Screwdriver SZF 1-0,6 x 3,5 Order No. 1204517 | |
|  | Crimping pliers for 0.25 to 6 mm ² CRIMPFOX 6 Order No. 1212034 | |
|  | Ferrules with and without plastic sleeve | 834 |
|  | Bridge FBSK ...-7,5 | 830 |

Current carrying capacity curve

Type: SPTA 5/...-7,5

Tested according to DIN EN 60512-5-2:2003-01

Reduction factor = 1

Number of positions: 4

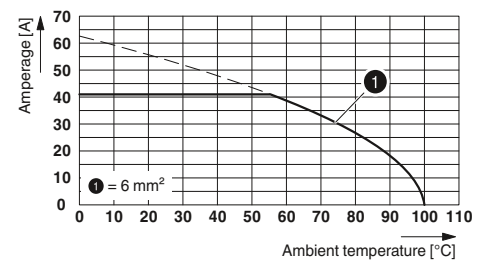

Technical data

| Technical data in accordance to IEC / DIN VDE | |
|--|---|
| Rated current / conductor cross section | [A] / [mm ²] |
| Rated insulation voltage for pollution degree 2 | [V] |
| Pitch | [mm] |
| Connection capacity | |
| Solid / stranded | [mm ²] / [mm ²] / AWG |
| Stranded with ferrules without plastic sleeve | [mm ²] |
| Stranded with ferrules with plastic sleeve | [mm ²] |
| Multi-conductor connection capacity (two conductors with the same cross section) | |
| Solid / stranded | [mm ²] |
| Stranded with ferrules without plastic sleeve | [mm ²] |
| Stranded with TWIN ferrule with plastic sleeve | [mm ²] |
| Insulation coordination | |
| Surge voltage category / pollution degree | |
| Rated insulation voltage | [V] |
| Rated surge voltage | [kV] |
| Approval data (UL/CUL) | Use Group |
| Nominal voltage | [V] |
| Nominal current | [A] |
| Connection capacity AWG | AWG |
| Approval data (CSA) | Use Group |
| Nominal voltage | [V] |
| Nominal current | [A] |
| Connection capacity AWG | AWG |
| General data | |
| Stripping length | [mm] |
| Type of insulation material / insulation material group | |
| Inflammability class according to UL 94 | |
| Drill hole diameter / pin dimensions | [mm] |

SPTA 5/1-7,5

| | | | | | |
|--|--|--|----------------------------|---------|--------|
| Rated current / conductor cross section | | | 41 ¹⁾ / 6 | | |
| Rated insulation voltage for pollution degree 2 | | | 1000 | | |
| Pitch | | | 7.5 | | |
| Connection capacity | | | | | |
| Solid / stranded | | | 0.2 - 6 / 0.2 - 6 / 24 - 8 | | |
| Stranded with ferrules without plastic sleeve | | | 0.25 - 6 | | |
| Stranded with ferrules with plastic sleeve | | | 0.25 - 4 | | |
| Multi-conductor connection capacity (two conductors with the same cross section) | | | | | |
| Solid / stranded | | | - / - | | |
| Stranded with ferrules without plastic sleeve | | | - | | |
| Stranded with TWIN ferrule with plastic sleeve | | | 0.25 - 1.5 | | |
| Insulation coordination | | | | | |
| Surge voltage category / pollution degree | | | III / 3 | III / 2 | II / 2 |
| Rated insulation voltage | | | 630 | 1000 | 1000 |
| Rated surge voltage | | | 6 | 6 | 6 |
| Approval data (UL/CUL) | | | B | C | D |
| Nominal voltage | | | - | - | - |
| Nominal current | | | - | - | - |
| Connection capacity AWG | | | - | - | - |
| Approval data (CSA) | | | B | C | D |
| Nominal voltage | | | - | - | - |
| Nominal current | | | - | - | - |
| Connection capacity AWG | | | - | - | - |
| General data | | | | | |
| Stripping length | | | 15 | | |
| Type of insulation material / insulation material group | | | PA / I | | |
| Inflammability class according to UL 94 | | | V0 | | |
| Drill hole diameter / pin dimensions | | | 2.1 / 1.7 x 0.8 | | |

SPTA 5/...-7,5-ZB

| No. of pos. | Dim. a [mm] |
|-------------|-------------|
| 1 | 0.00 |
| 2 | 7.50 |
| 3 | 15.00 |
| 4 | 22.50 |
| 5 | 30.00 |
| 6 | 37.50 |
| 7 | 45.00 |
| 8 | 52.50 |
| 9 | 60.00 |
| 10 | 67.50 |
| 11 | 75.00 |
| 12 | 82.50 |



Single PCB terminal block, 30° angled connection direction, double pinning



30° angled connection direction, zigzag pinning, 600 V UL approval



Dimensional drawing

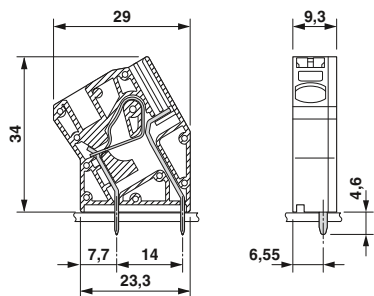

Drilling diagram

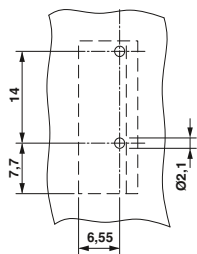

Dimensional drawing

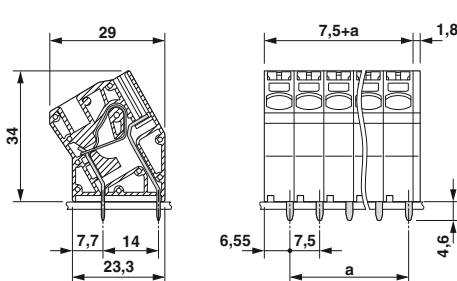

Drilling diagram

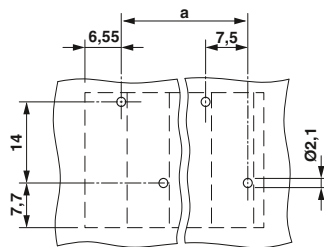

Ordering data

| Type | Order No. | Pcs. / Pkt. |
|----------------------------|-----------|-------------|
| 7.5 mm pitch, color: green | | |

| | | |
|---------------|---------|----|
| SPTA 5/ 1-7,5 | 1819079 | 50 |
|---------------|---------|----|

Ordering data

| Type | Order No. | Pcs. / Pkt. |
|----------------------------|-----------|-------------|
| 7.5 mm pitch, color: green | | |

| | | |
|------------------|---------|----|
| SPTA 5/ 2-7,5-ZB | 1819082 | 50 |
| SPTA 5/ 3-7,5-ZB | 1819095 | 50 |
| SPTA 5/ 4-7,5-ZB | 1819105 | 50 |
| SPTA 5/ 5-7,5-ZB | 1819118 | 50 |
| SPTA 5/ 6-7,5-ZB | 1819121 | 50 |
| SPTA 5/ 7-7,5-ZB | 1819134 | 50 |
| SPTA 5/ 8-7,5-ZB | 1819147 | 50 |
| SPTA 5/ 9-7,5-ZB | 1819150 | 50 |
| SPTA 5/10-7,5-ZB | 1819163 | 50 |
| SPTA 5/11-7,5-ZB | 1819176 | 50 |
| SPTA 5/12-7,5-ZB | 1819189 | 50 |

PCB terminal blocks for power electronics with a pitch from 5.0 to 15.0 mm

PCB terminal blocks, angled, 10 mm pitch

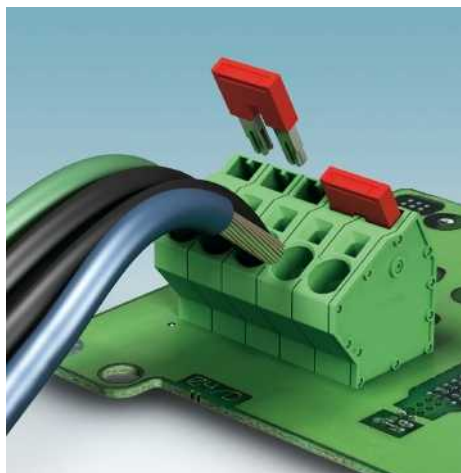



- SPTA 16 PCB terminal block with push-in spring connection for conductor cross sections up to 16 mm² and a current carrying capacity of 76 A
- Fully insulated bridges (FBSK) with different number of positions, e. g. for potential distribution
- Fast connection method thanks to principle of direct plug-in without tools
- Unrestricted 600-V-UL approval thanks to compact zig-zag pinning
- Conductor connection direction: 30° to the PCB
- Single-position terminal blocks with double pinning

Notes:

When aligning versions with double pinning, other rated insulation voltages can occur.

¹⁾ Please observe the current carrying capacity curves and laboratory data sheets. Further current carrying capacity curves on request.

For accessories, see Catalog 1

| For all types | Type | Page |
|--|---|------|
|  | Screwdriver SZF 2-0,8 x4,0 Order No. 1204520 | |
|  | Crimping pliers for 0.25 to 6 mm ² CRIMPFOX 6 Order No. 1212034 | |
|  | Crimping pliers for 10 to 16 mm ² CRIMPFOX 16 S Order No. 1207983 | |
|  | Fixed bridge FBSK ...-10/ZFKDS 10 | 830 |

Current carrying capacity curve

Type: SPTA 16/...-10,0

Tested according to DIN EN 60512-5-2:2003-01

Reduction factor = 1

Number of positions: 4

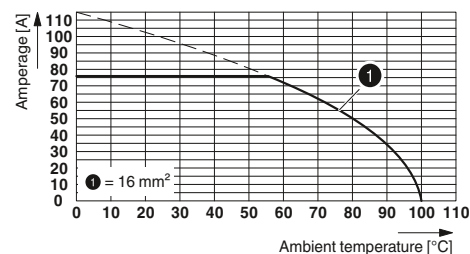

Technical data

| Technical data in accordance to IEC / DIN VDE | |
|--|---|
| Rated current / conductor cross section | [A] / [mm ²] |
| Rated insulation voltage for pollution degree 2 | [V] |
| Pitch | [mm] |
| Solid & multi-strand / stranded | [mm ²] / [mm ²] / AWG |
| Stranded with ferrules without plastic sleeve | [mm ²] |
| Stranded with ferrules with plastic sleeve | [mm ²] |
| Multi-conductor connection capacity (two conductors with the same cross section) | |
| Solid & multi-strand / stranded | [mm ²] |
| Stranded with ferrules without plastic sleeve | [mm ²] |
| Stranded with TWIN ferrule with plastic sleeve | [mm ²] |
| Insulation coordination | |
| Surge voltage category / pollution degree | |
| Rated insulation voltage | [V] |
| Rated surge voltage | [kV] |
| Approval data (UL/CUL) | Use Group |
| Nominal voltage | [V] |
| Nominal current | [A] |
| Connection capacity AWG | AWG |
| Approval data (CSA) | Use Group |
| Nominal voltage | [V] |
| Nominal current | [A] |
| Connection capacity AWG | AWG |
| General data | |
| Stripping length | [mm] |
| Type of insulation material / insulation material group | |
| Inflammability class according to UL 94 | |
| Drill hole diameter / pin dimensions | [mm] |

SPTA 16/1-10,0

| | | | | | |
|--|--|--|--------------------------------|--|--|
| Rated current / conductor cross section | | | 76 ¹⁾ / 10 | | |
| Rated insulation voltage for pollution degree 2 | | | 1000 | | |
| Pitch | | | 10 | | |
| Solid & multi-strand / stranded | | | 0.75 - 10 / 0.75 - 16 / 18 - 4 | | |
| Stranded with ferrules without plastic sleeve | | | 0.75 - 16 | | |
| Stranded with ferrules with plastic sleeve | | | 0.75 - 10 | | |
| Multi-conductor connection capacity (two conductors with the same cross section) | | | | | |
| Solid & multi-strand / stranded | | | - / - | | |
| Stranded with ferrules without plastic sleeve | | | - | | |
| Stranded with TWIN ferrule with plastic sleeve | | | 0.75 - 4 | | |
| Insulation coordination | | | | | |
| Surge voltage category / pollution degree | | | III / 3 III / 2 II / 2 | | |
| Rated insulation voltage | | | 1000 1000 1000 | | |
| Rated surge voltage | | | 8 8 6 | | |
| Approval data (UL/CUL) | | | B C D | | |
| Nominal voltage | | | - | | |
| Nominal current | | | - | | |
| Connection capacity AWG | | | - | | |
| Approval data (CSA) | | | B C D | | |
| Nominal voltage | | | - | | |
| Nominal current | | | - | | |
| Connection capacity AWG | | | - | | |
| General data | | | | | |
| Stripping length | | | 18 | | |
| Type of insulation material / insulation material group | | | PA / I | | |
| Inflammability class according to UL 94 | | | V0 | | |
| Drill hole diameter / pin dimensions | | | 1.7 / 1.2 x 1 | | |

SPTA 16/...-10,0-ZB

| | | | | | |
|--|--|--|--------------------------------|--|--|
| Rated current / conductor cross section | | | 76 ¹⁾ / 10 | | |
| Rated insulation voltage for pollution degree 2 | | | 1000 | | |
| Pitch | | | 10 | | |
| Solid & multi-strand / stranded | | | 0.75 - 10 / 0.75 - 16 / 18 - 4 | | |
| Stranded with ferrules without plastic sleeve | | | 0.75 - 16 | | |
| Stranded with ferrules with plastic sleeve | | | 0.75 - 10 | | |
| Multi-conductor connection capacity (two conductors with the same cross section) | | | | | |
| Solid & multi-strand / stranded | | | - / - | | |
| Stranded with ferrules without plastic sleeve | | | - | | |
| Stranded with TWIN ferrule with plastic sleeve | | | 0.75 - 4 | | |
| Insulation coordination | | | | | |
| Surge voltage category / pollution degree | | | III / 3 III / 2 II / 2 | | |
| Rated insulation voltage | | | 1000 1000 1000 | | |
| Rated surge voltage | | | 8 8 6 | | |
| Approval data (UL/CUL) | | | B C D | | |
| Nominal voltage | | | - | | |
| Nominal current | | | - | | |
| Connection capacity AWG | | | - | | |
| Approval data (CSA) | | | B C D | | |
| Nominal voltage | | | - | | |
| Nominal current | | | - | | |
| Connection capacity AWG | | | - | | |
| General data | | | | | |
| Stripping length | | | 18 | | |
| Type of insulation material / insulation material group | | | PA / I | | |
| Inflammability class according to UL 94 | | | V0 | | |
| Drill hole diameter / pin dimensions | | | 1.7 / 1.2 x 1 | | |

| No. of pos. | Dim. a [mm] |
|-------------|-------------|
| 1 | 0.00 |
| 2 | 10.00 |
| 3 | 20.00 |
| 4 | 30.00 |
| 5 | 40.00 |
| 6 | 50.00 |
| 7 | 60.00 |
| 8 | 70.00 |
| 9 | 80.00 |



Single PCB terminal block,
30° angled connection direction,
double pinning



30° angled connection direction,
zigzag pinning, 600 V UL approval



Dimensional drawing

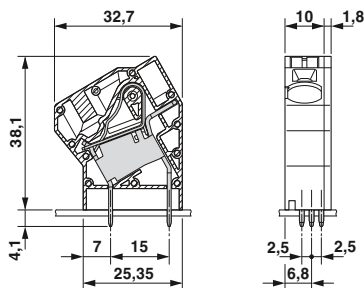

Drilling diagram

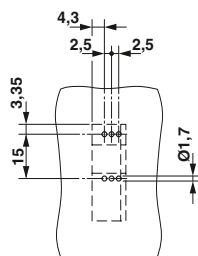

Dimensional drawing

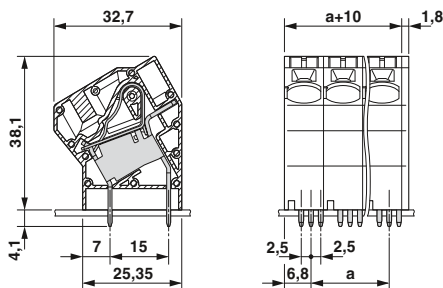

Drilling diagram

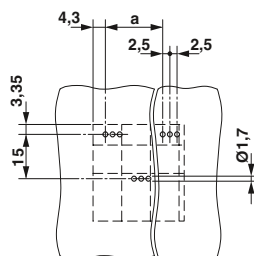

Ordering data

| Type | Order No. | Pcs. / Pkt. |
|---------------------------|-----------|-------------|
| 10 mm pitch, color: green | | |
| SPTA 16/ 1-10,0 | 1819192 | 50 |
| | | |
| | | |
| | | |
| | | |
| | | |
| | | |

Ordering data

| Type | Order No. | Pcs. / Pkt. |
|---------------------------|-----------|-------------|
| 10 mm pitch, color: green | | |
| SPTA 16/ 2-10,0-ZB | 1819202 | 50 |
| SPTA 16/ 3-10,0-ZB | 1819215 | 50 |
| SPTA 16/ 4-10,0-ZB | 1819228 | 50 |
| SPTA 16/ 5-10,0-ZB | 1819231 | 50 |
| SPTA 16/ 6-10,0-ZB | 1819244 | 50 |
| SPTA 16/ 7-10,0-ZB | 1819257 | 50 |
| SPTA 16/ 8-10,0-ZB | 1819260 | 50 |
| SPTA 16/ 9-10,0-ZB | 1819273 | 50 |

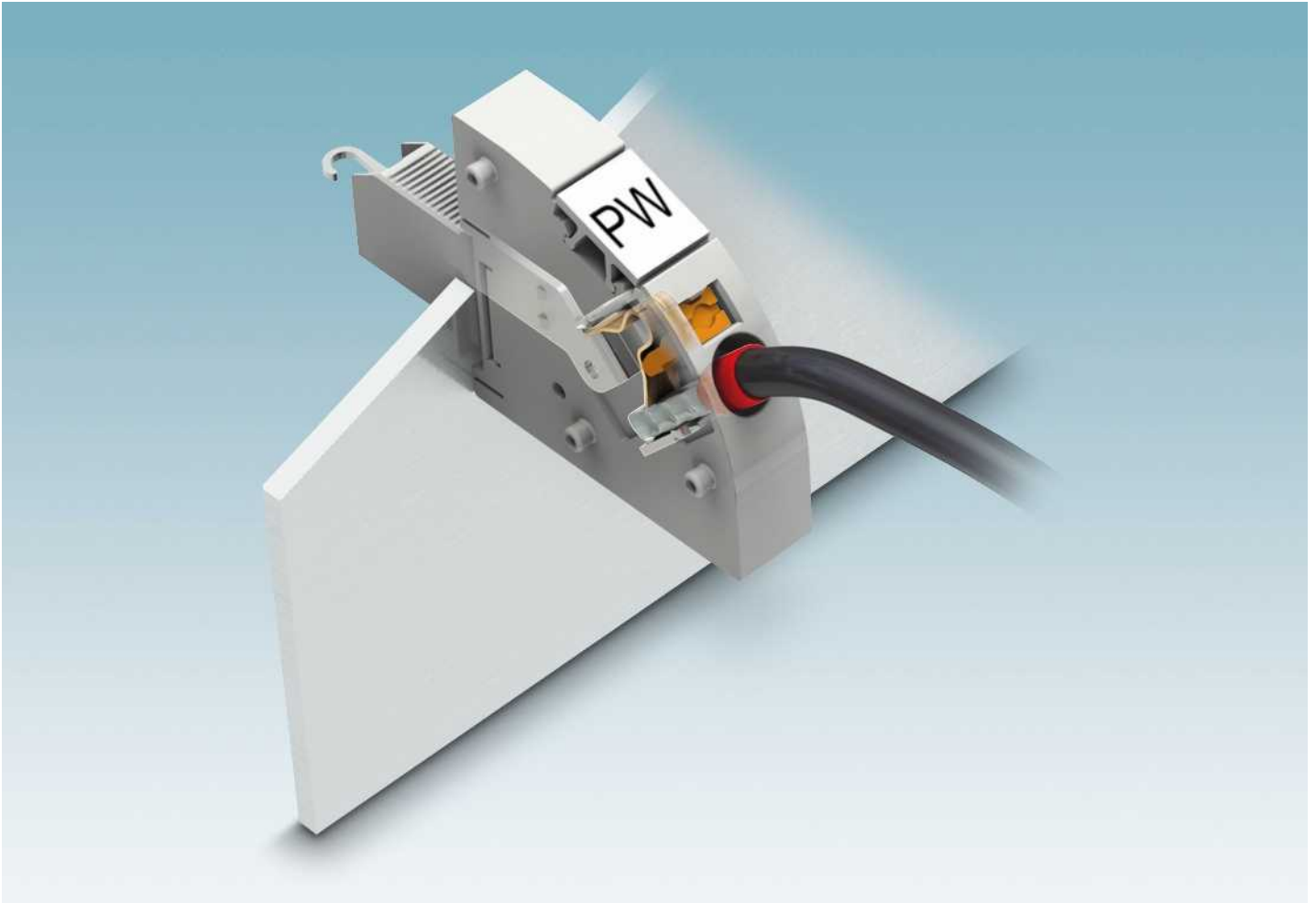

The 45° push-in spring connection enables quick, tool-free, and space-saving connection. The solid conductor or a conductor with ferrule is simply inserted into the terminal point and pressed against the current bar by the spring. It is only when fine-strand conductors without ferrules are connected and when this connection is released that it is necessary to use a standard bladed screwdriver. The perfect connection for rapid wiring in the field.

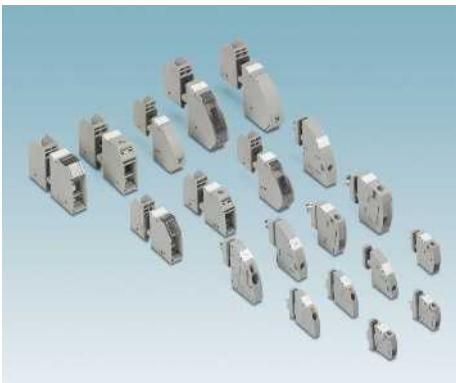

Optimally seal the potting compounds - molded feed-through terminal blocks from Phoenix Contact

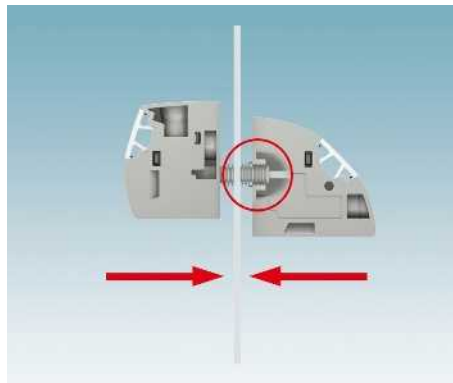

The terminal blocks consist of an internal and external element. These pass through the housing panel and snap together without the need for tools. The engagement mechanism ensures a tight fit, however thick the panel.

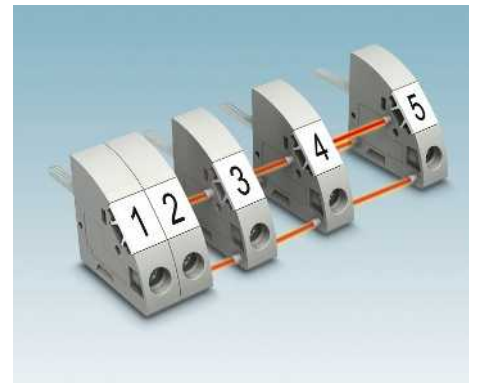

The various engagement pin versions can be used to create pre-assembled blocks for fast mounting.

PWO 16... high-current feed-through terminal blocks with screw connection



- Outside the device with convenient push-in connection
- Inside the device with classic screw connection
- The two halves of the terminal can be easily assembled by simply snapping them together
- Automatic panel thickness compensation
- Flange plates as alternative mounting options

Notes:
 Inside = left side of portrait photos
 Outside = right side of portrait photos
 Corresponding screws for fixing the panel feed-through terminal blocks are supplied as standard.



16 mm² panel feed-through terminal block, external part with push-in connection, internal part with screw connection

Accessories

| For all types | Type | |
|---|--|--|
|  | Flange plate PWO 16-F Order No. 1705659 | |

Dimensional drawing

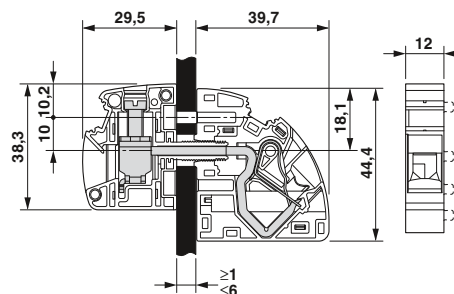

Drilling diagram

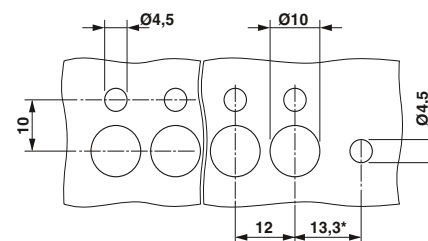

Technical data

| | | | | |
|--|---|------------------------------|---------|--------|
| Technical data in accordance to IEC / DIN VDE | | | | |
| Current/conductor cross section | [A] / [mm ²] | 76 / 16 // 76 / 16 | | |
| Rated voltage | [V] | 1000 | | |
| Connection capacity | | | | |
| Solid / stranded | [mm ²]/[mm ²]/AWG | 1.5 - 16 / 1.5 - 16 / 14 - 4 | | |
| Stranded with ferrules without plastic sleeve | [mm ²] | 1.5 - 16 | | |
| Stranded with ferrules with plastic sleeve | [mm ²] | 1.5 - 16 | | |
| Multi-conductor connection capacity (two conductors with the same cross section) | | | | |
| Solid / stranded | [mm ²] | - / - | | |
| Stranded with ferrules without plastic sleeve | [mm ²] | - | | |
| Stranded with TWIN ferrule with plastic sleeve | [mm ²] | 1.5 - 4 | | |
| Cross section with insertion bridge (solid/stranded) | [mm ²] | - / - | | |
| Insulation coordination | | | | |
| Surge voltage category / pollution degree | | III / 3 | III / 2 | II / 2 |
| Rated insulation voltage | [V] | 800 | 1000 | 1000 |
| Rated surge voltage | [kV] | 6 | 6 | 6 |
| Approval data (UL/CUL) | Use Group | B | C | D |
| Nominal voltage | [V] | - | - | - |
| Nominal current | [A] | - | - | - |
| Connection capacity AWG | AWG | - | - | - |
| Approval data (CSA) | Use Group | B | C | D |
| Nominal voltage | [V] | - | - | - |
| Nominal current | [A] | - | - | - |
| Connection capacity AWG | AWG | - | - | - |
| General data | | | | |
| Stripping length | [mm] | 18 | | |
| Cable lug connection: thread / tightening torque | | | | |
| Insulation material | | PA | | |
| Inflammability class according to UL 94 | | V0 | | |
| Panel thickness | [mm] | 1 - 6 | | |

Ordering data

| Type | Order No. | Pcs. / Pkt. |
|--|-----------|-------------|
| Panel feed-through terminal block | | |
| PWO 16-UW | 1844387 | 50 |
| Panel feed-through terminal block, with engagement pin | | |
| PWO 16-UW/S | 1844390 | 50 |

ZB 12.../ZBF 12... marking material (see Catalog 5)

TMT (EX9,5)R marking material (see online catalog)



The ME-IO housing is particularly suitable for applications with a small amount of installation space. The push-in front connection technology as well as the compact design enable devices with up to 36 positions to be implemented in a confined space.



The Lock & Release system provides secure and defined locking and release for plugs and headers.

Releasing the lever automatically ejects the plug from the header. The contact system between the plug and header is interrupted, but the plugs do not fall out.

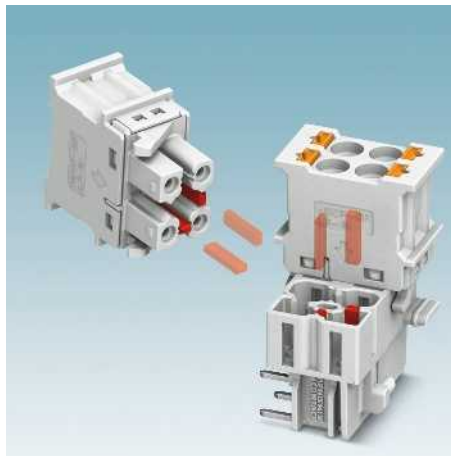

Coding with CP-DMC... coding profile prevents mismatching in the device.

The HSCP-... plugs and HSCH ... headers are mounted with corresponding CP-DMC ... coding profiles. If the coding profile is mounted between the same positions, the plug cannot be plugged in.

The coding can be implemented later on site or is provided in pre-assembled versions.



The ME 18,8 TBUS connector can be snapped onto the NS 35/7,5 DIN rail to connect individual modules together. This means that the signal and supply voltage can be implemented in the device system without any wiring.

The bus connector is compatible with the bus system of the ME TBUS and ME MAX housing ranges, thereby enabling the creation of complex devices with quick and convenient mounting.



Flexible modular principle

The flexible housing concept of ME-IO offers numerous solutions. Thanks to the variety of covering hoods, plugs, and headers, there is no doubt a solution for your special requirements.

An overview of predefined assembly versions is shown on the next page.

Lock & Release

The Lock & Release system is available in four lengths. It is available in 3, 5, 7, and 9 units. The length of Lock & Release defines the possible plug area.

Various covering hoods

Covering hoods are available in lengths from 2 to 7 units. This means that the appropriate hood can be used for display and operating elements as well as data connectors.

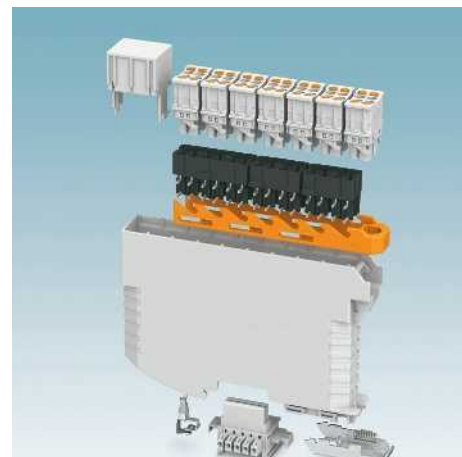

Plug version with TWIN connection

The TWIN connector is characterized by the connection of two conductors to one connection terminal. It is used to loop through signals or to distribute potential or power.

The 2 and 4-pos. plug versions can be flexibly combined for sophisticated device solutions.

Color options for the plug

The spring levers of plugs can also be produced in other standard colors. This enables easy conductor/terminal point assignment during installation.

The plug and electronics housing can be produced in non-standard colors as well.



Exploded view of the ME-IO housing system

Matrix for selection

| | | | Example 1 | | | Example 2 | | | Example 3 | | |
|---|-----------|--------------------------------|----------------------------|------------------------------|---------------|----------------------------|-----------------------------|---------------|------------------------------|-----------|--|
| | | | | | | | | | | | |
| | | | 28-pos. | 20-pos. + 4 TWIN connections | 26-pos. | 24-pos. | 6-pos. + 4 TWIN connections | 22-pos. | 12-pos. + 2 TWIN connections | | |
| | | | Quantity (fitted position) | | | Quantity (fitted position) | | | Quantity (fitted position) | | |
| Lower housing part with Lock & Release | | | | | | | | | | | |
| | Order No. | Type | | | | | | | | | |
| | 2201960 | ME-IO 18,8 B/FE 9/9U TBUS 7035 | 1 x | 1 x | 1 x | 1 x | 1 x | 1 x | 1 x | | |
| | 2201961 | ME-IO 18,8 B/FE 7/9U TBUS 7035 | | | | | | | | | |
| | 2201962 | ME-IO 18,8 B/FE 5/9U TBUS 7035 | | | | | | | | | |
| | 2201963 | ME-IO 18,8 B/FE 3/9U TBUS 7035 | | | | | | | | | |
| Covering hood | | | | | | | | | | | |
| | 2201799 | ME-IO 18,8 C 2U 7035 | 1 x (8-9) | 1 x (8-9) | 1 x (8-9) | | | | | 1 x (8-9) | |
| | 2201800 | ME-IO 18,8 C 3U 7035 | | | | 1 x (7-9) | 1 x (7-9) | 1 x (7-9) | | | |
| | 2201801 | ME-IO 18,8 C 3U S1 7035 | | | | | | | | 1 x (2-4) | |
| | 2201802 | ME-IO 18,8 C 4U 7035 | | | | | | | | | |
| | 2201803 | ME-IO 18,8 C 5U 7035 | | | | | | | | | |
| | 2201804 | ME-IO 18,8 C 6U 7035 | | | | | | | | | |
| | 2201805 | ME-IO 18,8 C 7U 7035 | | | | | | | | | |
| Header | | | | | | | | | | | |
| | 2201788 | HSCH 2,5-3U/12 9005 | 1 x (5-7) | 1 x (5-7) | 1 x (5-7) | | | | | 1 x (5-7) | |
| | 2201789 | HSCH 2,5-2U/ 8 9005 | 2 x (1-4) | 1 x (3-4) | 1 x (1-2) | 3 x (1-6) | 2 x (3-6) | 2x(1-2 & 5-6) | | | |
| | 2201790 | HSCH 2,5-2U-TTTT 9005 | | 1 x (1-2) | | | 1 x (1-2) | | | | |
| | 2201791 | HSCH 2,5-2U-TT00 9005 | | | | | | | | 1 x (1-2) | |
| | 2201792 | HSCH 2,5-2U-2220 9005 | | | 1 x (3-4) | | | | 1 x (3-4) | | |
| Plug with push-in spring connection | | | | | | | | | | | |
| | 2201780 | HSCP-SP 2,5-1U/ 4 7035 | 7 x (1-7) | 5 x (3-7) | 6x(1-3 & 5-7) | 6 x (1-6) | 4 x (3-6) | 5x(1-3 & 5-6) | 3 x (5-7) | | |
| | 2201781 | HSCP-SP 2,5-1U-TT 7035 | | 2 x (1-2) | | | 2 x (1-2) | | 1 x (1) | | |
| | 2201782 | HSCP-SP 2,5-1U-20 7035 | | | 1 x (4) | | | | 1 x (4) | | |

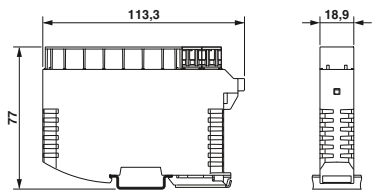
Notes:
 For the functionality of the Lock & Release system, note the positioning of the header. A side-by-side arrangement of the HSCH 2,5-3U/12 9005 header is not possible.
 In the examples, the quantities of covering hoods, headers, and plugs and their respective position for fitting are specified.
 Data sheets for the housing system with connectors are available at phoenixcontact.net/products.
 Numerous other configurations are possible.

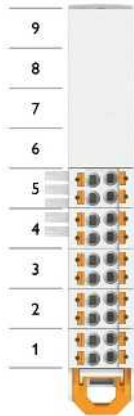
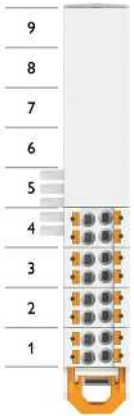
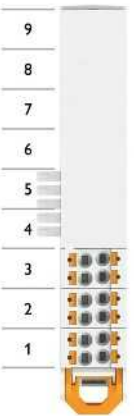

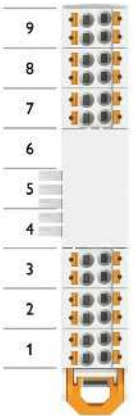
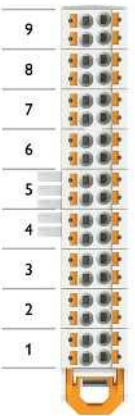
| Example 4 | | | Example 5 | | | Example 6 | Example 7 | | Example 8 | Example 9 |
|---|------------------------------|--------------------------|---|-----------------------------|--------------------------|---|--|--------------------|---|---|
|  | | |  | | |  |  | |  |  |
| 20-pos. | 12-pos. + 4 TWIN connections | 18-pos. | 16-pos. | 8-pos. + 4 TWIN connections | 14-pos. | 12-pos. | 8-pos. | 4 TWIN connections | 24-pos. | 36-pos. |
| Quantity (fitted position) | | | Quantity (fitted position) | | | Quantity (fitted position) | Quantity (fitted position) | | Quantity (fitted position) | Quantity (fitted position) |
| | | | | | | | | | 1 x | 1 x |
| 1 x | 1 x | 1 x | 1 x | 1 x | 1 x | 1 x | 1 x | 1 x | | |
| | | | | | | | | | 1 x (4-6) | |
| 1 x (6-9) | 1 x (6-9) | 1 x (6-9) | 1 x (5-9) | 1 x (5-9) | 1 x (5-9) | 1 x (4-9) | 1 x (3-9) | 1 x (3-9) | | |
| 1 x (3-5) | 1 x (3-5) | 1 x (3-5) | | | | 1 x (1-3) | | | 2 x (1-3 & 7-9) | 1 x (7-9) |
| 1 x (1-2) | 1 x (1-2) | | 2 x (1-4) | 1 x (3-4) | 1 x (3-4) | | 1 x (1-2) | 1 x (1-2) | | 3 x (1-6) |
| | | 1 x (1-2) | | | 1 x (1-2) | | | | | |
| 5 x (1-5) | 3 x (3-5) 2 x (1-2) | 4 x (1 & 3-5) 1 x (2) | 4 x (1-4) | 2 x (3-4) 2 x (1-2) | 3 x (1 & 3-4) 1 x (2) | 3 x (1-3) | 2 x (1-2) | 2 x (1-2) | 6 x (1-3 & 7-9) | 9 x (1-9) |



ME-IO... electronics housing with front connection



Mounting principle:

- Electronic components and HSC headers can be assembled and soldered in a single step.
- Lock & Release and headers are snapped in. The pressure springs are inserted in the rear grips provided.
- The PCB can be easily snapped into the housing thanks to the guide edges in the lower housing part.
- The covering hood is placed on the free area and snapped into the HSC headers.
- The HSC plugs are marked with an arrow to indicate the plug-in direction.

HSC headers and plugs:

The headers are available in two and three-unit sizes and the plugs in one unit. Two plugs fit on the HSCH 2,5-2U... and three plugs fit on the HSCH 2,5-3U...

The HSC headers differ with regard to the number of terminal points and require the relevant plug versions:

- 12 terminal points – 3 x 4-pos.
- 8 terminal points – 2 x 4-pos.
- 6 terminal points – 1 x 4-pos. and 1 x 2-pos.
- 4 terminal points – 2 x 2 TWIN connections
- 2 terminal points – 1 x 2 TWIN connections and ME-IO 18,8 C 3U S1 7035

Notes:

Additional housing dimensions and details of PCB layout, dimensions, and assembly areas can be found in the download center at: phoenixcontact.net/products



Width: 18.8 mm

Description

Housing base, pre-assembled, with metal foot catch, with integrated functional earth ground contact, without TBUS plug, color: light gray, including Lock & Release in

3 units
5 units
7 units
9 units

Covering hood, in various units, color: light gray

2 units, dimension a = 22 mm
3 units, dimension a = 33 mm
3 units, for covering 1 unit header, dimension a = 33 mm

4 units, dimension a = 44 mm
5 units, dimension a = 55 mm
6 units, dimension a = 66 mm
7 units, dimension a = 77 mm

HSC header, touch proof, in 2 units, color: black

8 connections
4 connections
2 connections
6 connections

HSC header, touch proof, in 3 units, color: black, please note the positioning

12 connections

HSC push-in plug, for touch-proof HSC headers, in 1 unit, with integrated test connection, color: light gray

4-pos.
Partially assembled, 2-pos.
2 TWIN connections

DIN rail connector, 5-pos.

Coding profile, for header and push-in plug, color: natural

Ordering data

| Type | Order No. | Pcs. / Pkt. |
|--------------------------------|-----------|-------------|
| ME-IO 18,8 B/FE 3/9U TBUS 7035 | 2201963 | 10 |
| ME-IO 18,8 B/FE 5/9U TBUS 7035 | 2201962 | 10 |
| ME-IO 18,8 B/FE 7/9U TBUS 7035 | 2201961 | 10 |
| ME-IO 18,8 B/FE 9/9U TBUS 7035 | 2201960 | 10 |

Accessories

| Type | Order No. | Pcs. / Pkt. |
|------|-----------|-------------|
| | | |

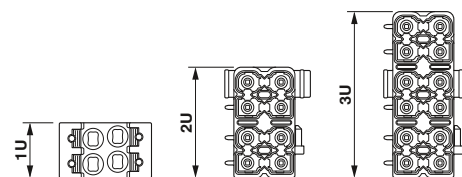



Width: 18.8 mm



Touch-proof headers



Connector plugs for touch-proof headers

Ordering data

| Type | Order No. | Pcs. / Pkt. |
|-------------------------|-----------|-------------|
| ME-IO 18,8 C 2U 7035 | 2201799 | 10 |
| ME-IO 18,8 C 3U 7035 | 2201800 | 10 |
| ME-IO 18,8 C 3U S1 7035 | 2201801 | 10 |
| ME-IO 18,8 C 4U 7035 | 2201802 | 10 |
| ME-IO 18,8 C 5U 7035 | 2201803 | 10 |
| ME-IO 18,8 C 6U 7035 | 2201804 | 10 |
| ME-IO 18,8 C 7U 7035 | 2201805 | 10 |

Ordering data

| Type | Order No. | Pcs. / Pkt. |
|-----------------------|-----------|-------------|
| HSCH 2,5-2U/ 8 9005 | 2201789 | 50 |
| HSCH 2,5-2U-TTTT 9005 | 2201790 | 50 |
| HSCH 2,5-2U-TT00 9005 | 2201791 | 50 |
| HSCH 2,5-2U-2220 9005 | 2201792 | 50 |
| HSCH 2,5-3U/12 9005 | 2201788 | 50 |

Ordering data

| Type | Order No. | Pcs. / Pkt. |
|------------------------|-----------|-------------|
| HSCP-SP 2,5-1U/ 4 7035 | 2201780 | 50 |
| HSCP-SP 2,5-1U-TT 7035 | 2201781 | 50 |
| HSCP-SP 2,5-1U-20 7035 | 2201782 | 50 |

Accessories

| Type | Order No. | Pcs. / Pkt. |
|------|-----------|-------------|
| | | |

Accessories

| Type | Order No. | Pcs. / Pkt. |
|------|-----------|-------------|
| | | |

Accessories

| Type | Order No. | Pcs. / Pkt. |
|--------------------------------|-----------|-------------|
| ME 18,8 TBUS 1,5/5-ST-3,81KMGY | 2201813 | 50 |
| CP-DMC 1,5-THR NAT | 1790647 | 60 |

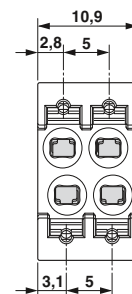
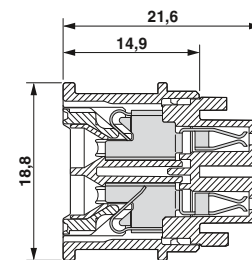
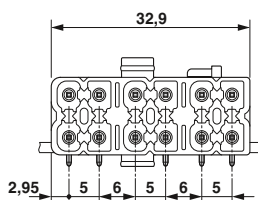
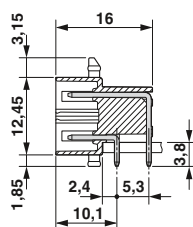
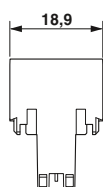
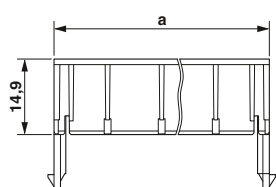

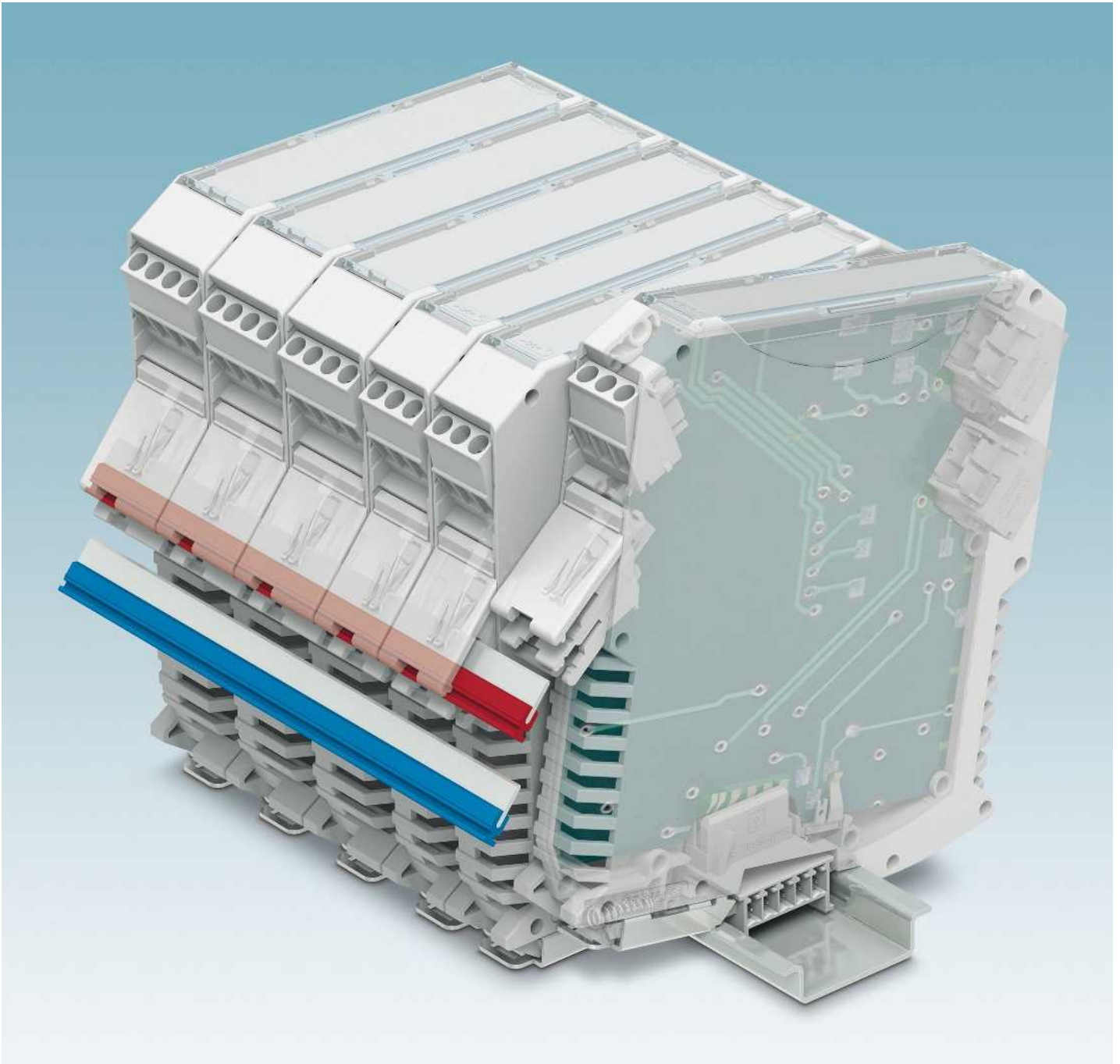

Together with the PBR jumper, the new PCO power connector enables the transmission of high levels of power between modules in ME MAX housings.

The new ME TBUS 4P1S enables the easy implementation of serial and parallel circuits for module-to-module connection in the DIN rail.

The ME TBUS ADAPTER allows even more effective use of ME TBUS technology for modules with a design width from 35 mm. ME TBUS 4P1S and the ME TBUS ADAPTER can be used in ME and ME MAX housings.

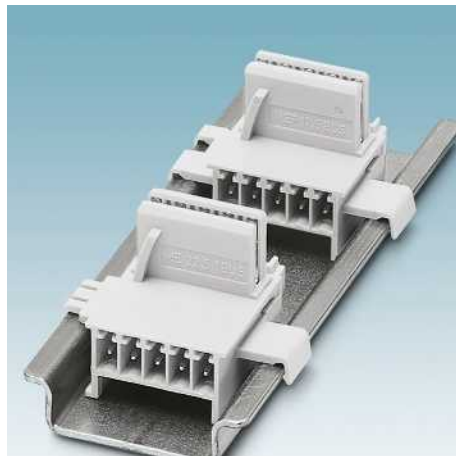
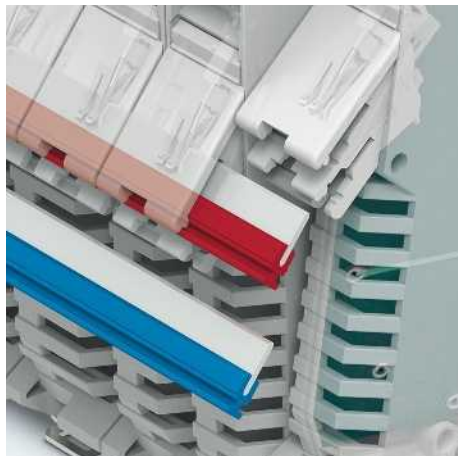

PCO... power connector for ME MAX housing

The PCO power connector is used to transmit power of up to 42 A (8 A per module) and 60 V DC between modules in ME MAX housings. There are no restrictions on the mounting and removal of modules from the group while in the off-load state.

The PCO connector can be soldered to other electronic components in the wave soldering process. For additional information, please refer to the data sheets at phoenixcontact.net/products. Cross connection is achieved by simply inserting the PBR jumper.

ME... TBUS 4P1S: serial and parallel connection in the DIN rail

The ME TBUS 4P1S enables the serial and parallel connection of modules via the DIN rail: 4 positions are intended for parallel circuits and 1 position for serial circuits.

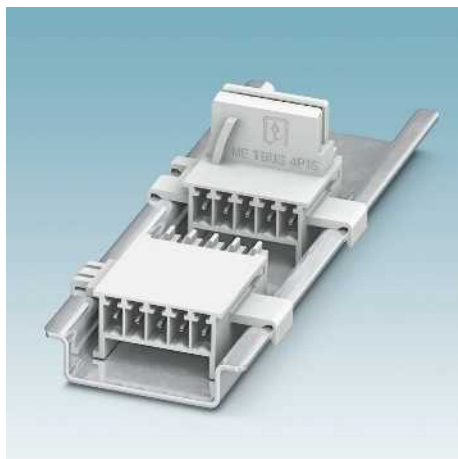

ME TBUS ADAPTER: easy extension

From a housing width of 35 mm, the ME TBUS ADAPTER is the ideal solution for the efficient use of the TBUS system.

In addition, by using the ME TBUS ADAPTER there is more PCB area available for mounting in the housing as there is no T-tap.

PCO... power connector for ME MAX housing



The PCO... power connector can be used together with the PBR... jumper in ME MAX housing.

Technical data:

- Voltage up to 60 V DC
- Total current of 42 A
- 8 A per module
- 2-pos.
- With orthogonal pin outlet
- Designed for parallel connections
- ME MAX connection technology and accessories can also be used without restriction



| Description |
|---|
| Power bus connector , suitable for ME MAX 17,5, ME MAX 35, 2-pos., color: light gray |
| Power bus connector , suitable for ME MAX 22,5, ME MAX 45, ME MAX 67,5, and ME MAX 90; 2-pos.; color: light gray |

| |
|---|
| Jumper , for connecting device modules when using power bus connectors; can be cut to length using diagonal cutter; supplied length: 500 mm; Color: light gray Color: blue Color: red |
|---|

Ordering data

| Type | Order No. | Pcs. / Pkt. |
|-----------------|-----------|-------------|
| PCO 17,5-L KMGY | 2201684 | 50 |
| PCO 22,5-L KMGY | 2201685 | 50 |

Accessories

| | | |
|--------------|---------|----|
| PBR 42A KMGY | 2201917 | 10 |
| PBR 42A BU | 2201916 | 10 |
| PBR 42A RD | 2201915 | 10 |

ME TBUS 4P1S and ME TBUS ADAPTER for ME and ME MAX housing

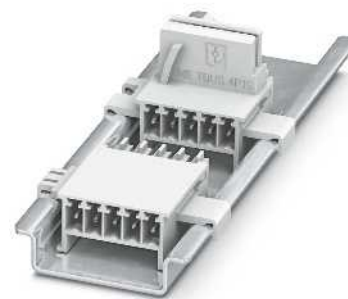

The ME... TBUS 4P1S enables the implementation of parallel circuits together with serial circuits, which connect various modules on the DIN rail in ME and ME MAX housings.

Technical data:

- Voltage up to 50 V
- Currents up to 8 A per position
- 4 parallel positions
- 1 serial position

The ME... TBUS ADAPTER is particularly useful for using wider modules in the ME and ME MAX housing more efficiently together with the ME... TBUS.

Technical data:

- Voltage up to 125 V
- Currents up to 8 A per position
- 5 parallel positions
- No tap in the electronics housing

| Description | No. of pos. |
|--|-------------|
| ME TBUS connector , suitable for ME and ME MAX housing, 5 positions (4 parallel positions and 1 serial position); color: light gray | |
| 17.5 mm design width | 5 |
| 22.5 mm design width | 5 |
| Adapter for extending the ME TBUS connector , suitable for ME and ME MAX housing, 5 parallel positions; color: light gray | |
| 17.5 mm design width | 5 |
| 22.5 mm design width | 5 |

| Ordering data | | |
|-----------------------------------|----------------|-------------|
| Type | Order No. | Pcs. / Pkt. |
| ME 17,5 TBUS 1,5/4P1S KMGY | 2201731 | 50 |
| ME 22,5 TBUS 1,5/4P1S KMGY | 2201732 | 50 |
| ME 17,5 TBUS ADAPTER KMGY | 2201757 | 50 |
| ME 22,5 TBUS ADAPTER KMGY | 2201756 | 50 |



RJ45 industrial connectors, IP20
Page 44



Push-pull industrial connectors, version 14
with RJ45 insert
Page 46



Push-pull industrial connectors, version 14
with FO insert
Page 48



Modular distribution panel, panel mounting
frame
Page 50



M12 device connectors XL
Page 54



M12 power device connectors
Page 56



M23 cable and coupler connectors, hybrid,
SPEEDCON fast locking system
Page 63



M23 device connectors, hybrid
Page 64



SUNCLIX micon, AC-Y connectors
Page 70



SUNCLIX micon, mains connector plugs
Page 70

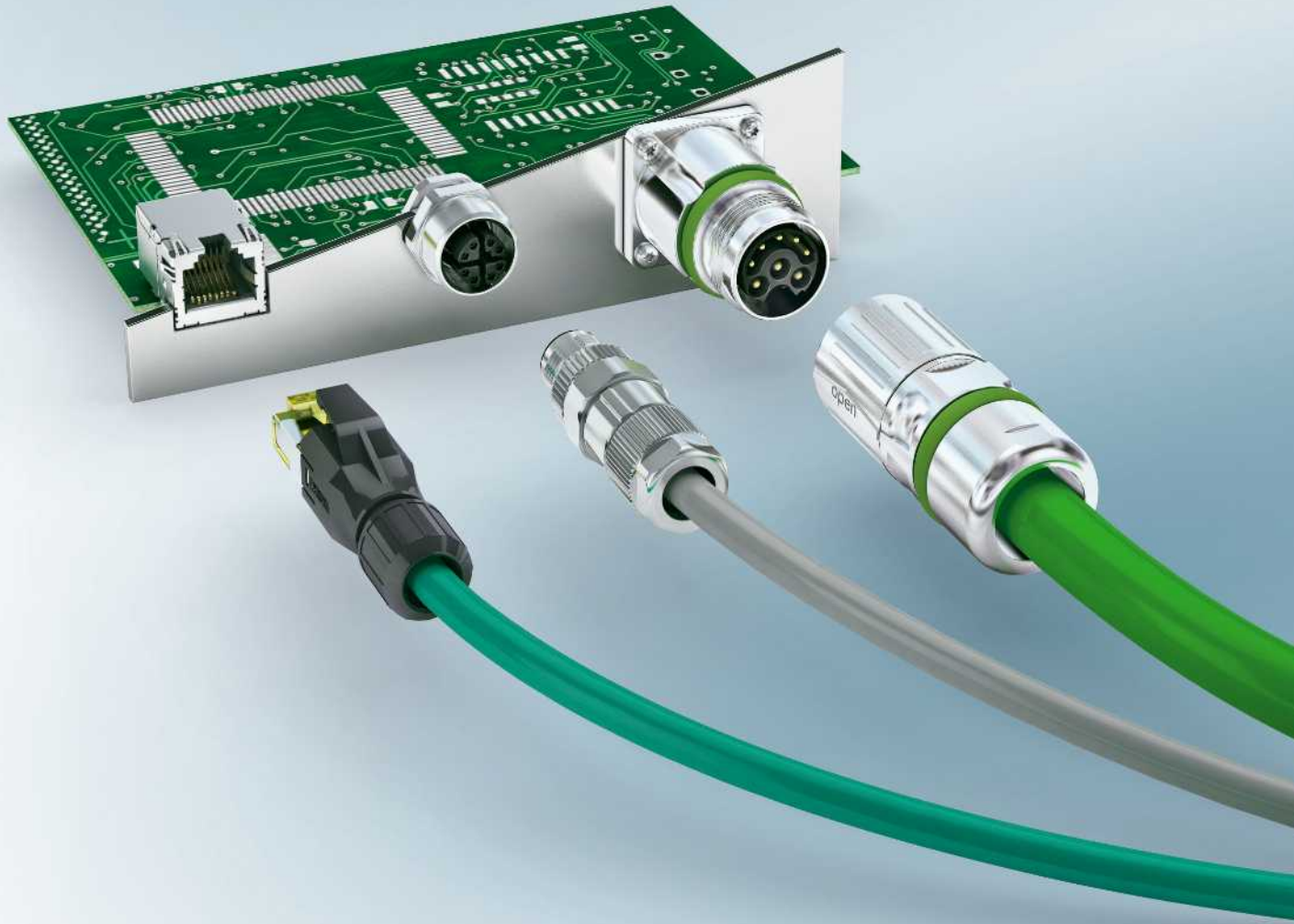

Photovoltaic AC connectors

Page 76



AC charging cables

Page 80



Mobile AC charging cables

Page 83



Combined charging system charging cables

Page 84

Connection technology for field devices

Data connectors

Unique variety for copper and fiber optics

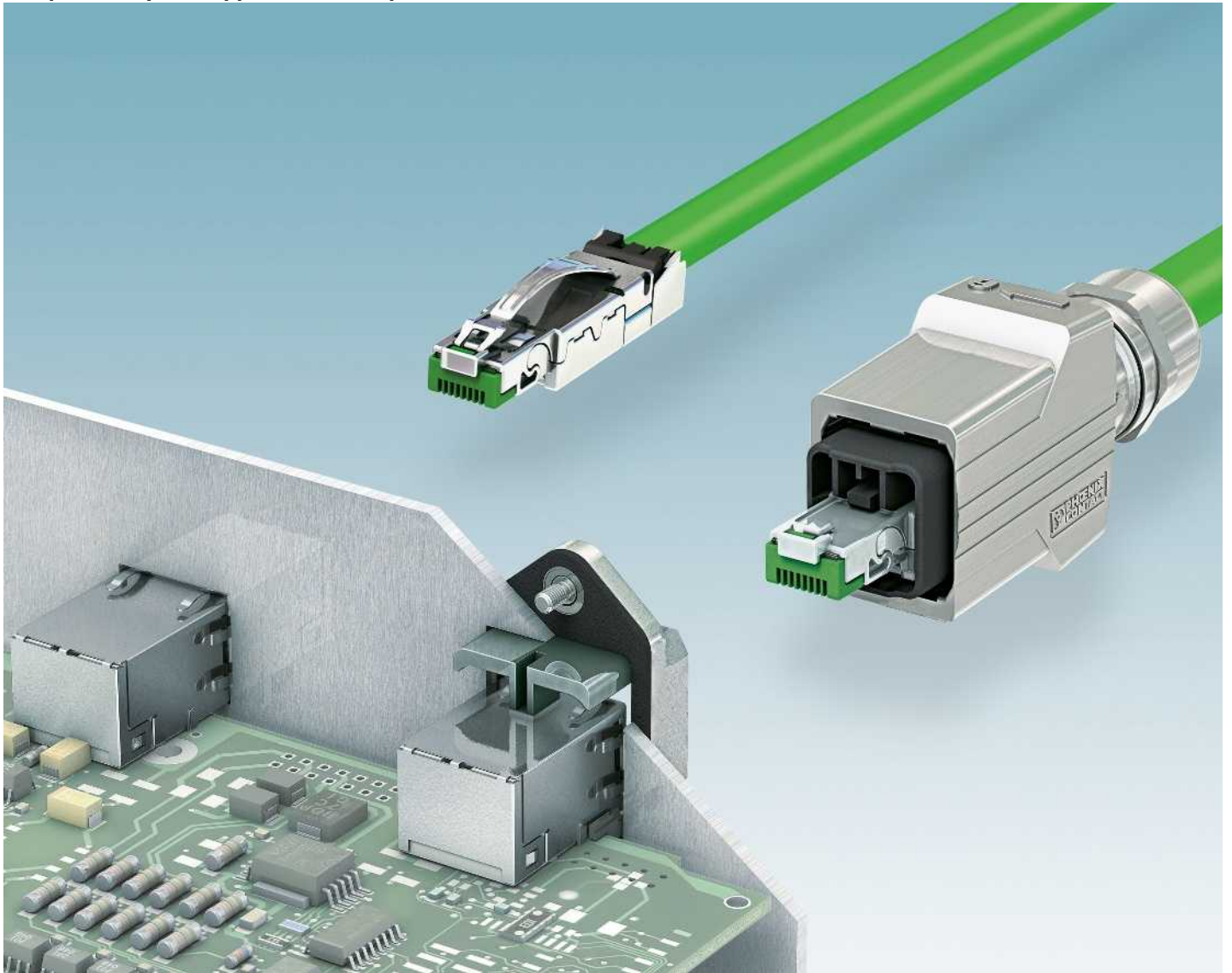

For compact device connection



For flexible cable connection



For easy cabling

The right connection for every application



Modern industrial automation requires connectors for large quantities of data in robust packaging. Benefit now from powerful connectors and cables for on-site assembly.



High requirements are placed on components used for outdoor data transmission, in fields such as telecommunications, renewable energies, and offshore applications. Whether you're concerned about UV, temperature or humidity, the connectors from Phoenix Contact offer ideal protection.



Phoenix Contact offers an extensive and forward-looking product range for modern building cabling which impresses with its easy installation. Our patch cables and patch fields allow you to install flexible and fault-tolerant cabling.

The right connection technology for every application



Fast assembly without special tools
– with IDC and Piercecon® fast connection



Fast assembly in the field
using professional tools

Connection technology for field devices

Data connectors – RJ45 connectors

RJ45 industrial connectors, IP20

- Optimized for industrial use with a high degree of resistance to vibration
- High resistance to ESD and EMI for reliable transmission
- Easy handling, thanks to one-piece design
- Metal locking



RJ45 industrial, straight cable outlet



RJ45 industrial, cable outlet at the top

| | Technical data | | | | Technical data | | | |
|---|----------------------|-------------|-------------------|-------------|----------------------|-------------|-------------------|-------------|
| | Ethernet printing | | PROFINET printing | | Ethernet printing | | PROFINET printing | |
| Degree of protection | IP20 | | IP20 | | IP20 | | IP20 | |
| Connection cross section AWG | 26 ... 24 | | 23 ... 22 | | 26 ... 24 | | 23 ... 22 | |
| Transmission speed | 10 Gbps | | 1 Gbps | | 10 Gbps | | 1 Gbps | |
| Housing material | Zinc die-cast | | Zinc die-cast | | Zinc die-cast | | Zinc die-cast | |
| External cable diameter | 5 mm ... 9 mm | | 5 mm ... 9 mm | | 5 mm ... 9 mm | | 5 mm ... 9 mm | |
| Insertion/withdrawal cycles | ≥ 750 | | ≥ 750 | | ≥ 750 | | ≥ 750 | |
| Temperature data | | | | | | | | |
| Ambient temperature (operation) | -20°C ... 70°C | | -20°C ... 70°C | | -20°C ... 70°C | | -20°C ... 70°C | |
| | Ordering data | | | | Ordering data | | | |
| | Order No. | Pcs. / Pkt. | Order No. | Pcs. / Pkt. | Order No. | Pcs. / Pkt. | Order No. | Pcs. / Pkt. |
| Description | Ethernet printing | | PROFINET printing | | Ethernet printing | | PROFINET printing | |
| | | | | | | | | |
| RJ45 industrial connector, 8-pos. | 1406333 | 1 | 1406334 | 1 | 1406336 | 1 | 1406337 | 1 |
| Value pack | 1406351 | 30 | 1406352 | 30 | 1406354 | 30 | 1406355 | 30 |
| | Accessories | | | | Accessories | | | |
| | VS-CABLE-STRIP-VARIO | | 1657407 | 1 | VS-CABLE-STRIP-VARIO | | 1657407 | 1 |
| Stripping tool, for multiple-stage repositioning of shielded conductors | MICROFOX-SP-1 | | 1212487 | 1 | MICROFOX-SP-1 | | 1212487 | 1 |
| Electronic diagonal cutter, tapered head, without chamfer, with opening spring, non-reflective phosphate-treated surface, punched version | TMT 5 R | 0816430 | 1 | TMT 5 R | 0816430 | 1 | | |
| Markers for terminal blocks, roll, unmarked, can be marked with: THERMOMARK ROLL, THERMOMARK X, THERMOMARK S1.1 | TMT 5 R RD | 0816427 | 1 | TMT 5 R RD | 0816427 | 1 | | |
| | TMT 5 R GN | 0816401 | 1 | TMT 5 R GN | 0816401 | 1 | | |
| White | | | | | | | | |
| Red | | | | | | | | |
| Green | | | | | | | | |
| Marker for terminal blocks, sheet, white, unmarked, can be marked with: BLUEMARK CLED, BLUEMARK LED, plotter | UC-TMF 5 | | 0818153 | 10 | UC-TMF 5 | | 0818153 | 10 |

RJ45 industrial connectors, IP20



RJ45 industrial, cable outlet at the bottom

| | Technical data | | | |
|---|----------------------|-------------|-------------------|-------------|
| | Ethernet printing | | PROFINET printing | |
| Degree of protection | IP20 | | IP20 | |
| Connection cross section AWG | 26 ... 24 | | 23 ... 22 | |
| Transmission speed | 10 Gbps | | 1 Gbps | |
| Housing material | Zinc die-cast | | Zinc die-cast | |
| External cable diameter | 5 mm ... 9 mm | | 5 mm ... 9 mm | |
| Insertion/withdrawal cycles | ≥ 750 | | ≥ 750 | |
| Temperature data | | | | |
| Ambient temperature (operation) | -20°C ... 70°C | | -20°C ... 70°C | |
| Ordering data | | | | |
| Description | Order No. | Pcs. / Pkt. | Order No. | Pcs. / Pkt. |
| | Ethernet printing | | PROFINET printing | |
| RJ45 industrial connector, 8-pos. | 1406339 | 1 | 1406340 | 1 |
| Value pack | 1406357 | 30 | 1406358 | 30 |
| Accessories | | | | |
| Stripping tool, for multiple-stage repositioning of shielded conductors | VS-CABLE-STRIP-VARIO | | 1657407 | 1 |
| Electronic diagonal cutter, tapered head, without chamfer, with opening spring, non-reflective phosphate-treated surface, punched version | MICROFOX-SP-1 | | 1212487 | 1 |
| Markers for terminal blocks, roll, unmarked, can be marked with: THERMOMARK ROLL, THERMOMARK X, THERMOMARK S1.1 | TMT 5 R | | 0816430 | 1 |
| White | TMT 5 R RD | | 0816427 | 1 |
| Red | TMT 5 R GN | | 0816401 | 1 |
| Green | | | | |
| Marker for terminal blocks, sheet, white, unmarked, can be marked with: BLUEMARK CLED, BLUEMARK LED, plotter | UC-TMF 5 | | 0818153 | 10 |

Connection technology for field devices

Data connectors – RJ45 connectors

Push-pull industrial connectors, version 14

- High resistance to ESD and EMI for reliable transmission
- Easy handling, thanks to one-piece design
- Locking system to prevent unintentional removal
- Consistent 360° shielding concept



Push-pull Advance, straight cable outlet



Push-pull Advance, cable outlet at the top

| | Technical data | | Technical data | | | |
|---|----------------------|-------------------|-------------------|----------------------|---------|---|
| | Ethernet printing | PROFINET printing | Ethernet printing | PROFINET printing | | |
| Degree of protection | IP65/67 | IP65/67 | IP65/67 | IP65/67 | | |
| Connection cross section AWG | 26 ... 24 | 23 ... 22 | 26 ... 24 | 23 ... 22 | | |
| Transmission speed | 10 Gbps | 1 Gbps | 10 Gbps | 1 Gbps | | |
| Housing material | Zinc die-cast | Zinc die-cast | Zinc die-cast | Zinc die-cast | | |
| External cable diameter | 5.5 mm ... 10 mm | 5.5 mm ... 10 mm | 5.5 mm ... 10 mm | 5.5 mm ... 10 mm | | |
| Insertion/withdrawal cycles | ≥ 750 | ≥ 750 | ≥ 750 | ≥ 750 | | |
| Temperature data | | | | | | |
| Ambient temperature (operation) | -40°C ... 70°C | -40°C ... 70°C | -40°C ... 70°C | -40°C ... 70°C | | |
| | Ordering data | | | | | |
| | Order No. | Pcs. / Pkt. | Order No. | Pcs. / Pkt. | | |
| Description | Ethernet printing | | PROFINET printing | | | |
| | | | | | | |
| Value pack | 1407890 | 1 | 1407889 | 1 | | |
| | 1467901 | 10 | 1408039 | 10 | | |
| Description | Ethernet printing | | PROFINET printing | | | |
| | | | | | | |
| Value pack | 1468007 | 1 | 1408027 | 1 | | |
| | 1467807 | 10 | 1408092 | 10 | | |
| | Accessories | | Accessories | | | |
| | VS-CABLE-STRIP-VARIO | 1657407 | 1 | VS-CABLE-STRIP-VARIO | 1657407 | 1 |
| Stripping tool, for multiple-stage repositioning of shielded conductors | | | | | | |
| Electronic diagonal cutter, tapered head, without chamfer, with opening spring, non-reflective phosphate-treated surface, punched version | MICROFOX-SP-1 | 1212487 | 1 | MICROFOX-SP-1 | 1212487 | 1 |

**Push-pull industrial connectors,
version 14**



**Push-pull Advance,
cable outlet at the bottom**

| | |
|---------------------------------|--|
| Degree of protection | |
| Connection cross section AWG | |
| Transmission speed | |
| Housing material | |
| External cable diameter | |
| Insertion/withdrawal cycles | |
| Temperature data | |
| Ambient temperature (operation) | |

| Technical data | | |
|---------------------------------|-------------------|-------------------|
| | Ethernet printing | PROFINET printing |
| Degree of protection | IP65/67 | IP65/67 |
| Connection cross section AWG | 26 ... 24 | 23 ... 22 |
| Transmission speed | 10 Gbps | 1 Gbps |
| Housing material | Zinc die-cast | Zinc die-cast |
| External cable diameter | 5.5 mm ... 10 mm | 5.5 mm ... 10 mm |
| Insertion/withdrawal cycles | ≥ 750 | ≥ 750 |
| Ambient temperature (operation) | -40°C ... 70°C | -40°C ... 70°C |

| | |
|-------------|--|
| Description | |
| Value pack | |

| Ordering data | | | |
|-------------------|-------------|-------------------|-------------|
| Order No. | Pcs. / Pkt. | Order No. | Pcs. / Pkt. |
| Ethernet printing | | PROFINET printing | |
| 1408011 | 1 | 1407895 | 1 |
| 1467804 | 10 | 1408046 | 10 |

| | |
|---|--|
| Stripping tool, for multiple-stage repositioning of shielded conductors | |
| Electronic diagonal cutter, tapered head, without chamfer, with opening spring, non-reflective phosphate-treated surface, punched version | |

| Accessories | | |
|----------------------|-----------|-------------|
| Accessories | Order No. | Pcs. / Pkt. |
| VS-CABLE-STRIP-VARIO | 1657407 | 1 |
| MICROFOX-SP-1 | 1212487 | 1 |

Connection technology for field devices

Data connectors – fiber optic connectors

Push-pull industrial connectors, version 14

- Available for POF, PCF, and GOF
- Easy handling, thanks to one-piece design
- Locking system to prevent unintentional removal



Push-pull Advance, straight cable outlet



Push-pull Advance, cable outlet at the top

| | Technical data | | | Technical data | | |
|---|--------------------------------|--------------------------------|--------------------------------|--------------------------------|--------------------------------|------------------------------|
| | POF (Polymer Optical Fiber) | PCF (Polymer Cladded Fiber) | GOF (Glass Optical Fiber) | POF (Polymer Optical Fiber) | PCF (Polymer Cladded Fiber) | GOF (Glass Optical Fiber) |
| Degree of protection | IP65/67 | IP65/67 | IP65/67 | IP65/67 | IP65/67 | IP65/67 |
| Housing material | Zinc die-cast | Zinc die-cast | Zinc die-cast | Zinc die-cast | Zinc die-cast | Zinc die-cast |
| External cable diameter | 5.5 mm ... 10 mm | 5.5 mm ... 10 mm | 5.5 mm ... 10 mm | 5.5 mm ... 10 mm | 5.5 mm ... 10 mm | 5.5 mm ... 10 mm |
| Insertion/withdrawal cycles | ≥ 750 | ≥ 750 | ≥ 750 | ≥ 750 | ≥ 750 | ≥ 750 |
| Temperature data | | | | | | |
| Ambient temperature (operation) | -40°C ... 70°C | -40°C ... 70°C | -40°C ... 70°C | -40°C ... 70°C | -40°C ... 70°C | -40°C ... 70°C |
| Description | Ordering data | | | Ordering data | | |
| | Order No. | Pcs. / Pkt. | Order No. | Pcs. / Pkt. | Order No. | Pcs. / Pkt. |
| Push-pull Advance, SC-RJ connector | POF (Polymer Optical Fiber) | | PCF (Polymer Cladded Fiber) | | GOF (Glass Optical Fiber) | |
| | 1407896 | 1 | 1407897 | 1 | 1407898 | 1 |
| Value pack | 1408047 | 10 | 1408048 | 10 | 1408049 | 10 |
| | 1408028 | 1 | 1408029 | 1 | 1408030 | 1 |
| | 1408093 | 10 | 1408094 | 10 | 1408095 | 10 |
| SC-RJ cutting tool set, for polymer fiber (POF), for field assembly of connectors | Accessories | | | Accessories | | |
| | TF-SCRJ-POF KONF SET | | 1405246 | | TF-SCRJ-POF KONF SET | |
| Tool set for PCF Tool set for GOF | On request | | | On request | | |
| | On request | | | On request | | |

**Push-pull industrial connectors,
version 14**



**Push-pull Advance,
cable outlet at the bottom**

Technical data

| | POF (Polymer Optical Fiber) | PCF (Polymer Cladded Fiber) | GOF (Glass Optical Fiber) |
|---------------------------------|-----------------------------------|-----------------------------------|------------------------------|
| Degree of protection | IP65/67 | IP65/67 | IP65/67 |
| Housing material | Zinc die-cast | Zinc die-cast | Zinc die-cast |
| External cable diameter | 5.5 mm ... 10 mm | 5.5 mm ... 10 mm | 5.5 mm ... 10 mm |
| Insertion/withdrawal cycles | ≥ 750 | ≥ 750 | ≥ 750 |
| Temperature data | | | |
| Ambient temperature (operation) | -40°C ... 70°C | -40°C ... 70°C | -40°C ... 70°C |

Ordering data

| Description | Order No. | Pcs. / Pkt. | Order No. | Pcs. / Pkt. | Order No. | Pcs. / Pkt. |
|---|-----------------------------------|----------------|-----------------------------------|----------------|------------------------------|----------------|
| | POF (Polymer Optical Fiber) | | PCF (Polymer Cladded Fiber) | | GOF (Glass Optical Fiber) | |
| Push-pull Advance, SC-RJ connector | 1407902 | 1 | 1407904 | 1 | 1407905 | 1 |
| Value pack | 1408053 | 10 | 1408055 | 10 | 1408056 | 10 |

Accessories

| Description | Order No. | Pcs. / Pkt. |
|--|----------------------|----------------|
| SC-RJ cutting tool set, for polymer fiber (POF), for field assembly of connectors | TF-SCRJ-POF KONF SET | 1405246 |
| Tool set for PCF | On request | |
| Tool set for GOF | On request | |

Connection technology for field devices

Data connector – patch panel, terminal outlet

Modular distribution panel

- 19" distribution field with space for 8 modules, with a total of 48 x RJ45
- Front release without special tool
- Plug and Play – thanks to pre-assembled modules
- Up to 10 Gbps (Class E_A)
- Cable length according to customer requirements
- Optimized strain relief for every module
- GHMT certification



Assembled modules for 19" mounting frames



19" mounting frame

| | Technical data | | | Technical data | | |
|--|---------------------------------------|----------------|-------------|---------------------------|----------------|-------------|
| Electrical data | | | | | | |
| Transmission speed | 10 Gbps | | | - | | |
| Transmission characteristics (category) | Class E _A | | | - | | |
| Material data | | | | | | |
| Housing material | High-grade steel | | | Steel, powder-coated | | |
| Inflammability class according to UL 94 | V0 | | | V0 | | |
| Connection data | | | | | | |
| External cable diameter | 18 mm | | | - | | |
| Insertion/withdrawal cycles | ≥ 750 | | | - | | |
| Temperature data | | | | | | |
| Ambient temperature (operation) | -20°C ... 60°C | | | -20°C ... 60°C | | |
| | Ordering data | | | Ordering data | | |
| Description | Type | Order No. | Pcs. / Pkt. | Type | Order No. | Pcs. / Pkt. |
| 19" frame, empty, for using 8 modules (RJ45) | | | | | | |
| Gray (similar to RAL 7035) Black (similar to RAL 9005) | | | | CUC-PP-FRAME-19 | 1407986 | 1 |
| Module, RJ45 to RJ45 , consisting of two housings each with 6 x RJ45 10 Gbps (Class E _A) pre-assembled with multi-cable, variable length, GHMT-certified. | | | | CUC-PP-FRAME-19 BK | 1409140 | 1 |
| Patch bay, 19" , for orderly cabling in the control cabinet | CUC-PP-MODUL-RJ45:6-RJ45:6/... | 1407995 | 1 | | | |
| Gray, with plastic hooks Gray, with metal hooks Black, with metal hooks | | | | CUC-PP-PATCHBAY | 1407994 | 1 |
| Dummy frame, size of one module, for use in the frame | | | | CUC-PP-PATCHBAY-MH | 1409283 | 1 |
| | CUC-PP-PATCHBAY-MH BK | 1409284 | 1 | | | |
| | CUC-PP-MODUL-COVER | 1407988 | 1 | | | |

Ordering example for modules of variable length:

For an RJ45 module with a cable length of 25.0 m, the ordering data is as follows:

| | |
|-----------|--------------------------------------|
| Order No. | Length [m] |
| 1407995 | 25 |
| | Max. 80 m |
| | Increment: 1.5 m ... 80 m = 0.5 m |

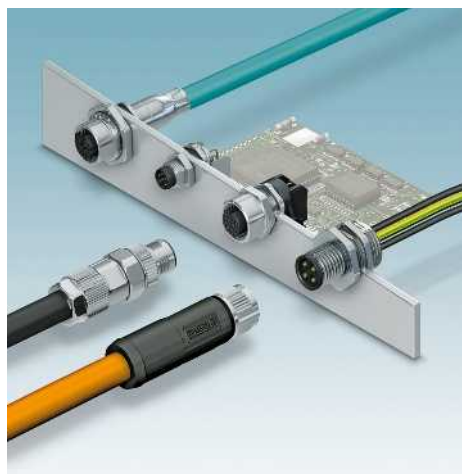
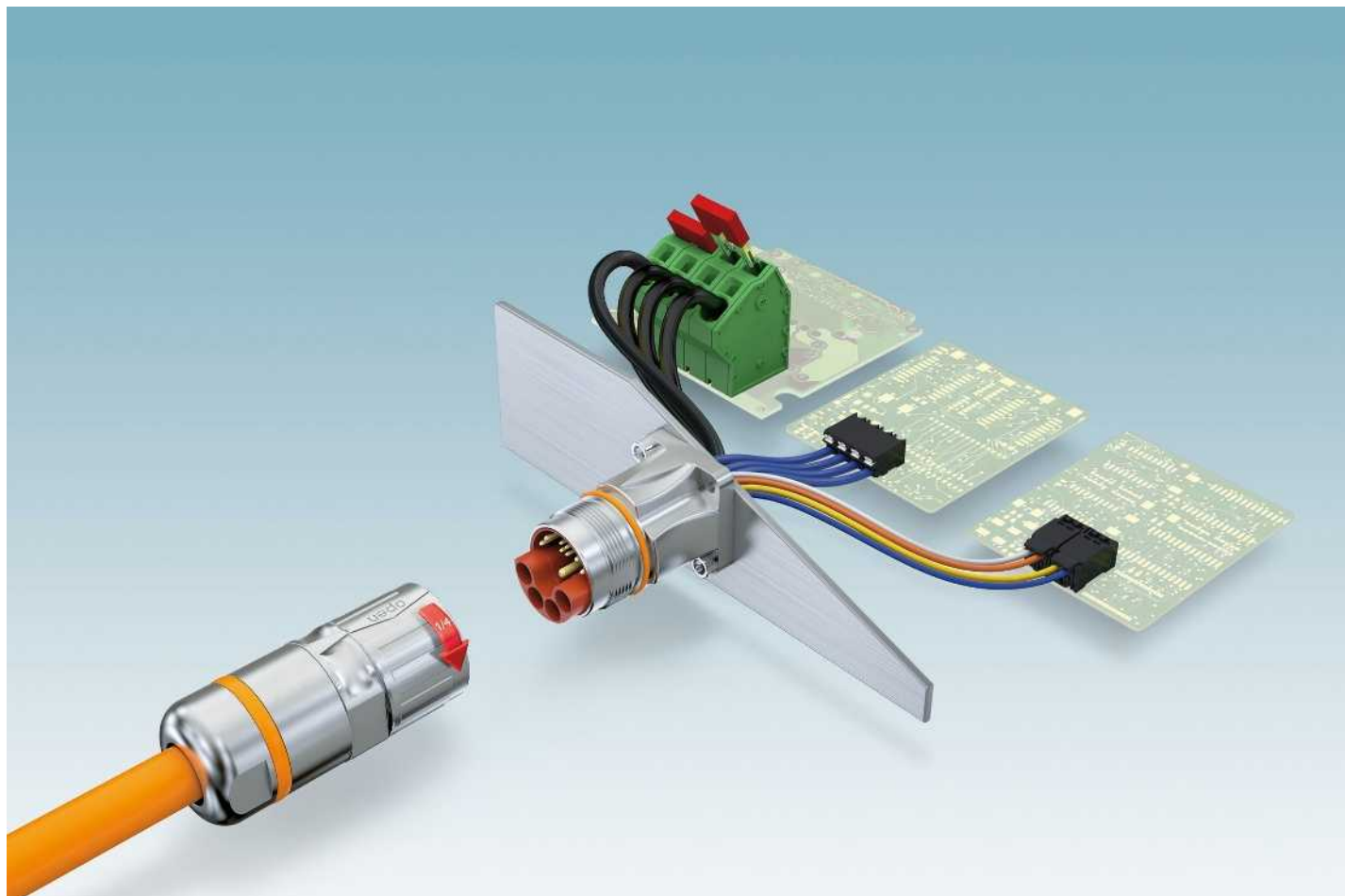

M5 to M12 circular connectors

Circular connectors for signals, data, and power.



M17 to M58 circular connectors

Circular connectors for signals, data, and power.



M12 rear mounting XL

The new device connectors for rear mounting feature an optimized housing contour with additional tightening limitation. This simplifies the housing cutout on the device and protects the O-ring during mounting.



M12 front mounting XL

The wrench flat on the new device connectors for front mounting has been enlarged and now features additional tightening limitation. This simplifies the device cutout and increases security and tightness when mounting.



M12 power front/rear mounting XL

The M12 XL housing design has also been introduced for the M12 power device connectors with S- and T-coding. This addition means that there is now a consistent design available for the M12 device connectors for signal and power.



M12 power for 230 V/16 A

The M12 power series has been extended with the 2+PE (S-coded) pin assignment. The M12 design means that a compact mains voltage plug is now available for 230 V and up to 16 A.



M23 hybrid cable and coupler connector

Special hybrid lines allow signals, data, and power to be transmitted using just one connector.



M23 hybrid device connectors

Angled, rotatable, and straight housing versions are available for front mounting on the device side.

Connection technology for field devices

M5 to M12 circular connectors

M12 device connectors XL, rear mounting

- M16 fastening thread
- With 0.5 m long litz wires
- Tightening limitation
- Wrench size 19



4-, 5-, 8-pos.



12-, 17-pos.

| | Technical data | | | Technical data | | | | | | | |
|---|------------------|------------------|------------------|------------------|------------------|-----------|-------------|-----------|-------------|-----------|-------------|
| | 4-pos. | 5-pos. | 8-pos. | 12-pos. | 17-pos. | | | | | | |
| General data | | | | | | | | | | | |
| M12 circular connector according to: | IEC 61076-2-101 | IEC 61076-2-101 | IEC 61076-2-101 | IEC 61076-2-101 | IEC 61076-2-101 | - | | | | | |
| Pollution degree | 3 | 3 | 3 | 3 | 3 | - | | | | | |
| Degree of protection | IP67 | IP67 | IP67 | IP67 | IP67 | - | | | | | |
| Connection method | Individual wires | Individual wires | Individual wires | Individual wires | Individual wires | - | | | | | |
| Electrical data | | | | | | | | | | | |
| Rated voltage | 250 V | 60 V | 30 V | 30 V | 30 V | - | | | | | |
| Rated current | 4 A | 4 A | 2 A | 1.5 A | 1.5 A | - | | | | | |
| Contact resistance | ≤ 3 mΩ | ≤ 3 mΩ | ≤ 3 mΩ | ≤ 3 mΩ | ≤ 3 mΩ | - | | | | | |
| Material data | | | | | | | | | | | |
| Material contact/contact surface | CuZn/Au | CuZn/Au | CuZn/Au | CuZn/Au | CuZn/Au | -/- | | | | | |
| Contact carrier material | PA 66 | PA 66 | PA 66 | PA 66 | PA 66 | - | | | | | |
| Inflammability class according to UL 94 | V0 | V0 | V0 | V0 | V0 | - | | | | | |
| Cable type | TPE litz wire | TPE litz wire | TPE litz wire | TPE litz wire | TPE litz wire | - | | | | | |
| Temperature data | | | | | | | | | | | |
| Plug/socket | -25 ... 85 | -25 ... 85 | -25 ... 85 | -25 ... 85 | -25 ... 85 | - | | | | | |
| | Ordering data | | | Ordering data | | | | | | | |
| Description | Coding | Order No. | Pcs. / Pkt. | Order No. | Pcs. / Pkt. | Order No. | Pcs. / Pkt. | Order No. | Pcs. / Pkt. | Order No. | Pcs. / Pkt. |
| | | 4-pos. | 5-pos. | 8-pos. | 12-pos. | 17-pos. | | | | | |
| Device connectors | | | | | | | | | | | |
| Socket | A - standard | 1411584 | 1 | 1411586 | 1 | 1411588 | 1 | 1411589 | 1 | 1411590 | 1 |
| Plug | A - standard | 1411591 | 1 | 1411593 | 1 | 1411595 | 1 | 1411596 | 1 | 1411597 | 1 |
| Socket | D - data | 1411585 | 1 | | | | | | | | |
| Plug | D - data | 1411592 | 1 | | | | | | | | |
| Socket | B - inverse | | | 1411587 | 1 | | | | | | |
| Plug | B - inverse | | | 1411594 | 1 | | | | | | |

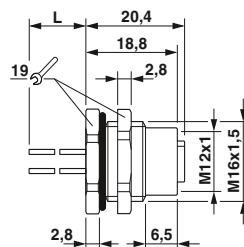

Dimensions: socket

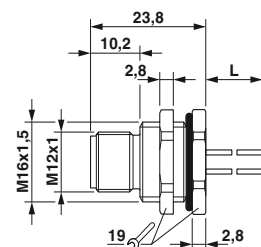

Dimensions: plug

M12 device connectors XL, front mounting

- M16 fastening thread
- With 0.5 m long litz wires
- Tightening limitation
- Wrench size 19



4-, 5-, 8-pos.



12-, 17-pos.

| | Technical data | | | Technical data | | | | | | | |
|---|------------------|------------------|------------------|------------------|------------------|-----------|-------------|-----------|-------------|-----------|-------------|
| | 4-pos. | 5-pos. | 8-pos. | 12-pos. | 17-pos. | | | | | | |
| General data | | | | | | | | | | | |
| M12 circular connector according to: | IEC 61076-2-101 | IEC 61076-2-101 | IEC 61076-2-101 | IEC 61076-2-101 | IEC 61076-2-101 | - | | | | | |
| Pollution degree | 3 | 3 | 3 | 3 | 3 | - | | | | | |
| Degree of protection | IP67 | IP67 | IP67 | IP67 | IP67 | - | | | | | |
| Connection method | Individual wires | Individual wires | Individual wires | Individual wires | Individual wires | - | | | | | |
| Electrical data | | | | | | | | | | | |
| Rated voltage | 250 V | 60 V | 30 V | 30 V | 30 V | - | | | | | |
| Rated current | 4 A | 4 A | 2 A | 1.5 A | 1.5 A | - | | | | | |
| Contact resistance | ≤ 3 mΩ | ≤ 3 mΩ | ≤ 3 mΩ | ≤ 3 mΩ | ≤ 3 mΩ | - | | | | | |
| Material data | | | | | | | | | | | |
| Material contact/contact surface | CuZn/Au | CuZn/Au | CuZn/Au | CuZn/Au | CuZn/Au | -/- | | | | | |
| Contact carrier material | PA 66 | PA 66 | PA 66 | PA 66 | PA 66 | - | | | | | |
| Inflammability class according to UL 94 | V0 | V0 | V0 | V0 | V0 | - | | | | | |
| Cable type | TPE litz wire | TPE litz wire | TPE litz wire | TPE litz wire | TPE litz wire | - | | | | | |
| Temperature data | | | | | | | | | | | |
| Plug/socket | -25 ... 85 | -25 ... 85 | -25 ... 85 | -25 ... 85 | -25 ... 85 | - | | | | | |
| | Ordering data | | | Ordering data | | | | | | | |
| Description | Coding | Order No. | Pcs. / Pkt. | Order No. | Pcs. / Pkt. | Order No. | Pcs. / Pkt. | Order No. | Pcs. / Pkt. | Order No. | Pcs. / Pkt. |
| | | 4-pos. | 5-pos. | 8-pos. | 12-pos. | 17-pos. | | | | | |
| Device connectors | | | | | | | | | | | |
| Socket | A - standard | 1411568 | 1 | 1411571 | 1 | 1411573 | 1 | 1411574 | 1 | 1411576 | 1 |
| Plug | A - standard | 1411577 | 1 | 1411579 | 1 | 1411581 | 1 | 1411582 | 1 | 1411583 | 1 |
| Socket | D - data | 1411569 | 1 | | | | | | | | |
| Plug | D - data | 1411578 | 1 | | | | | | | | |
| Socket | B - inverse | | | 1411572 | 1 | | | | | | |
| Plug | B - inverse | | | 1411580 | 1 | | | | | | |

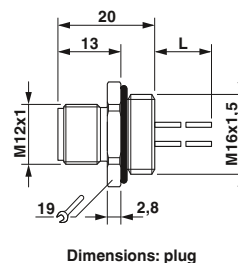
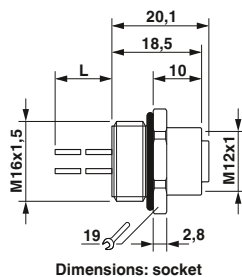

Connection technology for field devices

M5 to M12 circular connectors

M12 power device connectors XL, rear mounting

- M16 fastening thread
- With 0.5 m long litz wires
- Tightening limitation
- Wrench size 19



S-coded, 3-pos. + PE



T-coded, 4-pos.

| | Technical data | Technical data |
|---|---------------------------------------|-------------------------------------|
| General data | | |
| Pollution degree | 3 | 3 |
| Degree of protection | IP67 | IP67 |
| Connection method | Individual wires | Individual wires |
| Electrical data | | |
| Rated voltage | 630 V | 60 V |
| Rated current | 12 A | 12 A |
| Contact resistance | ≤ 3 mΩ | ≤ 3 mΩ |
| Material data | | |
| Material contact/contact surface | CuZn/Au | CuZn/Au |
| Contact carrier material | PA | PA |
| Inflammability class according to UL 94 | V0 | V0 |
| Cable type | PP litz wire | PP litz wire |
| Temperature data | | |
| Plug/socket | -25 ... 85 [°C] | -25 ... 85 |
| | Ordering data | Ordering data |
| Description | | |
| Power device connectors | | |
| Socket | SACC-DSI-M12FSS-4P-M16XL/0,5PE | SACC-DSI-M12FST-4P-M16XL/0,5 |
| Plug | SACC-DSI-M12MSS-4P-M16XL/0,5PE | SACC-DSI-M12MST-4P-M16XL/0,5 |
| | Order No. | Order No. |
| | 1411598 | 1411599 |
| | 1411603 | 1411604 |
| | Pcs. / Pkt. | Pcs. / Pkt. |
| | 1 | 1 |
| | 1 | 1 |

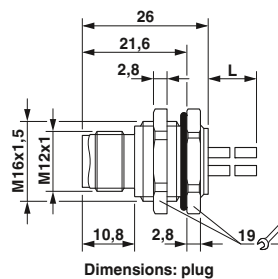
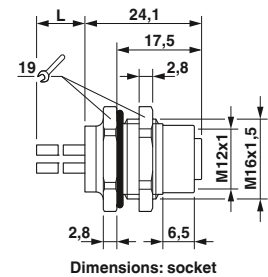
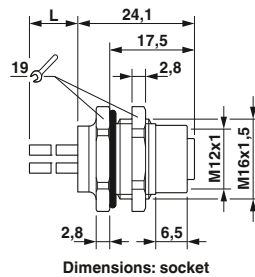

M12 power device connectors XL, front mounting

- M16 fastening thread
- With 0.5 m long litz wires
- Tightening limitation
- Wrench size 19



S-coded, 3-pos. + PE



T-coded, 4-pos.

| | Technical data | Technical data | | | | |
|---|-------------------------------|------------------|-------------|----------------------------|-----------|-------------|
| General data | | | | | | |
| Pollution degree | 3 | 3 | | | | |
| Degree of protection | IP67 | IP67 | | | | |
| Connection method | Individual wires | Individual wires | | | | |
| Electrical data | | | | | | |
| Rated voltage | 630 V | 60 V | | | | |
| Rated current | 12 A | 12 A | | | | |
| Contact resistance | ≤ 3 mΩ | ≤ 3 mΩ | | | | |
| Material data | | | | | | |
| Material contact/contact surface | CuZn/Au | CuZn/Au | | | | |
| Contact carrier material | PA | PA | | | | |
| Inflammability class according to UL 94 | V0 | V0 | | | | |
| Cable type | PP litz wire | PP litz wire | | | | |
| Temperature data | | | | | | |
| Plug/socket | -25 ... 85 [°C] | -25 ... 85 | | | | |
| | Ordering data | Ordering data | | | | |
| Description | Type | Order No. | Pcs. / Pkt. | Type | Order No. | Pcs. / Pkt. |
| Power device connectors | | | | | | |
| Socket | SACC-E-M12FSS-4P-M16XL/0,5 PE | 1411605 | 1 | SACC-E-M12FST-4P-M16XL/0,5 | 1411606 | 1 |
| Plug | SACC-E-M12MSS-4P-M16XL/0,5 PE | 1411607 | 1 | SACC-E-M12MST-4P-M16XL/0,5 | 1411608 | 1 |

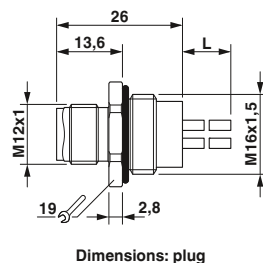
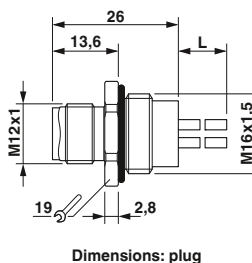
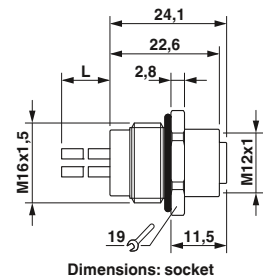
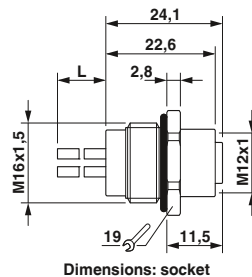

Connection technology for field devices

M5 to M12 circular connectors

M12 power device connectors, 2-pos. + PE

- M16 fastening thread
- With 0.5 m long litz wires
- S-coded



Rear mounting



Front mounting

| | | Technical data | | | Technical data | | |
|---|---------|-------------------------------|-----------|-------------|-----------------------------|-----------|-------------|
| General data | | | | | | | |
| Pollution degree | | 3 | | | 3 | | |
| Degree of protection | | IP67 | | | IP67 | | |
| Connection method | | Individual wires | | | Individual wires | | |
| Electrical data | | | | | | | |
| Rated voltage | | 630 V | | | 630 V | | |
| Rated current | | 16 A | | | 16 A | | |
| Contact resistance | | ≤ 3 mΩ | | | ≤ 3 mΩ | | |
| Material data | | | | | | | |
| Material contact/contact surface | | CuZn/Au | | | CuZn/Au | | |
| Contact carrier material | | PA | | | PA | | |
| Inflammability class according to UL 94 | | V0 | | | V0 | | |
| Cable type | | PP litz wire | | | PP litz wire | | |
| Temperature data | | | | | | | |
| Plug/socket | | [-25 ... 105 °C] | | | [-25 ... 105 °C] | | |
| | | Ordering data | | | Ordering data | | |
| Description | Coding | Type | Order No. | Pcs. / Pkt. | Type | Order No. | Pcs. / Pkt. |
| Power device connectors | | | | | | | |
| Socket | S power | SACC-DSI-M12FSS-3P-M16/0,5 PE | 1411652 | 1 | SACC-E-M12FSS-3P-M16/0,5 PE | 1411654 | 1 |
| Plug | S power | SACC-DSI-M12MSS-3P-M16/0,5 PE | 1411653 | 1 | SACC-E-M12MSS-3P-M16/0,5 PE | 1411655 | 1 |

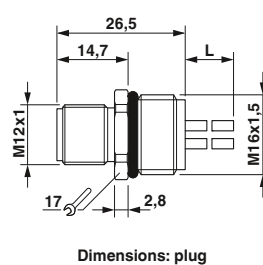
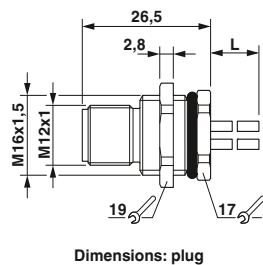
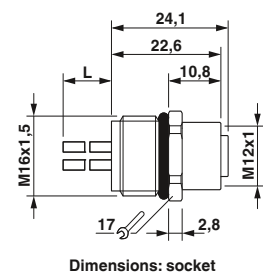
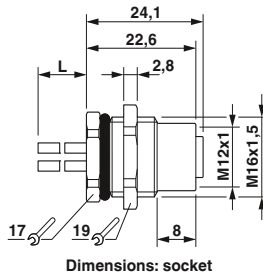

Mechanical and electrical data

Mechanical data

| | |
|------------------------------------|--|
| Housing material: | Copper zinc alloy (CuZn), die-cast zinc (GD-Zn) |
| Housing surface: | Nickel-plated/thick layer passivated (can be coated) |
| Insulating body: | Polyamide (PA 66) |
| Contact material: | Copper zinc alloy (CuZn) |
| Contact surface: | Nickel-plated (Ni) with gold coating (Au) |
| Contact connection method: | Crimp version |
| Sealing and O-ring: | Fluorocarbon rubber (FKM) |
| Ambient temperature: | -40°C ... 130°C |
| Cable entry: | Cable and coupler connectors for outer cable diameter of 7.5 - 18 mm, shielded |
| Type of locking: | M23 SPEEDCON screw locking |
| Mech. insertion/withdrawal cycles: | Standard: 100 |
| Protection class: | IP67 in the locked state |

Electrical data

| No. of positions | 13 (4+4+4+PE), CAT5 | | | | 13 (8+4+PE) | | | | | | | |
|--|---------------------|--------------|--------------|--------------|--------------|--------------|--------------|--------------|---|-----|---|-----|
| Contacts | 4 | + | 4 | + | 4 | + | PE | 8 | + | 4 | + | PE |
| Contact Ø [mm] | 0.8 | | 1.0 | | 2.0 | | 2.0 | 1.0 | | 2.0 | | 2.0 |
| Litz wire cross sections | | | | | | | | | | | | |
| Cable and coupler connectors: | | | | | | | | | | | | |
| Max. cable Ø of 18 mm | [mm ²] | 0.08 ... 0.5 | 0.06 ... 1.0 | 0.25 ... 4.0 | 0.25 ... 4.0 | 0.06 ... 1.0 | 0.25 ... 4.0 | 0.25 ... 4.0 | | | | |
| Device connector: | [mm ²] | 0.08 ... 0.5 | 0.06 ... 1.0 | 0.25 ... 4.0 | 0.25 ... 4.0 | 0.06 ... 1.0 | 0.25 ... 4.0 | 0.25 ... 4.0 | | | | |
| Nominal current per contact at 25°C ¹⁾ | | | | | | | | | | | | |
| | | 3.6 | 8 | 30 | - | 8 | 30 | - | | | | |
| Specifications according to DIN EN 61984:2009 | | | | | | | | | | | | |
| Rated voltage | [V AC/DC] | 50 | 50 | 630/850 | - | 50 | 630/850 | - | | | | |
| Test/surge voltage | [kV AC] | 1.5 | 1.5 | 6 | - | 1.5 | 6 | - | | | | |
| Surge voltage category | | | | | | | | | | | | |
| III | | | | | | | | | | | | |
| Pollution degree ²⁾ | | | | | | | | | | | | |
| 3 | | | | | | | | | | | | |
| Installation height | | | | | | | | | | | | |
| Up to 3000 | | | | | | | | | | | | |
| Cable clamping area ³⁾ Max. Ø [mm] | | | | | | | | | | | | |
| 18 | | | | | | | | | | | | |

¹⁾ The effective current carrying capacity must be determined using a derating curve, if necessary, according to the application.

²⁾ The values specified assume that the connector pair is correctly locked and is only disconnected for testing and maintenance purposes. If the connector is unlocked and exposed to ambient conditions, and if there is a danger of contamination, the connector must be sealed using a protective cap ≥ IP54.

³⁾ The cable clamping areas specified on the following pages may vary depending on the cable material/structure. Selection and testing is the responsibility of the user.

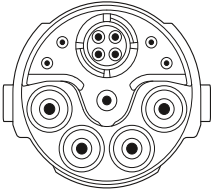
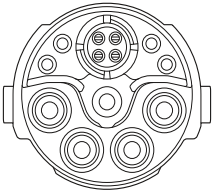
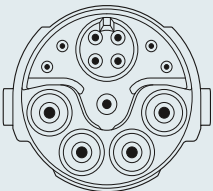
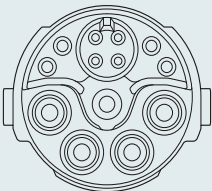
| Contact chamber numbering (view of plug-in side) | | | | |
|---|---|--|--|--|
| No. of positions | Pin | | Socket | |
| 13-pos., CAT5 (4 + 4 + 4 + PE) Crimp |  | |  | |
| 13-pos. (8 + 4 + PE) Crimp |  | |  | |

Connection technology for field devices

M17 to M58 circular connectors

M23 cable connector, hybrid, SPEEDCON fast locking system

- 4 x power + PE, 4 x signal, 4 x data
- 4 x power + PE, 8 x signal



Cable connector, socket assembly



Cable connector, pin assembly

| Description | | Ordering data | | Ordering data | | | | | |
|--|---------------------|--|-------------|--|-------------|--|-------------|------------|---|
| | | Order No. | Pcs. / Pkt. | Order No. | Pcs. / Pkt. | Order No. | Pcs. / Pkt. | | |
| | Cable clamping area | 4 x signal + CAT5 | | 8 x signal | | 4 x signal + CAT5 | | 8 x signal | |
| Cable connector , with contact carrier, without contacts, crimp connection | | | | | | | | | |
| Universal gasket | 7.5 mm ... 18 mm | 1621517 | 1 | 1621524 | 1 | 1621529 | 1 | 1621534 | 1 |
| | 7.5 mm ... 9 mm | 1621520 | 1 | 1621525 | 1 | 1621530 | 1 | 1621535 | 1 |
| | 9 mm ... 12 mm | 1621521 | 1 | 1621526 | 1 | 1621531 | 1 | 1621536 | 1 |
| | 12 mm ... 15 mm | 1621522 | 1 | 1621527 | 1 | 1621532 | 1 | 1621537 | 1 |
| | 15 mm ... 18 mm | 1621523 | 1 | 1621528 | 1 | 1621533 | 1 | 1621538 | 1 |
| Accessories | | Accessories | | Accessories | | | | | |
| | | Crimp contacts Color rings, 50 pcs. in set (to be ordered separately) | | See page 66 See Catalog 2, page 367 | | See page 66 See Catalog 2, page 367 | | | |

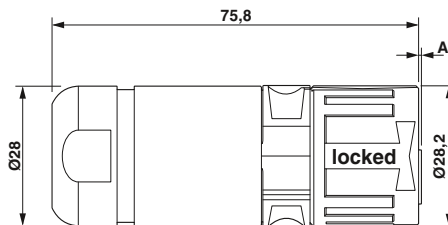

Pin version: dimension A = 0.2 mm,
socket version: dimension A = 0 mm

M23 coupler connector, hybrid

- 4 x power + PE, 4 x signal, 4 x data
- 4 x power + PE, 8 x signal



Coupler connector, socket assembly



Coupler connector, pin assembly

| | | Ordering data | | | | Ordering data | | | |
|--|---------------------|-------------------------|-------------|------------|-------------|-------------------------|-------------|------------|-------------|
| Description | Cable clamping area | Order No. | Pcs. / Pkt. | Order No. | Pcs. / Pkt. | Order No. | Pcs. / Pkt. | Order No. | Pcs. / Pkt. |
| | | 4 x signal + CAT5 | | 8 x signal | | 4 x signal + CAT5 | | 8 x signal | |
| Coupler connector, with contact carrier, without contacts, crimp connection | | | | | | | | | |
| Universal gasket | 7.5 mm ... 18 mm | 1621539 | 1 | 1621544 | 1 | 1621549 | 1 | 1621554 | 1 |
| | 7.5 mm ... 9 mm | 1621540 | 1 | 1621545 | 1 | 1621550 | 1 | 1621555 | 1 |
| | 9 mm ... 12 mm | 1621541 | 1 | 1621546 | 1 | 1621551 | 1 | 1621556 | 1 |
| | 12 mm ... 15 mm | 1621542 | 1 | 1621547 | 1 | 1621552 | 1 | 1621557 | 1 |
| | 15 mm ... 18 mm | 1621543 | 1 | 1621548 | 1 | 1621553 | 1 | 1621558 | 1 |
| | | Accessories | | | | Accessories | | | |
| Crimp contacts | | See page 66 | | | | See page 66 | | | |
| Color rings, 50 pcs. in set (to be ordered separately) | | See Catalog 2, page 367 | | | | See Catalog 2, page 367 | | | |

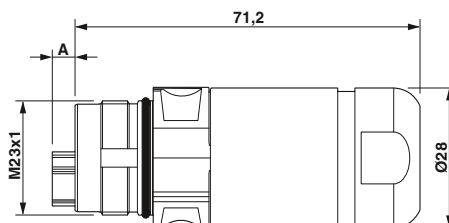

Pin version: dimension A = 4.7 mm,
socket version: dimension A = 0 mm

Connection technology for field devices

M17 to M58 circular connectors

M23 device connectors, hybrid, straight

- 4 x power + PE, 4 x signal, 4 x data
- 4 x power + PE, 8 x signal



Device connector, straight, socket assembly



Device connector, straight, pin assembly

| Description | Ordering data | | | | Ordering data | | | |
|--|--|-------------|-----------|-------------|--|-------------|-----------|-------------|
| | Order No. | Pcs. / Pkt. | Order No. | Pcs. / Pkt. | Order No. | Pcs. / Pkt. | Order No. | Pcs. / Pkt. |
| Device connector, with contact carrier, without contacts | 1621567 | 1 | 1621568 | 1 | 1621569 | 1 | 1621570 | 1 |
| Flange dimensions: 26 mm x 26 mm | | | | | | | | |
| Crimp contacts Color rings, 50 pcs. in set (to be ordered separately) | See page 66 See Catalog 2, page 367 | | | | See page 66 See Catalog 2, page 367 | | | |

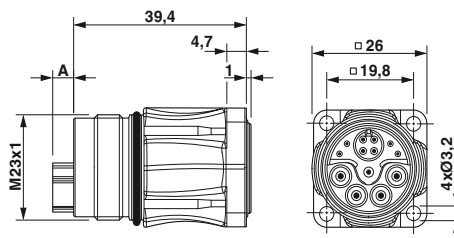

Pin version: dimension A = 4.75 mm,
socket version: dimension A = 0 mm

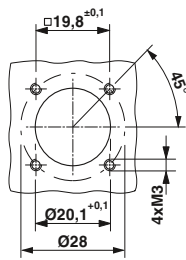

Installation dimensions

M23 device connector, hybrid, angled, rotatable

- 4 x power + PE, 4 x signal, 4 x data
- 4 x power + PE, 8 x signal
- Housing can be freely rotated by 310°



Device connector, angled, rotatable, socket assembly



Device connector, angled, rotatable, pin assembly

| Ordering data | | | |
|--|-------------|------------|-------------|
| Order No. | Pcs. / Pkt. | Order No. | Pcs. / Pkt. |
| 4 x signal + CAT5 | | 8 x signal | |
| 1621563 | 1 | 1621564 | 1 |
| 1621559 | 1 | 1621560 | 1 |
| Accessories | | | |
| See page 66 See Catalog 2, page 367 | | | |

| Ordering data | | | |
|--|-------------|------------|-------------|
| Order No. | Pcs. / Pkt. | Order No. | Pcs. / Pkt. |
| 4 x signal + CAT5 | | 8 x signal | |
| 1621565 | 1 | 1621566 | 1 |
| 1621561 | 1 | 1621562 | 1 |
| Accessories | | | |
| See page 66 See Catalog 2, page 367 | | | |

| |
|--|
| Description |
| Device connector, with contact carrier, without contacts |
| Flange dimensions: 26 mm x 26 mm |
| Device connector, with contact carrier, without contacts |
| Flange dimensions: 28 mm x 28 mm |
| Crimp contacts |
| Color rings, 50 pcs. in set (to be ordered separately) |

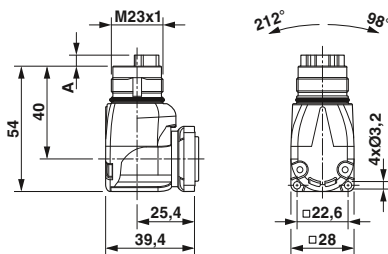

Pin version: dimension A = 4.7 mm, socket version: dimension A = 0 mm

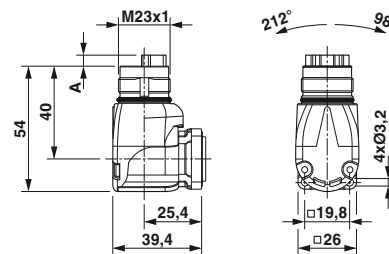

Pin version: dimension A = 4.7 mm, socket version: dimension A = 0 mm

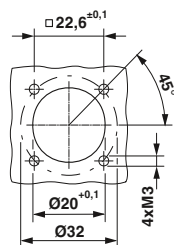

Installation dimensions

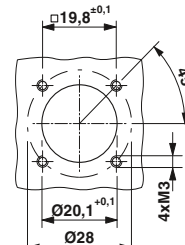

Installation dimensions

Crimp contacts



Crimp contacts,
socket



Crimp contacts,
pin

| Description | Connection cross section [mm ²] | Ordering data | | | Ordering data | | |
|---------------------------|---|---------------|-----------|-------------|---------------|-----------|-------------|
| | | Type | Order No. | Pcs. / Pkt. | Type | Order No. | Pcs. / Pkt. |
| Contacts, Ø 0.8 mm | 0.08 mm ² ... 0.25 mm ² | SF-08KS010 | 1621571 | 100 | SF-08KP010 | 1621574 | 100 |
| | 0.34 mm ² ... 0.5 mm ² | SF-08KS020 | 1621573 | 100 | SF-08KP020 | 1621575 | 100 |
| Contacts, Ø 1.0 mm | 0.06 mm ² ... 0.25 mm ² | ST-10KS010 | 1618239 | 100 | ST-10KP010 | 1618255 | 100 |
| | 0.34 mm ² ... 0.5 mm ² | ST-10KS020 | 1618251 | 100 | ST-10KP020 | 1618256 | 100 |
| | 0.5 mm ² ... 1.0 mm ² | ST-10KS030 | 1618254 | 100 | ST-10KP030 | 1618261 | 100 |
| Contacts, Ø 2.0 mm | 0.25 mm ² ... 1.0 mm ² | SF-20KS021 | 1621576 | 50 | SF-20KP021 | 1621579 | 50 |
| | 1.0 mm ² ... 2.5 mm ² | SF-20KS022 | 1621577 | 50 | SF-20KP022 | 1621580 | 50 |
| | 2.5 mm ² ... 4.0 mm ² | SF-20KS023 | 1621578 | 50 | SF-20KP023 | 1621581 | 50 |



Flexibility is required when it comes to the structure of a sustainable power supply system. A combination of various sources of renewable energy – even in conjunction with storage technologies – is already proving cost-effective. What is striking here is that miniaturization is more than just a trend; it is a recognized method of increasing system efficiency.

In photovoltaics, the micro inverter, the little brother of the string inverter, is particularly gaining in popularity. It can even be used cost-effectively in locations that are clearly less than ideal. Double-figure percentage increases in yield in comparison to string inverters mean that even areas that are not ideal can be used cost-effectively.

SUNCLIX micon, the connection system for the AC-side of micro inverters, simplifies installation using components which have proven themselves a million times over.



AC-Y connectors

The AC-Y connectors consist of two 3-pos. connections, which are connected to each other via the trunk line without the risk of polarity reversal. In addition to accommodating the trunk line, the coupling side also accommodates the drop line, which serves as a connection to the inverter.



Mains connector plugs

The mains connector plugs provide the connecting link between the PV system and mains. Depending on the system structure, the mains can be connected via the plug or coupling side of the AC Y-connector. The free cable end is either connected in a distributor box or fed into an incoming mains feeder box via a cable sleeve.



Protective caps

Dust protection caps (brown) made from biodegradable plastic protect the pin connector pattern from contamination during transport. When it comes to installation, they can be easily removed from the plug without any special tools. During installation, the IP protective caps (black) are inserted as an end cap on the last connector in order to protect it from atmospheric influences.



Contact removal tool

The locking mechanism on the connector is extremely robust and prevents unintentional release. The contact removal tool enables the lock to be opened easily and quickly. Thanks to an additional latch, it does not fall out of the plug housing once it has been released.



DC connectors

With the SUNCLIX DC connector as a device plug or for field assembly, you can also impress with performance and quality on the module side.

Connection technology for field devices

Photovoltaic AC connectors

SUNCLIX micon

- Pre-assembled sets for minimum effort at the installation site
- Customer-specific versions on request
- Networked cables
- Proven SUNCLIX contact technology for optimum system performance



AC Y-distributor



Mains connector plug for the coupling side

| | Technical data | | | Technical data | | |
|--|-------------------------------|------------------|----------------------|--------------------------------|---------------------|-------------|
| | North American version | European version | | North American version | European version | |
| General data | | | | | | |
| Degree of protection | IP67 | IP67 | | IP67 | IP67 | |
| Electrical data | | | | | | |
| Rated voltage | 600 V | 400 V | | 600 V | 400 V | |
| Rated current | | | | | | |
| | Trunk line | 20 A | 20 A | 20 A | 20 A | |
| | Drop line | 5 A | 5 A | - | - | |
| Conductor cross section | | | | | | |
| | Trunk line | 12 AWG | 2.5 mm ² | 12 AWG | 2.5 mm ² | |
| | Drop line | 14 AWG | 0.75 mm ² | - | - | |
| No. of pos. | | | | | | |
| | Trunk line | 3 | 3 | 3 | 3 | |
| | Drop line | 3 | 3 | - | - | |
| Cable length | | | | | | |
| | Trunk line | 1150 mm | 1150 mm | 1000 mm | 1000 mm | |
| | Drop line | 500 mm | 500 mm | - | - | |
| Temperature data | | | | | | |
| Ambient temperature (operation) | -40°C ... 90°C | -40°C ... 85°C | | -40°C ... 90°C | -40°C ... 85°C | |
| | Ordering data | | | Ordering data | | |
| Description | Type | Order No. | Pcs. / Pkt. | Type | Order No. | Pcs. / Pkt. |
| AC Y-distributor for PV microinverters incl. dust protection caps | | | | | | |
| North American version | PV-MI-YC-1,15-3-12-NA-0,50-OE | 1706518 | 1 | | | |
| European version | PV-MI-YC-1,15-3-25-EU-0,50-OE | 1621351 | 1 | | | |
| Mains connector plug of the AC Y-distributor incl. IP protective cap and contact removal tool | | | | | | |
| North American version | | | | PV-MI-YC-GC-P-1,00-3-12-NA SET | 1707091 | 1 |
| European version | | | | PV-MI-YC-GC-P-1,00-3-25-EU SET | 1621349 | 1 |
| Patch cable for extending the trunk line incl. dust protection caps | | | | | | |
| North American version | | | | | | |
| European version | | | | | | |
| | Accessories | | | Accessories | | |
| Dust protection cap, IP40 , for SUNCLIX micon | | | | | | |
| Coupling side | PV-MI-YC-CARRIER-CAP-TS | 1706599 | 5 | PV-MI-YC-CARRIER-CAP-TS | 1706599 | 5 |
| Plug side | PV-MI-YC-CARRIER-CAP-TP | 1706608 | 5 | PV-MI-YC-CARRIER-CAP-TP | 1706608 | 5 |
| Protective cap, IP67 , for SUNCLIX micon | | | | | | |
| Coupling side | PV-MI-YC-PROTECTION-CAP-TS | 1706515 | 1 | PV-MI-YC-PROTECTION-CAP-TS | 1706515 | 1 |
| Plug side | PV-MI-YC-PROTECTION-CAP-TP | 1706610 | 1 | PV-MI-YC-PROTECTION-CAP-TP | 1706610 | 1 |
| Contact removal tool , for SUNCLIX micon, trunk line | | | | | | |
| | PV-MI-YC-UNLOCKTOOL | 1706514 | 5 | PV-MI-YC-UNLOCKTOOL | 1706514 | 5 |



Mains connector plug
for the plug side



Patch cable

| Technical data | |
|------------------------|---------------------|
| North American version | European version |
| IP67 | IP67 |
| 600 V | 400 V |
| 20 A | 20 A |
| - | - |
| 12 AWG | 2.5 mm ² |
| - | - |
| 3 | 3 |
| - | - |
| 1000 mm | 1000 mm |
| - | - |
| -40°C ... 90°C | -40°C ... 85°C |

| Technical data | |
|------------------------|---------------------|
| North American version | European version |
| IP67 | IP67 |
| 600 V | 400 V |
| 20 A | 20 A |
| - | - |
| 12 AWG | 2.5 mm ² |
| - | - |
| 3 | 3 |
| - | - |
| 1000 mm | 1000 mm |
| - | - |
| -40°C ... 90°C | -40°C ... 85°C |

| Ordering data | | |
|--------------------------------|-----------|-------------|
| Type | Order No. | Pcs. / Pkt. |
| PV-MI-YC-GC-S-1,00-3-12-NA SET | 1707092 | 1 |
| PV-MI-YC-GC-S-1,00-3-25-EU SET | 1621350 | 1 |

| Ordering data | | |
|-----------------------------|-----------|-------------|
| Type | Order No. | Pcs. / Pkt. |
| PV-MI-YC-PATCH-1,00-3-12-NA | 1707090 | 10 |
| PV-MI-YC-PATCH-1,00-3-25-EU | 1621352 | 10 |

| Accessories | | |
|----------------------------|-----------|-------------|
| Type | Order No. | Pcs. / Pkt. |
| PV-MI-YC-CARRIER-CAP-TS | 1706599 | 5 |
| PV-MI-YC-CARRIER-CAP-TP | 1706608 | 5 |
| PV-MI-YC-PROTECTION-CAP-TS | 1706515 | 1 |
| PV-MI-YC-PROTECTION-CAP-TP | 1706610 | 1 |
| PV-MI-YC-UNLOCKTOOL | 1706514 | 5 |

| Accessories | | |
|----------------------------|-----------|-------------|
| Type | Order No. | Pcs. / Pkt. |
| PV-MI-YC-CARRIER-CAP-TS | 1706599 | 5 |
| PV-MI-YC-CARRIER-CAP-TP | 1706608 | 5 |
| PV-MI-YC-PROTECTION-CAP-TS | 1706515 | 1 |
| PV-MI-YC-PROTECTION-CAP-TP | 1706610 | 1 |
| PV-MI-YC-UNLOCKTOOL | 1706514 | 5 |

Photovoltaic AC connectors

Cable installation

Cable splice kit

- Cable-to-cable connection
- IP67 for outdoor applications
- Accepts three conductors, 1.5 mm² to 25 mm² (16 to 4 AWG)

Cable terminator

- End-of-run cable terminator
- IP67 for outdoor applications
- Accepts three conductors, 1.5 mm² to 25 mm² (16 to 4 AWG)



Cable splice kit



Cable terminator

| | Technical data | | | Technical data | | |
|--|--|----------------|-------------|--|----------------|-------------|
| General data | | | | | | |
| Degree of protection | IP67 | | | IP67 | | |
| Connection method | Screw connection within housing | | | - | | |
| Electrical data | | | | | | |
| Rated voltage | 600 V AC/DC | | | 600 V AC/DC | | |
| Rated current | 30 A | | | - | | |
| Conductor cross section [mm ² // AWG] | 1.5 mm ² ... 25 mm ² // 16 ... 4 | | | 1.5 mm ² ... 25 mm ² // 16 ... 4 | | |
| Cable diameter | 9.5 mm ... 13 mm (0.37 ... 0.51 in.) | | | 9.5 mm ... 13 mm (0.37 ... 0.51 in.) | | |
| Temperature data | | | | | | |
| Ambient temperature (operation) | -40°C ... 90°C | | | -40°C ... 90°C | | |
| | Ordering data | | | Ordering data | | |
| Description | Type | Order No. | Pcs. / Pkt. | Type | Order No. | Pcs. / Pkt. |
| Cable splice kit - 3 conductors | PV-MI-CABLE SPLICE 3P | 1812403 | 1 | | | |
| Cable terminator - 3 conductors | | | | PV-MI-CABLE TERMINATOR 3P | 1812416 | 1 |

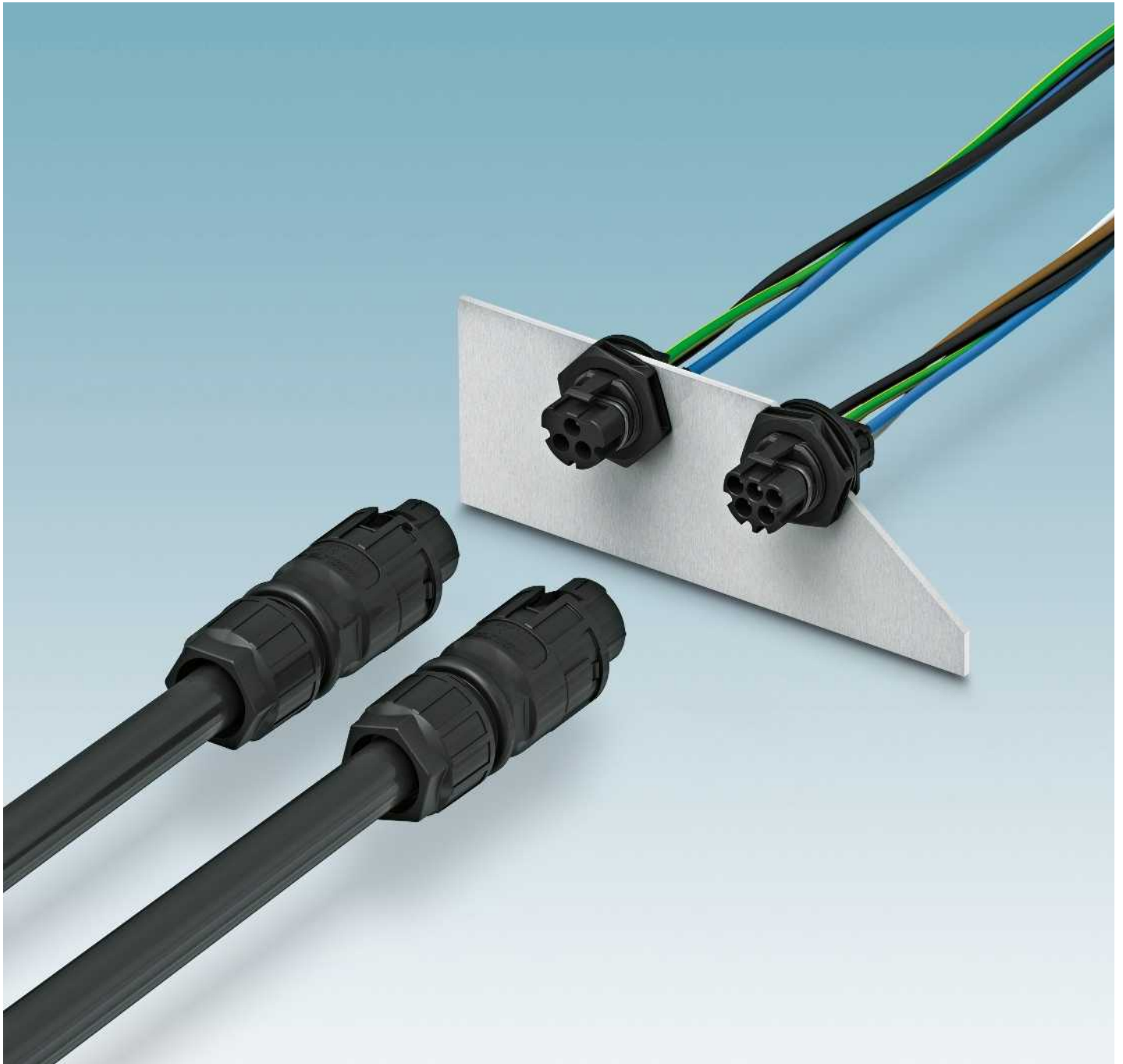

IP-protected circular connectors for power electronics

The new power connectors in the PRC series enable you to reliably and conveniently connect 3 and 5-wire cables to your device (e.g., a solar inverter). The device connectors with crimp connection are supplied pre-assembled with punched-on litz wires or alternatively they can be self-assembled.



Remove the cable sheath, strip the wires, and conveniently connect with screw connection



Snap the contact carrier into the plug housing



Tighten the cable gland



– Sealable for protection against tampering



– UV-resistant plastic for safe outdoor use

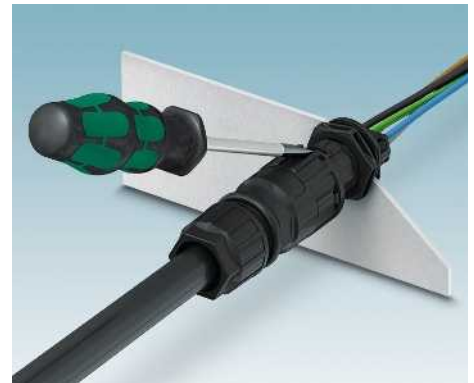

– Secure latching to be disconnected using tool



– Fully flexible for the device manufacturer: Pre-assembled panel feed-through or flexible and rapid self-assembly.



– The mechanical coding ensures that 3- and 5-pos. connectors are not accidentally connected to each other.



– Everything from a single source: Phoenix Contact supplies connectors for all the interfaces on a solar inverter.

Connection technology for field devices

Photovoltaic AC connectors

Cable connectors

- Snaps in automatically when inserted, released using a screwdriver
- Screw connection of 1.5 mm² to 6 mm²
- With lagging PE contact



3-pos.,
socket contacts



5-pos.,
socket contacts

| | Technical data | | | Technical data | | |
|--|--|-----------|-------------|--|-----------|-------------|
| General data | | | | | | |
| Degree of protection | IP65/IP68 | | | IP65/IP68 | | |
| Conductor cross section | 1.5 mm ² ... 6 mm ² | | | 1.5 mm ² ... 6 mm ² | | |
| Electrical data | | | | | | |
| Rated voltage | 690 V | | | 690 V | | |
| Rated current | 35 A | | | 30 A | | |
| Material data | | | | | | |
| Contact surface material | Silver-plated | | | Silver-plated | | |
| Material of grip body | PPE | | | PPE | | |
| Inflammability class according to UL 94 | V0 | | | V0 | | |
| Temperature data | | | | | | |
| Ambient temperature (operation) | -40°C ... 100°C (dependent on the derating curve) | | | -40°C ... 100°C (dependent on the derating curve) | | |
| | Ordering data | | | Ordering data | | |
| Description | Type | Order No. | Pcs. / Pkt. | Type | Order No. | Pcs. / Pkt. |
| Cable connector , with screw connection for cable diameter: | | | | | | |
| 8 mm ... 21 mm | PRC 3-FC-FS6 8-21 | 1410661 | 1 | PRC 5-FC-FS6 8-21 | 1410656 | 1 |
| 8 mm ... 12 mm | PRC 3-FC-FS6 8-12 | 1410658 | 1 | PRC 5-FC-FS6 8-12 | 1410629 | 1 |
| 12 mm ... 16 mm | PRC 3-FC-FS6 12-16 | 1409217 | 1 | PRC 5-FC-FS6 12-16 | 1409205 | 1 |
| 16 mm ... 25 mm | PRC 3-FC-FS6 16-21 | 1410659 | 1 | PRC 5-FC-FS6 16-21 | 1410655 | 1 |
| | Accessories | | | Accessories | | |
| Protective cap | PRC COVER F | 1409236 | 50 | PRC COVER F | 1409236 | 50 |
| Test plug , black, 1.5 mm ² ... 6 mm ² with screw connection, for cables with diameter 8 mm ... 21 mm | PRC 3-TC-FS6 8-21 | 1621326 | 50 | PRC 5-TC-FS6 8-21 | 1621325 | 50 |

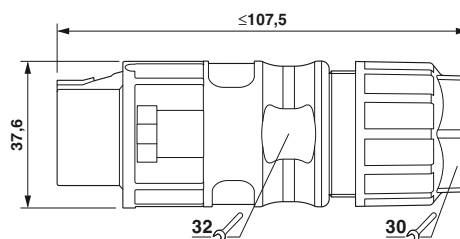
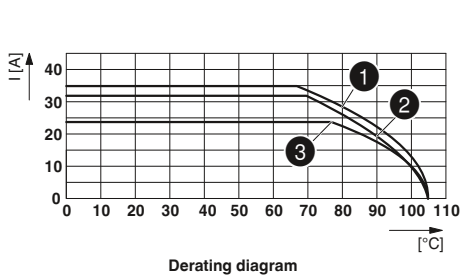

Device connectors

- Snaps in automatically when inserted, released using a screwdriver
- Pre-assembled with litz wires or for self-assembly
- IP65 when not plugged in
- With capacitive PE contact



Pin contacts with litz wires



Pin contact carrier without contacts

| General data | |
|---|--|
| Degree of protection (when plugged in) | |
| Electrical data | |
| Rated voltage | |
| Rated current | |
| Material data | |
| Contact surface material | |
| Material of grip body | |
| Inflammability class according to UL 94 | |
| Temperature data | |
| Ambient temperature (operation) | |

| Technical data | | | |
|--|--|--------|--|
| 3-pos. | | 5-pos. | |
| IP65/IP68 (2m/24h) | | | |
| 35 A | | 30 A | |
| Silver-plated | | | |
| PPE | | | |
| V0 | | | |
| -40°C ... 100°C (dependent on the derating curve) | | | |

| Technical data | | | |
|--|--|--------|--|
| 3-pos. | | 5-pos. | |
| IP65/IP68 (2m/24h) | | | |
| 35 A | | 30 A | |
| Silver-plated | | | |
| PPE | | | |
| V0 | | | |
| -40°C ... 100°C (dependent on the derating curve) | | | |

| Description | |
|---|--|
| M25 device connector incl. locking nut , cable length 150 mm, with conductor cross section: | |
| 2.5 mm ² | |
| 4 mm ² | |
| 6 mm ² | |
| Contact carrier incl. locking nut , without contacts, for crimp contacts, conductor cross section of 2.5 mm ² ... 6 mm ² | |

| Ordering data | | | |
|---------------|-------------|-----------|-------------|
| Order No. | Pcs. / Pkt. | Order No. | Pcs. / Pkt. |
| 3-pos. | | 5-pos. | |
| 1409219 | 10 | 1409211 | 10 |
| 1409220 | 10 | 1409212 | 10 |
| 1409221 | 10 | 1409213 | 10 |

| Ordering data | | | |
|---------------|-------------|-----------|-------------|
| Order No. | Pcs. / Pkt. | Order No. | Pcs. / Pkt. |
| 3-pos. | | 5-pos. | |
| 1409218 | 50 | 1409206 | 50 |

| Protective cap | |
|---|--|
| Replacement locking nut | |
| Crimp contacts CK 2,5 , silver-plated contact surface for conductor cross section: | |
| 2.5 mm ² | |
| 4 mm ² | |
| 6 mm ² | |

| Accessories | | | |
|----------------------|--|---------|-----|
| PRC COVER M | | 1409237 | 50 |
| FT NUT M25 BK | | 1457937 | 100 |

| Accessories | | | |
|-----------------------|--|---------|-----|
| PRC COVER M | | 1409237 | 50 |
| FT NUT M25 BK | | 1457937 | 100 |
| CK2,5-M-2,5 AG | | 1409207 | 100 |
| CK2,5-M-4 AG | | 1409208 | 100 |
| CK2,5-M-6 AG | | 1409209 | 100 |

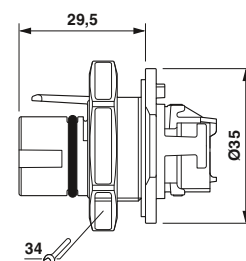
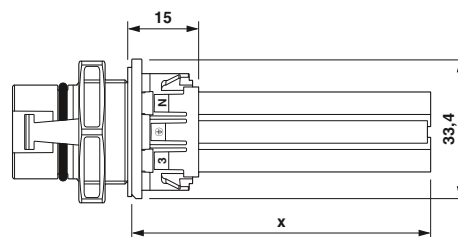
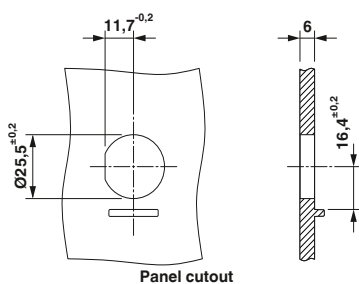



The development of a widespread charging infrastructure in conjunction with renewable energy is an important step toward a mobile future. Internationally standardized charging systems are used to establish an electrical connection between the electric vehicle and the infrastructure (e.g., a charging station). In terms of the charging interfaces required, a distinction is made between:

- Vehicle inlets
- Socket outlets on the charging station
- Charging cables with connectors (charging plug on the vehicle), plugs (charging plug in the infrastructure), and integrated IC-CPD control units.

International standards ensure uniform connection for charging stations and vehicles:

- Type 1 according to SAE J1772 (USA, Japan)
- Type 2 according to IEC-62196 (Europe)
- GB standard (China).

The charging plugs from Phoenix Contact offer reliable, standard-compliant solutions for a consistent charging interface for all applications.

This is implemented, for example, with the Combined Charging System (CCS), which was developed by major German automobile manufacturers in cooperation with Phoenix Contact. The electric vehicle can be charged conventionally with AC at home, for example. In addition, the vehicle-side inlet is also designed for rapid DC charging. Only short stops are required for the charging process - e.g., on the go at rest stops.



AC type 1

The type 1 AC charging system is based on standard SAE J1772. It is primarily used in the USA and Japan. The lock is implemented using a lever system.



AC type 2

The type 2 AC charging system, developed for Europe, is designed according to the IEC 62196-2 standard. It supports single- and three-phase charging. An electromechanical actuator lock safeguards the charging process.



AC GB

The AC charging system standardized according to the Chinese GB standard enables both single- and three-phase charging. Charging takes place securely thanks to a special lever system.



DC CCS type 1

In the USA, the type 1 DC CCS charging system is used for fast DC charging, according to SAE J1772 and IEC 62196-3. The lever locking mechanism is also supported by an additional actuator lock.



DC CCS type 2

In Europe, the type 2 DC CCS charging system is the vanguard for rapid DC charging according to IEC-62196-3. The electromechanical actuator lock prevents premature removal during the charging process.



DC GB

The DC GB charging system is based on the GB standard. It offers rapid DC charging for Chinese charging stations. The lever lock is also supported by an additional actuator lock.

Connection technology for field devices

Charging cables for electric vehicles

Type 1 AC charging cables with open cable end

Type 1 AC charging cables with open cable end are primarily installed in charging stations and wall boxes in the USA and Japan. They are used to charge electric vehicles with alternating current.

| Notes: |
|---|
| Further cable types and lengths are available on request. |
| Color variants for housing and cables are available on request. |
| Additional charging cables with higher rated currents are available on request. |
| All connectors are supplied with a protective cap. |



Type 1 AC connector, with AWG cable



Type 1 AC connector, with metric cable

| | Technical data | | Technical data | | | | | |
|---|--|--|--|--|-----------|-------------|-----------|-------------|
| | 16 A | 30 A | 20 A | 32 A | | | | |
| Rated current | 16 A | 30 A | 20 A | 32 A | | | | |
| Number of phases | 1 | 1 | 1 | 1 | | | | |
| Rated voltage | 240 V AC | 240 V AC | 250 V AC | 250 V AC | | | | |
| Standards | SAE J1772 | SAE J1772 | SAE J1772 | SAE J1772 | | | | |
| Charging mode | AC level 2 | AC level 2 | Mode 3 | Mode 3 | | | | |
| Resistor coding | 150 Ω (Lever actuated) 480 Ω (Lever not actuated) | 150 Ω (Lever actuated) 480 Ω (Lever not actuated) | 150 Ω (Lever actuated) 480 Ω (Lever not actuated) | 150 Ω (Lever actuated) 480 Ω (Lever not actuated) | | | | |
| Ambient temperature (Operation) | -30°C ... 50°C | -30°C ... 50°C | -30°C ... 50°C | -30°C ... 50°C | | | | |
| Number of power contacts | 3 (L1, N, PE) | 3 (L1, N, PE) | 3 (L1, N, PE) | 3 (L1, N, PE) | | | | |
| Insertion/withdrawal cycles | > 10000 | > 10000 | > 10000 | > 10000 | | | | |
| Insertion/withdrawal force | < 100 N | < 100 N | < 100 N | < 100 N | | | | |
| Type of protection (when plugged in) | IP44 | IP44 | IP44 | IP44 | | | | |
| Degree of protection (with protective cap) | IP24 | IP24 | IP24 | IP24 | | | | |
| Degree of protection (when not plugged in) | IP20 | IP20 | IP20 | IP20 | | | | |
| Cable data | | | | | | | | |
| Cable type | Straight | Straight | Spiraled | Spiraled | | | | |
| Cable length | 4 m | 4 m | 4 m | 4 m | | | | |
| Cable diameter | 9.4 mm ± 0.2 | 16.4 mm ± 0.2 | 10.5 mm ± 0.5 | 13.9 mm ± 0.5 | | | | |
| Cable structure | 3 x 14 AWG + 1 x 18 AWG | 3 x 10 AWG + 1 x 18 AWG | 3 x 2.5 mm ² + 1 x 0.5 mm ² | 3 x 6.0 mm ² + 1 x 0.5 mm ² | | | | |
| Sheath color | Black | Black | Black | Black | | | | |
| Ordering data | | | | | | | | |
| Description | Order No. | Pcs. / Pkt. | Order No. | Pcs. / Pkt. | Order No. | Pcs. / Pkt. | Order No. | Pcs. / Pkt. |
| | 16 A | | 30 A | | 20 A | | 32 A | |
| AC charging cable with open cable end, mode 3, type 1 | 1621484 | 1 | 1409949 | 1 | 1621670 | 1 | 1621794 | 1 |

Type 2 AC charging cables with open cable end

Type 2 AC charging cables with open cable end are installed in charging stations and wall boxes in European infrastructure. They are used to charge electric vehicles with alternating current.

| |
|---|
| Notes: |
| Further cable types and lengths are available on request. |
| Color variants for housing and cables are available on request. |
| Additional charging cables with higher rated currents are available on request. |
| All connectors are supplied with a protective cap. |



Type 2 AC connector, 20 A



Type 2 AC connector, 32 A



| | | |
|--|---|---|
| Rated current | 20 A | 20 A |
| Number of phases | 1 | 3 |
| Rated voltage | 250 V AC | 480 V AC |
| Standards | IEC 62196-2 | IEC 62196-2 |
| Charging mode | Mode 3 | Mode 3 |
| Resistor coding | 680 Ω (between PE and PP) | 680 Ω (between PE and PP) |
| Ambient temperature (Operation) | -30°C ... 50°C | -30°C ... 50°C |
| Number of power contacts | 3 (L1, N, PE) | 5 (L1, L2, L3, N, PE) |
| Insertion/withdrawal cycles | > 10000 | > 10000 |
| Insertion/withdrawal force | < 100 N | < 100 N |
| Type of protection (when plugged in) | IP44 | IP44 |
| Degree of protection (with protective cap) | IP24 | IP24 |
| Degree of protection (when not plugged in) | IP20 | IP20 |
| Cable data | | |
| Cable type | Straight | Straight |
| Cable length | 4 m | 4 m |
| Cable diameter | 10.5 mm ±0.5 | 13 mm ±0.5 |
| Cable structure | 3 x 2.5 mm ² + 1 x 0.5 mm ² | 5 x 2.5 mm ² + 1 x 0.5 mm ² |
| Sheath color | Black | Black |

| Technical data | |
|--|---|
| 20 A | 20 A |
| Rated current | 20 A |
| Number of phases | 3 |
| Rated voltage | 480 V AC |
| Standards | IEC 62196-2 |
| Charging mode | Mode 3 |
| Resistor coding | 680 Ω (between PE and PP) |
| Ambient temperature (Operation) | -30°C ... 50°C |
| Number of power contacts | 5 (L1, L2, L3, N, PE) |
| Insertion/withdrawal cycles | > 10000 |
| Insertion/withdrawal force | < 100 N |
| Type of protection (when plugged in) | IP44 |
| Degree of protection (with protective cap) | IP24 |
| Degree of protection (when not plugged in) | IP20 |
| Cable data | |
| Cable type | Straight |
| Cable length | 4 m |
| Cable diameter | 13 mm ±0.5 |
| Cable structure | 5 x 2.5 mm ² + 1 x 0.5 mm ² |
| Sheath color | Black |

| Technical data | |
|--|---|
| 32 A | 32 A |
| Rated current | 32 A |
| Number of phases | 3 |
| Rated voltage | 480 V AC |
| Standards | IEC 62196-2 |
| Charging mode | Mode 3 |
| Resistor coding | 220 Ω (between PE and PP) |
| Ambient temperature (Operation) | -30°C ... 50°C |
| Number of power contacts | 5 (L1, L2, L3, N, PE) |
| Insertion/withdrawal cycles | > 10000 |
| Insertion/withdrawal force | < 100 N |
| Type of protection (when plugged in) | IP44 |
| Degree of protection (with protective cap) | IP24 |
| Degree of protection (when not plugged in) | IP20 |
| Cable data | |
| Cable type | Straight |
| Cable length | 4 m |
| Cable diameter | 17 mm ±0.5 |
| Cable structure | 5 x 6 mm ² + 1 x 0.5 mm ² |
| Sheath color | Black |

| Description | Ordering data | |
|--|----------------|-------------|
| | Order No. | Pcs. / Pkt. |
| AC charging cable with open cable end, mode 3, type 2 | | |
| | 1409319 | 1 |

| Description | Ordering data | |
|--|----------------|-------------|
| | Order No. | Pcs. / Pkt. |
| AC charging cable with open cable end, mode 3, type 2 | | |
| | 1409320 | 1 |

| Description | Ordering data | |
|--|----------------|-------------|
| | Order No. | Pcs. / Pkt. |
| AC charging cable with open cable end, mode 3, type 2 | | |
| | 1405198 | 1 |

Connection technology for field devices

Charging cables for electric vehicles

Type 1 and type 1 mobile AC charging cables (mode 3)

The mobile AC charging cables enable electric vehicles to be charged with alternating current at European charging stations or wall boxes at home and while on the move. They can easily be stored inside the vehicle.

| |
|---|
| Notes: |
| Further cable types and lengths are available on request. |
| Color variants for housing and cables are available on request. |
| All connectors and plugs are supplied with a protective cap. |



Type 1 AC connector with type 2 plug



Type 2 AC connector with type 2 plug



| | Technical data | | Technical data | |
|--|---|---|---|---|
| | 20 A | 32 A | 20 A | 32 A |
| Rated current | 20 A | 32 A | 20 A | 32 A |
| Number of phases | 1 | 1 | 1 | 3 |
| Rated voltage | 250 V AC | 250 V AC | 250 V AC | 480 V AC |
| Standards | IEC 62196-2 | IEC 62196-2 | IEC 62196-2 | IEC 62196-2 |
| Charging mode | Mode 3 | Mode 3 | Mode 3 | Mode 3 |
| Ambient temperature (Operation) | -30°C ... 50°C | -30°C ... 50°C | -30°C ... 50°C | -30°C ... 50°C |
| Number of power contacts | 3 (L1, N, PE) | 3 (L1, N, PE) | 3 (L1, N, PE) | 5 (L1, L2, L3, N, PE) |
| Insertion/withdrawal cycles | > 10000 | > 10000 | > 10000 | > 10000 |
| Insertion/withdrawal force | < 100 N | < 100 N | < 100 N | < 100 N |
| Type of protection (when plugged in) | IP44 | IP44 | IP44 | IP44 |
| Degree of protection (with protective cap) | IP24 | IP24 | IP24 | IP24 |
| Degree of protection (when not plugged in) | IP20 | IP20 | IP20 | IP20 |
| Cable data | | | | |
| Cable type | Straight | Straight | Straight | Straight |
| Cable length | 4 m | 4 m | 4 m | 4 m |
| Cable diameter | 10.5 mm ±0.5 | 13.9 mm ±0.5 | 10.5 mm ±0.5 | 17 mm ±0.5 |
| Cable structure | 3 x 2.5 mm ² + 1 x 0.5 mm ² | 3 x 6 mm ² + 1 x 0.5 mm ² | 3 x 2.5 mm ² + 1 x 0.5 mm ² | 5 x 6 mm ² + 1 x 0.5 mm ² |
| Sheath color | Black | Black | Black | Black |
| Ordering data | | | | |
| Description | Order No. | Pcs. / Pkt. | Order No. | Pcs. / Pkt. |
| | 20 A | | 32 A | |
| AC charging cable with plug, mode 3 | 1621481 | 1 | 1410090 | 1 |
| | | | | |
| Ordering data | | | | |
| Description | Order No. | Pcs. / Pkt. | Order No. | Pcs. / Pkt. |
| | 20 A | | 32 A | |
| AC charging cable with plug, mode 3 | 1405193 | 1 | 1404569 | 1 |
| | | | | |

Type 1 and type 2 mobile AC charging cables (mode 2)

The mobile AC charging cables with In Cable Control and Protection Device (IC-CPD) enable electric vehicles to be charged with alternating current at a normal, European socket at home and while on the move. Standardized communication with the vehicle as well as the safety equipment are integrated in the IC-CPD.



Type 1 AC connector with IC-CPD and SCHUKO plug



Type 2 AC connector with IC-CPD and SCHUKO plug

Notes:
All connectors are supplied with a protective cap.

| | Technical data | | | Technical data | | |
|---|---|-------------------------------|--------------------|---|------------------|--------------------------|
| Rated current | 6 A ... 13 A | | | 6 A ... 13 A | | |
| Number of phases | 1 | | | 1 | | |
| Rated voltage | 200 V AC ... 250 V AC | | | 200 V AC ... 250 V AC | | |
| Frequency | 50 Hz | | | 50 Hz | | |
| Charging power | 1.4 kW ... 3 kW | | | 1.4 kW ... 3 kW | | |
| Standards | IEC 61851-1 | | | IEC 61851-1 | | |
| Charging mode | Mode 2 | | | Mode 2 | | |
| Ambient temperature (Operation) | -30°C ... 40°C | | | -30°C ... 40°C | | |
| Tripping characteristics / residual current | Type A/30 mA | | | Type A/30 mA | | |
| Infrastructure plug | SCHUKO (type AF) | | | SCHUKO (type AF) | | |
| Temperature sensor (infrastructure plug) | Available | | | Available | | |
| Degree of protection (IC-CPD) | IP67 | | | IP67 | | |
| Type of protection (when plugged in) | IP44 | | | IP44 | | |
| Degree of protection (with protective cap) | IP24 | | | IP24 | | |
| Degree of protection (when not plugged in) | IP20 | | | IP20 | | |
| Cable data | | | | | | |
| Cable type | Straight | | | Straight | | |
| Cable length | 4 m | | | 4 m | | |
| Cable diameter | 10.5 mm ±0.5 | | | 10.5 mm ±0.5 | | |
| Cable structure | 3 x 2.5 mm ² + 2 x 0.5 mm ² | | | 3 x 2.5 mm ² + 2 x 0.5 mm ² | | |
| Sheath color | Red | | | Red | | |
| Ordering data | | | | | | |
| Description | Type | Order No. | Pcs. / Pkt. | Type | Order No. | Pcs. / Pkt. |
| | AC charging cable with IC-CPD, mode 2 | EV-ICCPD-T1C-EU-S-13A1-A-GEN2 | 1621797 | | 1 | EV-ICCPD-T2C-EU-S-13A1-A |

Connection technology for field devices

Charging cables for electric vehicles

Combined charging system (CCS) DC charging cables type 1 and type 2

The CCS DC charging cables with open cable end are connected directly to a DC charging station. They are suitable for fast DC charging of electric vehicles.

The CCS connector is compatible with the CCS inlet, which also accommodates an AC connector.



**Type 1 combined DC connector,
with AWG cable**



**Type 2 combined DC connector,
with metric cable**

| |
|---|
| Notes: |
| Further cable types and lengths are available on request. |
| Color variants for housing and cables are available on request. |

| | Technical data | | | Technical data | | |
|--|--|--|--|--|--|--|
| | 60 A | 125 A | 200 A | 60 A | 125 A | 200 A |
| Rated current | 60 A | 125 A | 200 A | 60 A | 125 A | 200 A |
| Rated voltage | 600 V DC | 600 V DC | 600 V DC | 850 V DC | 850 V DC | 850 V DC |
| Standards | SAE J1772 | SAE J1772 | SAE J1772 | IEC 62196-3 | IEC 62196-3 | IEC 62196-3 |
| Charging mode | DC level 2 | DC level 2 | DC level 2 | Mode 4 | Mode 4 | Mode 4 |
| Resistor coding | 150 Ω (Lever actuated) 480 Ω (Lever not actuated) | 150 Ω (Lever actuated) 480 Ω (Lever not actuated) | 150 Ω (Lever actuated) 480 Ω (Lever not actuated) | 1500 Ω (between PE and PP) | 1500 Ω (between PE and PP) | 1500 Ω (between PE and PP) |
| Ambient temperature (Operation) | -30°C ... 50°C | -30°C ... 50°C | -30°C ... 50°C | -30°C ... 50°C | -30°C ... 50°C | -30°C ... 50°C |
| Number of power contacts | 3 (PE, DC+, DC-) | 3 (PE, DC+, DC-) | 3 (PE, DC+, DC-) | 3 (PE, DC+, DC-) | 3 (PE, DC+, DC-) | 3 (PE, DC+, DC-) |
| Insertion/withdrawal cycles | > 10000 | > 10000 | > 10000 | > 10000 | > 10000 | > 10000 |
| Insertion/withdrawal force | < 100 N | < 100 N | < 100 N | < 100 N | < 100 N | < 100 N |
| Temperature sensor | Pt1000 | Pt1000 | Pt1000 | Pt1000 | Pt1000 | Pt1000 |
| Type of protection (when plugged in) | IP44 | IP44 | IP44 | IP44 | IP44 | IP44 |
| Degree of protection (when not plugged in) | IP20 | IP20 | IP20 | IP24 | IP24 | IP24 |
| Cable data | | | | | | |
| Cable type | Straight | Straight | Straight | Straight | Straight | Straight |
| Cable length | 5 m | 5 m | 5 m | 4,5 m | 5 m | 5 m |
| Cable diameter | 20.6 mm ± 0.2 | 32.2 mm ± 0.2 | 37.4 mm ± 0.2 | 19 mm ± 0.2 | 28.2 mm ± 0.2 | 32 mm ± 0.2 |
| Cable structure | 3 x 6 AWG + 3 x 2 x 18 AWG | 2 x 1 AWG + 1 x 3 AWG + 3 x 2 x 18 AWG | 2 x 00 AWG + 1 x 1 AWG + 3 x 2 x 18 AWG | 3 x 16 mm ² + 3 x 2 x 0.75 mm ² | 2 x 50 mm ² + 1 x 25 mm ² + 3 x 2 x 0.75 mm ² | 2 x 70 mm ² + 1 x 35 mm ² + 3 x 2 x 0.75 mm ² |
| Sheath color | Black | Black | Black | Black | Black | Black |
| | Ordering data | | | Ordering data | | |
| Description | Order No. | Pcs. / Pkt. | Order No. | Pcs. / Pkt. | Order No. | Pcs. / Pkt. |
| | 60 A | | 125 A | | 200 A | |
| DC charging cable with open cable end, combined charging system (CCS) | 1621488 | 1 | 1409950 | 1 | 1621489 | 1 |
| | | | | | 1618306 | 1 |
| | | | | | 1409060 | 1 |
| | | | | | 1621653 | 1 |

**DC charging cables
GB standard (China)**

DC GB charging cables with open cable end are installed in Chinese charging stations with a stationary AC/DC converter. They are suitable for fast DC charging of electric vehicles.



**DC GB connector,
with metric cable**

| |
|---|
| Notes: |
| Further cable types and lengths are available on request. |
| Color variants for housing and cables are available on request. |

| Technical data | |
|--------------------------------------|--|
| Rated current | 60 A |
| Rated voltage | 750 V DC |
| Standards | GB/T Part 3 |
| Charging mode | Mode 4 |
| Resistor coding | 1000 Ω |
| Ambient temperature (Operation) | -30°C ... 50°C |
| Number of power contacts | 3 |
| Insertion/withdrawal cycles | > 10000 |
| Insertion/withdrawal force | < 100 N |
| Type of protection (when plugged in) | IP55 |
| Cable data | |
| Cable type | Straight |
| Cable length | 5 m |
| Cable diameter | 20,2 mm ± 0.2 |
| Cable structure | 3 x 16 mm ² + 2 x 2.5 mm ² + 9 x 0.5 mm ² |
| Sheath color | Black |

| Ordering data | | | |
|--|-----------------------------|-----------|-------------|
| Description | Type | Order No. | Pcs. / Pkt. |
| DC charging cable with open cable end, GB/T | | | |
| | EV-GBM4C-DC60A-5,0M16ESBK00 | 1621468 | 1 |



FAME plug-in test system with push-in connection, for wall and DIN rail mounting

PT ... Page 92



FAME plug-in test system with screw connection, for wall and DIN rail mounting

UT ... Page 94



FAME test plug, multi-position, freely configurable contact tabs

FTPR ..., FTP ... Page 96



Ordering example for configurable test plugs with twist grip or standard grip

Page 97



Blind plugs, coding profile, and colored test sockets

Page 98



Accessories
Bridges and cover profiles

Page 100



FAME plug-in test system with push-in connection, VDE types, for wall and DIN rail mounting

PT ... Page 102



FAME plug-in test system with screw connection, VDE types, for wall and DIN rail mounting

UT ... Page 128

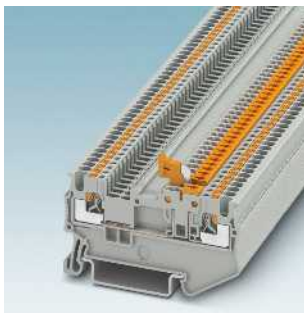

Push-in knife disconnect terminal blocks

PT 1,5..., PTT 1,5... Page 156

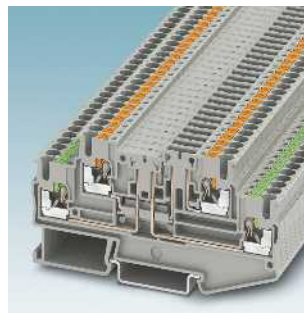

Push-in double-level disconnect and knife disconnect terminal blocks

PTT 2,5... Page 158

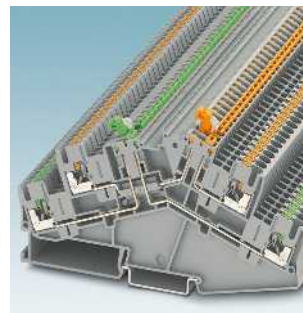

Push-in double-level disconnect and knife disconnect terminal blocks in desk design

PTTBS ... Page 160



Screw connection disconnect and knife disconnect terminal blocks with fuse plug

UT ...-TG Page 162
UTT ...-TG Page 164

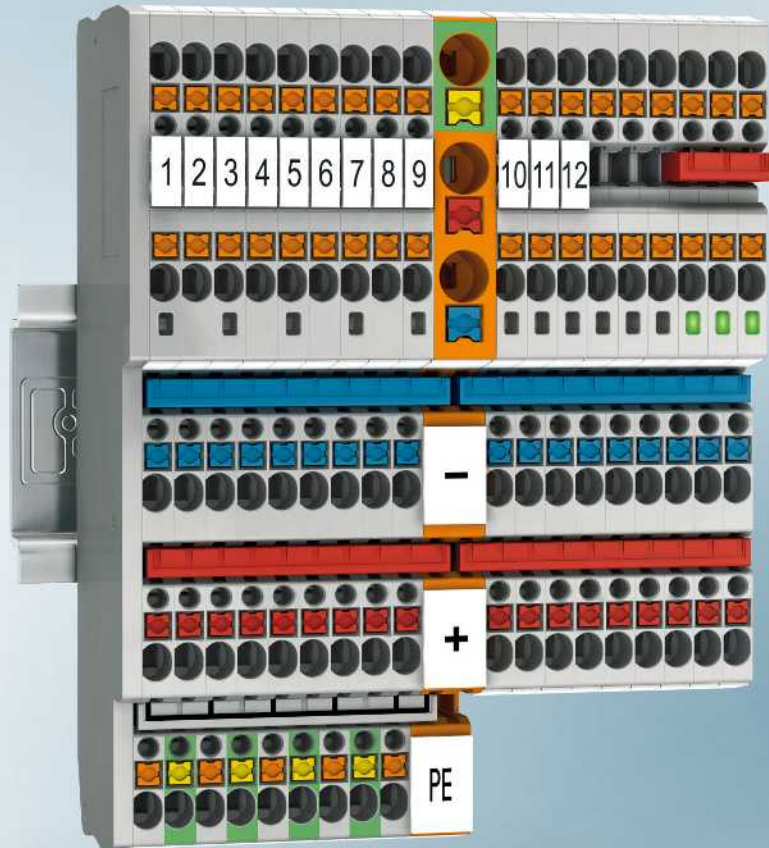

Screw connection multi-level function and lever-type fuse terminal blocks with PE foot

UT 4...-TG/MT
UT 4...-HESI

Page 166
Page 168



Fast connection hybrid knife disconnect terminal block with single-sided screw connection

QTCU 2,5-TWIN-MT

Page 172

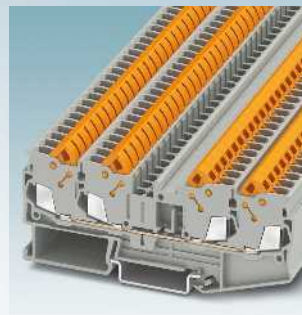

Fast connection feed-through and ground terminal blocks

QTC 2,5-QUATTRO

Page 173

Modular terminal blocks

FAME plug-in test system

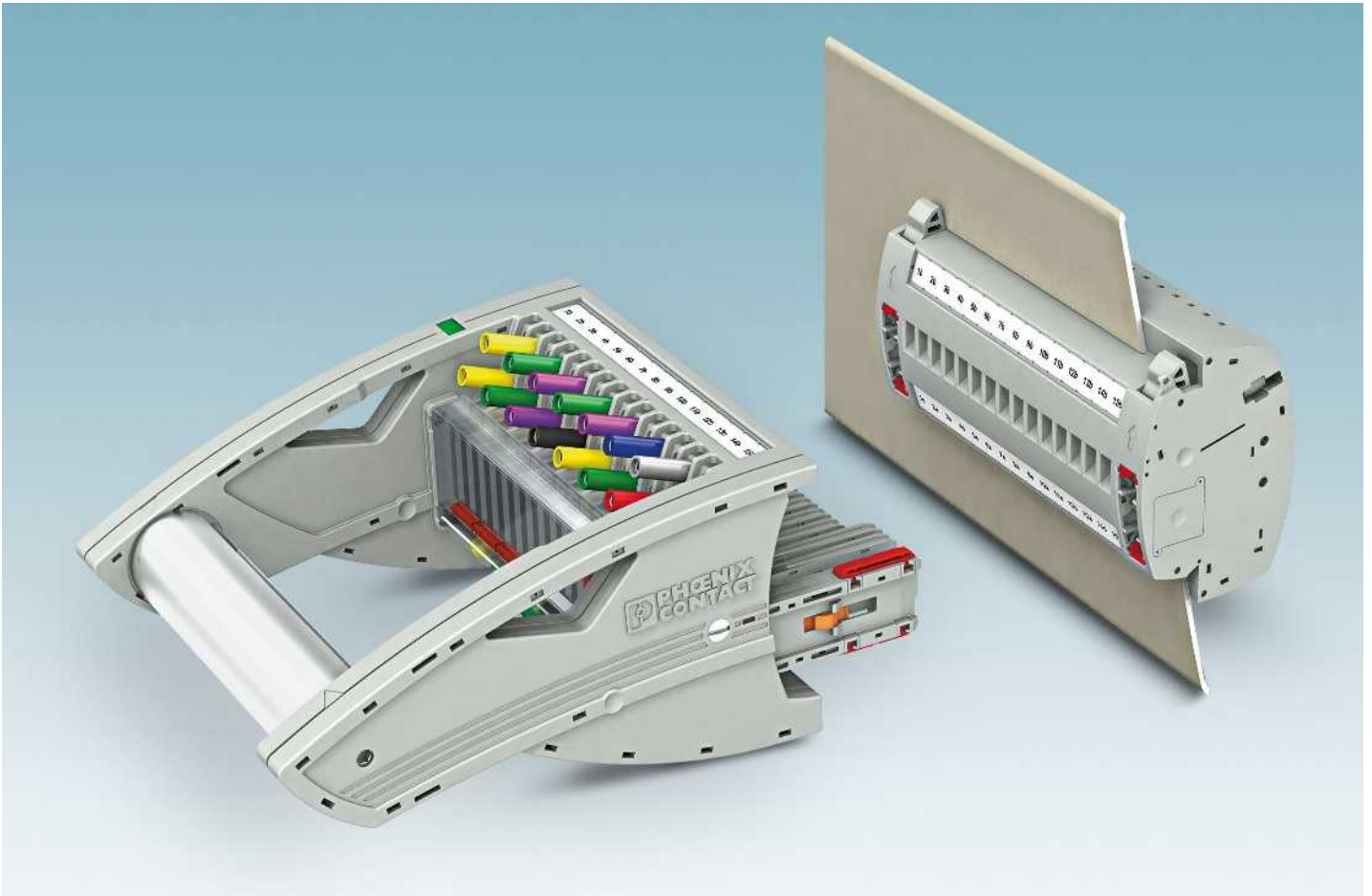

FAME is the innovative test system for all measuring and testing tasks in network protection technology for medium and high-voltage switchgear. With the modular system, you can now perform manual testing automatically, safely, and more quickly. Suitable for every application, the modular system can be directly integrated into the control cabinet panel or used as a DIN rail version.



The test plug is completely inserted and engaged, the display window turns red. All test contacts are contacted according to the test setup.



The twist grip is turned upward as far as it will go, the display window turns yellow. Test contacts with short contact tab lengths (e.g., current transformers) are once again connected to the protective device.



The twist grip must be turned back to its starting position. Now the mechanism releases the plug so it can be fully removed. The display window turns green.



Preprogrammed short-circuit and switching operations depend on consistent insertion and removal of the test plug. Undefined contact states are effectively avoided thanks to the twist grip mechanism.



The patented wall fastening is easy to use and has a robust design. Even tolerances in the panel cutout of up to 4 mm are compensated.



The offset test socket arrangement enables the use of CAT III and CAT IV/1000 V safety test leads according to EN 61010-031 in a confined space.



FAME test terminal strips have an IP20 design. Blind plugs without switching function can be inserted and secured with seals. These can only be released with two-hand operation.



In addition to the two marking grooves, the test terminal strips for wall mounting also offer two function shafts, or six function shafts in the case of the DIN rail version, inside the control cabinet for forming and grounding the star point.



The compact and modular design of the system, as well as the plugs and test terminal strips, provides an extensive range of options for every application with positions from 4 to 25.



All applications which do not involve testing through the closed door and the open rack mounting can be implemented with the DIN rail version. Terminal points and plug-in zone can be operated from one direction.



The test plug provides three function shafts between the 4 mm test contacts. Horizontally aligned, as leading short-circuit jumper - vertically aligned as through connection in the plug.



The coding profiles can be applied by the user according to their application. VDE-compliant versions are pre-coded on delivery. This ensures maximum safety.

FAME 2 – safe in every operating state

The new, modular FAME measuring transducer test system enables all transformer testing tasks to be carried out quickly and safely.

The automatically generated transformer short circuit, the twist grip mechanism, and the shock-proof design provide maximum safety during measurement.

Normal operation

Closed N/O contact

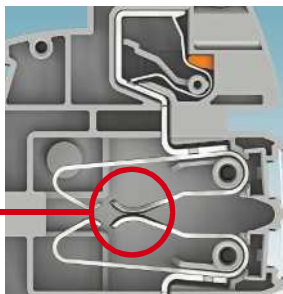

Transformer short circuit

Leading short circuit by means of auxiliary contact

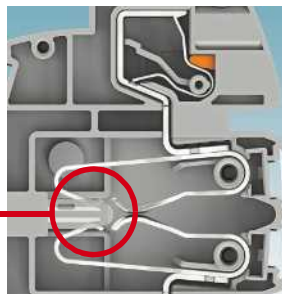

Test operation

N/O contact connected via test socket

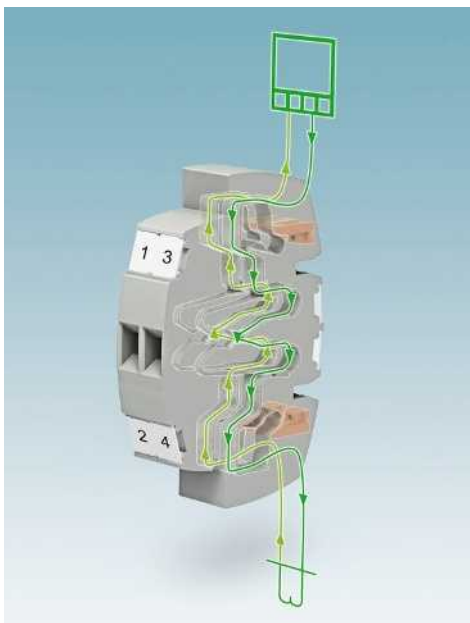
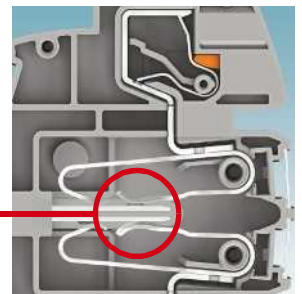

Due to the N/C contact function of the FAME 2 system, additional power plugs are not required for normal operation. If desired, the plug-in zone can be covered with a blind plug to prevent unauthorized access.

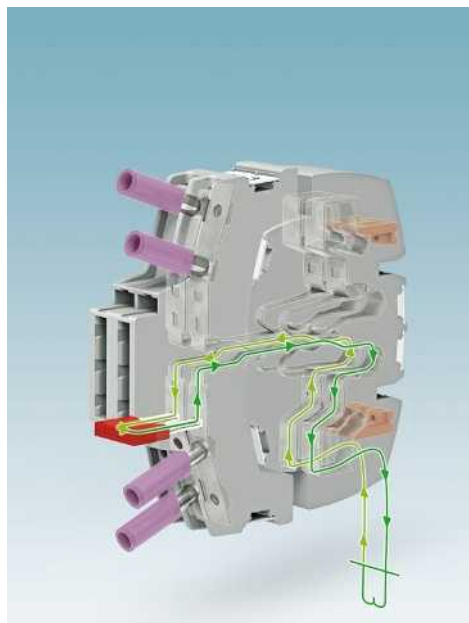

When replacing the protective device or even in the case of a relay test, a leading short circuit of the current transformer (for the purpose of signal splitting) can be easily carried out by means of a jumper inserted crossways.

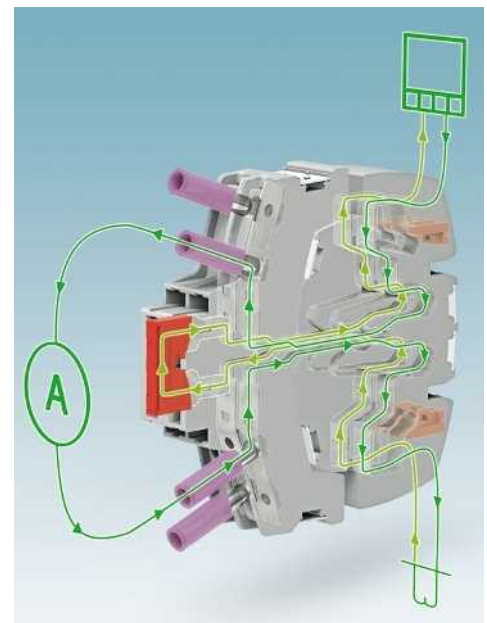

With the jumper simply inserted lengthways in the test plug, test equipment can be easily looped into the current path via the 4 mm test sockets.

Medium-voltage circuit example with star point grounding in the test terminal strip

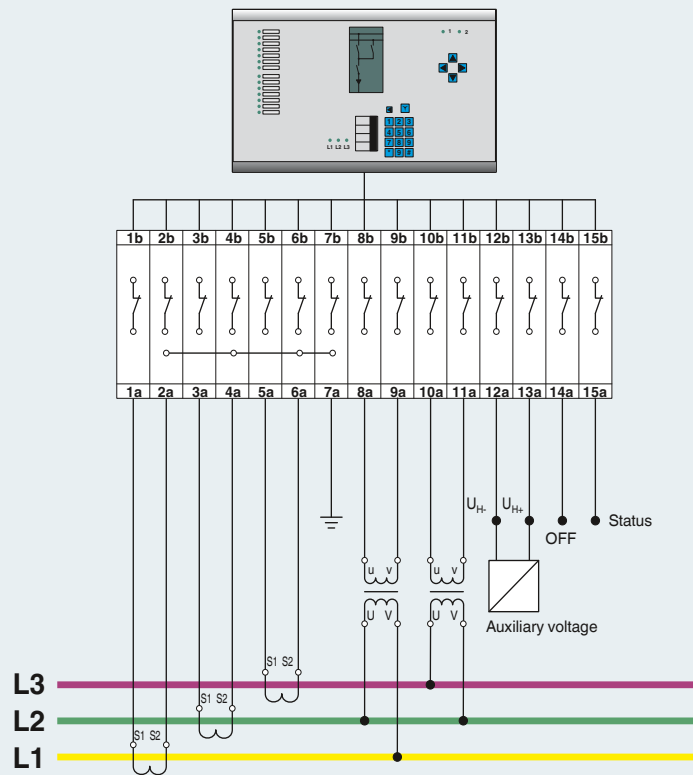

Test terminal strip with current transformer, voltage transducer, and signals

Test plug with current transformer, voltage transducer, and signals

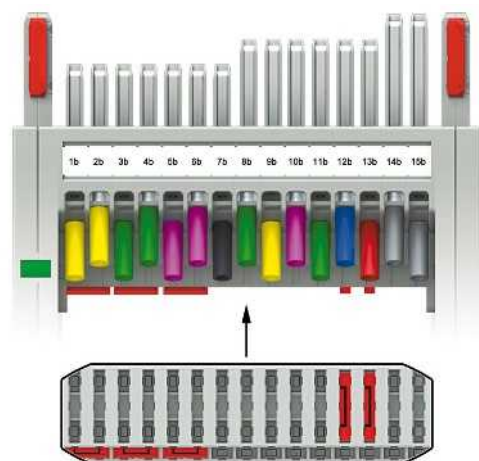
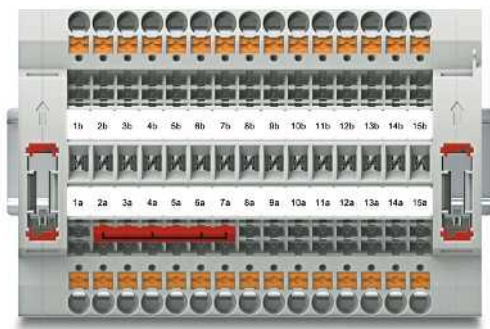

Test terminal strip, blind plug

| Order No. | Type | Required quantity |
|-----------|-------------|-------------------|
| 3069864 | PTRE 6-2/15 | 1 |
| 3069886 | FBP 2/15 | 1 |

Jumper

| | | |
|---------|---------|---|
| 3032470 | FBS 6-8 | 1 |
|---------|---------|---|

Test plug

| Order No. | Type | Required quantity |
|-----------|-----------|-------------------|
| 3001693 | FTPR 2/15 | 1 |

Jumper

| | | |
|---------|---------|---|
| 3030284 | FBS 2-8 | 3 |
| 3030297 | FBS 3-8 | 2 |

FAME plug-in test system

Test terminal strip, multi-position with PT ... push-in connection, for PTWE ... wall mounting



The modular FAME measuring transducer test system, with the innovative push-in connection technology, enables all transformer testing tasks to be carried out quickly and safely. The transformer is short-circuited and the testing device is looped in automatically through the insertion process.

- The test terminal strips can be used universally for current and voltage transducers
- The test terminal strip can be mounted on the control cabinet door or on the DIN rail
- Signal and status messages can be wired in combination in a test terminal strip
- The correct switching sequence when removing the test plug is ensured by a locking device and a mechanical drive in the twist grip
- All test signals can be connected with touch-proof safety test leads (CAT III and CAT IV/1000 V according to EN 61010-031)
- All versions listed can be equipped with coding for the matching test plug
- Star points of the current transformer can easily be created in the test terminal strip on the rear by means of FBS jumpers.
- You can find corresponding accessories from page 99

| Notes: |
|---|
| To create panel cutouts, see phoenixcontact.net/products. |
| 1) Derating curve available on request. |
| 2) Rated surge voltage of 5 kV. |



6 (10) mm², 30 A, 4 ... 25-pos. test terminal strip, for wall mounting

| Max. electrical data | |
|---|--|
| Rated data | |
| Rated voltage | [V] 400 ²⁾ |
| Nominal current / cross section | [A] / [mm ²] 24 ¹⁾ /6 |
| Rated cross section | [mm ²] 6 |
| Cross section range | AWG 20 - 8 |
| Connection capacity | |
| 1 conductor | [mm ²] 0.5 - 10 |
| 2 stranded conductors with a TWIN ferrule | [mm ²] 0.5 - 6 |
| Plug-in connection cross sections | [mm ²] 1 - 10 |
| General data | |
| Stripping length | [mm] 12 |
| Tightening torque for wall fastening | [Nm] 0.8 - 1 |
| Panel thickness | [mm] 1 - 4 |
| Insulating material | PA |
| Inflammability class according to UL 94 | V0 |

| Technical data | | | |
|----------------------------|----------------------|-----------------------------|----------------|
| I _{max} [A] | U _{max} [V] | max. Ø [mm ²] | AWG |
| 30 | 400 ²⁾ | 0.5 - 10 | 20 - 8 |
| IEC 60947-7-1 | | | |
| IEC | UL/CUL | CSA | IEC/EN 60079-7 |
| Connection capacity | | | |
| | | ferrule | |
| | | with/without plastic sleeve | |
| solid | stranded | 0.5 - 6 | 0.5 - 6 |
| 1 - 10 | - | 1 - 6 | 1 - 6 |

| Description | No. of pos. | Color |
|---|-------------|-------|
| Test terminal strip , for wall mounting, | | |
| 4-pos. | | gray |
| 5-pos. | | gray |
| 9-pos. | | gray |
| 10-pos. | | gray |
| 12-pos. | | gray |
| 14 pos. | | gray |
| 15-pos. | | gray |
| 17-pos. | | gray |
| 19 pos. | | gray |
| 20 pos. | | gray |
| 21 pos. | | gray |
| 22 pos. | | gray |
| 25 pos. | | gray |

| Ordering data | | | |
|---------------|------------------|-----------|-------------|
| Type | I _{max} | Order No. | Pcs. / Pkt. |
| PTWE 6-2/4 | | 3069827 | 1 |
| PTWE 6-2/5 | | 3069828 | 1 |
| PTWE 6-2/9 | | 3069832 | 1 |
| PTWE 6-2/10 | | 3069833 | 1 |
| PTWE 6-2/12 | | 3069835 | 1 |
| PTWE 6-2/14 | | 3069837 | 1 |
| PTWE 6-2/15 | | 3069838 | 1 |
| PTWE 6-2/17 | | 3069840 | 1 |
| PTWE 6-2/19 | | 3069842 | 1 |
| PTWE 6-2/20 | | 3069843 | 1 |
| PTWE 6-2/21 | | 3069844 | 1 |
| PTWE 6-2/22 | | 3069845 | 1 |
| PTWE 6-2/25 | | 3069848 | 1 |

| Jumper | No. of pos. | Color |
|--|-------------|-------------|
| | 2 | red |
| | 3 | red |
| | 4 | red |
| | 5 | red |
| | 6 | red |
| | 10 | red |
| Jumper | 16 | red |
| Pre-assembled bridge , labeled | | |
| 3-pos., positions 1, 3 | 3 | red |
| 4-pos., positions 1, 4 | 4 | red |
| 5-pos., positions 1, 3, 5 | 5 | red |
| 10-pos., positions 1, 4, 7, 10 | 10 | red |
| Cover profile , supply length 1 m | | transparent |
| Cover profile holder , can be snapped on and sealed | | gray |
| Screwdriver | | |
| | | |

| Accessories | | | |
|-------------------|------------------|-----------|-------------|
| Type | I _{max} | Order No. | Pcs. / Pkt. |
| FBS 2-8 | 24 A | 3030284 | 10 |
| FBS 3-8 | 24 A | 3030297 | 10 |
| FBS 4-8 | 24 A | 3030307 | 10 |
| FBS 5-8 | 24 A | 3030310 | 10 |
| FBS 6-8 | 24 A | 3032470 | 10 |
| FBS 10-8 | 24 A | 3030323 | 10 |
| FBSR 16-8 | 24 A | 3033816 | 10 |
| FBS 1/3-8 | 24 A | 3032363 | 10 |
| FBS 1/4-8 | 24 A | 3032376 | 10 |
| FBS 1/3/5-8 | 24 A | 3032389 | 10 |
| FBS 1/4/7/10-8 | 24 A | 3032402 | 10 |
| AP RSC-T | | 3059139 | 10 |
| APH-UTWE 6-2 | | 3069057 | 10 |
| SF-SL 0,8X4,0-100 | | 1212551 | 10 |

| Lateral groove labeling |
|---|
| UC-TM 8, UCT-TM 8, ZB 8 or TMT (EX9,5)R (see Catalog 5) |

Test terminal strip, multi-position with PT ... push-in connection, for PTRE ... DIN rail mounting



6 (10) mm², 30 A, 4 ... 25-pos. test terminal strip, for DIN rail mounting

Notes:
 1) Derating curve available on request.
 2) Rated surge voltage of 5 kV.

Max. electrical data

| Rated data | |
|---|--------------------------|
| Rated voltage | [V] |
| Nominal current / cross section | [A] / [mm ²] |
| Rated cross section | [mm ²] |
| Cross section range | AWG |
| Connection capacity | |
| 1 conductor | [mm ²] |
| 2 stranded conductors with a TWIN ferrule | [mm ²] |
| Plug-in connection cross sections | [mm ²] |
| General data | |
| Stripping length | [mm] |
| Insulating material | |
| Inflammability class according to UL 94 | |

Technical data

| I _{max} [A] | U _{max} [V] | max. Ø [mm ²] | AWG |
|----------------------|----------------------|---------------------------|-----------------------------|
| 30 | 400 ²⁾ | 0.5 - 10 | 20 - 8 |
| IEC 60947-7-1 | | | |
| IEC | UL/CUL | CSA | IEC/EN 60079-7 |
| 400 ²⁾ | - | - | - |
| 24 ¹⁾ /6 | - | - | - |
| 6 | - | - | - |
| 20 - 8 | - | - | - |
| Connection capacity | | ferrule | |
| | solid | stranded | with/without plastic sleeve |
| 0.5 - 10 | | 0.5 - 6 | 0.5 - 6 |
| | | | 0.5 - 1.5 |
| 1 - 10 | - | 1 - 6 | 1 - 6 |
| PA | | | |
| V0 | | | |

| Description | No. of pos. | Color |
|--|-------------|-------|
| Test terminal strip, for DIN rail mounting, | | |
| 4-pos. | | gray |
| 5-pos. | | gray |
| 9-pos. | | gray |
| 10-pos. | | gray |
| 12-pos. | | gray |
| 14 pos. | | gray |
| 15-pos. | | gray |
| 17-pos. | | gray |
| 19 pos. | | gray |
| 20 pos. | | gray |
| 21 pos. | | gray |
| 22 pos. | | gray |
| 25 pos. | | gray |

Ordering data

| Type | I _{max} | Order No. | Pcs. / Pkt. |
|-------------|------------------|-----------|-------------|
| PTRE 6-2/4 | | 3069849 | 1 |
| PTRE 6-2/5 | | 3069850 | 1 |
| PTRE 6-2/9 | | 3069854 | 1 |
| PTRE 6-2/10 | | 3069855 | 1 |
| PTRE 6-2/12 | | 3069861 | 1 |
| PTRE 6-2/14 | | 3069863 | 1 |
| PTRE 6-2/15 | | 3069864 | 1 |
| PTRE 6-2/17 | | 3069866 | 1 |
| PTRE 6-2/19 | | 3069868 | 1 |
| PTRE 6-2/20 | | 3069869 | 1 |
| PTRE 6-2/21 | | 3069870 | 1 |
| PTRE 6-2/22 | | 3069871 | 1 |
| PTRE 6-2/25 | | 3069874 | 1 |

| Jumper | | |
|-------------------------------|--|-------------|
| | 2 | red |
| | 3 | red |
| | 4 | red |
| | 5 | red |
| | 6 | red |
| | 10 | red |
| Jumper | | |
| | 16 | red |
| Pre-assembled bridge, labeled | | |
| | 3-pos., positions 1, 3 | 3 red |
| | 4-pos., positions 1, 4 | 4 red |
| | 5-pos., positions 1, 3, 5 | 5 red |
| | 10-pos., positions 1, 4, 7, 10 | 10 red |
| | Cover profile, supply length 1 m | transparent |
| | End brackets, for AP-ME cover profile, sealable, with storage option for jumpers | gray |
| | Holder, for AP-ME cover profile | gray |
| Screwdriver | | |

Accessories

| Type | I _{max} | Order No. | Pcs. / Pkt. |
|-------------------|------------------|-----------|-------------|
| FBS 2-8 | 24 A | 3030284 | 10 |
| FBS 3-8 | 24 A | 3030297 | 10 |
| FBS 4-8 | 24 A | 3030307 | 10 |
| FBS 5-8 | 24 A | 3030310 | 10 |
| FBS 6-8 | 24 A | 3032470 | 10 |
| FBS 10-8 | 24 A | 3030323 | 10 |
| FBSR 16-8 | 24 A | 3033816 | 10 |
| FBS 1/3-8 | 24 A | 3032363 | 10 |
| FBS 1/4-8 | 24 A | 3032376 | 10 |
| FBS 1/3/5-8 | 24 A | 3032389 | 10 |
| FBS 1/4/7/10-8 | 24 A | 3032402 | 10 |
| AP-ME | METER | 3034361 | 10 |
| APH-ME | | 3034374 | 10 |
| APT-ME | | 3034358 | 10 |
| SF-SL 0,8X4,0-100 | | 1212551 | 10 |

Lateral groove labeling

UC-TM 8, UCT-TM 8, ZB 8 or TMT (EX9,5)R (see Catalog 5)

FAME plug-in test system

Test terminal strip, multi-position with UT ... screw connection, for UTWE ... wall mounting



The modular FAME measuring transducer test system, with universal screw connection technology, enables all transformer testing tasks to be carried out quickly and safely. The transformer is short-circuited and the testing device is looped in automatically through the insertion process.

- The test terminal strips can be used universally for current and voltage transducers
- The test terminal strip can be mounted on the control cabinet door or on the DIN rail
- Signal and status messages can be wired in combination in a test terminal strip
- The correct switching sequence when removing the test plug is ensured by a locking device and a mechanical drive in the twist grip
- All test signals can be connected with touch-proof safety test leads (CAT III and CAT IV/1000 V according to EN 61010-031)
- All versions listed can be equipped with coding for the matching test plug
- Star points of the current transformer can easily be created in the test terminal strip on the rear by means of FBS jumpers
- You can find corresponding accessories from page 99

| |
|---|
| Notes: |
| To create panel cutouts, see phoenixcontact.net/products. |
| 1) Derating curve available on request. |
| 2) Rated surge voltage of 5 kV. |



6 (10) mm², 30 A, 4 ... 25-pos. test terminal strip, for wall mounting

| | |
|---|--|
| Max. electrical data | |
| Rated data | |
| Rated voltage | [V] 400 ²⁾ |
| Nominal current / cross section | [A] / [mm ²] 24 ¹⁾ /6 |
| Rated cross section | [mm ²] 6 |
| Cross section range | AWG 24 - 8 |
| Connection capacity | |
| 1 conductor | [mm ²] 0.2 - 10 |
| 2 conductors (of the same type) | [mm ²] 0.2 - 2.5 |
| 2 stranded conductors with a TWIN ferrule | [mm ²] 0.2 - 2.5 |
| General data | |
| Stripping length | [mm] 10 |
| Screw thread | M4 |
| Tightening torque | [Nm] 1.5 - 1.8 |
| Tightening torque for wall fastening | [Nm] 0.8 - 1 |
| Panel thickness | [mm] 1 - 4 |
| Insulating material | PA |
| Inflammability class according to UL 94 | V0 |

| Technical data | | | |
|----------------------------|----------------------|-----------------------------|----------------|
| I _{max} [A] | U _{max} [V] | max. Ø [mm ²] | AWG |
| 30 | 400 ²⁾ | 0.2 - 10 | 24 - 8 |
| IEC 60947-7-1 | | | |
| IEC | UL/CUL | CSA | IEC/EN 60079-7 |
| Connection capacity | | ferrule | |
| solid | stranded | with/without plastic sleeve | |
| 0.2 - 10 | 0.2 - 10 | 0.25 - 6 | 0.25 - 6 |
| 0.2 - 2.5 | 0.2 - 2.5 | 0.25 - 1.5 | - |
| | | | 0.5 - 2.5 |

| Description | No. of pos. | Color |
|---|-------------|-------|
| Test terminal strip , for wall mounting, | | |
| 4-pos. | | gray |
| 5-pos. | | gray |
| 9-pos. | | gray |
| 10-pos. | | gray |
| 12-pos. | | gray |
| 14 pos. | | gray |
| 15-pos. | | gray |
| 17-pos. | | gray |
| 19 pos. | | gray |
| 20 pos. | | gray |
| 21 pos. | | gray |
| 22 pos. | | gray |
| 25 pos. | | gray |

| Ordering data | | | |
|---------------|------------------|-----------|-------------|
| Type | I _{max} | Order No. | Pcs. / Pkt. |
| UTWE 6-2/4 | | 3069650 | 1 |
| UTWE 6-2/5 | | 3069651 | 1 |
| UTWE 6-2/9 | | 3069656 | 1 |
| UTWE 6-2/10 | | 3069658 | 1 |
| UTWE 6-2/12 | | 3069660 | 1 |
| UTWE 6-2/14 | | 3069663 | 1 |
| UTWE 6-2/15 | | 3069664 | 1 |
| UTWE 6-2/17 | | 3069667 | 1 |
| UTWE 6-2/19 | | 3069672 | 1 |
| UTWE 6-2/20 | | 3069673 | 1 |
| UTWE 6-2/21 | | 3069800 | 1 |
| UTWE 6-2/22 | | 3069801 | 1 |
| UTWE 6-2/25 | | 3069804 | 1 |

| Jumper | No. of pos. | Color |
|--|-------------|-------------|
| | 2 | red |
| | 3 | red |
| | 4 | red |
| | 5 | red |
| | 6 | red |
| | 10 | red |
| Jumper | 16 | red |
| Pre-assembled bridge , labeled | | |
| 3-pos., positions 1, 3 | 3 | red |
| 4-pos., positions 1, 4 | 4 | red |
| 5-pos., positions 1, 3, 5 | 5 | red |
| 10-pos., positions 1, 4, 7, 10 | 10 | red |
| Cover profile , supply length 1 m | | transparent |
| Cover profile holder , can be snapped on and sealed | | gray |
| Screwdriver | | |

| Accessories | | | |
|-------------------|------------------|-----------|-------------|
| Type | I _{max} | Order No. | Pcs. / Pkt. |
| FBS 2-8 | 24 A | 3030284 | 10 |
| FBS 3-8 | 24 A | 3030297 | 10 |
| FBS 4-8 | 24 A | 3030307 | 10 |
| FBS 5-8 | 24 A | 3030310 | 10 |
| FBS 6-8 | 24 A | 3032470 | 10 |
| FBS 10-8 | 24 A | 3030323 | 10 |
| FBSR 16-8 | 24 A | 3033816 | 10 |
| FBS 1/3-8 | 24 A | 3032363 | 10 |
| FBS 1/4-8 | 24 A | 3032376 | 10 |
| FBS 1/3/5-8 | 24 A | 3032389 | 10 |
| FBS 1/4/7/10-8 | 24 A | 3032402 | 10 |
| AP RSC-T | | 3059139 | 10 |
| APH-UTWE 6-2 | | 3069057 | 10 |
| SF-SL 0,8X4,0-100 | | 1212551 | 10 |

| | |
|--------------------------------|---|
| Lateral groove labeling | UC-TM 8, UCT-TM 8, ZB 8 or TMT (EX9,5)R (see Catalog 5) |
|--------------------------------|---|

FAME plug-in test system

Test plug, multi-position, freely-configurable contact tabs FTPR ... and FTP ...



The test plugs allow the switching sequence of the individual functions to be carried out with safe chronological disconnection with a switching operation via three different contact tab lengths. Configure the lengths of the contact tabs of the test plug to suit your application. We can provide you with a test plug according to your requirements in next to no time.

- The test plugs can be easily configured and ordered with just a click of the mouse in the product area on our website at phoenixcontact.net/products
- To order via fax or e-mail, please use the ordering data as shown in the ordering example on the following page

- The test plugs are characterized by:
- User-friendly twist grip function with latching
 - Robust and warp resistant design
 - Mechanically secure, molded contact tabs
 - High-quality contact surfaces for reliable transmission of signals
 - Strain relief for the connected test leads on the plug
 - Flexibility in the number of positions thanks to the modular design (additional options on request)
 - Large-surface marking options for each contact
 - Use of CLIPLINE complete accessories for testing, bridging, and marking
 - Additional test leads, assembled with ring and fork-type cable lugs, can be attached with test sockets
 - All test signals can be connected with touch-proof safety test leads (CAT III and CAT IV/1000 V according to EN 61010-031)
 - You can find corresponding accessories from page 99

| |
|---------------------------------|
| Notes: |
| 1) Rated surge voltage of 5 kV. |



24 A, 4 ... 25-pos. test plug with twist grip or standard grip, 4 mm test sockets

| | |
|---|---------------------------------|
| Max. electrical data | |
| Rated data | |
| Rated voltage | [V] 400 ¹⁾ |
| Nominal current / cross section | [A] / [mm ²] 24/2.5 |
| Cross section range | AWG 20 - 14 |
| Connection capacity | |
| 1 conductor | [mm ²] - |
| General data | |
| Tightening torque: test socket screw | [Nm] 0.5 - 0.6 |
| Insulating material | PA |
| Inflammability class according to UL 94 | V0 |

| Technical data | | | |
|---|-------------------|---------------------------------------|----------------|
| I_{max} [A] | U_{max} [V] | max. \varnothing [mm ²] | AWG |
| 24 | 400 ¹⁾ | 0.5 - 2.5 | 20 - 14 |
| IEC | UL/CUL | CSA | IEC/EN 60079-7 |
| IEC | UL/CUL | CSA | IEC/EN 60079-7 |
| solid | stranded | ferrule with/without plastic sleeve | |
| 1 conductor | 0.5 - 2.5 | - | - |
| General data | | | |
| Tightening torque: test socket screw | [Nm] 0.5 - 0.6 | | |
| Insulating material | PA | | |
| Inflammability class according to UL 94 | V0 | | |

| Description | Color |
|--|-------|
| Test plug, with twist grip, 4-pos. | gray |
| 5-pos. | gray |
| 9-pos. | gray |
| 10-pos. | gray |
| 12-pos. | gray |
| 14 pos. | gray |
| 15-pos. | gray |
| 17-pos. | gray |
| 19 pos. | gray |
| 20 pos. | gray |
| 21 pos. | gray |
| 22 pos. | gray |
| 25 pos. | gray |
| Test plug, with standard grip, 4-pos. | gray |
| 5-pos. | gray |
| 9-pos. | gray |
| 10-pos. | gray |
| 12-pos. | gray |
| 14 pos. | gray |
| 15-pos. | gray |
| 17-pos. | gray |
| 19 pos. | gray |
| 20 pos. | gray |
| 21 pos. | gray |
| 22 pos. | gray |
| 25 pos. | gray |

| Ordering data | | | |
|---------------|-----------|-------------|--|
| Type | Order No. | Pcs. / Pkt. | |
| FTPR-2/4 | 3001681 | 1 | |
| FTPR-2/5 | 3001683 | 1 | |
| FTPR-2/9 | 3001687 | 1 | |
| FTPR-2/10 | 3001688 | 1 | |
| FTPR-2/12 | 3001690 | 1 | |
| FTPR-2/14 | 3001692 | 1 | |
| FTPR-2/15 | 3001693 | 1 | |
| FTPR-2/17 | 3001696 | 1 | |
| FTPR-2/19 | 3001698 | 1 | |
| FTPR-2/20 | 3001699 | 1 | |
| FTPR-2/21 | 3001700 | 1 | |
| FTPR-2/22 | 3001701 | 1 | |
| FTPR-2/25 | 3001704 | 1 | |
| FTP-2/4 | 3001706 | 1 | |
| FTP-2/5 | 3001707 | 1 | |
| FTP-2/9 | 3001711 | 1 | |
| FTP-2/10 | 3001712 | 1 | |
| FTP-2/12 | 3001714 | 1 | |
| FTP-2/14 | 3001716 | 1 | |
| FTP-2/15 | 3001717 | 1 | |
| FTP-2/17 | 3001720 | 1 | |
| FTP-2/19 | 3001723 | 1 | |
| FTP-2/20 | 3001724 | 1 | |
| FTP-2/21 | 3001725 | 1 | |
| FTP-2/22 | 3001726 | 1 | |
| FTP-2/25 | 3001729 | 1 | |

| | |
|--|------|
| Fork-type cable lug , insulated according to UL | red |
| | blue |
| Ring cable lug , insulated according to UL | red |
| | blue |

| Accessories | | |
|--------------|---------|-----|
| | | |
| C-FCI 1,5/M3 | 3240032 | 100 |
| C-FCI 2,5/M3 | 3240037 | 100 |
| C-RCI 1,5/M3 | 3240016 | 100 |
| C-RCI 2,5/M3 | 3240021 | 100 |

| | |
|----------------|---|
| Marking | UC-TM 8, UCT-TM 8, ZB 8 or TMT (EX9,5)R (see Catalog 5) |
|----------------|---|

Ordering example: configurable test plug with twist grip function

To ensure that your order is correct, you need a defined view of how everything is counted. This is achieved when the status window in the top view is on the left-hand side. Position 1 is then on the left.
 Each position of a test plug is described by a contact tab feature that is selected. The following features are possible:

- S** Short contact tab, gray
- M** Medium contact tab, gray
- L** Long contact tab, gray
- LGN** Long contact tab, green
- N** No contact tab, gray

Each position with a contact tab is supplied fitted with two gray test sockets.

Ordering example:
 A 15-pos. test plug with twist grip needs to be configured as follows:

- Pos. 1 Short contact tab, gray
- Pos. 2 Short contact tab, gray
- Pos. 3 Short contact tab, gray
- Pos. 4 Short contact tab, gray
- Pos. 5 Short contact tab, gray
- Pos. 6 Short contact tab, gray
- Pos. 7 Short contact tab, gray
- Pos. 8 No contact tab, gray
- Pos. 9 No contact tab, gray
- Pos. 10 Medium contact tab, gray
- Pos. 11 Medium contact tab, gray
- Pos. 12 Medium contact tab, gray
- Pos. 13 Medium contact tab, gray
- Pos. 14 Long contact tab, green
- Pos. 15 Long contact tab, green

The order data for this ordering example is therefore:

| Order No. | Pos. 1 | Pos. 2 | Pos. 3 | Pos. 4 | Pos. 5 | Pos. 6 | Pos. 7 | Pos. 8 | Pos. 9 | Pos. 10 | Pos. 11 | Pos. 12 | Pos. 13 | Pos. 14 | Pos. 15 |
|-----------|--------|--------|--------|--------|--------|--------|--------|--------|--------|---------|---------|---------|---------|---------|---------|
| 3001693 | /S | /S | /S | /S | /S | /S | /S | /N | /N | /M | /M | /M | /M | /LGN | /LGN |

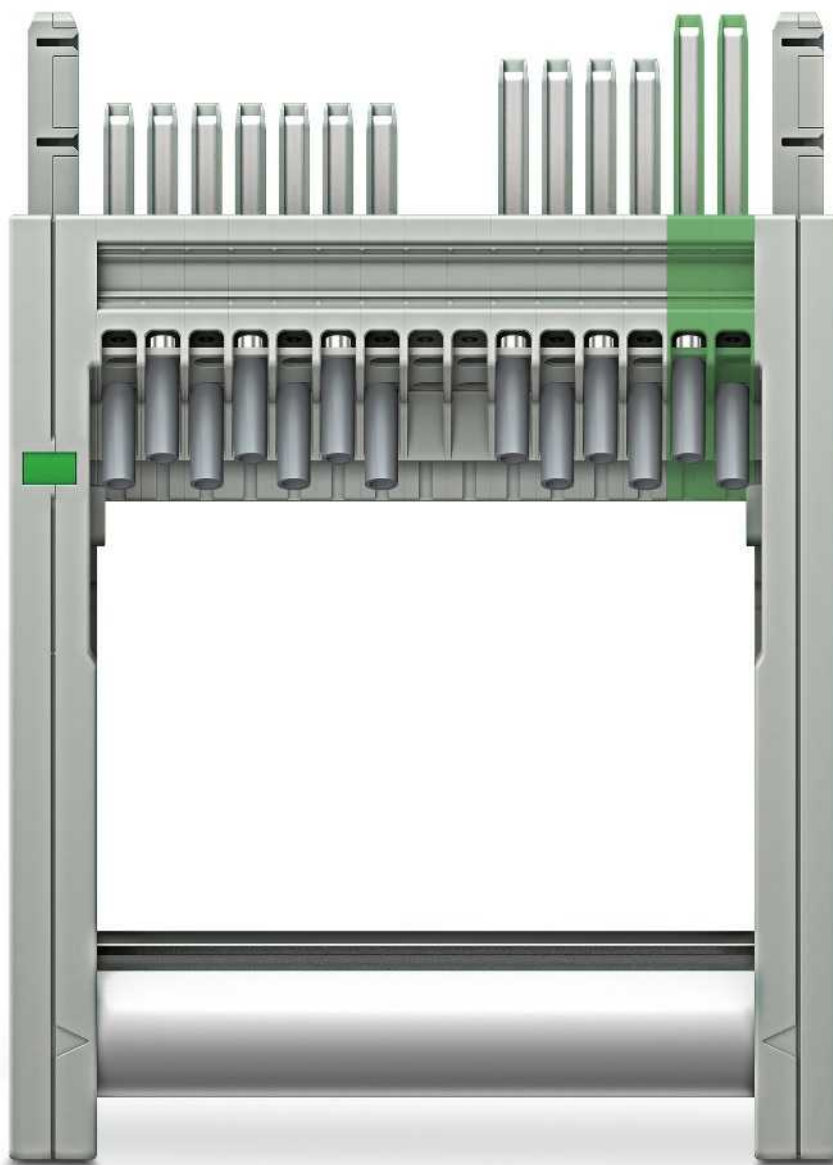

FAME plug-in test system

Blind plug, multi-position, sealable FBP-2/...

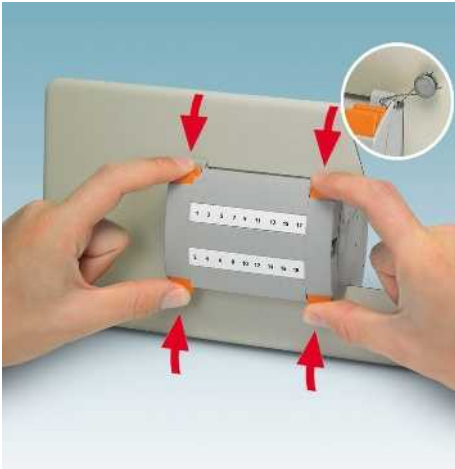

During normal operation, the blind plug acts as a protective cover for the test terminal strip and is characterized by:

- Secure latching on the test terminal strip
- The robust latching can only be released with two-hand operation
- The optional seal protects against unauthorized actuation
- Large-surface marking options
- The coding profile set can be used to assign test terminal strips and blind plugs according to the specific application, see right-hand page



Blind plug 4 ... 25-pos.

General data

Insulating material
Inflammability class according to UL 94

Technical data

PA
V0

Ordering data

| Description | Color |
|---------------------------|-------|
| Blind plug, 4-pos. | gray |
| 5-pos. | gray |
| 9-pos. | gray |
| 10-pos. | gray |
| 12-pos. | gray |
| 14 pos. | gray |
| 15-pos. | gray |
| 17-pos. | gray |
| 19 pos. | gray |
| 20 pos. | gray |
| 21 pos. | gray |
| 22 pos. | gray |
| 25 pos. | gray |

| Type | Order No. | Pcs. / Pkt. |
|-----------------|----------------|-------------|
| FBP-2/4 | 3069875 | 1 |
| FBP-2/5 | 3069876 | 1 |
| FBP-2/9 | 3069880 | 1 |
| FBP-2/10 | 3069881 | 1 |
| FBP-2/12 | 3069883 | 1 |
| FBP-2/14 | 3069885 | 1 |
| FBP-2/15 | 3069886 | 1 |
| FBP-2/17 | 3069888 | 1 |
| FBP-2/19 | 3069890 | 1 |
| FBP-2/20 | 3069891 | 1 |
| FBP-2/21 | 3069892 | 1 |
| FBP-2/22 | 3069893 | 1 |
| FBP-2/25 | 3069896 | 1 |

Lateral groove labeling

Accessories

UC-TM 8, UCT-TM 8, ZB 8 or TMT (EX9,5)R
(see Catalog 5)

PC-...-TRI coding profile set



- The coding profile set can be used to assign test terminal strips and test plugs according to the specific application
- Maximum safety is therefore ensured for all testing tasks



General data

Material
Inflammability class according to UL 94

Technical data

PA
V0

Ordering data

| Description | Color |
|---|-------|
| Coding profile set, for the test terminal strip | red |
| Coding profile set, for FTP-2 and FTPR-2 test plugs and FBP-2 blind plugs | red |

| Type | Order No. | Pcs. / Pkt. |
|-------------|-----------|-------------|
| PC-UTWE-TRI | 3069897 | 50 |
| PC-FTP-TRI | 3069898 | 50 |

Colored PSBJ ... test sockets

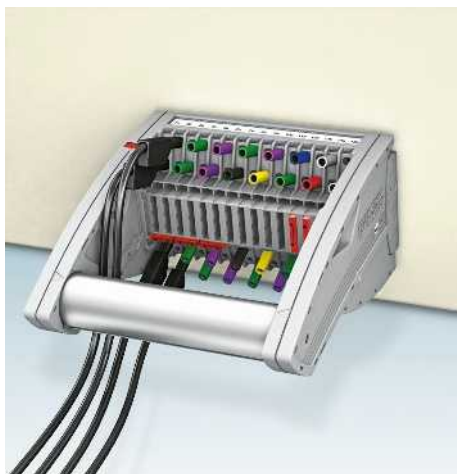

- 4 mm safety test leads with fixed insulation according to EN 61010-031 CAT III and CAT IV up to 1000 V can be coded in true color
- Additional test leads, assembled with ring and fork-type cable lugs (see accessories, e.g., page 96) can be attached with test sockets



Ordering data

| Description | Color |
|------------------------|-------------|
| Test socket, insulated | transparent |
| | red |
| | blue |
| | yellow |
| | green |
| | violet |
| | black |
| | gray |
| | brown |

| Type | Order No. | Pcs. / Pkt. |
|---------------------|-----------|-------------|
| PSBJ-URTK 6 FARBLOS | 3026450 | 10 |
| PSBJ-URTK 6 RD | 3026719 | 10 |
| PSBJ-URTK 6 BU | 3026434 | 10 |
| PSBJ-URTK 6 YE | 3026405 | 10 |
| PSBJ-URTK 6 GN | 3026418 | 10 |
| PSBJ-URTK 6 VT | 3026421 | 10 |
| PSBJ-URTK 6 BK | 3026447 | 10 |
| PSBJ-URTK 6 GY | 3026612 | 10 |
| PSBJ-URTK 6 BN | 3026971 | 10 |

Modular terminal blocks

FAME plug-in test system

Jumper, red, 8.2 mm pitch, FBS ...

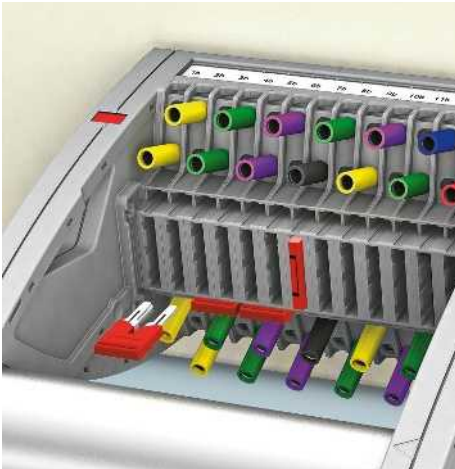

– The FBS ...-8 plug-in bridges are used for short-circuiting, as star-point jumpers, and also to establish grounding in connection with a PE modular terminal block on the terminal strip



| | | Ordering data | | | |
|---------------|-------------|---------------|------------------|-----------|-------------|
| Description | No. of pos. | Type | I _{max} | Order No. | Pcs. / Pkt. |
| Jumper | 2 | FBS 2-8 | 41 A | 3030284 | 10 |
| | 3 | FBS 3-8 | | 3030297 | 10 |
| | 4 | FBS 4-8 | | 3030307 | 10 |
| | 5 | FBS 5-8 | | 3030310 | 10 |
| | 6 | FBS 6-8 | | 3032470 | 10 |
| | 10 | FBS 10-8 | | 3030323 | 10 |
| Jumper | 16 | FBSR 16-8 | 32 A | 3033816 | 10 |

Jumper with extraction tool, red, 8.2 mm pitch, FBSRH ...

– The FBSRH ...-8 bridges have a molded extraction tool which means that they can be used conveniently and without tools for individual bridging tasks. This enables a transformer short circuit to be created in test disconnect terminal blocks, for example.



| | | Ordering data | | | |
|-------------------------------------|-------------|---------------|------------------|-----------|-------------|
| Description | No. of pos. | Type | I _{max} | Order No. | Pcs. / Pkt. |
| Jumper, with extraction tool | 2 | FBSRH 2-8 | 32 A | 3033802 | 10 |
| | 3 | FBSRH 3-8 | | 3033803 | 10 |
| | 4 | FBSRH 4-8 | | 3033804 | 10 |

Pre-assembled bridge, red, 8.2 mm pitch

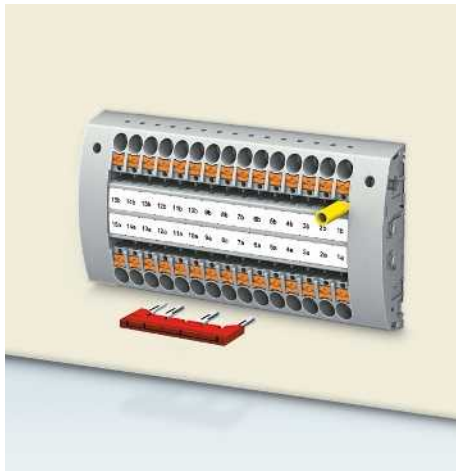

- Plug-in star-point jumpers or jumpers for bridging several positions can be supplied pre-configured without additional expense
- The bridges are printed and provide unique identification for bridging between non-adjacent terminal blocks



| Description | | Ordering data | | Ordering data | |
|--------------------------------------|-------------|-----------------------|------------------|----------------|-------------|
| Description | No. of pos. | Type | I _{max} | Order No. | Pcs. / Pkt. |
| Pre-assembled bridge, labeled | | | | | |
| 3-pos., positions 1, 3 | 3 | FBS 1/3-8 | 41 A | 3032363 | 10 |
| 4-pos., positions 1, 4 | 4 | FBS 1/4-8 | | 3032376 | 10 |
| 5-pos., positions 1, 3, 5 | 5 | FBS 1/3/5-8 | | 3032389 | 10 |
| 10-pos., positions 1, 4, 7, 10 | 10 | FBS 1/4/7/10-8 | | 3032402 | 10 |

Cover profiles for test plug or test terminal strip mounted on DIN rail



- The AP-FTP cover profile prevents undesired changes to the star point, feed-through, and short-circuit jumpers on the completely assembled test plug
- To mount, gently release the side screw connection of the plug and snap the profile into place
- The APH-ME end bracket is used in conjunction with the AP-ME cover for the DIN rail mounted test terminal strip



| General data | | Technical data | | Ordering data | |
|--|-------------|---------------------|----------------|---------------|--|
| Material | | PVC | | Ordering data | |
| Description | Color | Type | Order No. | Pcs. / Pkt. | |
| Cover profile , supply length 1 m | transparent | AP-FTP METER | 3069899 | 1 | |
| Cover profile , supply length 1 m | transparent | AP-ME METER | 3034361 | 10 | |
| Cover profile , supply length 1 m | transparent | AP RSC-T | 3059139 | 10 | |
| End brackets , for AP-ME cover profile, sealable, with storage option for jumpers | gray | APH-ME | 3034374 | 10 | |
| Cover profile holder , can be snapped on and sealed | gray | APH-UTWE 6-2 | 3069057 | 10 | |

FAME plug-in test system

Test terminal strip with PT ... push-in connection, VDE type A7, for wall and DIN rail mounting

The **VDE A7** version described here is suitable as a plug-in test system in single-system current, voltage, and power relays, wattmetric and ground fault wiper relays, detuning level controllers or reverse power protection for generators.

- The test plugs are assembled with jumpers and contact tab lengths according to the circuit diagram
- A transparent covering hood protects the jumpers. The covering hood can only be removed by dismantling the test plug
- All VDE-specified 7, 14, and 19-pos. versions are supplied with exclusive coding for the matching test plug and blind plug
- The components are supplied pre-marked according to the VDE Directive
- Test signals can be connected with touch-proof safety test leads (CAT III and IV/1000 V according to EN 61010-031)
- The test plugs are equipped with two gray test sockets per position, for further color versions, see the range of accessories
- Additional test leads, assembled with ring and fork-type cable lugs, can be attached with test sockets
- Other VDE versions available on request

| Notes: |
|---|
| To create panel cutouts, see phoenixcontact.net/products . |
| 1) Derating curve available on request. |
| 2) Rated surge voltage of 5 kV. |

Long contacts
Short contacts

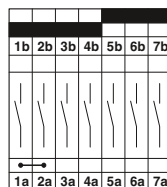

A7



6 (10) mm², 30 A, test terminal strip, for wall mounting, VDE coded type A7

| Max. electrical data | |
|---|--|
| Rated data | |
| Rated voltage | [V] 400 ²⁾ |
| Nominal current / cross section | [A] / [mm ²] 24 ¹⁾ /6 |
| Rated cross section | [mm ²] 6 |
| Cross section range | AWG 20 - 8 |
| Connection capacity | |
| 1 conductor | [mm ²] 0.5 - 10 |
| 2 stranded conductors with a TWIN ferrule | [mm ²] 0.5 - 6 |
| Plug-in connection cross sections | [mm ²] 1 - 10 |
| General data | |
| Stripping length | [mm] 12 |
| Tightening torque for wall fastening | [Nm] 0.8 - 1 |
| Panel thickness | [mm] 1 - 4 |
| Tightening torque: test socket screw | [Nm] - |
| Insulating material | PA |
| Inflammability class according to UL 94 | V0 |

| Technical data | | | |
|----------------------------|-------------------|-----------------------------|----------------|
| I_{max} [A] | U_{max} [V] | max. Ø [mm ²] | AWG |
| 30 | 400 ²⁾ | 0.5 - 10 | 20 - 8 |
| IEC 60947-7-1 | | | |
| IEC | UL/CUL | CSA | IEC/EN 60079-7 |
| Connection capacity | | | |
| solid | | stranded | |
| 0.5 - 10 | | 0.5 - 6 | |
| | | ferrule | |
| | | with/without plastic sleeve | |
| | | 0.5 - 6 | |
| | | 0.5 - 1.5 | |
| 1 - 10 | | 1 - 6 | |
| | | 1 - 6 | |

| Description | Color |
|---|-------|
| Test terminal strip, for wall mounting | gray |
| Test terminal strip, for mounting on NS 35... | gray |
| Test plug, with twist grip | gray |
| With standard handle | gray |
| Test plug, 1-pos., with cover | gray |
| Blind plug, sealable | gray |

| Ordering data | | |
|---------------|-----------|-------------|
| Type | Order No. | Pcs. / Pkt. |
| PTWE 6-2/A7 | 3069436 | 1 |

| | |
|--|---|
| Test socket, insulated | transparent |
| | red |
| | blue |
| | yellow |
| | green |
| | violet |
| | black |
| | gray |
| | brown |
| Cover profile, supply length 1 m | transparent |
| Cover profile holder, can be snapped on and sealed | gray |
| Cover profile, supply length 1 m | transparent |
| End brackets, for AP-ME cover profile, sealable, with storage option for jumpers | gray |
| Holder, for AP-ME cover profile | gray |
| Fork-type cable lug, insulated according to UL | red |
| | blue |
| Ring cable lug, insulated according to UL | red |
| | blue |
| Screwdriver | SF-SL 0,8X4,0-100 |
| Lateral groove labeling | UC-TM 8, UCT-TM 8, ZB 8 or TMT (EX9,5)R (see Catalog 5) |

| Accessories | | |
|---|---------|----|
| AP RSC-T | 3059139 | 10 |
| APH-UTWE 6-2 | 3069057 | 10 |
| SF-SL 0,8X4,0-100 | 1212551 | 10 |
| UC-TM 8, UCT-TM 8, ZB 8 or TMT (EX9,5)R (see Catalog 5) | | |



6 (10) mm², 30 A, test terminal strip, for DIN rail mounting, VDE coded type A7



24 A, test plug, bridge assignment according to circuit diagram, VDE coded type A7



Blind plug, VDE coded type A7

| Technical data | | | |
|----------------------|----------------------|-------------------------------------|----------------------|
| I _{max} [A] | U _{max} [V] | max. Ø [mm ²] | AWG |
| 30 | 400 ²⁾ | 0.5 - 10 | 20 - 8 |
| IEC 60947-7-1 | | | |
| IEC | UL/CUL | CSA | IEC/EN 60079-7 |
| 400 ²⁾ | - | - | - |
| 24 ¹⁾ /6 | - | - | - |
| 6 | - | - | - |
| 20 - 8 | - | - | - |
| solid | stranded | ferrule with/without plastic sleeve | |
| 0.5 - 10 | 0.5 - 6 | 0.5 - 6 | 0.5 - 6 0.5 - 1.5 |
| 1 - 10 | - | 1 - 6 | 1 - 6 |
| 12 | - | - | - |
| - | - | - | - |
| - | - | - | - |
| - | - | - | - |
| PA | - | - | - |
| V0 | - | - | - |

| Technical data | | | |
|----------------------|----------------------|-------------------------------------|---------|
| I _{max} [A] | U _{max} [V] | max. Ø [mm ²] | AWG |
| 24 | 400 ²⁾ | 0.5 - 2.5 | 20 - 14 |
| IEC | | | |
| UL/CUL | CSA | IEC/EN 60079-7 | |
| 400 ²⁾ | - | - | - |
| 24/2.5 | - | - | - |
| 6 | - | - | - |
| 20 - 14 | - | - | - |
| solid | stranded | ferrule with/without plastic sleeve | |
| - | 0.5 - 2.5 | - | - |
| - | - | - | - |
| - | - | - | - |
| 0.5 - 0.6 | - | - | - |
| PA | - | - | - |
| V0 | - | - | - |

| Technical data | | | |
|----------------|----------|-------------------------------------|-----|
| | | max. Ø [mm ²] | AWG |
| | | - | - |
| IEC | | | |
| UL/CUL | CSA | IEC/EN 60079-7 | |
| - | - | - | - |
| - | - | - | - |
| - | - | - | - |
| - | - | - | - |
| solid | stranded | ferrule with/without plastic sleeve | |
| - | - | - | - |
| - | - | - | - |
| - | - | - | - |
| PA | - | - | - |
| V0 | - | - | - |

| Ordering data | | |
|---------------|-----------|-------------|
| Type | Order No. | Pcs. / Pkt. |
| PTRE 6-2/A7 | 3069449 | 1 |
| FTPR-2/A7 | 3069484 | 1 |
| FTP-2/A7 | 3069470 | 1 |
| FTP-2/1 | 3069469 | 1 |

| Ordering data | | |
|---------------|-----------|-------------|
| Type | Order No. | Pcs. / Pkt. |
| FBP-2/A7 | 3069497 | 1 |

| Ordering data | | |
|---------------|-----------|-------------|
| Type | Order No. | Pcs. / Pkt. |
| FBP-2/A7 | 3069497 | 1 |

| Accessories | | | |
|-------------------|-------|---------|----|
| AP-ME | METER | 3034361 | 10 |
| APH-ME | | 3034374 | 10 |
| APT-ME | | 3034358 | 10 |
| SF-SL 0,8X4,0-100 | | 1212551 | 10 |

| Accessories | | | |
|---------------------|--|---------|-----|
| PSBJ-URTK 6 FARBLOS | | 3026450 | 10 |
| PSBJ-URTK 6 RD | | 3026719 | 10 |
| PSBJ-URTK 6 BU | | 3026434 | 10 |
| PSBJ-URTK 6 YE | | 3026405 | 10 |
| PSBJ-URTK 6 GN | | 3026418 | 10 |
| PSBJ-URTK 6 VT | | 3026421 | 10 |
| PSBJ-URTK 6 BK | | 3026447 | 10 |
| PSBJ-URTK 6 GY | | 3026612 | 10 |
| PSBJ-URTK 6 BN | | 3026971 | 10 |
| C-FCI 1,5/M3 | | 3240032 | 100 |
| C-FCI 2,5/M3 | | 3240037 | 100 |
| C-RCI 1,5/M3 | | 3240016 | 100 |
| C-RCI 2,5/M3 | | 3240021 | 100 |

| Accessories | | | |
|---|--|--|--|
| UC-TM 8, UCT-TM 8, ZB 8 or TMT (EX9,5)R | | | |

UC-TM 8, UCT-TM 8, ZB 8 or TMT (EX9,5)R (see Catalog 5)

UC-TM 8, UCT-TM 8, ZB 8 or TMT (EX9,5)R (see Catalog 5)

UC-TM 8, UCT-TM 8, ZB 8 or TMT (EX9,5)R (see Catalog 5)

FAME plug-in test system

Test terminal strip with PT ... push-in connection, VDE type B7, for wall and DIN rail mounting

The **VDE B7** version described here is suitable as a plug-in test system in digital differential protection as an addition to the F19 plug-in test system, see page 120.

- The test plugs are assembled with jumpers and contact tab lengths according to the circuit diagram
- A transparent covering hood protects the jumpers. The covering hood can only be removed by dismantling the test plug
- All VDE-specified 7, 14, and 19-pos. versions are supplied with exclusive coding for the matching test plug and blind plug
- The components are supplied pre-marked according to the VDE Directive
- Test signals can be connected with touch-proof safety test leads (CAT III and IV/1000 V according to EN 61010-031)
- The test plugs are equipped with two gray test sockets per position, for further color versions, see the range of accessories
- Additional test leads, assembled with ring and fork-type cable lugs, can be attached with test sockets
- Other VDE versions available on request

Notes:

To create panel cutouts, see phoenixcontact.net/products.

¹⁾ Derating curve available on request.

²⁾ Rated surge voltage of 5 kV.

Long contacts
Short contacts

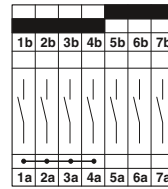

B7



6 (10) mm², 30 A, test terminal strip, for wall mounting, VDE coded type B7

Max. electrical data

30

Rated data

| | | |
|---------------------------------|--------------------------|---------------------|
| Rated voltage | [V] | 400 ²⁾ |
| Nominal current / cross section | [A] / [mm ²] | 24 ¹⁾ /6 |
| Rated cross section | [mm ²] | 6 |
| Cross section range | AWG | 20 - 8 |

Connection capacity

| | | |
|---|--------------------|----------|
| 1 conductor | [mm ²] | 0.5 - 10 |
| 2 stranded conductors with a TWIN ferrule | [mm ²] | 0.5 - 6 |
| Plug-in connection cross sections | [mm ²] | 1 - 10 |

General data

| | | |
|---|------|---------|
| Stripping length | [mm] | 12 |
| Tightening torque for wall fastening | [Nm] | 0.8 - 1 |
| Panel thickness | [mm] | 1 - 4 |
| Tightening torque: test socket screw | [Nm] | - |
| Insulating material | | PA |
| Inflammability class according to UL 94 | | V0 |

Technical data

| I _{max} [A] | U _{max} [V] | max. Ø [mm ²] | AWG |
|-----------------------------|-------------------------|---------------------------|----------------|
| 30 | 400²⁾ | 0.5 - 10 | 20 - 8 |
| IEC 60947-7-1 | | | |
| IEC | UL/CUL | CSA | IEC/EN 60079-7 |
| solid | | | |
| stranded | | | |
| ferrule | | | |
| with/without plastic sleeve | | | |
| 0.5 - 10 | 0.5 - 6 | 0.5 - 6 | 0.5 - 6 |
| 1 - 10 | - | 1 - 6 | 0.5 - 1.5 |
| 1 - 10 | - | 1 - 6 | 1 - 6 |

Ordering data

| Type | Order No. | Pcs. / Pkt. |
|--------------------|----------------|-------------|
| PTWE 6-2/B7 | 3069437 | 1 |

Accessories

| Description | Color | Type | Order No. | Pcs. / Pkt. |
|--|---|--|----------------|-------------|
| Test terminal strip , for wall mounting | gray | PTWE 6-2/B7 | 3069437 | 1 |
| Test terminal strip , for mounting on NS 35... | gray | | | |
| Test plug , with twist grip | gray | | | |
| With standard handle | gray | | | |
| Test plug , 1-pos., with cover | gray | | | |
| Blind plug , sealable | gray | | | |
| Test socket , insulated | transparent red blue yellow green violet black gray brown | | | |
| Cover profile , supply length 1 m | transparent | AP RSC-T | 3059139 | 10 |
| Cover profile holder , can be snapped on and sealed | gray | APH-UTWE 6-2 | 3069057 | 10 |
| Cover profile , supply length 1 m | transparent | | | |
| End brackets , for AP-ME cover profile, sealable, with storage option for jumpers | gray | | | |
| Holder , for AP-ME cover profile | gray | | | |
| Fork-type cable lug , insulated according to UL | red blue | | | |
| Ring cable lug , insulated according to UL | red blue | | | |
| Screwdriver | | SF-SL 0,8X4,0-100 | 1212551 | 10 |
| Lateral groove labeling | | UC-TM 8, UCT-TM 8, ZB 8 or TMT (EX9,5)R (see Catalog 5) | | |



6 (10) mm², 30 A, test terminal strip, for DIN rail mounting, VDE coded type B7



24 A, test plug, bridge assignment according to circuit diagram, VDE coded type B7



Blind plug, VDE coded type B7

| Technical data | | | |
|----------------------|----------------------|-------------------------------------|----------------------|
| I _{max} [A] | U _{max} [V] | max. Ø [mm ²] | AWG |
| 30 | 400 ²⁾ | 0.5 - 10 | 20 - 8 |
| IEC 60947-7-1 | | | |
| IEC | UL/CUL | CSA | IEC/EN 60079-7 |
| 400 ²⁾ | - | - | - |
| 24 ¹⁾ /6 | - | - | - |
| 6 | - | - | - |
| 20 - 8 | - | - | - |
| solid | stranded | ferrule with/without plastic sleeve | |
| 0.5 - 10 | 0.5 - 6 | 0.5 - 6 | 0.5 - 6 0.5 - 1.5 |
| 1 - 10 | - | 1 - 6 | 1 - 6 |
| 12 | - | - | - |
| - | - | - | - |
| - | - | - | - |
| - | - | - | - |
| PA | - | - | - |
| V0 | - | - | - |

| Technical data | | | |
|----------------------|----------------------|-------------------------------------|---------|
| I _{max} [A] | U _{max} [V] | max. Ø [mm ²] | AWG |
| 24 | 400 ²⁾ | 0.5 - 2.5 | 20 - 14 |
| IEC | | | |
| UL/CUL | CSA | IEC/EN 60079-7 | |
| 400 ²⁾ | - | - | - |
| 24/2.5 | - | - | - |
| 6 | - | - | - |
| 20 - 14 | - | - | - |
| solid | stranded | ferrule with/without plastic sleeve | |
| - | 0.5 - 2.5 | - | - |
| - | - | - | - |
| - | - | - | - |
| 0.5 - 0.6 | - | - | - |
| PA | - | - | - |
| V0 | - | - | - |

| Technical data | | | |
|----------------|----------|-------------------------------------|-----|
| | | max. Ø [mm ²] | AWG |
| - | - | - | - |
| IEC | | | |
| UL/CUL | CSA | IEC/EN 60079-7 | |
| - | - | - | - |
| - | - | - | - |
| - | - | - | - |
| - | - | - | - |
| solid | stranded | ferrule with/without plastic sleeve | |
| - | - | - | - |
| - | - | - | - |
| - | - | - | - |
| PA | - | - | - |
| V0 | - | - | - |

| Ordering data | | |
|---------------|-----------|-------------|
| Type | Order No. | Pcs. / Pkt. |
| PTRE 6-2/B7 | 3069450 | 1 |

| Ordering data | | |
|---------------|-----------|-------------|
| Type | Order No. | Pcs. / Pkt. |
| FTPR-2/B7 | 3069485 | 1 |
| FTP-2/B7 | 3069471 | 1 |
| FTP-2/1 | 3069469 | 1 |

| Ordering data | | |
|---------------|-----------|-------------|
| Type | Order No. | Pcs. / Pkt. |
| FBP-2/B7 | 3069498 | 1 |

| Accessories | | | |
|-------------------|-------|---------|----|
| AP-ME | METER | 3034361 | 10 |
| APH-ME | | 3034374 | 10 |
| APT-ME | | 3034358 | 10 |
| SF-SL 0,8X4,0-100 | | 1212551 | 10 |

| Accessories | | | |
|---------------------|--|---------|-----|
| PSBJ-URTK 6 FARBLOS | | 3026450 | 10 |
| PSBJ-URTK 6 RD | | 3026719 | 10 |
| PSBJ-URTK 6 BU | | 3026434 | 10 |
| PSBJ-URTK 6 YE | | 3026405 | 10 |
| PSBJ-URTK 6 GN | | 3026418 | 10 |
| PSBJ-URTK 6 VT | | 3026421 | 10 |
| PSBJ-URTK 6 BK | | 3026447 | 10 |
| PSBJ-URTK 6 GY | | 3026612 | 10 |
| PSBJ-URTK 6 BN | | 3026971 | 10 |
| C-FCI 1,5/M3 | | 3240032 | 100 |
| C-FCI 2,5/M3 | | 3240037 | 100 |
| C-RCI 1,5/M3 | | 3240016 | 100 |
| C-RCI 2,5/M3 | | 3240021 | 100 |

| Accessories | | | |
|---|--|--|--|
| UC-TM 8, UCT-TM 8, ZB 8 or TMT (EX9,5)R | | | |

UC-TM 8, UCT-TM 8, ZB 8 or TMT (EX9,5)R (see Catalog 5)

UC-TM 8, UCT-TM 8, ZB 8 or TMT (EX9,5)R (see Catalog 5)

UC-TM 8, UCT-TM 8, ZB 8 or TMT (EX9,5)R (see Catalog 5)

FAME plug-in test system

Test terminal strip with PT ... push-in connection, VDE type E7, for wall and DIN rail mounting

The **VDE E7** version described here is suitable as a plug-in test system for single-stage automatic frequency load shedding (AFLS) and as rotor ground fault protection.

- The test plugs are assembled according to the circuit diagram
- A transparent covering hood protects the jumpers. The covering hood can only be removed by dismantling the test plug
- All VDE-specified 7, 14, and 19-pos. versions are supplied with exclusive coding for the matching test plug and blind plug
- The components are supplied pre-marked according to the VDE Directive
- Test signals can be connected with touch-proof safety test leads (CAT III and IV/1000 V according to EN 61010-031)
- The test plugs are equipped with two gray test sockets per position, for further color versions, see the range of accessories
- Additional test leads, assembled with ring and fork-type cable lugs, can be attached with test sockets
- Other VDE versions available on request

| Notes: | |
|---|--|
| To create panel cutouts, see phoenixcontact.net/products . | |
| 1) Derating curve available on request. | |
| 2) Rated surge voltage of 5 kV. | |

Long contacts
Short contacts

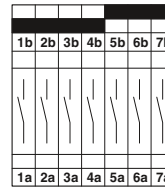

E7



6 (10) mm², 30 A, test terminal strip, for wall mounting, VDE coded type E7

| Max. electrical data | |
|---|--|
| Rated data | |
| Rated voltage | [V] 400 ²⁾ |
| Nominal current / cross section | [A] / [mm ²] 24 ¹⁾ /6 |
| Rated cross section | [mm ²] 6 |
| Cross section range | AWG 20 - 8 |
| Connection capacity | |
| 1 conductor | [mm ²] 0.5 - 10 |
| 2 stranded conductors with a TWIN ferrule | [mm ²] 0.5 - 6 |
| Plug-in connection cross sections | [mm ²] 1 - 10 |
| General data | |
| Stripping length | [mm] 12 |
| Tightening torque for wall fastening | [Nm] 0.8 - 1 |
| Panel thickness | [mm] 1 - 4 |
| Tightening torque: test socket screw | [Nm] - |
| Insulating material | PA |
| Inflammability class according to UL 94 | V0 |

| Technical data | | | |
|---------------------|-------------------|-----------------------------|----------------|
| I_{max} [A] | U_{max} [V] | max. Ø [mm ²] | AWG |
| 30 | 400 ²⁾ | 0.5 - 10 | 20 - 8 |
| IEC 60947-7-1 | | | |
| IEC | UL/CUL | CSA | IEC/EN 60079-7 |
| Connection capacity | | ferrule | |
| solid | stranded | with/without plastic sleeve | |
| 0.5 - 10 | 0.5 - 6 | 0.5 - 6 | 0.5 - 6 |
| | | 1 - 4 | 0.5 - 1.5 |
| 1 - 10 | - | 1 - 6 | 1 - 6 |

| Description | Color |
|---|-------|
| Test terminal strip, for wall mounting | gray |
| Test terminal strip, for mounting on NS 35... | gray |
| Test plug, with twist grip | gray |
| With standard handle | gray |
| Test plug, 1-pos., with cover | gray |
| Blind plug, sealable | gray |

| | |
|--|---|
| Test socket, insulated | transparent |
| | red |
| | blue |
| | yellow |
| | green |
| | violet |
| | black |
| | gray |
| | brown |
| Cover profile, supply length 1 m | transparent |
| Cover profile holder, can be snapped on and sealed | gray |
| Cover profile, supply length 1 m | transparent |
| End brackets, for AP-ME cover profile, sealable, with storage option for jumpers | gray |
| Holder, for AP-ME cover profile | gray |
| Fork-type cable lug, insulated according to UL | red |
| | blue |
| Ring cable lug, insulated according to UL | red |
| | blue |
| Screwdriver | SF-SL 0,8X4,0-100 |
| Lateral groove labeling | UC-TM 8, UCT-TM 8, ZB 8 or TMT (EX9,5)R (see Catalog 5) |

| Ordering data | | |
|---------------|-----------|-------------|
| Type | Order No. | Pcs. / Pkt. |
| PTWE 6-2/E7 | 3069438 | 1 |

| Accessories | | |
|---|---------|----|
| AP RSC-T | 3059139 | 10 |
| APH-UTWE 6-2 | 3069057 | 10 |
| SF-SL 0,8X4,0-100 | 1212551 | 10 |
| UC-TM 8, UCT-TM 8, ZB 8 or TMT (EX9,5)R (see Catalog 5) | | |



6 (10) mm², 30 A, test terminal strip, for DIN rail mounting, VDE coded type E7



24 A, test plug, bridge assignment according to circuit diagram, VDE coded type E7



Blind plug, VDE coded type E7

| Technical data | | | |
|----------------------|----------------------|-------------------------------------|----------------------|
| I _{max} [A] | U _{max} [V] | max. Ø [mm ²] | AWG |
| 30 | 400 ²) | 0.5 - 10 | 20 - 8 |
| IEC 60947-7-1 | | | |
| IEC | UL/CUL | CSA | IEC/EN 60079-7 |
| 400 ²) | - | - | - |
| 24 ¹)/6 | - | - | - |
| 6 | - | - | - |
| 20 - 8 | - | - | - |
| solid | stranded | ferrule with/without plastic sleeve | |
| 0.5 - 10 | 0.5 - 6 | 0.5 - 6 | 0.5 - 6 0.5 - 1.5 |
| 1 - 10 | - | 1 - 6 | 1 - 6 |
| 12 | - | - | - |
| - | - | - | - |
| - | - | - | - |
| - | - | - | - |
| PA | - | - | - |
| V0 | - | - | - |

| Technical data | | | |
|----------------------|----------------------|-------------------------------------|---------|
| I _{max} [A] | U _{max} [V] | max. Ø [mm ²] | AWG |
| 24 | 400 ²) | 0.5 - 2.5 | 20 - 14 |
| IEC | | | |
| UL/CUL | CSA | IEC/EN 60079-7 | |
| 400 ²) | - | - | - |
| 24/2.5 | - | - | - |
| 6 | - | - | - |
| 20 - 14 | - | - | - |
| solid | stranded | ferrule with/without plastic sleeve | |
| - | 0.5 - 2.5 | - | - |
| - | - | - | - |
| - | - | - | - |
| 0.5 - 0.6 | - | - | - |
| PA | - | - | - |
| V0 | - | - | - |

| Technical data | | | |
|----------------|----------|-------------------------------------|-----|
| | | max. Ø [mm ²] | AWG |
| | | - | - |
| IEC | | | |
| UL/CUL | CSA | IEC/EN 60079-7 | |
| - | - | - | - |
| - | - | - | - |
| - | - | - | - |
| - | - | - | - |
| solid | stranded | ferrule with/without plastic sleeve | |
| - | - | - | - |
| - | - | - | - |
| - | - | - | - |
| PA | - | - | - |
| V0 | - | - | - |

| Ordering data | | |
|---------------|-----------|-------------|
| Type | Order No. | Pcs. / Pkt. |
| PTRE 6-2/E7 | 3069451 | 1 |
| FTPR-2/E7 | 3069486 | 1 |
| FTP-2/E7 | 3069472 | 1 |
| FTP-2/1 | 3069469 | 1 |
| FBP-2/E7 | 3069499 | 1 |

| Ordering data | | |
|---------------|-----------|-------------|
| Type | Order No. | Pcs. / Pkt. |
| FTPR-2/E7 | 3069486 | 1 |
| FTP-2/E7 | 3069472 | 1 |
| FTP-2/1 | 3069469 | 1 |

| Ordering data | | |
|---------------|-----------|-------------|
| Type | Order No. | Pcs. / Pkt. |
| FBP-2/E7 | 3069499 | 1 |

| Accessories | | | |
|-------------------|-------|---------|----|
| AP-ME | METER | 3034361 | 10 |
| APH-ME | | 3034374 | 10 |
| APT-ME | | 3034358 | 10 |
| SF-SL 0,8X4,0-100 | | 1212551 | 10 |

| Accessories | | | |
|---------------------|--|---------|-----|
| PSBJ-URTK 6 FARBLOS | | 3026450 | 10 |
| PSBJ-URTK 6 RD | | 3026719 | 10 |
| PSBJ-URTK 6 BU | | 3026434 | 10 |
| PSBJ-URTK 6 YE | | 3026405 | 10 |
| PSBJ-URTK 6 GN | | 3026418 | 10 |
| PSBJ-URTK 6 VT | | 3026421 | 10 |
| PSBJ-URTK 6 BK | | 3026447 | 10 |
| PSBJ-URTK 6 GY | | 3026612 | 10 |
| PSBJ-URTK 6 BN | | 3026971 | 10 |
| C-FCI 1,5/M3 | | 3240032 | 100 |
| C-FCI 2,5/M3 | | 3240037 | 100 |
| C-RCI 1,5/M3 | | 3240016 | 100 |
| C-RCI 2,5/M3 | | 3240021 | 100 |

| Accessories | | | |
|---|--|--|--|
| UC-TM 8, UCT-TM 8, ZB 8 or TMT (EX9,5)R | | | |

UC-TM 8, UCT-TM 8, ZB 8 or TMT (EX9,5)R (see Catalog 5)

UC-TM 8, UCT-TM 8, ZB 8 or TMT (EX9,5)R (see Catalog 5)

UC-TM 8, UCT-TM 8, ZB 8 or TMT (EX9,5)R (see Catalog 5)

FAME plug-in test system

Test terminal strip with PT ... push-in connection, VDE type A14, for wall and DIN rail mounting

The **VDE A14** version described here is suitable as a plug-in test system for three-stage automatic frequency load shedding (AFLS), as zero-power comparison protection, and as stator and rotor ground fault protection.

- The test plugs are assembled according to the circuit diagram
- A transparent covering hood protects the jumpers. The covering hood can only be removed by dismantling the test plug
- All VDE-specified 7, 14, and 19-pos. versions are supplied with exclusive coding for the matching test plug and blind plug
- The components are supplied pre-marked according to the VDE Directive
- Test signals can be connected with touch-proof safety test leads (CAT III and IV/1000 V according to EN 61010-031)
- The test plugs are equipped with two gray test sockets per position, for further color versions, see the range of accessories
- Additional test leads, assembled with ring and fork-type cable lugs, can be attached with test sockets
- Other VDE versions available on request

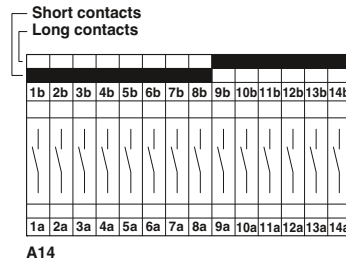

6 (10) mm², 30 A, test terminal strip, for wall mounting, VDE coded type A14

| Notes: |
|---|
| To create panel cutouts, see phoenixcontact.net/products. |
| ¹⁾ Derating curve available on request. |
| ²⁾ Rated surge voltage of 5 kV. |

| Max. electrical data | |
|---|--|
| Rated data | |
| Rated voltage | [V] 400 ²⁾ |
| Nominal current / cross section | [A] / [mm ²] 24 ¹⁾ /6 |
| Rated cross section | [mm ²] 6 |
| Cross section range | AWG 20 - 8 |
| Connection capacity | |
| 1 conductor | [mm ²] 0.5 - 10 |
| 2 stranded conductors with a TWIN ferrule | [mm ²] 0.5 - 6 |
| Plug-in connection cross sections | [mm ²] 1 - 10 |
| General data | |
| Stripping length | [mm] 12 |
| Tightening torque for wall fastening | [Nm] 0.8 - 1 |
| Panel thickness | [mm] 1 - 4 |
| Tightening torque: test socket screw | [Nm] - |
| Insulating material | PA |
| Inflammability class according to UL 94 | V0 |

| Technical data | | | |
|----------------------------|-------------------|-------------------------------------|----------------|
| I_{max} [A] | U_{max} [V] | max. Ø [mm ²] | AWG |
| 30 | 400 ²⁾ | 0.5 - 10 | 20 - 8 |
| IEC 60947-7-1 | UL/CUL | CSA | IEC/EN 60079-7 |
| Connection capacity | | | |
| solid | stranded | ferrule with/without plastic sleeve | |
| 0.5 - 10 | 0.5 - 6 | 0.5 - 6 | 0.5 - 6 |
| 1 - 10 | - | 1 - 6 | 1 - 6 |

| Description | Color |
|---|-------|
| Test terminal strip , for wall mounting | gray |
| Test terminal strip , for mounting on NS 35... | gray |
| Test plug , with twist grip | gray |
| With standard handle | gray |
| Test plug , 1-pos., with cover | gray |
| Blind plug , sealable | gray |

| Ordering data | | |
|---------------------|-----------|-------------|
| Type | Order No. | Pcs. / Pkt. |
| PTWE 6-2/A14 | 3069439 | 1 |

| | |
|--|-------------------|
| Test socket , insulated | transparent |
| | red |
| | blue |
| | yellow |
| | green |
| | violet |
| | black |
| | gray |
| | brown |
| Cover profile , supply length 1 m | transparent |
| Cover profile holder , can be snapped on and sealed | gray |
| Cover profile , supply length 1 m | transparent |
| End brackets , for AP-ME cover profile, sealable, with storage option for jumpers | gray |
| Holder , for AP-ME cover profile | gray |
| Fork-type cable lug , insulated according to UL | red |
| | blue |
| Ring cable lug , insulated according to UL | red |
| | blue |
| Screwdriver | SF-SL 0,8X4,0-100 |

| Accessories | | |
|--------------------------|---------|----|
| AP RSC-T | 3059139 | 10 |
| APH-UTWE 6-2 | 3069057 | 10 |
| SF-SL 0,8X4,0-100 | 1212551 | 10 |

| | |
|--------------------------------|---|
| Lateral groove labeling | UC-TM 8, UCT-TM 8, ZB 8 or TMT (EX9,5)R (see Catalog 5) |
|--------------------------------|---|



6 (10) mm², 30 A, test terminal strip, for DIN rail mounting, VDE coded type A14



24 A, test plug, bridge assignment according to circuit diagram, VDE coded type A14



Blind plug, VDE coded type A14

| Technical data | | | |
|----------------------|----------------------|-------------------------------------|----------------------|
| I _{max} [A] | U _{max} [V] | max. Ø [mm ²] | AWG |
| 30 | 400 ²⁾ | 0.5 - 10 | 20 - 8 |
| IEC 60947-7-1 | | | |
| IEC | UL/CUL | CSA | IEC/EN 60079-7 |
| 400 ²⁾ | - | - | - |
| 24 ¹⁾ /6 | - | - | - |
| 6 | - | - | - |
| 20 - 8 | - | - | - |
| solid | stranded | ferrule with/without plastic sleeve | |
| 0.5 - 10 | 0.5 - 6 | 0.5 - 6 | 0.5 - 6 0.5 - 1.5 |
| 1 - 10 | - | 1 - 6 | 1 - 6 |
| 12 | - | - | - |
| - | - | - | - |
| - | - | - | - |
| - | - | - | - |
| PA | - | - | - |
| V0 | - | - | - |

| Technical data | | | |
|----------------------|----------------------|-------------------------------------|---------|
| I _{max} [A] | U _{max} [V] | max. Ø [mm ²] | AWG |
| 24 | 400 ²⁾ | 0.5 - 2.5 | 20 - 14 |
| IEC | | | |
| UL/CUL | CSA | IEC/EN 60079-7 | |
| 400 ²⁾ | - | - | - |
| 24/2.5 | - | - | - |
| 6 | - | - | - |
| 20 - 14 | - | - | - |
| solid | stranded | ferrule with/without plastic sleeve | |
| - | 0.5 - 2.5 | - | - |
| - | - | - | - |
| - | - | - | - |
| 0.5 - 0.6 | - | - | - |
| PA | - | - | - |
| V0 | - | - | - |

| Technical data | | | |
|----------------|----------|-------------------------------------|-----|
| | | max. Ø [mm ²] | AWG |
| | | - | - |
| IEC | | | |
| UL/CUL | CSA | IEC/EN 60079-7 | |
| - | - | - | - |
| - | - | - | - |
| - | - | - | - |
| - | - | - | - |
| solid | stranded | ferrule with/without plastic sleeve | |
| - | - | - | - |
| - | - | - | - |
| - | - | - | - |
| PA | - | - | - |
| V0 | - | - | - |

| Ordering data | | |
|---------------|-----------|-------------|
| Type | Order No. | Pcs. / Pkt. |
| PTRE 6-2/A14 | 3069452 | 1 |

| Ordering data | | |
|---------------|-----------|-------------|
| Type | Order No. | Pcs. / Pkt. |
| FTPR-2/A14 | 3069487 | 1 |
| FTP-2/A14 | 3069474 | 1 |
| FTP-2/1 | 3069469 | 1 |

| Ordering data | | |
|---------------|-----------|-------------|
| Type | Order No. | Pcs. / Pkt. |
| FBP-2/A14 | 3069500 | 1 |

| Accessories | | | |
|-------------|-------------|---------|----|
| AP-ME | METER | 3034361 | 10 |
| APH-ME | | 3034374 | 10 |
| APT-ME | | 3034358 | 10 |
| SF-SL | 0,8X4,0-100 | 1212551 | 10 |

| Accessories | | | |
|---------------------|--|---------|-----|
| PSBJ-URTK 6 FARBLOS | | 3026450 | 10 |
| PSBJ-URTK 6 RD | | 3026719 | 10 |
| PSBJ-URTK 6 BU | | 3026434 | 10 |
| PSBJ-URTK 6 YE | | 3026405 | 10 |
| PSBJ-URTK 6 GN | | 3026418 | 10 |
| PSBJ-URTK 6 VT | | 3026421 | 10 |
| PSBJ-URTK 6 BK | | 3026447 | 10 |
| PSBJ-URTK 6 GY | | 3026612 | 10 |
| PSBJ-URTK 6 BN | | 3026971 | 10 |
| C-FCI 1,5/M3 | | 3240032 | 100 |
| C-FCI 2,5/M3 | | 3240037 | 100 |
| C-RCI 1,5/M3 | | 3240016 | 100 |
| C-RCI 2,5/M3 | | 3240021 | 100 |

| Accessories | | | |
|---|-----------------|--|--|
| UC-TM 8, UCT-TM 8, ZB 8 or TMT (EX9,5)R | (see Catalog 5) | | |

UC-TM 8, UCT-TM 8, ZB 8 or TMT (EX9,5)R (see Catalog 5)

UC-TM 8, UCT-TM 8, ZB 8 or TMT (EX9,5)R (see Catalog 5)

UC-TM 8, UCT-TM 8, ZB 8 or TMT (EX9,5)R (see Catalog 5)

FAME plug-in test system

Test terminal strip with PT ... push-in connection, VDE type B14, for wall and DIN rail mounting

The **VDE B14** version described here is suitable as a plug-in test system in overcurrent directional protection, distance protection for high and medium voltage, as well as voltage regulation.

- The test plugs are assembled with jumpers and contact tab lengths according to the circuit diagram
- A transparent covering hood protects the jumpers. The covering hood can only be removed by dismantling the test plug
- All VDE-specified 7, 14, and 19-pos. versions are supplied with exclusive coding for the matching test plug and blind plug
- The components are supplied pre-marked according to the VDE Directive
- Test signals can be connected with touch-proof safety test leads (CAT III and IV/1000 V according to EN 61010-031)
- The test plugs are equipped with two gray test sockets per position, for further color versions, see the range of accessories
- Additional test leads, assembled with ring and fork-type cable lugs, can be attached with test sockets
- Other VDE versions available on request

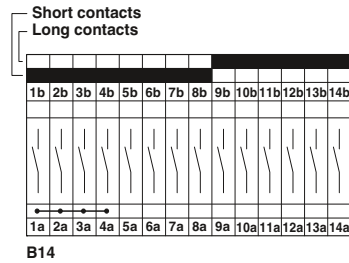

6 (10) mm², 30 A, test terminal strip, for wall mounting, VDE coded type B14

| Notes: |
|---|
| To create panel cutouts, see phoenixcontact.net/products. |
| 1) Derating curve available on request. |
| 2) Rated surge voltage of 5 kV. |

| Max. electrical data | |
|---|--|
| Rated data | |
| Rated voltage | [V] 400 ²⁾ |
| Nominal current / cross section | [A] / [mm ²] 24 ¹⁾ /6 |
| Rated cross section | [mm ²] 6 |
| Cross section range | AWG 20 - 8 |
| Connection capacity | |
| 1 conductor | [mm ²] 0.5 - 10 |
| 2 stranded conductors with a TWIN ferrule | [mm ²] 0.5 - 6 |
| Plug-in connection cross sections | [mm ²] 1 - 10 |
| General data | |
| Stripping length | [mm] 12 |
| Tightening torque for wall fastening | [Nm] 0.8 - 1 |
| Panel thickness | [mm] 1 - 4 |
| Tightening torque: test socket screw | [Nm] - |
| Insulating material | PA |
| Inflammability class according to UL 94 | V0 |

| Technical data | | | |
|---------------------|-------------------------|-----------------------------|----------------|
| I_{max} [A] | U_{max} [V] | max. Ø [mm ²] | AWG |
| 30 | 400²⁾ | 0.5 - 10 | 20 - 8 |
| IEC 60947-7-1 | UL/CUL | CSA | IEC/EN 60079-7 |
| Connection capacity | | ferrule | |
| solid | stranded | with/without plastic sleeve | |
| 0.5 - 10 | 0.5 - 6 | 0.5 - 6 | 0.5 - 6 |
| 1 - 10 | - | 1 - 6 | 1 - 6 |

| Description | Color |
|---|-------|
| Test terminal strip , for wall mounting | gray |
| Test terminal strip , for mounting on NS 35... | gray |
| Test plug , with twist grip | gray |
| With standard handle | gray |
| Test plug , 1-pos., with cover | gray |
| Blind plug , sealable | gray |

| Ordering data | | |
|---------------------|----------------|-------------|
| Type | Order No. | Pcs. / Pkt. |
| PTWE 6-2/B14 | 3069440 | 1 |

| | |
|--|---|
| Test socket , insulated | transparent red blue yellow green violet black gray brown |
| Cover profile , supply length 1 m | transparent |
| Cover profile holder , can be snapped on and sealed | gray |
| Cover profile , supply length 1 m | transparent |
| End brackets , for AP-ME cover profile, sealable, with storage option for jumpers | gray |
| Holder , for AP-ME cover profile | gray |
| Fork-type cable lug , insulated according to UL | red blue |
| Ring cable lug , insulated according to UL | red blue |
| Screwdriver | SF-SL 0,8X4,0-100 |

| Accessories | | |
|--------------------------|----------------|-----------|
| AP RSC-T | 3059139 | 10 |
| APH-UTWE 6-2 | 3069057 | 10 |
| SF-SL 0,8X4,0-100 | 1212551 | 10 |

| | |
|--------------------------------|--|
| Lateral groove labeling | UC-TM 8, UCT-TM 8, ZB 8 or TMT (EX9,5)R (see Catalog 5) |
|--------------------------------|--|



6 (10) mm², 30 A, test terminal strip, for DIN rail mounting, VDE coded type B14



24 A, test plug, bridge assignment according to circuit diagram, VDE coded type B14



Blind plug, VDE coded type B14

| Technical data | | | |
|----------------------|----------------------|-------------------------------------|----------------------|
| I _{max} [A] | U _{max} [V] | max. Ø [mm ²] | AWG |
| 30 | 400 ²⁾ | 0.5 - 10 | 20 - 8 |
| IEC 60947-7-1 | | | |
| IEC | | | |
| UL/CUL | CSA | IEC/EN 60079-7 | |
| 400 ²⁾ | - | - | - |
| 24 ¹⁾ /6 | - | - | - |
| 6 | - | - | - |
| 20 - 8 | - | - | - |
| solid | stranded | ferrule with/without plastic sleeve | |
| 0.5 - 10 | 0.5 - 6 | 0.5 - 6 | 0.5 - 6 0.5 - 1.5 |
| 1 - 10 | - | 1 - 6 | 1 - 6 |
| 12 | - | - | - |
| - | - | - | - |
| - | - | - | - |
| - | - | - | - |
| PA | - | - | - |
| V0 | - | - | - |

| Technical data | | | |
|----------------------|----------------------|-------------------------------------|---------|
| I _{max} [A] | U _{max} [V] | max. Ø [mm ²] | AWG |
| 24 | 400 ²⁾ | 0.5 - 2.5 | 20 - 14 |
| IEC | | | |
| UL/CUL | CSA | IEC/EN 60079-7 | |
| 400 ²⁾ | - | - | - |
| 24/2.5 | - | - | - |
| 6 | - | - | - |
| 20 - 14 | - | - | - |
| solid | stranded | ferrule with/without plastic sleeve | |
| - | 0.5 - 2.5 | - | - |
| - | - | - | - |
| - | - | - | - |
| 0.5 - 0.6 | - | - | - |
| PA | - | - | - |
| V0 | - | - | - |

| Technical data | | | |
|----------------|----------|-------------------------------------|-----|
| | | max. Ø [mm ²] | AWG |
| - | - | - | - |
| IEC | | | |
| UL/CUL | CSA | IEC/EN 60079-7 | |
| - | - | - | - |
| - | - | - | - |
| - | - | - | - |
| - | - | - | - |
| solid | stranded | ferrule with/without plastic sleeve | |
| - | - | - | - |
| - | - | - | - |
| - | - | - | - |
| PA | - | - | - |
| V0 | - | - | - |

| Ordering data | | |
|---------------|-----------|-------------|
| Type | Order No. | Pcs. / Pkt. |
| PTRE 6-2/B14 | 3069453 | 1 |
| FTPR-2/B14 | 3069488 | 1 |
| FTP-2/B14 | 3069475 | 1 |
| FTP-2/1 | 3069469 | 1 |
| FBP-2/B14 | 3069501 | 1 |

| Ordering data | | |
|---------------|-----------|-------------|
| Type | Order No. | Pcs. / Pkt. |
| PTRE 6-2/B14 | 3069453 | 1 |
| FTPR-2/B14 | 3069488 | 1 |
| FTP-2/B14 | 3069475 | 1 |
| FTP-2/1 | 3069469 | 1 |
| FBP-2/B14 | 3069501 | 1 |

| Ordering data | | |
|---------------|-----------|-------------|
| Type | Order No. | Pcs. / Pkt. |
| PTRE 6-2/B14 | 3069453 | 1 |
| FTPR-2/B14 | 3069488 | 1 |
| FTP-2/B14 | 3069475 | 1 |
| FTP-2/1 | 3069469 | 1 |
| FBP-2/B14 | 3069501 | 1 |

| Accessories | | | |
|-------------|-------------|---------|----|
| AP-ME | METER | 3034361 | 10 |
| APH-ME | | 3034374 | 10 |
| APT-ME | | 3034358 | 10 |
| SF-SL | 0,8X4,0-100 | 1212551 | 10 |

| Accessories | | | |
|---------------------|--|---------|-----|
| PSBJ-URTK 6 FARBLOS | | 3026450 | 10 |
| PSBJ-URTK 6 RD | | 3026719 | 10 |
| PSBJ-URTK 6 BU | | 3026434 | 10 |
| PSBJ-URTK 6 YE | | 3026405 | 10 |
| PSBJ-URTK 6 GN | | 3026418 | 10 |
| PSBJ-URTK 6 VT | | 3026421 | 10 |
| PSBJ-URTK 6 BK | | 3026447 | 10 |
| PSBJ-URTK 6 GY | | 3026612 | 10 |
| PSBJ-URTK 6 BN | | 3026971 | 10 |
| C-FCI 1,5/M3 | | 3240032 | 100 |
| C-FCI 2,5/M3 | | 3240037 | 100 |
| C-RCI 1,5/M3 | | 3240016 | 100 |
| C-RCI 2,5/M3 | | 3240021 | 100 |

| Accessories | | | |
|---|--|--|--|
| UC-TM 8, UCT-TM 8, ZB 8 or TMT (EX9,5)R | | | |

UC-TM 8, UCT-TM 8, ZB 8 or TMT (EX9,5)R (see Catalog 5)

UC-TM 8, UCT-TM 8, ZB 8 or TMT (EX9,5)R (see Catalog 5)

UC-TM 8, UCT-TM 8, ZB 8 or TMT (EX9,5)R (see Catalog 5)

FAME plug-in test system

Test terminal strip with PT ... push-in connection, VDE type C14, for wall and DIN rail mounting

The **VDE C14** version described here is suitable as a plug-in test system in overcurrent time protection, unbalanced load protection, and stator ground fault protection for busbar operation.

- The test plugs are assembled with jumpers and contact tab lengths according to the circuit diagram
- A transparent covering hood protects the jumpers. The covering hood can only be removed by dismantling the test plug
- All VDE-specified 7, 14, and 19-pos. versions are supplied with exclusive coding for the matching test plug and blind plug
- The components are supplied pre-marked according to the VDE Directive
- Test signals can be connected with touch-proof safety test leads (CAT III and IV/1000 V according to EN 61010-031)
- The test plugs are equipped with two gray test sockets per position, for further color versions, see the range of accessories
- Additional test leads, assembled with ring and fork-type cable lugs, can be attached with test sockets
- Other VDE versions available on request

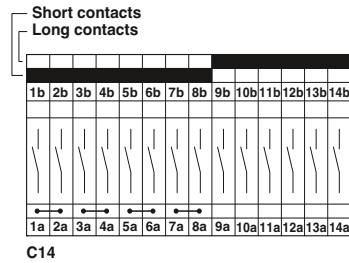

6 (10) mm², 30 A, test terminal strip, for wall mounting, VDE coded type C14

| Notes: |
|---|
| To create panel cutouts, see phoenixcontact.net/products. |
| ¹⁾ Derating curve available on request. |
| ²⁾ Rated surge voltage of 5 kV. |

| Max. electrical data | |
|---|--|
| Rated data | |
| Rated voltage | [V] 400 ²⁾ |
| Nominal current / cross section | [A] / [mm ²] 24 ¹⁾ /6 |
| Rated cross section | [mm ²] 6 |
| Cross section range | AWG 20 - 8 |
| Connection capacity | |
| 1 conductor | [mm ²] 0.5 - 10 |
| 2 stranded conductors with a TWIN ferrule | [mm ²] 0.5 - 6 |
| Plug-in connection cross sections | [mm ²] 1 - 10 |
| General data | |
| Stripping length | [mm] 12 |
| Tightening torque for wall fastening | [Nm] 0.8 - 1 |
| Panel thickness | [mm] 1 - 4 |
| Tightening torque: test socket screw | [Nm] - |
| Insulating material | PA |
| Inflammability class according to UL 94 | V0 |

| Technical data | | | |
|---------------------|-------------------|-----------------------------|----------------|
| I_{max} [A] | U_{max} [V] | max. Ø [mm ²] | AWG |
| 30 | 400 ²⁾ | 0.5 - 10 | 20 - 8 |
| IEC 60947-7-1 | UL/CUL | CSA | IEC/EN 60079-7 |
| Connection capacity | | ferrule | |
| solid | stranded | with/without plastic sleeve | |
| 0.5 - 10 | 0.5 - 6 | 0.5 - 6 | 0.5 - 6 |
| 1 - 10 | - | 1 - 6 | 1 - 6 |

| Description | Color |
|---|-------|
| Test terminal strip , for wall mounting | gray |
| Test terminal strip , for mounting on NS 35... | gray |
| Test plug , with twist grip | gray |
| With standard handle | gray |
| Test plug , 1-pos., with cover | gray |
| Blind plug , sealable | gray |

| Ordering data | | |
|---------------------|-----------|-------------|
| Type | Order No. | Pcs. / Pkt. |
| PTWE 6-2/C14 | 3069441 | 1 |

| | |
|--|-------------------|
| Test socket , insulated | transparent |
| | red |
| | blue |
| | yellow |
| | green |
| | violet |
| | black |
| | gray |
| | brown |
| Cover profile , supply length 1 m | transparent |
| Cover profile holder , can be snapped on and sealed | gray |
| Cover profile , supply length 1 m | transparent |
| End brackets , for AP-ME cover profile, sealable, with storage option for jumpers | gray |
| Holder , for AP-ME cover profile | gray |
| Fork-type cable lug , insulated according to UL | red |
| | blue |
| Ring cable lug , insulated according to UL | red |
| | blue |
| Screwdriver | SF-SL 0,8X4,0-100 |

| Accessories | | |
|--------------------------|---------|----|
| AP RSC-T | 3059139 | 10 |
| APH-UTWE 6-2 | 3069057 | 10 |
| SF-SL 0,8X4,0-100 | 1212551 | 10 |

| | |
|--------------------------------|---|
| Lateral groove labeling | UC-TM 8, UCT-TM 8, ZB 8 or TMT (EX9,5)R (see Catalog 5) |
|--------------------------------|---|



6 (10) mm², 30 A, test terminal strip, for DIN rail mounting, VDE coded type C14



24 A, test plug, bridge assignment according to circuit diagram, VDE coded type C14



Blind plug, VDE coded type C14

| Technical data | | | |
|----------------------|----------------------|-------------------------------------|----------------------|
| I _{max} [A] | U _{max} [V] | max. Ø [mm ²] | AWG |
| 30 | 400 ²⁾ | 0.5 - 10 | 20 - 8 |
| IEC 60947-7-1 | | | |
| IEC | UL/CUL | CSA | IEC/EN 60079-7 |
| 400 ²⁾ | - | - | - |
| 24 ¹⁾ /6 | - | - | - |
| 6 | - | - | - |
| 20 - 8 | - | - | - |
| solid | stranded | ferrule with/without plastic sleeve | |
| 0.5 - 10 | 0.5 - 6 | 0.5 - 6 | 0.5 - 6 0.5 - 1.5 |
| 1 - 10 | - | 1 - 6 | 1 - 6 |
| 12 | - | - | - |
| - | - | - | - |
| - | - | - | - |
| - | - | - | - |
| PA | - | - | - |
| V0 | - | - | - |

| Technical data | | | |
|----------------------|----------------------|-------------------------------------|---------|
| I _{max} [A] | U _{max} [V] | max. Ø [mm ²] | AWG |
| 24 | 400 ²⁾ | 0.5 - 2.5 | 20 - 14 |
| IEC | | | |
| UL/CUL | CSA | IEC/EN 60079-7 | |
| 400 ²⁾ | - | - | - |
| 24/2.5 | - | - | - |
| 6 | - | - | - |
| 20 - 14 | - | - | - |
| solid | stranded | ferrule with/without plastic sleeve | |
| - | 0.5 - 2.5 | - | - |
| - | - | - | - |
| - | - | - | - |
| 0.5 - 0.6 | - | - | - |
| PA | - | - | - |
| V0 | - | - | - |

| Technical data | | | |
|----------------|----------|-------------------------------------|-----|
| | | max. Ø [mm ²] | AWG |
| | | - | - |
| IEC | | | |
| UL/CUL | CSA | IEC/EN 60079-7 | |
| - | - | - | - |
| - | - | - | - |
| - | - | - | - |
| - | - | - | - |
| solid | stranded | ferrule with/without plastic sleeve | |
| - | - | - | - |
| - | - | - | - |
| - | - | - | - |
| PA | - | - | - |
| V0 | - | - | - |

| Ordering data | | |
|---------------|-----------|-------------|
| Type | Order No. | Pcs. / Pkt. |
| PTRE 6-2/C14 | 3069454 | 1 |
| FTP-2/C14 | 3069489 | 1 |
| FTP-2/C14 | 3069476 | 1 |
| FTP-2/1 | 3069469 | 1 |
| FBP-2/C14 | 3069502 | 1 |

| Ordering data | | |
|---------------|-----------|-------------|
| Type | Order No. | Pcs. / Pkt. |
| FTP-2/C14 | 3069489 | 1 |
| FTP-2/C14 | 3069476 | 1 |
| FTP-2/1 | 3069469 | 1 |
| FBP-2/C14 | 3069502 | 1 |

| Ordering data | | |
|---------------|-----------|-------------|
| Type | Order No. | Pcs. / Pkt. |
| FBP-2/C14 | 3069502 | 1 |

| Accessories | | | |
|-------------|-------------|---------|----|
| AP-ME | METER | 3034361 | 10 |
| APH-ME | | 3034374 | 10 |
| APT-ME | | 3034358 | 10 |
| SF-SL | 0,8X4,0-100 | 1212551 | 10 |

| Accessories | | | |
|---------------------|--|---------|-----|
| PSBJ-URTK 6 FARBLOS | | 3026450 | 10 |
| PSBJ-URTK 6 RD | | 3026719 | 10 |
| PSBJ-URTK 6 BU | | 3026434 | 10 |
| PSBJ-URTK 6 YE | | 3026405 | 10 |
| PSBJ-URTK 6 GN | | 3026418 | 10 |
| PSBJ-URTK 6 VT | | 3026421 | 10 |
| PSBJ-URTK 6 BK | | 3026447 | 10 |
| PSBJ-URTK 6 GY | | 3026612 | 10 |
| PSBJ-URTK 6 BN | | 3026971 | 10 |
| C-FCI 1,5/M3 | | 3240032 | 100 |
| C-FCI 2,5/M3 | | 3240037 | 100 |
| C-RCI 1,5/M3 | | 3240016 | 100 |
| C-RCI 2,5/M3 | | 3240021 | 100 |

| Accessories | | | |
|---|--|--|--|
| UC-TM 8, UCT-TM 8, ZB 8 or TMT (EX9,5)R | | | |

UC-TM 8, UCT-TM 8, ZB 8 or TMT (EX9,5)R (see Catalog 5)

UC-TM 8, UCT-TM 8, ZB 8 or TMT (EX9,5)R (see Catalog 5)

UC-TM 8, UCT-TM 8, ZB 8 or TMT (EX9,5)R (see Catalog 5)

FAME plug-in test system

Test terminal strip with PT ... push-in connection, VDE type B19, for wall and DIN rail mounting

The **VDE B19** version described here is suitable as a plug-in test system in distance protection for high voltage.

- The test plugs are assembled with jumpers and contact tab lengths according to the circuit diagram
- A transparent covering hood protects the jumpers. The covering hood can only be removed by dismantling the test plug
- All VDE-specified 7, 14, and 19-pos. versions are supplied with exclusive coding for the matching test plug and blind plug
- The components are supplied pre-marked according to the VDE Directive
- Test signals can be connected with touch-proof safety test leads (CAT III and IV/1000 V according to EN 61010-031)
- The test plugs are equipped with two gray test sockets per position, for further color versions, see the range of accessories
- Additional test leads, assembled with ring and fork-type cable lugs, can be attached with test sockets
- Other VDE versions available on request



6 (10) mm², 30 A, test terminal strip, for wall mounting, VDE coded type B19

| Notes: | |
|---|--|
| To create panel cutouts, see phoenixcontact.net/products . | |
| 1) Derating curve available on request. | |
| 2) Rated surge voltage of 5 kV. | |

| Max. electrical data | |
|---|--|
| Rated data | |
| Rated voltage | [V] 400 ²⁾ |
| Nominal current / cross section | [A] / [mm ²] 24 ¹⁾ /6 |
| Rated cross section | [mm ²] 6 |
| Cross section range | AWG 20 - 8 |
| Connection capacity | |
| 1 conductor | [mm ²] 0.5 - 10 |
| 2 stranded conductors with a TWIN ferrule | [mm ²] 0.5 - 6 |
| Plug-in connection cross sections | [mm ²] 1 - 10 |
| General data | |
| Stripping length | [mm] 12 |
| Tightening torque for wall fastening | [Nm] 0.8 - 1 |
| Panel thickness | [mm] 1 - 4 |
| Tightening torque: test socket screw | [Nm] - |
| Insulating material | PA |
| Inflammability class according to UL 94 | V0 |

| Technical data | | | |
|---|-------------------|---|----------------|
| I_{max} [A] | U_{max} [V] | max. Ø [mm ²] | AWG |
| 30 | 400 ²⁾ | 0.5 - 10 | 20 - 8 |
| IEC 60947-7-1 | UL/CUL | CSA | IEC/EN 60079-7 |
| Connection capacity | | ferrule | |
| solid | stranded | with/without plastic sleeve | |
| 0.5 - 10 | 0.5 - 6 | 0.5 - 6 | 0.5 - 6 |
| 1 - 10 | - | 1 - 6 | 1 - 6 |
| General data | | Tightening torque for wall fastening [Nm] | |
| Stripping length [mm] | | 0.8 - 1 | |
| Panel thickness [mm] | | 1 - 4 | |
| Tightening torque: test socket screw [Nm] | | - | |
| Insulating material | | PA | |
| Inflammability class according to UL 94 | | V0 | |

| Description | Color |
|---|-------|
| Test terminal strip , for wall mounting | gray |
| Test terminal strip , for mounting on NS 35... | gray |
| Test plug , with twist grip | gray |
| With standard handle | gray |
| Test plug , 1-pos., with cover | gray |
| Blind plug , sealable | gray |

| | |
|--|---|
| Test socket , insulated | transparent |
| | red |
| | blue |
| | yellow |
| | green |
| | violet |
| | black |
| | gray |
| | brown |
| Cover profile , supply length 1 m | transparent |
| Cover profile holder , can be snapped on and sealed | gray |
| Cover profile , supply length 1 m | transparent |
| End brackets , for AP-ME cover profile, sealable, with storage option for jumpers | gray |
| Holder , for AP-ME cover profile | gray |
| Fork-type cable lug , insulated according to UL | red |
| | blue |
| Ring cable lug , insulated according to UL | red |
| | blue |
| Screwdriver | SF-SL 0,8X4,0-100 |
| Lateral groove labeling | UC-TM 8, UCT-TM 8, ZB 8 or TMT (EX9,5)R (see Catalog 5) |

| Ordering data | | |
|---------------------|-----------|-------------|
| Type | Order No. | Pcs. / Pkt. |
| PTWE 6-2/B19 | 3069442 | 1 |

| Accessories | | |
|---|---------|----|
| AP RSC-T | 3059139 | 10 |
| APH-UTWE 6-2 | 3069057 | 10 |
| SF-SL 0,8X4,0-100 | 1212551 | 10 |
| UC-TM 8, UCT-TM 8, ZB 8 or TMT (EX9,5)R (see Catalog 5) | | |



6 (10) mm², 30 A, test terminal strip, for DIN rail mounting, VDE coded type B19



24 A, test plug, bridge assignment according to circuit diagram, VDE coded type B19



Blind plug, VDE coded type B19

| Technical data | | | |
|----------------------|----------------------|-------------------------------------|----------------------|
| I _{max} [A] | U _{max} [V] | max. Ø [mm ²] | AWG |
| 30 | 400 ²⁾ | 0.5 - 10 | 20 - 8 |
| IEC 60947-7-1 | | | |
| IEC | UL/CUL | CSA | IEC/EN 60079-7 |
| 400 ²⁾ | - | - | - |
| 24 ¹⁾ /6 | - | - | - |
| 6 | - | - | - |
| 20 - 8 | - | - | - |
| solid | stranded | ferrule with/without plastic sleeve | |
| 0.5 - 10 | 0.5 - 6 | 0.5 - 6 | 0.5 - 6 0.5 - 1.5 |
| 1 - 10 | - | 1 - 6 | 1 - 6 |
| 12 | - | - | - |
| - | - | - | - |
| - | - | - | - |
| - | - | - | - |
| PA | - | - | - |
| V0 | - | - | - |

| Technical data | | | |
|----------------------|----------------------|-------------------------------------|---------|
| I _{max} [A] | U _{max} [V] | max. Ø [mm ²] | AWG |
| 24 | 400 ²⁾ | 0.5 - 2.5 | 20 - 14 |
| IEC | | | |
| UL/CUL | CSA | IEC/EN 60079-7 | |
| 400 ²⁾ | - | - | - |
| 24/2.5 | - | - | - |
| 6 | - | - | - |
| 20 - 14 | - | - | - |
| solid | stranded | ferrule with/without plastic sleeve | |
| - | 0.5 - 2.5 | - | - |
| - | - | - | - |
| - | - | - | - |
| 0.5 - 0.6 | - | - | - |
| PA | - | - | - |
| V0 | - | - | - |

| Technical data | | | |
|----------------|----------|-------------------------------------|-----|
| | | max. Ø [mm ²] | AWG |
| | | - | - |
| IEC | | | |
| UL/CUL | CSA | IEC/EN 60079-7 | |
| - | - | - | - |
| - | - | - | - |
| - | - | - | - |
| - | - | - | - |
| solid | stranded | ferrule with/without plastic sleeve | |
| - | - | - | - |
| - | - | - | - |
| - | - | - | - |
| PA | - | - | - |
| V0 | - | - | - |

| Ordering data | | |
|---------------|-----------|-------------|
| Type | Order No. | Pcs. / Pkt. |
| PTRE 6-2/B19 | 3069455 | 1 |
| FTP-2/B19 | 3069490 | 1 |
| FTP-2/B19 | 3069477 | 1 |
| FTP-2/1 | 3069469 | 1 |

| Ordering data | | |
|---------------|-----------|-------------|
| Type | Order No. | Pcs. / Pkt. |
| FBP-2/B19 | 3069503 | 1 |

| Ordering data | | |
|---------------|-----------|-------------|
| Type | Order No. | Pcs. / Pkt. |
| FBP-2/B19 | 3069503 | 1 |

| Accessories | | | |
|-------------------|-------|---------|----|
| AP-ME | METER | 3034361 | 10 |
| APH-ME | | 3034374 | 10 |
| APT-ME | | 3034358 | 10 |
| SF-SL 0,8X4,0-100 | | 1212551 | 10 |

| Accessories | | | |
|---------------------|--|---------|-----|
| PSBJ-URTK 6 FARBLOS | | 3026450 | 10 |
| PSBJ-URTK 6 RD | | 3026719 | 10 |
| PSBJ-URTK 6 BU | | 3026434 | 10 |
| PSBJ-URTK 6 YE | | 3026405 | 10 |
| PSBJ-URTK 6 GN | | 3026418 | 10 |
| PSBJ-URTK 6 VT | | 3026421 | 10 |
| PSBJ-URTK 6 BK | | 3026447 | 10 |
| PSBJ-URTK 6 GY | | 3026612 | 10 |
| PSBJ-URTK 6 BN | | 3026971 | 10 |
| C-FCI 1,5/M3 | | 3240032 | 100 |
| C-FCI 2,5/M3 | | 3240037 | 100 |
| C-RCI 1,5/M3 | | 3240016 | 100 |
| C-RCI 2,5/M3 | | 3240021 | 100 |

| Accessories | | | |
|---|--|--|--|
| UC-TM 8, UCT-TM 8, ZB 8 or TMT (EX9,5)R | | | |

UC-TM 8, UCT-TM 8, ZB 8 or TMT (EX9,5)R (see Catalog 5)

UC-TM 8, UCT-TM 8, ZB 8 or TMT (EX9,5)R (see Catalog 5)

UC-TM 8, UCT-TM 8, ZB 8 or TMT (EX9,5)R (see Catalog 5)

FAME plug-in test system

Test terminal strip with PT ... push-in connection, VDE type C19, for wall and DIN rail mounting

The **VDE C19** version described here is suitable as a plug-in test system in distance protection as system busbar protection, overcurrent directional protection, and current comparison protection for cables.

- The test plugs are assembled with jumpers and contact tab lengths according to the circuit diagram
- A transparent covering hood protects the jumpers. The covering hood can only be removed by dismantling the test plug
- All VDE-specified 7, 14, and 19-pos. versions are supplied with exclusive coding for the matching test plug and blind plug
- The components are supplied pre-marked according to the VDE Directive
- Test signals can be connected with touch-proof safety test leads (CAT III and IV/1000 V according to EN 61010-031)
- The test plugs are equipped with two gray test sockets per position, for further color versions, see the range of accessories
- Additional test leads, assembled with ring and fork-type cable lugs, can be attached with test sockets
- Other VDE versions available on request



6 (10) mm², 30 A, test terminal strip, for wall mounting, VDE coded type C19

| Notes: |
|---|
| To create panel cutouts, see phoenixcontact.net/products. |
| ¹⁾ Derating curve available on request. |
| ²⁾ Rated surge voltage of 5 kV. |

| Max. electrical data | |
|---|--|
| Rated data | |
| Rated voltage | [V] 400 ²⁾ |
| Nominal current / cross section | [A] / [mm ²] 24 ¹⁾ /6 |
| Rated cross section | [mm ²] 6 |
| Cross section range | AWG 20 - 8 |
| Connection capacity | |
| 1 conductor | [mm ²] 0.5 - 10 |
| 2 stranded conductors with a TWIN ferrule | [mm ²] 0.5 - 6 |
| Plug-in connection cross sections | [mm ²] 1 - 10 |
| General data | |
| Stripping length | [mm] 12 |
| Tightening torque for wall fastening | [Nm] 0.8 - 1 |
| Panel thickness | [mm] 1 - 4 |
| Tightening torque: test socket screw | [Nm] - |
| Insulating material | PA |
| Inflammability class according to UL 94 | V0 |

| Technical data | | | |
|----------------------|----------------------|-----------------------------|----------------|
| I _{max} [A] | U _{max} [V] | max. Ø [mm ²] | AWG |
| 30 | 400 ²⁾ | 0.5 - 10 | 20 - 8 |
| IEC 60947-7-1 | UL/CUL | CSA | IEC/EN 60079-7 |
| Connection capacity | | ferrule | |
| solid | stranded | with/without plastic sleeve | |
| 0.5 - 10 | 0.5 - 6 | 0.5 - 6 | 0.5 - 6 |
| 1 - 10 | - | 1 - 6 | 1 - 6 |

| Description | Color |
|---|-------|
| Test terminal strip , for wall mounting | gray |
| Test terminal strip , for mounting on NS 35... | gray |
| Test plug , with twist grip | gray |
| With standard handle | gray |
| Test plug , 1-pos., with cover | gray |
| Blind plug , sealable | gray |

| Ordering data | | |
|---------------------|-----------|-------------|
| Type | Order No. | Pcs. / Pkt. |
| PTWE 6-2/C19 | 3069443 | 1 |

| | |
|--|-------------------|
| Test socket , insulated | transparent |
| | red |
| | blue |
| | yellow |
| | green |
| | violet |
| | black |
| | gray |
| | brown |
| Cover profile , supply length 1 m | transparent |
| Cover profile holder , can be snapped on and sealed | gray |
| Cover profile , supply length 1 m | transparent |
| End brackets , for AP-ME cover profile, sealable, with storage option for jumpers | gray |
| Holder , for AP-ME cover profile | gray |
| Fork-type cable lug , insulated according to UL | red |
| | blue |
| Ring cable lug , insulated according to UL | red |
| | blue |
| Screwdriver | SF-SL 0,8X4,0-100 |

| Accessories | | |
|--------------------------|---------|----|
| AP RSC-T | 3059139 | 10 |
| APH-UTWE 6-2 | 3069057 | 10 |
| SF-SL 0,8X4,0-100 | 1212551 | 10 |

| | |
|--------------------------------|---|
| Lateral groove labeling | UC-TM 8, UCT-TM 8, ZB 8 or TMT (EX9,5)R (see Catalog 5) |
|--------------------------------|---|



6 (10) mm², 30 A, test terminal strip, for DIN rail mounting, VDE coded type C19



24 A, test plug, bridge assignment according to circuit diagram, VDE coded type C19



Blind plug, VDE coded type C19

| Technical data | | | |
|----------------------|----------------------|-------------------------------------|----------------------|
| I _{max} [A] | U _{max} [V] | max. Ø [mm ²] | AWG |
| 30 | 400 ²) | 0.5 - 10 | 20 - 8 |
| IEC 60947-7-1 | | | |
| IEC | UL/CUL | CSA | IEC/EN 60079-7 |
| 400 ²) | - | - | - |
| 24 ¹)/6 | - | - | - |
| 6 | - | - | - |
| 20 - 8 | - | - | - |
| solid | stranded | ferrule with/without plastic sleeve | |
| 0.5 - 10 | 0.5 - 6 | 0.5 - 6 | 0.5 - 6 0.5 - 1.5 |
| 1 - 10 | - | 1 - 6 | 1 - 6 |
| 12 | - | - | - |
| - | - | - | - |
| - | - | - | - |
| - | - | - | - |
| PA | - | - | - |
| V0 | - | - | - |

| Technical data | | | |
|----------------------|----------------------|-------------------------------------|---------|
| I _{max} [A] | U _{max} [V] | max. Ø [mm ²] | AWG |
| 24 | 400 ²) | 0.5 - 2.5 | 20 - 14 |
| IEC | | | |
| UL/CUL | CSA | IEC/EN 60079-7 | |
| 400 ²) | - | - | - |
| 24/2.5 | - | - | - |
| 6 | - | - | - |
| 20 - 14 | - | - | - |
| solid | stranded | ferrule with/without plastic sleeve | |
| - | 0.5 - 2.5 | - | - |
| - | - | - | - |
| - | - | - | - |
| 0.5 - 0.6 | - | - | - |
| PA | - | - | - |
| V0 | - | - | - |

| Technical data | | | |
|----------------|----------|-------------------------------------|-----|
| | | max. Ø [mm ²] | AWG |
| | | - | - |
| IEC | | | |
| UL/CUL | CSA | IEC/EN 60079-7 | |
| - | - | - | - |
| - | - | - | - |
| - | - | - | - |
| - | - | - | - |
| solid | stranded | ferrule with/without plastic sleeve | |
| - | - | - | - |
| - | - | - | - |
| - | - | - | - |
| PA | - | - | - |
| V0 | - | - | - |

| Ordering data | | |
|---------------|-----------|-------------|
| Type | Order No. | Pcs. / Pkt. |
| PTRE 6-2/C19 | 3069456 | 1 |
| FTP-2/C19 | 3069491 | 1 |
| FTP-2/C19 | 3069478 | 1 |
| FTP-2/1 | 3069469 | 1 |

| Ordering data | | |
|---------------|-----------|-------------|
| Type | Order No. | Pcs. / Pkt. |
| FBP-2/C19 | 3069504 | 1 |

| Ordering data | | |
|---------------|-----------|-------------|
| Type | Order No. | Pcs. / Pkt. |
| FBP-2/C19 | 3069504 | 1 |

| Accessories | | | |
|-------------|-------------|---------|----|
| AP-ME | METER | 3034361 | 10 |
| APH-ME | | 3034374 | 10 |
| APT-ME | | 3034358 | 10 |
| SF-SL | 0,8X4,0-100 | 1212551 | 10 |

| Accessories | | | |
|---------------------|--|---------|-----|
| PSBJ-URTK 6 FARBLOS | | 3026450 | 10 |
| PSBJ-URTK 6 RD | | 3026719 | 10 |
| PSBJ-URTK 6 BU | | 3026434 | 10 |
| PSBJ-URTK 6 YE | | 3026405 | 10 |
| PSBJ-URTK 6 GN | | 3026418 | 10 |
| PSBJ-URTK 6 VT | | 3026421 | 10 |
| PSBJ-URTK 6 BK | | 3026447 | 10 |
| PSBJ-URTK 6 GY | | 3026612 | 10 |
| PSBJ-URTK 6 BN | | 3026971 | 10 |
| C-FCI 1,5/M3 | | 3240032 | 100 |
| C-FCI 2,5/M3 | | 3240037 | 100 |
| C-RCI 1,5/M3 | | 3240016 | 100 |
| C-RCI 2,5/M3 | | 3240021 | 100 |

| Accessories | | | |
|---|--|--|--|
| UC-TM 8, UCT-TM 8, ZB 8 or TMT (EX9,5)R | | | |

UC-TM 8, UCT-TM 8, ZB 8 or TMT (EX9,5)R (see Catalog 5)

UC-TM 8, UCT-TM 8, ZB 8 or TMT (EX9,5)R (see Catalog 5)

UC-TM 8, UCT-TM 8, ZB 8 or TMT (EX9,5)R (see Catalog 5)

FAME plug-in test system

Test terminal strip with PT ... push-in connection, VDE type D19, for wall and DIN rail mounting

The **VDE D19** version described here is suitable as a plug-in test system for electromechanical differential protection for transformers.

- The test plugs are assembled with jumpers and contact tab lengths according to the circuit diagram
- A transparent covering hood protects the jumpers. The covering hood can only be removed by dismantling the test plug
- All VDE-specified 7, 14, and 19-pos. versions are supplied with exclusive coding for the matching test plug and blind plug
- The components are supplied pre-marked according to the VDE Directive
- Test signals can be connected with touch-proof safety test leads (CAT III and IV/1000 V according to EN 61010-031)
- The test plugs are equipped with two gray test sockets per position, for further color versions, see the range of accessories
- Additional test leads, assembled with ring and fork-type cable lugs, can be attached with test sockets
- Other VDE versions available on request

| Notes: |
|---|
| To create panel cutouts, see phoenixcontact.net/products . |
| ¹⁾ Derating curve available on request. |
| ²⁾ Rated surge voltage of 5 kV. |

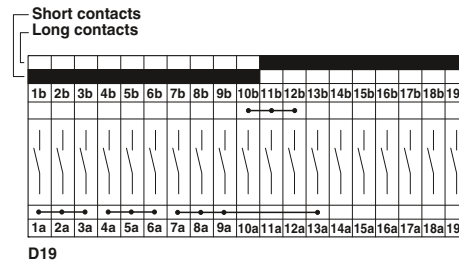

6 (10) mm², 30 A, test terminal strip, for wall mounting, VDE coded type D19

| Max. electrical data | |
|---|--|
| Rated data | |
| Rated voltage | [V] 400 ²⁾ |
| Nominal current / cross section | [A] / [mm ²] 24 ¹⁾ /6 |
| Rated cross section | [mm ²] 6 |
| Cross section range | AWG 20 - 8 |
| Connection capacity | |
| 1 conductor | [mm ²] 0.5 - 10 |
| 2 stranded conductors with a TWIN ferrule | [mm ²] 0.5 - 6 |
| Plug-in connection cross sections | [mm ²] 1 - 10 |
| General data | |
| Stripping length | [mm] 12 |
| Tightening torque for wall fastening | [Nm] 0.8 - 1 |
| Panel thickness | [mm] 1 - 4 |
| Tightening torque: test socket screw | [Nm] - |
| Insulating material | PA |
| Inflammability class according to UL 94 | V0 |

| Technical data | | | |
|---------------------|-------------------|-----------------------------|----------------|
| I_{max} [A] | U_{max} [V] | max. Ø [mm ²] | AWG |
| 30 | 400 ²⁾ | 0.5 - 10 | 20 - 8 |
| IEC 60947-7-1 | UL/CUL | CSA | IEC/EN 60079-7 |
| Connection capacity | | ferrule | |
| solid | stranded | with/without plastic sleeve | |
| 0.5 - 10 | 0.5 - 6 | 0.5 - 6 | 0.5 - 6 |
| 1 - 10 | - | 1 - 6 | 1 - 6 |

| Description | Color |
|---|-------|
| Test terminal strip , for wall mounting | gray |
| Test terminal strip , for mounting on NS 35... | gray |
| Test plug , with twist grip | gray |
| With standard handle | gray |
| Test plug , 1-pos., with cover | gray |
| Blind plug , sealable | gray |

| Ordering data | | |
|---------------------|-----------|-------------|
| Type | Order No. | Pcs. / Pkt. |
| PTWE 6-2/D19 | 3069444 | 1 |

| | |
|--|---|
| Test socket , insulated | transparent |
| | red |
| | blue |
| | yellow |
| | green |
| | violet |
| | black |
| | gray |
| | brown |
| Cover profile , supply length 1 m | transparent |
| Cover profile holder , can be snapped on and sealed | gray |
| Cover profile , supply length 1 m | transparent |
| End brackets , for AP-ME cover profile, sealable, with storage option for jumpers | gray |
| Holder , for AP-ME cover profile | gray |
| Fork-type cable lug , insulated according to UL | red |
| | blue |
| Ring cable lug , insulated according to UL | red |
| | blue |
| Screwdriver | SF-SL 0,8X4,0-100 |
| Lateral groove labeling | UC-TM 8, UCT-TM 8, ZB 8 or TMT (EX9,5)R (see Catalog 5) |

| Accessories | | |
|---|---------|----|
| AP RSC-T | 3059139 | 10 |
| APH-UTWE 6-2 | 3069057 | 10 |
| SF-SL 0,8X4,0-100 | 1212551 | 10 |
| UC-TM 8, UCT-TM 8, ZB 8 or TMT (EX9,5)R (see Catalog 5) | | |



6 (10) mm², 30 A, test terminal strip, for DIN rail mounting, VDE coded type D19



24 A, test plug, bridge assignment according to circuit diagram, VDE coded type D19



Blind plug, VDE coded type D19

| Technical data | | | |
|----------------------|----------------------|-------------------------------------|----------------------|
| I _{max} [A] | U _{max} [V] | max. Ø [mm ²] | AWG |
| 30 | 400 ²) | 0.5 - 10 | 20 - 8 |
| IEC 60947-7-1 | | | |
| IEC | UL/CUL | CSA | IEC/EN 60079-7 |
| 400 ²) | - | - | - |
| 24 ¹)/6 | - | - | - |
| 6 | - | - | - |
| 20 - 8 | - | - | - |
| solid | stranded | ferrule with/without plastic sleeve | |
| 0.5 - 10 | 0.5 - 6 | 0.5 - 6 | 0.5 - 6 0.5 - 1.5 |
| 1 - 10 | - | 1 - 6 | 1 - 6 |
| 12 | - | - | - |
| - | - | - | - |
| - | - | - | - |
| - | - | - | - |
| PA | - | - | - |
| V0 | - | - | - |

| Technical data | | | |
|----------------------|----------------------|-------------------------------------|---------|
| I _{max} [A] | U _{max} [V] | max. Ø [mm ²] | AWG |
| 24 | 400 ²) | 0.5 - 2.5 | 20 - 14 |
| IEC | | | |
| UL/CUL | CSA | IEC/EN 60079-7 | |
| 400 ²) | - | - | - |
| 24/2.5 | - | - | - |
| 6 | - | - | - |
| 20 - 14 | - | - | - |
| solid | stranded | ferrule with/without plastic sleeve | |
| - | 0.5 - 2.5 | - | - |
| - | - | - | - |
| - | - | - | - |
| 0.5 - 0.6 | - | - | - |
| PA | - | - | - |
| V0 | - | - | - |

| Technical data | | | |
|----------------|----------|-------------------------------------|-----|
| | | max. Ø [mm ²] | AWG |
| | | - | - |
| IEC | | | |
| UL/CUL | CSA | IEC/EN 60079-7 | |
| - | - | - | - |
| - | - | - | - |
| - | - | - | - |
| - | - | - | - |
| solid | stranded | ferrule with/without plastic sleeve | |
| - | - | - | - |
| - | - | - | - |
| - | - | - | - |
| PA | - | - | - |
| V0 | - | - | - |

| Ordering data | | |
|---------------|-----------|-------------|
| Type | Order No. | Pcs. / Pkt. |
| PTRE 6-2/D19 | 3069457 | 1 |
| FTPR-2/D19 | 3069492 | 1 |
| FTP-2/D19 | 3069479 | 1 |
| FTP-2/1 | 3069469 | 1 |
| FBP-2/D19 | 3069671 | 1 |

| Ordering data | | |
|---------------|-----------|-------------|
| Type | Order No. | Pcs. / Pkt. |
| PTRE 6-2/D19 | 3069457 | 1 |
| FTPR-2/D19 | 3069492 | 1 |
| FTP-2/D19 | 3069479 | 1 |
| FTP-2/1 | 3069469 | 1 |
| FBP-2/D19 | 3069671 | 1 |

| Ordering data | | |
|---------------|-----------|-------------|
| Type | Order No. | Pcs. / Pkt. |
| PTRE 6-2/D19 | 3069457 | 1 |
| FTPR-2/D19 | 3069492 | 1 |
| FTP-2/D19 | 3069479 | 1 |
| FTP-2/1 | 3069469 | 1 |
| FBP-2/D19 | 3069671 | 1 |

| Accessories | | | |
|-------------------|-------|---------|----|
| AP-ME | METER | 3034361 | 10 |
| APH-ME | | 3034374 | 10 |
| APT-ME | | 3034358 | 10 |
| SF-SL 0,8X4,0-100 | | 1212551 | 10 |

| Accessories | | | |
|---------------------|--|---------|-----|
| PSBJ-URTK 6 FARBLOS | | 3026450 | 10 |
| PSBJ-URTK 6 RD | | 3026719 | 10 |
| PSBJ-URTK 6 BU | | 3026434 | 10 |
| PSBJ-URTK 6 YE | | 3026405 | 10 |
| PSBJ-URTK 6 GN | | 3026418 | 10 |
| PSBJ-URTK 6 VT | | 3026421 | 10 |
| PSBJ-URTK 6 BK | | 3026447 | 10 |
| PSBJ-URTK 6 GY | | 3026612 | 10 |
| PSBJ-URTK 6 BN | | 3026971 | 10 |
| C-FCI 1,5/M3 | | 3240032 | 100 |
| C-FCI 2,5/M3 | | 3240037 | 100 |
| C-RCI 1,5/M3 | | 3240016 | 100 |
| C-RCI 2,5/M3 | | 3240021 | 100 |

| Accessories | | | |
|---|--|--|--|
| UC-TM 8, UCT-TM 8, ZB 8 or TMT (EX9,5)R | | | |

UC-TM 8, UCT-TM 8, ZB 8 or TMT (EX9,5)R (see Catalog 5)

UC-TM 8, UCT-TM 8, ZB 8 or TMT (EX9,5)R (see Catalog 5)

UC-TM 8, UCT-TM 8, ZB 8 or TMT (EX9,5)R (see Catalog 5)

FAME plug-in test system

Test terminal strip with PT ... push-in connection, VDE type F19, for wall and DIN rail mounting

The **VDE F19** version described here is suitable as a plug-in test system in electromechanical differential protection for transformers, generators, motors, and cables.

- The test plugs are assembled with jumpers and contact tab lengths according to the circuit diagram
- A transparent covering hood protects the jumpers. The covering hood can only be removed by dismantling the test plug
- All VDE-specified 7, 14, and 19-pos. versions are supplied with exclusive coding for the matching test plug and blind plug
- The components are supplied pre-marked according to the VDE Directive
- Test signals can be connected with touch-proof safety test leads (CAT III and IV/1000 V according to EN 61010-031)
- The test plugs are equipped with two gray test sockets per position, for further color versions, see the range of accessories
- Additional test leads, assembled with ring and fork-type cable lugs, can be attached with test sockets
- Other VDE versions available on request

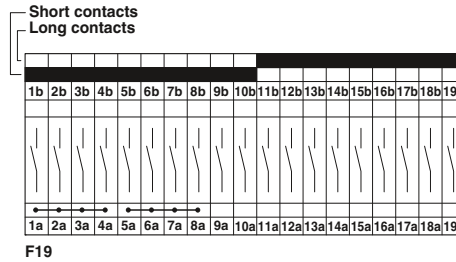

6 (10) mm², 30 A, test terminal strip, for wall mounting, VDE coded type F19

| Notes: |
|---|
| To create panel cutouts, see phoenixcontact.net/products. |
| ¹⁾ Derating curve available on request. |
| ²⁾ Rated surge voltage of 5 kV. |

| Max. electrical data | |
|---|--|
| Rated data | |
| Rated voltage | [V] 400 ²⁾ |
| Nominal current / cross section | [A] / [mm ²] 24 ¹⁾ /6 |
| Rated cross section | [mm ²] 6 |
| Cross section range | AWG 20 - 8 |
| Connection capacity | |
| 1 conductor | [mm ²] 0.5 - 10 |
| 2 stranded conductors with a TWIN ferrule | [mm ²] 0.5 - 6 |
| Plug-in connection cross sections | [mm ²] 1 - 10 |
| General data | |
| Stripping length | [mm] 12 |
| Tightening torque for wall fastening | [Nm] 0.8 - 1 |
| Panel thickness | [mm] 1 - 4 |
| Tightening torque: test socket screw | [Nm] - |
| Insulating material | PA |
| Inflammability class according to UL 94 | V0 |

| Technical data | | | |
|---|--------------------------|---------------------------------------|----------------|
| I_{max} [A] | U_{max} [V] | max. \varnothing [mm ²] | AWG |
| 30 | 400²⁾ | 0.5 - 10 | 20 - 8 |
| IEC 60947-7-1 | UL/CUL | CSA | IEC/EN 60079-7 |
| Rated data | | | |
| Rated voltage | [V] | | |
| Nominal current / cross section | [A] / [mm ²] | | |
| Rated cross section | [mm ²] | | |
| Cross section range | AWG | | |
| Connection capacity | | | |
| 1 conductor | [mm ²] | | |
| 2 stranded conductors with a TWIN ferrule | [mm ²] | | |
| Plug-in connection cross sections | [mm ²] | | |
| General data | | | |
| Stripping length | [mm] | | |
| Tightening torque for wall fastening | [Nm] | | |
| Panel thickness | [mm] | | |
| Tightening torque: test socket screw | [Nm] | | |
| Insulating material | | | |
| Inflammability class according to UL 94 | | | |

| Description | Color |
|---|-------|
| Test terminal strip , for wall mounting | gray |
| Test terminal strip , for mounting on NS 35... | gray |
| Test plug , with twist grip | gray |
| With standard handle | gray |
| Test plug , 1-pos., with cover | gray |
| Blind plug , sealable | gray |

| | |
|--|---|
| Test socket , insulated | transparent |
| | red |
| | blue |
| | yellow |
| | green |
| | violet |
| | black |
| | gray |
| | brown |
| Cover profile , supply length 1 m | transparent |
| Cover profile holder , can be snapped on and sealed | gray |
| Cover profile , supply length 1 m | transparent |
| End brackets , for AP-ME cover profile, sealable, with storage option for jumpers | gray |
| Holder , for AP-ME cover profile | gray |
| Fork-type cable lug , insulated according to UL | red |
| | blue |
| Ring cable lug , insulated according to UL | red |
| | blue |
| Screwdriver | SF-SL 0,8X4,0-100 |
| Lateral groove labeling | UC-TM 8, UCT-TM 8, ZB 8 or TMT (EX9,5)R (see Catalog 5) |

| Ordering data | | |
|---------------------|----------------|-------------|
| Type | Order No. | Pcs. / Pkt. |
| PTWE 6-2/F19 | 3069445 | 1 |

| Accessories | | |
|--|----------------|-------------|
| Type | Order No. | Pcs. / Pkt. |
| AP RSC-T | 3059139 | 10 |
| APH-UTWE 6-2 | 3069057 | 10 |
| SF-SL 0,8X4,0-100 | 1212551 | 10 |
| UC-TM 8, UCT-TM 8, ZB 8 or TMT (EX9,5)R (see Catalog 5) | | |



6 (10) mm², 30 A, test terminal strip, for DIN rail mounting, VDE coded type F19



24 A, test plug, bridge assignment according to circuit diagram, VDE coded type F19



Blind plug, VDE coded type F19

| Technical data | | | |
|----------------------|----------------------|-------------------------------------|----------------------|
| I _{max} [A] | U _{max} [V] | max. Ø [mm ²] | AWG |
| 30 | 400 ²) | 0.5 - 10 | 20 - 8 |
| IEC 60947-7-1 | | | |
| IEC | UL/CUL | CSA | IEC/EN 60079-7 |
| 400 ²) | - | - | - |
| 24 ¹)/6 | - | - | - |
| 6 | - | - | - |
| 20 - 8 | - | - | - |
| solid | stranded | ferrule with/without plastic sleeve | |
| 0.5 - 10 | 0.5 - 6 | 0.5 - 6 | 0.5 - 6 0.5 - 1.5 |
| 1 - 10 | - | 1 - 6 | 1 - 6 |
| 12 | - | - | - |
| - | - | - | - |
| - | - | - | - |
| - | - | - | - |
| PA | - | - | - |
| V0 | - | - | - |

| Technical data | | | |
|----------------------|----------------------|-------------------------------------|---------|
| I _{max} [A] | U _{max} [V] | max. Ø [mm ²] | AWG |
| 24 | 400 ²) | 0.5 - 2.5 | 20 - 14 |
| IEC | | | |
| UL/CUL | CSA | IEC/EN 60079-7 | |
| 400 ²) | - | - | - |
| 24/2.5 | - | - | - |
| 6 | - | - | - |
| 20 - 14 | - | - | - |
| solid | stranded | ferrule with/without plastic sleeve | |
| - | 0.5 - 2.5 | - | - |
| - | - | - | - |
| - | - | - | - |
| 0.5 - 0.6 | - | - | - |
| PA | - | - | - |
| V0 | - | - | - |

| Technical data | | | |
|----------------|----------|-------------------------------------|-----|
| | | max. Ø [mm ²] | AWG |
| | | - | - |
| IEC | | | |
| UL/CUL | CSA | IEC/EN 60079-7 | |
| - | - | - | - |
| - | - | - | - |
| - | - | - | - |
| - | - | - | - |
| solid | stranded | ferrule with/without plastic sleeve | |
| - | - | - | - |
| - | - | - | - |
| - | - | - | - |
| PA | - | - | - |
| V0 | - | - | - |

| Ordering data | | |
|---------------|-----------|-------------|
| Type | Order No. | Pcs. / Pkt. |
| PTRE 6-2/F19 | 3069458 | 1 |
| FTP-2/F19 | 3069493 | 1 |
| FTP-2/1 | 3069469 | 1 |

| Ordering data | | |
|---------------|-----------|-------------|
| Type | Order No. | Pcs. / Pkt. |
| FTP-2/F19 | 3069493 | 1 |
| FTP-2/1 | 3069469 | 1 |

| Ordering data | | |
|---------------|-----------|-------------|
| Type | Order No. | Pcs. / Pkt. |
| FBP-2/F19 | 3069675 | 1 |

| Accessories | | | |
|-------------|-------------|---------|----|
| AP-ME | METER | 3034361 | 10 |
| APH-ME | | 3034374 | 10 |
| APT-ME | | 3034358 | 10 |
| SF-SL | 0,8X4,0-100 | 1212551 | 10 |

| Accessories | | | |
|---------------------|--|---------|-----|
| PSBJ-URTK 6 FARBLOS | | 3026450 | 10 |
| PSBJ-URTK 6 RD | | 3026719 | 10 |
| PSBJ-URTK 6 BU | | 3026434 | 10 |
| PSBJ-URTK 6 YE | | 3026405 | 10 |
| PSBJ-URTK 6 GN | | 3026418 | 10 |
| PSBJ-URTK 6 VT | | 3026421 | 10 |
| PSBJ-URTK 6 BK | | 3026447 | 10 |
| PSBJ-URTK 6 GY | | 3026612 | 10 |
| PSBJ-URTK 6 BN | | 3026971 | 10 |
| C-FCI 1,5/M3 | | 3240032 | 100 |
| C-FCI 2,5/M3 | | 3240037 | 100 |
| C-RCI 1,5/M3 | | 3240016 | 100 |
| C-RCI 2,5/M3 | | 3240021 | 100 |

| Accessories | | | |
|---|-----------------|--|--|
| UC-TM 8, UCT-TM 8, ZB 8 or TMT (EX9,5)R | (see Catalog 5) | | |

UC-TM 8, UCT-TM 8, ZB 8 or TMT (EX9,5)R (see Catalog 5)

UC-TM 8, UCT-TM 8, ZB 8 or TMT (EX9,5)R (see Catalog 5)

UC-TM 8, UCT-TM 8, ZB 8 or TMT (EX9,5)R (see Catalog 5)

FAME plug-in test system

Test terminal strip with PT ... push-in connection, VDE type G19, for wall and DIN rail mounting

The **VDE G19** version described here is suitable as a plug-in test system in digital differential protection for transformers.

- The test plugs are assembled with jumpers and contact tab lengths according to the circuit diagram
- A transparent covering hood protects the jumpers. The covering hood can only be removed by dismantling the test plug
- All VDE-specified 7, 14, and 19-pos. versions are supplied with exclusive coding for the matching test plug and blind plug
- The components are supplied pre-marked according to the VDE Directive
- Test signals can be connected with touch-proof safety test leads (CAT III and IV/1000 V according to EN 61010-031)
- The test plugs are equipped with two gray test sockets per position, for further color versions, see the range of accessories
- Additional test leads, assembled with ring and fork-type cable lugs, can be attached with test sockets
- Other VDE versions available on request

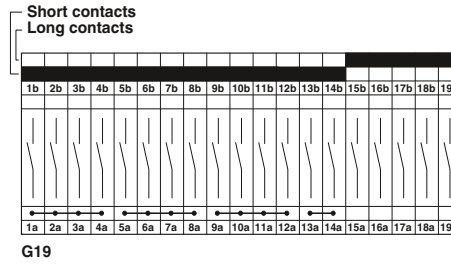

6 (10) mm², 30 A, test terminal strip, for wall mounting, VDE coded type G19

| Notes: | |
|---|--|
| To create panel cutouts, see phoenixcontact.net/products . | |
| 1) Derating curve available on request. | |
| 2) Rated surge voltage of 5 kV. | |

| Max. electrical data | |
|---|--|
| Rated voltage | [V] 400 ²⁾ |
| Nominal current / cross section | [A] / [mm ²] 24 ¹⁾ /6 |
| Rated cross section | [mm ²] 6 |
| Cross section range | AWG 20 - 8 |
| Connection capacity | |
| 1 conductor | [mm ²] 0.5 - 10 |
| 2 stranded conductors with a TWIN ferrule | [mm ²] 0.5 - 6 |
| Plug-in connection cross sections | [mm ²] 1 - 10 |
| General data | |
| Stripping length | [mm] 12 |
| Tightening torque for wall fastening | [Nm] 0.8 - 1 |
| Panel thickness | [mm] 1 - 4 |
| Tightening torque: test socket screw | [Nm] - |
| Insulating material | PA |
| Inflammability class according to UL 94 | V0 |

| Technical data | | | |
|----------------------|----------------------|-----------------------------|----------------|
| I _{max} [A] | U _{max} [V] | max. Ø [mm ²] | AWG |
| 30 | 400 ²⁾ | 0.5 - 10 | 20 - 8 |
| IEC 60947-7-1 | UL/CUL | CSA | IEC/EN 60079-7 |
| Connection capacity | | ferrule | |
| solid | stranded | with/without plastic sleeve | |
| 0.5 - 10 | 0.5 - 6 | 0.5 - 6 | 0.5 - 6 |
| | | 1 - 4 | 0.5 - 1.5 |
| 1 - 10 | - | 1 - 6 | 1 - 6 |

| Description | Color |
|---|-------|
| Test terminal strip, for wall mounting | gray |
| Test terminal strip, for mounting on NS 35... | gray |
| Test plug, with twist grip | gray |
| With standard handle | gray |
| Test plug, 1-pos., with cover | gray |
| Blind plug, sealable | gray |

| | |
|--|---|
| Test socket, insulated | transparent |
| | red |
| | blue |
| | yellow |
| | green |
| | violet |
| | black |
| | gray |
| | brown |
| Cover profile, supply length 1 m | transparent |
| Cover profile holder, can be snapped on and sealed | gray |
| Cover profile, supply length 1 m | transparent |
| End brackets, for AP-ME cover profile, sealable, with storage option for jumpers | gray |
| Holder, for AP-ME cover profile | gray |
| Fork-type cable lug, insulated according to UL | red |
| | blue |
| Ring cable lug, insulated according to UL | red |
| | blue |
| Screwdriver | SF-SL 0,8X4,0-100 |
| Lateral groove labeling | UC-TM 8, UCT-TM 8, ZB 8 or TMT (EX9,5)R (see Catalog 5) |

| Ordering data | | |
|---------------|-----------|-------------|
| Type | Order No. | Pcs. / Pkt. |
| PTWE 6-2/G19 | 3069446 | 1 |

| Accessories | | |
|---|-----------|-------------|
| Type | Order No. | Pcs. / Pkt. |
| AP RSC-T | 3059139 | 10 |
| APH-UTWE 6-2 | 3069057 | 10 |
| SF-SL 0,8X4,0-100 | 1212551 | 10 |
| UC-TM 8, UCT-TM 8, ZB 8 or TMT (EX9,5)R (see Catalog 5) | | |



6 (10) mm², 30 A, test terminal strip, for DIN rail mounting, VDE coded type G19



24 A, test plug, bridge assignment according to circuit diagram, VDE coded type G19



Blind plug, VDE coded type G19

| Technical data | | | |
|----------------------|----------------------|-------------------------------------|----------------------|
| I _{max} [A] | U _{max} [V] | max. Ø [mm ²] | AWG |
| 30 | 400 ²) | 0.5 - 10 | 20 - 8 |
| IEC 60947-7-1 | | | |
| IEC | UL/CUL | CSA | IEC/EN 60079-7 |
| 400 ²) | - | - | - |
| 24 ¹)/6 | - | - | - |
| 6 | - | - | - |
| 20 - 8 | - | - | - |
| solid | stranded | ferrule with/without plastic sleeve | |
| 0.5 - 10 | 0.5 - 6 | 0.5 - 6 | 0.5 - 6 0.5 - 1.5 |
| 1 - 10 | - | 1 - 6 | 1 - 6 |
| 12 | - | - | - |
| - | - | - | - |
| - | - | - | - |
| PA | - | - | - |
| V0 | - | - | - |

| Technical data | | | |
|----------------------|----------------------|-------------------------------------|---------|
| I _{max} [A] | U _{max} [V] | max. Ø [mm ²] | AWG |
| 24 | 400 ²) | 0.5 - 2.5 | 20 - 14 |
| IEC | | | |
| UL/CUL | CSA | IEC/EN 60079-7 | |
| 400 ²) | - | - | - |
| 24/2.5 | - | - | - |
| 6 | - | - | - |
| 20 - 14 | - | - | - |
| solid | stranded | ferrule with/without plastic sleeve | |
| - | 0.5 - 2.5 | - | - |
| - | - | - | - |
| 0.5 - 0.6 | - | - | - |
| PA | - | - | - |
| V0 | - | - | - |

| Technical data | | | |
|----------------|----------|-------------------------------------|-----|
| | | max. Ø [mm ²] | AWG |
| | | - | - |
| IEC | | | |
| UL/CUL | CSA | IEC/EN 60079-7 | |
| - | - | - | - |
| - | - | - | - |
| - | - | - | - |
| - | - | - | - |
| solid | stranded | ferrule with/without plastic sleeve | |
| - | - | - | - |
| - | - | - | - |
| PA | - | - | - |
| V0 | - | - | - |

| Ordering data | | |
|---------------|-----------|-------------|
| Type | Order No. | Pcs. / Pkt. |
| PTRE 6-2/G19 | 3069459 | 1 |
| FTP-2/G19 | 3069494 | 1 |
| FTP-2/G19 | 3069481 | 1 |
| FTP-2/1 | 3069469 | 1 |
| FBP-2/G19 | 3069676 | 1 |

| Ordering data | | |
|---------------|-----------|-------------|
| Type | Order No. | Pcs. / Pkt. |
| FTP-2/G19 | 3069494 | 1 |
| FTP-2/G19 | 3069481 | 1 |
| FTP-2/1 | 3069469 | 1 |
| FBP-2/G19 | 3069676 | 1 |

| Ordering data | | |
|---------------|-----------|-------------|
| Type | Order No. | Pcs. / Pkt. |
| FBP-2/G19 | 3069676 | 1 |

| Accessories | | | |
|-------------------|-------|---------|----|
| AP-ME | METER | 3034361 | 10 |
| APH-ME | | 3034374 | 10 |
| APT-ME | | 3034358 | 10 |
| SF-SL 0,8X4,0-100 | | 1212551 | 10 |

| Accessories | | | |
|---------------------|--|---------|-----|
| PSBJ-URTK 6 FARBLOS | | 3026450 | 10 |
| PSBJ-URTK 6 RD | | 3026719 | 10 |
| PSBJ-URTK 6 BU | | 3026434 | 10 |
| PSBJ-URTK 6 YE | | 3026405 | 10 |
| PSBJ-URTK 6 GN | | 3026418 | 10 |
| PSBJ-URTK 6 VT | | 3026421 | 10 |
| PSBJ-URTK 6 BK | | 3026447 | 10 |
| PSBJ-URTK 6 GY | | 3026612 | 10 |
| PSBJ-URTK 6 BN | | 3026971 | 10 |
| C-FCI 1,5/M3 | | 3240032 | 100 |
| C-FCI 2,5/M3 | | 3240037 | 100 |
| C-RCI 1,5/M3 | | 3240016 | 100 |
| C-RCI 2,5/M3 | | 3240021 | 100 |

| Accessories | | | |
|---|--|--|--|
| UC-TM 8, UCT-TM 8, ZB 8 or TMT (EX9,5)R | | | |

UC-TM 8, UCT-TM 8, ZB 8 or TMT (EX9,5)R (see Catalog 5)

UC-TM 8, UCT-TM 8, ZB 8 or TMT (EX9,5)R (see Catalog 5)

UC-TM 8, UCT-TM 8, ZB 8 or TMT (EX9,5)R (see Catalog 5)

FAME plug-in test system

Test terminal strip with PT ... push-in connection, VDE type H19, for wall and DIN rail mounting

The **VDE H19** version described here is suitable as a plug-in test system in overcurrent directional protection and distance protection as system protection.

- The test plugs are assembled with jumpers and contact tab lengths according to the circuit diagram
- A transparent covering hood protects the jumpers. The covering hood can only be removed by dismantling the test plug
- All VDE-specified 7, 14, and 19-pos. versions are supplied with exclusive coding for the matching test plug and blind plug
- The components are supplied pre-marked according to the VDE Directive
- Test signals can be connected with touch-proof safety test leads (CAT III and IV/1000 V according to EN 61010-031)
- The test plugs are equipped with two gray test sockets per position, for further color versions, see the range of accessories
- Additional test leads, assembled with ring and fork-type cable lugs, can be attached with test sockets
- Other VDE versions available on request

Notes:

To create panel cutouts, see phoenixcontact.net/products.

¹⁾ Derating curve available on request.

²⁾ Rated surge voltage of 5 kV.

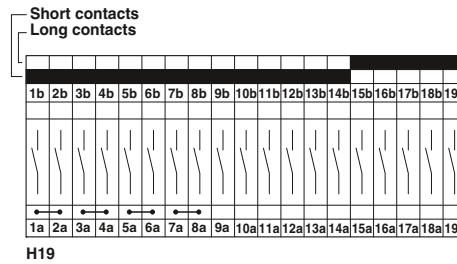

Max. electrical data

Rated data

| | | |
|---------------------------------|--------------------------|---------------------|
| Rated voltage | [V] | 400 ²⁾ |
| Nominal current / cross section | [A] / [mm ²] | 24 ¹⁾ /6 |
| Rated cross section | [mm ²] | 6 |
| Cross section range | AWG | 20 - 8 |

Connection capacity

| | | |
|---|--------------------|----------|
| 1 conductor | [mm ²] | 0.5 - 10 |
| 2 stranded conductors with a TWIN ferrule | [mm ²] | 0.5 - 6 |
| Plug-in connection cross sections | [mm ²] | 1 - 10 |

General data

| | | |
|---|------|---------|
| Stripping length | [mm] | 12 |
| Tightening torque for wall fastening | [Nm] | 0.8 - 1 |
| Panel thickness | [mm] | 1 - 4 |
| Tightening torque: test socket screw | [Nm] | - |
| Insulating material | | PA |
| Inflammability class according to UL 94 | | V0 |

| Description | Color |
|---|-------|
| Test terminal strip , for wall mounting | gray |
| Test terminal strip , for mounting on NS 35... | gray |
| Test plug , with twist grip | gray |
| With standard handle | gray |
| Test plug , 1-pos., with cover | gray |
| Blind plug , sealable | gray |

| | |
|--|---|
| Test socket , insulated | transparent red blue yellow green violet black gray brown |
| Cover profile , supply length 1 m | transparent |
| Cover profile holder , can be snapped on and sealed | gray |
| Cover profile , supply length 1 m | transparent |
| End brackets , for AP-ME cover profile, sealable, with storage option for jumpers | gray |
| Holder , for AP-ME cover profile | gray |
| Fork-type cable lug , insulated according to UL | red blue |
| Ring cable lug , insulated according to UL | red blue |

Screwdriver

Lateral groove labeling



6 (10) mm², 30 A, test terminal strip, for wall mounting, VDE coded type H19

Technical data

| I _{max} [A] | U _{max} [V] | max. Ø [mm ²] | AWG |
|---|--------------------------|-----------------------------|----------------|
| 30 | 400²⁾ | 0.5 - 10 | 20 - 8 |
| IEC 60947-7-1 | UL/CUL | CSA | IEC/EN 60079-7 |
| Rated data | | Connection capacity | |
| Rated voltage | [V] | ferrule | |
| Nominal current / cross section | [A] / [mm ²] | with/without plastic sleeve | |
| Rated cross section | [mm ²] | 0.5 - 6 | 0.5 - 6 |
| Cross section range | AWG | - | 0.5 - 1.5 |
| Connection capacity | | 1 - 10 | 1 - 6 |
| 1 conductor | [mm ²] | - | - |
| 2 stranded conductors with a TWIN ferrule | [mm ²] | - | - |
| Plug-in connection cross sections | [mm ²] | 1 - 10 | 1 - 6 |
| General data | | | |
| Stripping length | [mm] | 12 | |
| Tightening torque for wall fastening | [Nm] | 0.8 - 1 | |
| Panel thickness | [mm] | 1 - 4 | |
| Tightening torque: test socket screw | [Nm] | - | |
| Insulating material | | PA | |
| Inflammability class according to UL 94 | | V0 | |

Ordering data

| Type | Order No. | Pcs. / Pkt. |
|---------------------|----------------|-------------|
| PTWE 6-2/H19 | 3069447 | 1 |

Accessories

| | | |
|--|----------------|-----------|
| AP RSC-T | 3059139 | 10 |
| APH-UTWE 6-2 | 3069057 | 10 |
| SF-SL 0,8X4,0-100 | 1212551 | 10 |
| UC-TM 8, UCT-TM 8, ZB 8 or TMT (EX9,5)R (see Catalog 5) | | |



6 (10) mm², 30 A, test terminal strip, for DIN rail mounting, VDE coded type H19



24 A, test plug, bridge assignment according to circuit diagram, VDE coded type H19



Blind plug, VDE coded type H19

| Technical data | | | |
|----------------------|----------------------|-------------------------------------|----------------------|
| I _{max} [A] | U _{max} [V] | max. Ø [mm ²] | AWG |
| 30 | 400 ²) | 0.5 - 10 | 20 - 8 |
| IEC 60947-7-1 | | | |
| IEC | UL/CUL | CSA | IEC/EN 60079-7 |
| 400 ²) | - | - | - |
| 24 ¹)/6 | - | - | - |
| 6 | - | - | - |
| 20 - 8 | - | - | - |
| solid | stranded | ferrule with/without plastic sleeve | |
| 0.5 - 10 | 0.5 - 6 | 0.5 - 6 | 0.5 - 6 0.5 - 1.5 |
| 1 - 10 | - | 1 - 6 | 1 - 6 |
| 12 | - | - | - |
| - | - | - | - |
| - | - | - | - |
| - | - | - | - |
| PA | - | - | - |
| V0 | - | - | - |

| Technical data | | | |
|----------------------|----------------------|-------------------------------------|---------|
| I _{max} [A] | U _{max} [V] | max. Ø [mm ²] | AWG |
| 24 | 400 ²) | 0.5 - 2.5 | 20 - 14 |
| IEC | | | |
| UL/CUL | CSA | IEC/EN 60079-7 | |
| 400 ²) | - | - | - |
| 24/2.5 | - | - | - |
| 6 | - | - | - |
| 20 - 14 | - | - | - |
| solid | stranded | ferrule with/without plastic sleeve | |
| - | 0.5 - 2.5 | - | - |
| - | - | - | - |
| - | - | - | - |
| 0.5 - 0.6 | - | - | - |
| PA | - | - | - |
| V0 | - | - | - |

| Technical data | | | |
|----------------|----------|-------------------------------------|-----|
| | | max. Ø [mm ²] | AWG |
| | | - | - |
| IEC | | | |
| UL/CUL | CSA | IEC/EN 60079-7 | |
| - | - | - | - |
| - | - | - | - |
| - | - | - | - |
| - | - | - | - |
| solid | stranded | ferrule with/without plastic sleeve | |
| - | - | - | - |
| - | - | - | - |
| - | - | - | - |
| PA | - | - | - |
| V0 | - | - | - |

| Ordering data | | |
|---------------|-----------|-------------|
| Type | Order No. | Pcs. / Pkt. |
| PTRE 6-2/H19 | 3069460 | 1 |
| FTP-2/H19 | 3069495 | 1 |
| FTP-2/H19 | 3069482 | 1 |
| FTP-2/1 | 3069469 | 1 |

| Ordering data | | |
|---------------|-----------|-------------|
| Type | Order No. | Pcs. / Pkt. |
| FBP-2/H19 | 3069677 | 1 |

| Ordering data | | |
|---------------|-----------|-------------|
| Type | Order No. | Pcs. / Pkt. |
| FBP-2/H19 | 3069677 | 1 |

| Accessories | | | |
|-------------|-------------|---------|----|
| AP-ME | METER | 3034361 | 10 |
| APH-ME | | 3034374 | 10 |
| APT-ME | | 3034358 | 10 |
| SF-SL | 0,8X4,0-100 | 1212551 | 10 |

| Accessories | | | |
|---------------------|--|---------|-----|
| PSBJ-URTK 6 FARBLOS | | 3026450 | 10 |
| PSBJ-URTK 6 RD | | 3026719 | 10 |
| PSBJ-URTK 6 BU | | 3026434 | 10 |
| PSBJ-URTK 6 YE | | 3026405 | 10 |
| PSBJ-URTK 6 GN | | 3026418 | 10 |
| PSBJ-URTK 6 VT | | 3026421 | 10 |
| PSBJ-URTK 6 BK | | 3026447 | 10 |
| PSBJ-URTK 6 GY | | 3026612 | 10 |
| PSBJ-URTK 6 BN | | 3026971 | 10 |
| C-FCI 1,5/M3 | | 3240032 | 100 |
| C-FCI 2,5/M3 | | 3240037 | 100 |
| C-RCI 1,5/M3 | | 3240016 | 100 |
| C-RCI 2,5/M3 | | 3240021 | 100 |

| Accessories | | | |
|---|--|--|--|
| UC-TM 8, UCT-TM 8, ZB 8 or TMT (EX9,5)R | | | |

UC-TM 8, UCT-TM 8, ZB 8 or TMT (EX9,5)R (see Catalog 5)

UC-TM 8, UCT-TM 8, ZB 8 or TMT (EX9,5)R (see Catalog 5)

UC-TM 8, UCT-TM 8, ZB 8 or TMT (EX9,5)R (see Catalog 5)

FAME plug-in test system

Test terminal strip with PT ... push-in connection, VDE type I19, for wall and DIN rail mounting

The **VDE I19** version described here is suitable as a plug-in test system in medium voltage, outlet, and coupling protection, including selective ground fault detection.

- The test plugs are assembled with jumpers and contact tab lengths according to the circuit diagram
- A transparent covering hood protects the jumpers. The covering hood can only be removed by dismantling the test plug
- All VDE-specified 7, 14, and 19-pos. versions are supplied with exclusive coding for the matching test plug and blind plug
- The components are supplied pre-marked according to the VDE Directive
- Test signals can be connected with touch-proof safety test leads (CAT III and IV/1000 V according to EN 61010-031)
- The test plugs are equipped with two gray test sockets per position, for further color versions, see the range of accessories
- Additional test leads, assembled with ring and fork-type cable lugs, can be attached with test sockets
- Other VDE versions available on request

| Notes: |
|---|
| To create panel cutouts, see phoenixcontact.net/products . |
| ¹⁾ Derating curve available on request. |
| ²⁾ Rated surge voltage of 5 kV. |

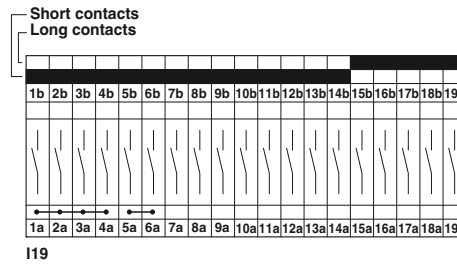

| Max. electrical data | |
|---|--|
| Rated data | |
| Rated voltage | [V] 400 ²⁾ |
| Nominal current / cross section | [A] / [mm ²] 24 ¹⁾ /6 |
| Rated cross section | [mm ²] 6 |
| Cross section range | AWG 20 - 8 |
| Connection capacity | |
| 1 conductor | [mm ²] 0.5 - 10 |
| 2 stranded conductors with a TWIN ferrule | [mm ²] 0.5 - 6 |
| Plug-in connection cross sections | [mm ²] 1 - 10 |
| General data | |
| Stripping length | [mm] 12 |
| Tightening torque for wall fastening | [Nm] 0.8 - 1 |
| Panel thickness | [mm] 1 - 4 |
| Tightening torque: test socket screw | [Nm] - |
| Insulating material | PA |
| Inflammability class according to UL 94 | V0 |

| Description | Color |
|---|-------|
| Test terminal strip , for wall mounting | gray |
| Test terminal strip , for mounting on NS 35... | gray |
| Test plug , with twist grip | gray |
| With standard handle | gray |
| Test plug , 1-pos., with cover | gray |
| Blind plug , sealable | gray |

| | |
|--|---|
| Test socket , insulated | transparent red blue yellow green violet black gray brown |
| Cover profile , supply length 1 m | transparent |
| Cover profile holder , can be snapped on and sealed | gray |
| Cover profile , supply length 1 m | transparent |
| End brackets , for AP-ME cover profile, sealable, with storage option for jumpers | gray |
| Holder , for AP-ME cover profile | gray |
| Fork-type cable lug , insulated according to UL | red blue |
| Ring cable lug , insulated according to UL | red blue |
| Screwdriver | SF-SL 0,8X4,0-100 |
| Lateral groove labeling | UC-TM 8, UCT-TM 8, ZB 8 or TMT (EX9,5)R (see Catalog 5) |



6 (10) mm², 30 A, test terminal strip, for wall mounting, VDE coded type I19

| Technical data | | | |
|----------------------|----------------------|-----------------------------|----------------|
| I _{max} [A] | U _{max} [V] | max. Ø [mm ²] | AWG |
| 30 | 400 ²⁾ | 0.5 - 10 | 20 - 8 |
| IEC 60947-7-1 | UL/CUL | CSA | IEC/EN 60079-7 |
| Connection capacity | | ferrule | |
| solid | stranded | with/without plastic sleeve | |
| 0.5 - 10 | 0.5 - 6 | 0.5 - 6 | 0.5 - 6 |
| 1 - 10 | - | 1 - 6 | 1 - 6 |

| Ordering data | | |
|---------------------|-----------|-------------|
| Type | Order No. | Pcs. / Pkt. |
| PTWE 6-2/I19 | 3069448 | 1 |

| Accessories | | |
|--|---------|----|
| AP RSC-T | 3059139 | 10 |
| APH-UTWE 6-2 | 3069057 | 10 |
| SF-SL 0,8X4,0-100 | 1212551 | 10 |
| UC-TM 8, UCT-TM 8, ZB 8 or TMT (EX9,5)R (see Catalog 5) | | |



6 (10) mm², 30 A, test terminal strip, for DIN rail mounting, VDE coded type I19



24 A, test plug, bridge assignment according to circuit diagram, VDE coded type I19



Blind plug, VDE coded type I19

| Technical data | | | |
|----------------------|----------------------|-------------------------------------|----------------------|
| I _{max} [A] | U _{max} [V] | max. Ø [mm ²] | AWG |
| 30 | 400 ²) | 0.5 - 10 | 20 - 8 |
| IEC 60947-7-1 | | | |
| IEC | UL/CUL | CSA | IEC/EN 60079-7 |
| 400 ²) | - | - | - |
| 24 ¹)/6 | - | - | - |
| 6 | - | - | - |
| 20 - 8 | - | - | - |
| solid | stranded | ferrule with/without plastic sleeve | |
| 0.5 - 10 | 0.5 - 6 | 0.5 - 6 | 0.5 - 6 0.5 - 1.5 |
| 1 - 10 | - | 1 - 6 | 1 - 6 |
| 12 | - | - | - |
| - | - | - | - |
| - | - | - | - |
| - | - | - | - |
| PA | - | - | - |
| V0 | - | - | - |

| Technical data | | | |
|----------------------|----------------------|-------------------------------------|---------|
| I _{max} [A] | U _{max} [V] | max. Ø [mm ²] | AWG |
| 24 | 400 ²) | 0.5 - 2.5 | 20 - 14 |
| IEC | | | |
| UL/CUL | CSA | IEC/EN 60079-7 | |
| 400 ²) | - | - | - |
| 24/2.5 | - | - | - |
| 6 | - | - | - |
| 20 - 14 | - | - | - |
| solid | stranded | ferrule with/without plastic sleeve | |
| - | 0.5 - 2.5 | - | - |
| - | - | - | - |
| - | - | - | - |
| 0.5 - 0.6 | - | - | - |
| PA | - | - | - |
| V0 | - | - | - |

| Technical data | | | |
|----------------|----------|-------------------------------------|-----|
| | | max. Ø [mm ²] | AWG |
| | | - | - |
| IEC | | | |
| UL/CUL | CSA | IEC/EN 60079-7 | |
| - | - | - | - |
| - | - | - | - |
| - | - | - | - |
| - | - | - | - |
| solid | stranded | ferrule with/without plastic sleeve | |
| - | - | - | - |
| - | - | - | - |
| - | - | - | - |
| PA | - | - | - |
| V0 | - | - | - |

| Ordering data | | |
|---------------|-----------|-------------|
| Type | Order No. | Pcs. / Pkt. |
| PTRE 6-2/I19 | 3069461 | 1 |
| FTP-2/I19 | 3069496 | 1 |
| FTP-2/1 | 3069483 | 1 |
| FTP-2/1 | 3069469 | 1 |

| Ordering data | | |
|---------------|-----------|-------------|
| Type | Order No. | Pcs. / Pkt. |
| FTP-2/I19 | 3069496 | 1 |
| FTP-2/1 | 3069483 | 1 |
| FTP-2/1 | 3069469 | 1 |

| Ordering data | | |
|---------------|-----------|-------------|
| Type | Order No. | Pcs. / Pkt. |
| FBP-2/I19 | 3069678 | 1 |

| Accessories | | | |
|-------------------|-------|---------|----|
| AP-ME | METER | 3034361 | 10 |
| APH-ME | | 3034374 | 10 |
| APT-ME | | 3034358 | 10 |
| SF-SL 0,8X4,0-100 | | 1212551 | 10 |

| Accessories | | | |
|---------------------|--|---------|-----|
| PSBJ-URTK 6 FARBLOS | | 3026450 | 10 |
| PSBJ-URTK 6 RD | | 3026719 | 10 |
| PSBJ-URTK 6 BU | | 3026434 | 10 |
| PSBJ-URTK 6 YE | | 3026405 | 10 |
| PSBJ-URTK 6 GN | | 3026418 | 10 |
| PSBJ-URTK 6 VT | | 3026421 | 10 |
| PSBJ-URTK 6 BK | | 3026447 | 10 |
| PSBJ-URTK 6 GY | | 3026612 | 10 |
| PSBJ-URTK 6 BN | | 3026971 | 10 |
| C-FCI 1,5/M3 | | 3240032 | 100 |
| C-FCI 2,5/M3 | | 3240037 | 100 |
| C-RCI 1,5/M3 | | 3240016 | 100 |
| C-RCI 2,5/M3 | | 3240021 | 100 |

| Accessories | | | |
|---|--|--|--|
| UC-TM 8, UCT-TM 8, ZB 8 or TMT (EX9,5)R | | | |

UC-TM 8, UCT-TM 8, ZB 8 or TMT (EX9,5)R (see Catalog 5)

UC-TM 8, UCT-TM 8, ZB 8 or TMT (EX9,5)R (see Catalog 5)

UC-TM 8, UCT-TM 8, ZB 8 or TMT (EX9,5)R (see Catalog 5)

FAME plug-in test system

Test terminal strip with UT ... screw connection, VDE type A7, for wall and DIN rail mounting

The **VDE A7** version described here is suitable as a plug-in test system in single-system current, voltage, and power relays, wattmetric and ground fault wiper relays, detuning level controllers or reverse power protection for generators.

- The test plugs are assembled with jumpers and contact tab lengths according to the circuit diagram
- A transparent covering hood protects the jumpers. The covering hood can only be removed by dismantling the test plug
- All VDE-specified 7, 14, and 19-pos. versions are supplied with exclusive coding for the matching test plug and blind plug
- The components are supplied pre-marked according to the VDE Directive
- Test signals can be connected with touch-proof safety test leads (CAT III and IV/1000 V according to EN 61010-031)
- The test plugs are equipped with two gray test sockets per position, for further color versions, see the range of accessories
- Additional test leads, assembled with ring and fork-type cable lugs, can be attached with test sockets
- Other VDE versions available on request

Notes:

To create panel cutouts, see phoenixcontact.net/products.

1) Derating curve available on request.

2) Rated surge voltage of 5 kV.

Long contacts
Short contacts

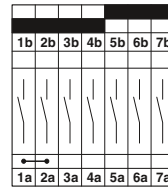

A7



6 (10) mm², 30 A, test terminal strip, for wall mounting, VDE coded type A7

Max. electrical data

30

Rated data

Rated voltage [V] 400²⁾
Nominal current / cross section [A] / [mm²] 24¹⁾/6
Rated cross section [mm²] 6
Cross section range AWG 24 - 8

Connection capacity

1 conductor [mm²] 0.2 - 10
2 conductors (of the same type) [mm²] 0.2 - 2.5
2 stranded conductors with a TWIN ferrule [mm²] 0.2 - 2.5

General data

Stripping length [mm] 10
Screw thread M4
Tightening torque [Nm] 1.5 - 1.8
Tightening torque for wall fastening [Nm] 0.8 - 1
Panel thickness [mm] 1 - 4
Tightening torque: test socket screw [Nm] -
Insulating material PA
Inflammability class according to UL 94 V0

Technical data

I_{max} [A] **30** U_{max} [V] **400²⁾** max. Ø [mm²] **0.2 - 10** AWG **24 - 8**

IEC 60947-7-1 IEC UL/CUL CSA IEC/EN 60079-7

Rated voltage [V] 400²⁾ - - -
Nominal current / cross section [A] / [mm²] 24¹⁾/6 - - -
Rated cross section [mm²] 6 - - -
Cross section range AWG 24 - 8 - - -

Connection capacity
solid stranded ferrule
with/without plastic sleeve
0.2 - 10 0.2 - 10 0.25 - 6 0.25 - 6
0.2 - 2.5 0.2 - 2.5 0.25 - 1.5 -
0.5 - 2.5

Stripping length [mm] 10
Screw thread M4
Tightening torque [Nm] 1.5 - 1.8
Tightening torque for wall fastening [Nm] 0.8 - 1
Panel thickness [mm] 1 - 4
Tightening torque: test socket screw [Nm] -
Insulating material PA
Inflammability class according to UL 94 V0

Ordering data

| Type | Order No. | Pcs. / Pkt. |
|-------------|-----------|-------------|
| UTWE 6-2/A7 | 3069410 | 1 |

Accessories

| Description | Color | Type | Order No. | Pcs. / Pkt. |
|--|---|---|-----------|-------------|
| Test terminal strip , for wall mounting | gray | UTWE 6-2/A7 | 3069410 | 1 |
| Test terminal strip , for mounting on NS 35... | gray | | | |
| Test plug , with twist grip | gray | | | |
| With standard handle | gray | | | |
| Test plug , 1-pos., with cover | gray | | | |
| Blind plug , sealable | gray | | | |
| Test socket , insulated | transparent red blue yellow green violet black gray brown | | | |
| Cover profile , supply length 1 m | transparent | AP RSC-T | 3059139 | 10 |
| Cover profile holder , can be snapped on and sealed | gray | APH-UTWE 6-2 | 3069057 | 10 |
| Cover profile , supply length 1 m | transparent | | | |
| End brackets , for AP-ME cover profile, sealable, with storage option for jumpers | gray | | | |
| Holder , for AP-ME cover profile | gray | | | |
| Fork-type cable lug , insulated according to UL | red blue | | | |
| Ring cable lug , insulated according to UL | red blue | | | |
| Screwdriver | | SF-SL 0,8X4,0-100 | 1212551 | 10 |
| Lateral groove labeling | | UC-TM 8, UCT-TM 8, ZB 8 or TMT (EX9,5)R (see Catalog 5) | | |



6 (10) mm², 30 A, test terminal strip, for DIN rail mounting, VDE coded type A7



24 A, test plug, bridge assignment according to circuit diagram, VDE coded type A7



Blind plug, VDE coded type A7

| Technical data | | | |
|----------------------|----------------------|-----------------------------|----------------|
| I _{max} [A] | U _{max} [V] | max. Ø [mm ²] | AWG |
| 30 | 400 ²⁾ | 0.2 - 10 | 24 - 8 |
| IEC 60947-7-1 | | | |
| IEC | UL/CUL | CSA | IEC/EN 60079-7 |
| 400 ²⁾ | - | - | - |
| 24 ¹⁾ /6 | - | - | - |
| 6 | - | - | - |
| 24 - 8 | - | - | - |
| solid | stranded | ferrule | |
| | | with/without plastic sleeve | |
| 0.2 - 10 | 0.2 - 10 | 0.25 - 6 | 0.25 - 6 |
| 0.2 - 2.5 | 0.2 - 2.5 | 0.25 - 1.5 | - |
| | | 0.5 - 2.5 | |
| 10 | - | - | - |
| M4 | - | - | - |
| 1.5 - 1.8 | - | - | - |
| - | - | - | - |
| - | - | - | - |
| - | - | 0.5 - 0.6 | - |
| PA | - | PA | - |
| V0 | - | V0 | - |

| Technical data | | | |
|----------------------|----------------------|-----------------------------|---------|
| I _{max} [A] | U _{max} [V] | max. Ø [mm ²] | AWG |
| 24 | 400 ²⁾ | 0.5 - 2.5 | 20 - 14 |
| IEC | | | |
| UL/CUL | CSA | IEC/EN 60079-7 | |
| 400 ²⁾ | - | - | - |
| 24/2.5 | - | - | - |
| 6 | - | - | - |
| 20 - 14 | - | - | - |
| solid | stranded | ferrule | |
| | | with/without plastic sleeve | |
| - | 0.5 - 2.5 | - | - |
| - | - | - | - |
| 10 | - | - | - |
| M4 | - | - | - |
| 1.5 - 1.8 | - | - | - |
| - | - | - | - |
| - | - | - | - |
| - | - | 0.5 - 0.6 | - |
| PA | - | PA | - |
| V0 | - | V0 | - |

| Technical data | | | |
|----------------|----------|-----------------------------|-----|
| | | max. Ø [mm ²] | AWG |
| | | - | - |
| IEC | | | |
| UL/CUL | CSA | IEC/EN 60079-7 | |
| - | - | - | - |
| - | - | - | - |
| - | - | - | - |
| - | - | - | - |
| solid | stranded | ferrule | |
| | | with/without plastic sleeve | |
| - | - | - | - |
| - | - | - | - |
| 10 | - | - | - |
| M4 | - | - | - |
| 1.5 - 1.8 | - | - | - |
| - | - | - | - |
| - | - | - | - |
| - | - | - | - |
| PA | - | PA | - |
| V0 | - | V0 | - |

| Ordering data | | |
|---------------|-----------|-------------|
| Type | Order No. | Pcs. / Pkt. |
| UTRE 6-2/A7 | 3069423 | 1 |

| Ordering data | | |
|---------------|-----------|-------------|
| Type | Order No. | Pcs. / Pkt. |
| FTPR-2/A7 | 3069484 | 1 |
| FTP-2/A7 | 3069470 | 1 |
| FTP-2/1 | 3069469 | 1 |

| Ordering data | | |
|---------------|-----------|-------------|
| Type | Order No. | Pcs. / Pkt. |
| FBP-2/A7 | 3069497 | 1 |

| Accessories | | | |
|-------------|-------------|---------|----|
| AP-ME | METER | 3034361 | 10 |
| APH-ME | | 3034374 | 10 |
| APT-ME | | 3034358 | 10 |
| SF-SL | 0,8X4,0-100 | 1212551 | 10 |

| Accessories | | | |
|---------------------|--|---------|-----|
| PSBJ-URTK 6 FARBLOS | | 3026450 | 10 |
| PSBJ-URTK 6 RD | | 3026719 | 10 |
| PSBJ-URTK 6 BU | | 3026434 | 10 |
| PSBJ-URTK 6 YE | | 3026405 | 10 |
| PSBJ-URTK 6 GN | | 3026418 | 10 |
| PSBJ-URTK 6 VT | | 3026421 | 10 |
| PSBJ-URTK 6 BK | | 3026447 | 10 |
| PSBJ-URTK 6 GY | | 3026612 | 10 |
| PSBJ-URTK 6 BN | | 3026971 | 10 |
| C-FCI 1,5/M3 | | 3240032 | 100 |
| C-FCI 2,5/M3 | | 3240037 | 100 |
| C-RCI 1,5/M3 | | 3240016 | 100 |
| C-RCI 2,5/M3 | | 3240021 | 100 |

| Accessories | | | |
|-------------|--|--|--|
|-------------|--|--|--|

UC-TM 8, UCT-TM 8, ZB 8 or TMT (EX9,5)R (see Catalog 5)

UC-TM 8, UCT-TM 8, ZB 8 or TMT (EX9,5)R (see Catalog 5)

UC-TM 8, UCT-TM 8, ZB 8 or TMT (EX9,5)R (see Catalog 5)

FAME plug-in test system

Test terminal strip with UT ... screw connection, VDE type B7, for wall and DIN rail mounting

The **VDE B7** version described here is suitable as a plug-in test system in digital differential protection as an addition to the F19 plug-in test system, see page 120.

- The test plugs are assembled with jumpers and contact tab lengths according to the circuit diagram
- A transparent covering hood protects the jumpers. The covering hood can only be removed by dismantling the test plug
- All VDE-specified 7, 14, and 19-pos. versions are supplied with exclusive coding for the matching test plug and blind plug
- The components are supplied pre-marked according to the VDE Directive
- Test signals can be connected with touch-proof safety test leads (CAT III and IV/1000 V according to EN 61010-031)
- The test plugs are equipped with two gray test sockets per position, for further color versions, see the range of accessories
- Additional test leads, assembled with ring and fork-type cable lugs, can be attached with test sockets
- Other VDE versions available on request

Notes:

To create panel cutouts, see phoenixcontact.net/products.

¹⁾ Derating curve available on request.

²⁾ Rated surge voltage of 5 kV.

Long contacts
Short contacts



6 (10) mm², 30 A, test terminal strip, for wall mounting, VDE coded type B7

| Max. electrical data | |
|---|--|
| Rated data | |
| Rated voltage | [V] 400 ²⁾ |
| Nominal current / cross section | [A] / [mm ²] 24 ¹⁾ /6 |
| Rated cross section | [mm ²] 6 |
| Cross section range | AWG 24 - 8 |
| Connection capacity | |
| 1 conductor | [mm ²] 0.2 - 10 |
| 2 conductors (of the same type) | [mm ²] 0.2 - 2.5 |
| 2 stranded conductors with a TWIN ferrule | [mm ²] 0.25 - 1.5 |
| General data | |
| Stripping length | [mm] 10 |
| Screw thread | M4 |
| Tightening torque | [Nm] 1.5 - 1.8 |
| Tightening torque for wall fastening | [Nm] 0.8 - 1 |
| Panel thickness | [mm] 1 - 4 |
| Tightening torque: test socket screw | [Nm] - |
| Insulating material | PA |
| Inflammability class according to UL 94 | V0 |

| Technical data | | | |
|---------------------|-------------------------|---------------------------------------|----------------|
| I_{max} [A] | U_{max} [V] | max. \varnothing [mm ²] | AWG |
| 30 | 400²⁾ | 0.2 - 10 | 24 - 8 |
| IEC 60947-7-1 | UL/CUL | CSA | IEC/EN 60079-7 |
| Connection capacity | | ferrule | |
| solid | stranded | with/without plastic sleeve | |
| 0.2 - 10 | 0.2 - 10 | 0.25 - 6 | 0.25 - 6 |
| 0.2 - 2.5 | 0.2 - 2.5 | 0.25 - 1.5 | - |
| | | | 0.5 - 2.5 |

| Description | Color |
|---|-------|
| Test terminal strip , for wall mounting | gray |
| Test terminal strip , for mounting on NS 35... | gray |
| Test plug , with twist grip | gray |
| With standard handle | gray |
| Test plug , 1-pos., with cover | gray |
| Blind plug , sealable | gray |

| Ordering data | | |
|--------------------|----------------|-------------|
| Type | Order No. | Pcs. / Pkt. |
| UTWE 6-2/B7 | 3069411 | 1 |

| | |
|--|---|
| Test socket , insulated | transparent red blue yellow green violet black gray brown |
| Cover profile , supply length 1 m | transparent |
| Cover profile holder , can be snapped on and sealed | gray |
| Cover profile , supply length 1 m | transparent |
| End brackets , for AP-ME cover profile, sealable, with storage option for jumpers | gray |
| Holder , for AP-ME cover profile | gray |
| Fork-type cable lug , insulated according to UL | red blue |
| Ring cable lug , insulated according to UL | red blue |

| Accessories | | |
|--------------------------|----------------|-----------|
| AP RSC-T | 3059139 | 10 |
| APH-UTWE 6-2 | 3069057 | 10 |
| SF-SL 0,8X4,0-100 | 1212551 | 10 |

| | |
|--------------------------------|--|
| Screwdriver | |
| Lateral groove labeling | |

| | |
|--|--|
| UC-TM 8, UCT-TM 8, ZB 8 or TMT (EX9,5)R (see Catalog 5) | |
|--|--|



6 (10) mm², 30 A, test terminal strip, for DIN rail mounting, VDE coded type B7



24 A, test plug, bridge assignment according to circuit diagram, VDE coded type B7



Blind plug, VDE coded type B7

| Technical data | | | |
|----------------------|----------------------|-----------------------------|----------------|
| I _{max} [A] | U _{max} [V] | max. Ø [mm ²] | AWG |
| 30 | 400 ²) | 0.2 - 10 | 24 - 8 |
| IEC 60947-7-1 | | | |
| IEC | UL/CUL | CSA | IEC/EN 60079-7 |
| 400 ²) | - | - | - |
| 24 ¹)/6 | - | - | - |
| 6 | - | - | - |
| 24 - 8 | - | - | - |
| solid | stranded | ferrule | |
| | | with/without plastic sleeve | |
| 0.2 - 10 | 0.2 - 10 | 0.25 - 6 | 0.25 - 6 |
| 0.2 - 2.5 | 0.2 - 2.5 | 0.25 - 1.5 | - |
| | | 0.5 - 2.5 | |
| 10 | - | - | - |
| M4 | - | - | - |
| 1.5 - 1.8 | - | - | - |
| - | - | - | - |
| - | - | - | - |
| - | - | - | - |
| PA | - | - | - |
| V0 | - | - | - |

| Technical data | | | |
|----------------------|----------------------|-----------------------------|---------|
| I _{max} [A] | U _{max} [V] | max. Ø [mm ²] | AWG |
| 24 | 400 ²) | 0.5 - 2.5 | 20 - 14 |
| IEC | | | |
| UL/CUL | CSA | IEC/EN 60079-7 | |
| 400 ²) | - | - | - |
| 24/2.5 | - | - | - |
| 6 | - | - | - |
| 20 - 14 | - | - | - |
| solid | stranded | ferrule | |
| | | with/without plastic sleeve | |
| - | 0.5 - 2.5 | - | - |
| - | - | - | - |
| 0.5 - 0.6 | - | - | - |
| PA | - | - | - |
| V0 | - | - | - |

| Technical data | | | |
|----------------|----------|-----------------------------|-----|
| | | max. Ø [mm ²] | AWG |
| | | - | - |
| IEC | | | |
| UL/CUL | CSA | IEC/EN 60079-7 | |
| - | - | - | - |
| - | - | - | - |
| - | - | - | - |
| - | - | - | - |
| solid | stranded | ferrule | |
| | | with/without plastic sleeve | |
| - | - | - | - |
| - | - | - | - |
| PA | - | - | - |
| V0 | - | - | - |

| Ordering data | | |
|---------------|-----------|-------------|
| Type | Order No. | Pcs. / Pkt. |
| UTRE 6-2/B7 | 3069424 | 1 |

| Ordering data | | |
|---------------|-----------|-------------|
| Type | Order No. | Pcs. / Pkt. |
| FTPR-2/B7 | 3069485 | 1 |
| FTP-2/B7 | 3069471 | 1 |
| FTP-2/1 | 3069469 | 1 |

| Ordering data | | |
|---------------|-----------|-------------|
| Type | Order No. | Pcs. / Pkt. |
| FBP-2/B7 | 3069498 | 1 |

| Accessories | | | |
|-------------|-------------|---------|----|
| AP-ME | METER | 3034361 | 10 |
| APH-ME | | 3034374 | 10 |
| APT-ME | | 3034358 | 10 |
| SF-SL | 0,8X4,0-100 | 1212551 | 10 |

| Accessories | | | |
|---------------------|--|---------|-----|
| PSBJ-URTK 6 FARBLOS | | 3026450 | 10 |
| PSBJ-URTK 6 RD | | 3026719 | 10 |
| PSBJ-URTK 6 BU | | 3026434 | 10 |
| PSBJ-URTK 6 YE | | 3026405 | 10 |
| PSBJ-URTK 6 GN | | 3026418 | 10 |
| PSBJ-URTK 6 VT | | 3026421 | 10 |
| PSBJ-URTK 6 BK | | 3026447 | 10 |
| PSBJ-URTK 6 GY | | 3026612 | 10 |
| PSBJ-URTK 6 BN | | 3026971 | 10 |
| C-FCI 1,5/M3 | | 3240032 | 100 |
| C-FCI 2,5/M3 | | 3240037 | 100 |
| C-RCI 1,5/M3 | | 3240016 | 100 |
| C-RCI 2,5/M3 | | 3240021 | 100 |

| Accessories | | | |
|-------------|--|--|--|
|-------------|--|--|--|

UC-TM 8, UCT-TM 8, ZB 8 or TMT (EX9,5)R (see Catalog 5)

UC-TM 8, UCT-TM 8, ZB 8 or TMT (EX9,5)R (see Catalog 5)

UC-TM 8, UCT-TM 8, ZB 8 or TMT (EX9,5)R (see Catalog 5)

FAME plug-in test system

Test terminal strip with UT ... screw connection, VDE type E7, for wall and DIN rail mounting

The **VDE E7** version described here is suitable as a plug-in test system for single-stage automatic frequency load shedding (AFLS) and as rotor ground fault protection.

- The test plugs are assembled according to the circuit diagram
- A transparent covering hood protects the jumpers. The covering hood can only be removed by dismantling the test plug
- All VDE-specified 7, 14, and 19-pos. versions are supplied with exclusive coding for the matching test plug and blind plug
- The components are supplied pre-marked according to the VDE Directive
- Test signals can be connected with touch-proof safety test leads (CAT III and IV/1000 V according to EN 61010-031)
- The test plugs are equipped with two gray test sockets per position, for further color versions, see the range of accessories
- Additional test leads, assembled with ring and fork-type cable lugs, can be attached with test sockets
- Other VDE versions available on request

| Notes: | |
|---|--|
| To create panel cutouts, see phoenixcontact.net/products . | |
| 1) Derating curve available on request. | |
| 2) Rated surge voltage of 5 kV. | |

Long contacts
Short contacts

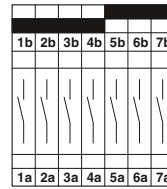

E7



6 (10) mm², 30 A, test terminal strip, for wall mounting, VDE coded type E7

| Max. electrical data | |
|---|--|
| Rated data | |
| Rated voltage | [V] 400 ²⁾ |
| Nominal current / cross section | [A] / [mm ²] 24 ¹⁾ /6 |
| Rated cross section | [mm ²] 6 |
| Cross section range | AWG 24 - 8 |
| Connection capacity | |
| 1 conductor | [mm ²] 0.2 - 10 |
| 2 conductors (of the same type) | [mm ²] 0.2 - 2.5 |
| 2 stranded conductors with a TWIN ferrule | [mm ²] 0.25 - 1.5 |
| General data | |
| Stripping length | [mm] 10 |
| Screw thread | M4 |
| Tightening torque | [Nm] 1.5 - 1.8 |
| Tightening torque for wall fastening | [Nm] 0.8 - 1 |
| Panel thickness | [mm] 1 - 4 |
| Tightening torque: test socket screw | [Nm] - |
| Insulating material | PA |
| Inflammability class according to UL 94 | V0 |

| Technical data | | | |
|----------------------|----------------------|-----------------------------|----------------|
| I _{max} [A] | U _{max} [V] | max. Ø [mm ²] | AWG |
| 30 | 400 ²⁾ | 0.2 - 10 | 24 - 8 |
| IEC 60947-7-1 | | | |
| IEC | UL/CUL | CSA | IEC/EN 60079-7 |
| Connection capacity | | ferrule | |
| solid | stranded | with/without plastic sleeve | |
| 0.2 - 10 | 0.2 - 10 | 0.25 - 6 | 0.25 - 6 |
| 0.2 - 2.5 | 0.2 - 2.5 | 0.25 - 1.5 | - |
| | | | 0.5 - 2.5 |

| Description | Color |
|---|-------|
| Test terminal strip , for wall mounting | gray |
| Test terminal strip , for mounting on NS 35... | gray |
| Test plug , with twist grip | gray |
| With standard handle | gray |
| Test plug , 1-pos., with cover | gray |
| Blind plug , sealable | gray |

| | |
|--|-------------|
| Test socket , insulated | transparent |
| | red |
| | blue |
| | yellow |
| | green |
| | violet |
| | black |
| | gray |
| | brown |
| Cover profile , supply length 1 m | transparent |
| Cover profile holder , can be snapped on and sealed | gray |
| Cover profile , supply length 1 m | transparent |
| End brackets , for AP-ME cover profile, sealable, with storage option for jumpers | gray |
| Holder , for AP-ME cover profile | gray |
| Fork-type cable lug , insulated according to UL | red |
| | blue |
| Ring cable lug , insulated according to UL | red |
| | blue |
| Screwdriver | |

| | |
|--------------------------------|--|
| Lateral groove labeling | |
|--------------------------------|--|

| Ordering data | | |
|--------------------|----------------|-------------|
| Type | Order No. | Pcs. / Pkt. |
| UTWE 6-2/E7 | 3069412 | 1 |

| Accessories | | |
|--|----------------|-------------|
| Type | Order No. | Pcs. / Pkt. |
| AP RSC-T | 3059139 | 10 |
| APH-UTWE 6-2 | 3069057 | 10 |
| SF-SL 0,8X4,0-100 | 1212551 | 10 |
| UC-TM 8, UCT-TM 8, ZB 8 or TMT (EX9,5)R (see Catalog 5) | | |



6 (10) mm², 30 A, test terminal strip, for DIN rail mounting, VDE coded type E7



24 A, test plug, bridge assignment according to circuit diagram, VDE coded type E7



Blind plug, VDE coded type E7

| Technical data | | | |
|----------------------|----------------------|-------------------------------------|----------------|
| I _{max} [A] | U _{max} [V] | max. Ø [mm ²] | AWG |
| 30 | 400 ²) | 0.2 - 10 | 24 - 8 |
| IEC 60947-7-1 | | | |
| IEC | UL/CUL | CSA | IEC/EN 60079-7 |
| 400 ²) | - | - | - |
| 24 ¹)/6 | - | - | - |
| 6 | - | - | - |
| 24 - 8 | - | - | - |
| solid | stranded | ferrule with/without plastic sleeve | |
| 0.2 - 10 | 0.2 - 10 | 0.25 - 6 | 0.25 - 6 |
| 0.2 - 2.5 | 0.2 - 2.5 | 0.25 - 1.5 | - |
| | | | 0.5 - 2.5 |
| 10 | | | |
| M4 | | | |
| 1.5 - 1.8 | | | |
| - | | | |
| - | | | |
| - | | | |
| PA | | | |
| V0 | | | |

| Technical data | | | |
|----------------------|----------------------|-------------------------------------|---------|
| I _{max} [A] | U _{max} [V] | max. Ø [mm ²] | AWG |
| 24 | 400 ²) | 0.5 - 2.5 | 20 - 14 |
| IEC | | | |
| UL/CUL | CSA | IEC/EN 60079-7 | |
| 400 ²) | - | - | - |
| 24/2.5 | - | - | - |
| 6 | - | - | - |
| 20 - 14 | - | - | - |
| solid | stranded | ferrule with/without plastic sleeve | |
| - | 0.5 - 2.5 | - | - |
| - | - | - | - |
| 10 | | | |
| M4 | | | |
| 1.5 - 1.8 | | | |
| - | | | |
| - | | | |
| - | | | |
| 0.5 - 0.6 | | | |
| PA | | | |
| V0 | | | |

| Technical data | | | |
|----------------|----------|-------------------------------------|-----|
| | | max. Ø [mm ²] | AWG |
| | | - | - |
| IEC | | | |
| UL/CUL | CSA | IEC/EN 60079-7 | |
| - | - | - | - |
| - | - | - | - |
| - | - | - | - |
| - | - | - | - |
| solid | stranded | ferrule with/without plastic sleeve | |
| - | - | - | - |
| - | - | - | - |
| 10 | | | |
| M4 | | | |
| 1.5 - 1.8 | | | |
| - | | | |
| - | | | |
| - | | | |
| PA | | | |
| V0 | | | |

| Ordering data | | |
|---------------|-----------|-------------|
| Type | Order No. | Pcs. / Pkt. |
| UTRE 6-2/E7 | 3069425 | 1 |

| Ordering data | | |
|---------------|-----------|-------------|
| Type | Order No. | Pcs. / Pkt. |
| FTPR-2/E7 | 3069486 | 1 |
| FTP-2/E7 | 3069472 | 1 |
| FTP-2/1 | 3069469 | 1 |

| Ordering data | | |
|---------------|-----------|-------------|
| Type | Order No. | Pcs. / Pkt. |
| FBP-2/E7 | 3069499 | 1 |

| Accessories | | | |
|-------------|-------------|---------|----|
| AP-ME | METER | 3034361 | 10 |
| APH-ME | | 3034374 | 10 |
| APT-ME | | 3034358 | 10 |
| SF-SL | 0,8X4,0-100 | 1212551 | 10 |

| Accessories | | | |
|---------------------|--|---------|-----|
| PSBJ-URTK 6 FARBLOS | | 3026450 | 10 |
| PSBJ-URTK 6 RD | | 3026719 | 10 |
| PSBJ-URTK 6 BU | | 3026434 | 10 |
| PSBJ-URTK 6 YE | | 3026405 | 10 |
| PSBJ-URTK 6 GN | | 3026418 | 10 |
| PSBJ-URTK 6 VT | | 3026421 | 10 |
| PSBJ-URTK 6 BK | | 3026447 | 10 |
| PSBJ-URTK 6 GY | | 3026612 | 10 |
| PSBJ-URTK 6 BN | | 3026971 | 10 |
| C-FCI 1,5/M3 | | 3240032 | 100 |
| C-FCI 2,5/M3 | | 3240037 | 100 |
| C-RCI 1,5/M3 | | 3240016 | 100 |
| C-RCI 2,5/M3 | | 3240021 | 100 |

| Accessories | | | |
|-------------|--|--|--|
|-------------|--|--|--|

UC-TM 8, UCT-TM 8, ZB 8 or TMT (EX9,5)R (see Catalog 5)

UC-TM 8, UCT-TM 8, ZB 8 or TMT (EX9,5)R (see Catalog 5)

UC-TM 8, UCT-TM 8, ZB 8 or TMT (EX9,5)R (see Catalog 5)

FAME plug-in test system

Test terminal strip with UT ... screw connection, VDE type A14, for wall and DIN rail mounting

The **VDE A14** version described here is suitable as a plug-in test system for three-stage automatic frequency load shedding (AFLS), as zero-power comparison protection, and as stator and rotor ground fault protection.

- The test plugs are assembled according to the circuit diagram
- A transparent covering hood protects the jumpers. The covering hood can only be removed by dismantling the test plug
- All VDE-specified 7, 14, and 19-pos. versions are supplied with exclusive coding for the matching test plug and blind plug
- The components are supplied pre-marked according to the VDE Directive
- Test signals can be connected with touch-proof safety test leads (CAT III and IV/1000 V according to EN 61010-031)
- The test plugs are equipped with two gray test sockets per position, for further color versions, see the range of accessories
- Additional test leads, assembled with ring and fork-type cable lugs, can be attached with test sockets
- Other VDE versions available on request



6 (10) mm², 30 A, test terminal strip, for wall mounting, VDE coded type A14

| Notes: |
|---|
| To create panel cutouts, see phoenixcontact.net/products. |
| ¹⁾ Derating curve available on request. |
| ²⁾ Rated surge voltage of 5 kV. |

| Max. electrical data | |
|---|--|
| Rated data | |
| Rated voltage | [V] 400 ²⁾ |
| Nominal current / cross section | [A] / [mm ²] 24 ¹⁾ /6 |
| Rated cross section | [mm ²] 6 |
| Cross section range | AWG 24 - 8 |
| Connection capacity | |
| 1 conductor | [mm ²] 0.2 - 10 |
| 2 conductors (of the same type) | [mm ²] 0.2 - 2.5 |
| 2 stranded conductors with a TWIN ferrule | [mm ²] 0.25 - 1.5 |
| General data | |
| Stripping length | [mm] 10 |
| Screw thread | M4 |
| Tightening torque | [Nm] 1.5 - 1.8 |
| Tightening torque for wall fastening | [Nm] 0.8 - 1 |
| Panel thickness | [mm] 1 - 4 |
| Tightening torque: test socket screw | [Nm] - |
| Insulating material | PA |
| Inflammability class according to UL 94 | V0 |

| Technical data | | | |
|----------------------|----------------------|-----------------------------|----------------|
| I _{max} [A] | U _{max} [V] | max. Ø [mm ²] | AWG |
| 30 | 400 ²⁾ | 0.2 - 10 | 24 - 8 |
| IEC 60947-7-1 | UL/CUL | CSA | IEC/EN 60079-7 |
| Connection capacity | | ferrule | |
| solid | stranded | with/without plastic sleeve | |
| 0.2 - 10 | 0.2 - 10 | 0.25 - 6 | 0.25 - 6 |
| 0.2 - 2.5 | 0.2 - 2.5 | 0.25 - 1.5 | - |
| | | | 0.5 - 2.5 |

| Description | Color |
|---|-------|
| Test terminal strip , for wall mounting | gray |
| Test terminal strip , for mounting on NS 35... | gray |
| Test plug , with twist grip | gray |
| With standard handle | gray |
| Test plug , 1-pos., with cover | gray |
| Blind plug , sealable | gray |

| | |
|--|---|
| Test socket , insulated | transparent red blue yellow green violet black gray brown |
| Cover profile , supply length 1 m | transparent |
| Cover profile holder , can be snapped on and sealed | gray |
| Cover profile , supply length 1 m | transparent |
| End brackets , for AP-ME cover profile, sealable, with storage option for jumpers | gray |
| Holder , for AP-ME cover profile | gray |
| Fork-type cable lug , insulated according to UL | red blue |
| Ring cable lug , insulated according to UL | red blue |

| | |
|--------------------------------|---|
| Screwdriver | SF-SL 0,8X4,0-100 |
| Lateral groove labeling | UC-TM 8, UCT-TM 8, ZB 8 or TMT (EX9,5)R (see Catalog 5) |

| Ordering data | | |
|---------------------|----------------|-------------|
| Type | Order No. | Pcs. / Pkt. |
| UTWE 6-2/A14 | 3069413 | 1 |

| Accessories | | |
|--|---------|----|
| AP RSC-T | 3059139 | 10 |
| APH-UTWE 6-2 | 3069057 | 10 |
| SF-SL 0,8X4,0-100 | 1212551 | 10 |
| UC-TM 8, UCT-TM 8, ZB 8 or TMT (EX9,5)R (see Catalog 5) | | |



6 (10) mm², 30 A, test terminal strip, for DIN rail mounting, VDE coded type A14



24 A, test plug, bridge assignment according to circuit diagram, VDE coded type A14



Blind plug, VDE coded type A14

| Technical data | | | |
|-----------------------------|----------------------|---------------------------|----------|
| I _{max} [A] | U _{max} [V] | max. Ø [mm ²] | AWG |
| 30 | 400 ²) | 0.2 - 10 | 24 - 8 |
| IEC 60947-7-1 | | | |
| IEC | | | |
| UL/CUL | CSA | IEC/EN 60079-7 | |
| 400 ²) | - | - | - |
| 24 ¹)/6 | - | - | - |
| 6 | - | - | - |
| 24 - 8 | - | - | - |
| solid | stranded | ferrule | |
| with/without plastic sleeve | | | |
| 0.2 - 10 | 0.2 - 10 | 0.25 - 6 | 0.25 - 6 |
| 0.2 - 2.5 | 0.2 - 2.5 | 0.25 - 1.5 | - |
| 0.5 - 2.5 | | | |
| 10 | - | - | - |
| M4 | - | - | - |
| 1.5 - 1.8 | - | - | - |
| - | - | - | - |
| - | - | - | - |
| - | - | - | - |
| PA | - | - | - |
| V0 | - | - | - |

| Technical data | | | |
|-----------------------------|----------------------|---------------------------|---------|
| I _{max} [A] | U _{max} [V] | max. Ø [mm ²] | AWG |
| 24 | 400 ²) | 0.5 - 2.5 | 20 - 14 |
| IEC | | | |
| UL/CUL | CSA | IEC/EN 60079-7 | |
| 400 ²) | - | - | - |
| 24/2.5 | - | - | - |
| 6 | - | - | - |
| 20 - 14 | - | - | - |
| solid | stranded | ferrule | |
| with/without plastic sleeve | | | |
| - | 0.5 - 2.5 | - | - |
| - | - | - | - |
| 0.5 - 0.6 | - | - | - |
| PA | - | - | - |
| V0 | - | - | - |

| Technical data | | | |
|-----------------------------|----------|---------------------------|-----|
| | | max. Ø [mm ²] | AWG |
| | | - | - |
| IEC | | | |
| UL/CUL | CSA | IEC/EN 60079-7 | |
| - | - | - | - |
| - | - | - | - |
| - | - | - | - |
| - | - | - | - |
| solid | stranded | ferrule | |
| with/without plastic sleeve | | | |
| - | - | - | - |
| - | - | - | - |
| PA | - | - | - |
| V0 | - | - | - |

| Ordering data | | |
|---------------|-----------|-------------|
| Type | Order No. | Pcs. / Pkt. |
| UTRE 6-2/A14 | 3069426 | 1 |

| Ordering data | | |
|---------------|-----------|-------------|
| Type | Order No. | Pcs. / Pkt. |
| FTPR-2/A14 | 3069487 | 1 |
| FTP-2/A14 | 3069474 | 1 |
| FTP-2/1 | 3069469 | 1 |

| Ordering data | | |
|---------------|-----------|-------------|
| Type | Order No. | Pcs. / Pkt. |
| FBP-2/A14 | 3069500 | 1 |

| Accessories | | | |
|-------------|-------------|---------|----|
| AP-ME | METER | 3034361 | 10 |
| APH-ME | | 3034374 | 10 |
| APT-ME | | 3034358 | 10 |
| SF-SL | 0,8X4,0-100 | 1212551 | 10 |

| Accessories | | | |
|---------------------|--|---------|-----|
| PSBJ-URTK 6 FARBLOS | | 3026450 | 10 |
| PSBJ-URTK 6 RD | | 3026719 | 10 |
| PSBJ-URTK 6 BU | | 3026434 | 10 |
| PSBJ-URTK 6 YE | | 3026405 | 10 |
| PSBJ-URTK 6 GN | | 3026418 | 10 |
| PSBJ-URTK 6 VT | | 3026421 | 10 |
| PSBJ-URTK 6 BK | | 3026447 | 10 |
| PSBJ-URTK 6 GY | | 3026612 | 10 |
| PSBJ-URTK 6 BN | | 3026971 | 10 |
| C-FCI 1,5/M3 | | 3240032 | 100 |
| C-FCI 2,5/M3 | | 3240037 | 100 |
| C-RCI 1,5/M3 | | 3240016 | 100 |
| C-RCI 2,5/M3 | | 3240021 | 100 |

| Accessories | | | |
|-------------|--|--|--|
|-------------|--|--|--|

UC-TM 8, UCT-TM 8, ZB 8 or TMT (EX9,5)R (see Catalog 5)

UC-TM 8, UCT-TM 8, ZB 8 or TMT (EX9,5)R (see Catalog 5)

UC-TM 8, UCT-TM 8, ZB 8 or TMT (EX9,5)R (see Catalog 5)

FAME plug-in test system

Test terminal strip with UT ... screw connection, VDE type B14, for wall and DIN rail mounting

The **VDE B14** version described here is suitable as a plug-in test system in overcurrent directional protection, distance protection for high and medium voltage, as well as voltage regulation.

- The test plugs are assembled with jumpers and contact tab lengths according to the circuit diagram
- A transparent covering hood protects the jumpers. The covering hood can only be removed by dismantling the test plug
- All VDE-specified 7, 14, and 19-pos. versions are supplied with exclusive coding for the matching test plug and blind plug
- The components are supplied pre-marked according to the VDE Directive
- Test signals can be connected with touch-proof safety test leads (CAT III and IV/1000 V according to EN 61010-031)
- The test plugs are equipped with two gray test sockets per position, for further color versions, see the range of accessories
- Additional test leads, assembled with ring and fork-type cable lugs, can be attached with test sockets
- Other VDE versions available on request

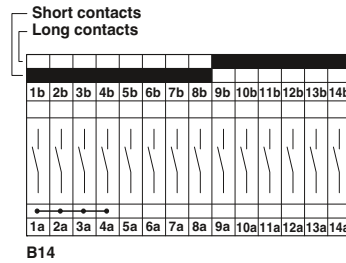

6 (10) mm², 30 A, test terminal strip, for wall mounting, VDE coded type B14

| Notes: |
|---|
| To create panel cutouts, see phoenixcontact.net/products . |
| ¹⁾ Derating curve available on request. |
| ²⁾ Rated surge voltage of 5 kV. |

| Max. electrical data | |
|---|--|
| Rated data | |
| Rated voltage | [V] 400 ²⁾ |
| Nominal current / cross section | [A] / [mm ²] 24 ¹⁾ /6 |
| Rated cross section | [mm ²] 6 |
| Cross section range | AWG 24 - 8 |
| Connection capacity | |
| 1 conductor | [mm ²] 0.2 - 10 |
| 2 conductors (of the same type) | [mm ²] 0.2 - 2.5 |
| 2 stranded conductors with a TWIN ferrule | [mm ²] 0.25 - 1.5 |
| General data | |
| Stripping length | [mm] 10 |
| Screw thread | M4 |
| Tightening torque | [Nm] 1.5 - 1.8 |
| Tightening torque for wall fastening | [Nm] 0.8 - 1 |
| Panel thickness | [mm] 1 - 4 |
| Tightening torque: test socket screw | [Nm] - |
| Insulating material | PA |
| Inflammability class according to UL 94 | V0 |

| Technical data | | | |
|----------------------|----------------------|-----------------------------|----------------|
| I _{max} [A] | U _{max} [V] | max. Ø [mm ²] | AWG |
| 30 | 400 ²⁾ | 0.2 - 10 | 24 - 8 |
| IEC 60947-7-1 | | | |
| IEC | UL/CUL | CSA | IEC/EN 60079-7 |
| Connection capacity | | ferrule | |
| solid | stranded | with/without plastic sleeve | |
| 0.2 - 10 | 0.2 - 10 | 0.25 - 6 | 0.25 - 6 |
| 0.2 - 2.5 | 0.2 - 2.5 | 0.25 - 1.5 | - |
| | | | 0.5 - 2.5 |

| Description | Color |
|---|-------|
| Test terminal strip , for wall mounting | gray |
| Test terminal strip , for mounting on NS 35... | gray |
| Test plug , with twist grip | gray |
| With standard handle | gray |
| Test plug , 1-pos., with cover | gray |
| Blind plug , sealable | gray |

| Ordering data | | |
|---------------------|----------------|-------------|
| Type | Order No. | Pcs. / Pkt. |
| UTWE 6-2/B14 | 3069414 | 1 |

| | |
|--|---|
| Test socket , insulated | transparent red blue yellow green violet black gray brown |
| Cover profile , supply length 1 m | transparent |
| Cover profile holder , can be snapped on and sealed | gray |
| Cover profile , supply length 1 m | transparent |
| End brackets , for AP-ME cover profile, sealable, with storage option for jumpers | gray |
| Holder , for AP-ME cover profile | gray |
| Fork-type cable lug , insulated according to UL | red blue |
| Ring cable lug , insulated according to UL | red blue |

| Accessories | | |
|--------------------------|----------------|-------------|
| Type | Order No. | Pcs. / Pkt. |
| AP RSC-T | 3059139 | 10 |
| APH-UTWE 6-2 | 3069057 | 10 |
| SF-SL 0,8X4,0-100 | 1212551 | 10 |

| Screwdriver |
|--------------------------------|
| Lateral groove labeling |

| |
|--|
| UC-TM 8, UCT-TM 8, ZB 8 or TMT (EX9,5)R (see Catalog 5) |
|--|



6 (10) mm², 30 A, test terminal strip, for DIN rail mounting, VDE coded type B14



24 A, test plug, bridge assignment according to circuit diagram, VDE coded type B14



Blind plug, VDE coded type B14

| Technical data | | | |
|----------------------|----------------------|-------------------------------------|----------------|
| I _{max} [A] | U _{max} [V] | max. Ø [mm ²] | AWG |
| 30 | 400 ²) | 0.2 - 10 | 24 - 8 |
| IEC 60947-7-1 | | | |
| IEC | UL/CUL | CSA | IEC/EN 60079-7 |
| 400 ²) | - | - | - |
| 24 ¹)/6 | - | - | - |
| 6 | - | - | - |
| 24 - 8 | - | - | - |
| solid | stranded | ferrule with/without plastic sleeve | |
| 0.2 - 10 | 0.2 - 10 | 0.25 - 6 | 0.25 - 6 |
| 0.2 - 2.5 | 0.2 - 2.5 | 0.25 - 1.5 | - |
| | | | 0.5 - 2.5 |
| 10 | | | |
| M4 | | | |
| 1.5 - 1.8 | | | |
| - | | | |
| - | | | |
| - | | | |
| 0.5 - 0.6 | | | |
| PA | | | |
| V0 | | | |

| Technical data | | | |
|----------------------|----------------------|-------------------------------------|---------|
| I _{max} [A] | U _{max} [V] | max. Ø [mm ²] | AWG |
| 24 | 400 ²) | 0.5 - 2.5 | 20 - 14 |
| IEC | | | |
| UL/CUL | CSA | IEC/EN 60079-7 | |
| 400 ²) | - | - | - |
| 24/2.5 | - | - | - |
| 6 | - | - | - |
| 20 - 14 | - | - | - |
| solid | stranded | ferrule with/without plastic sleeve | |
| - | 0.5 - 2.5 | - | - |
| - | - | - | - |
| | | | |
| | | | |
| | | | |
| | | | |
| 0.5 - 0.6 | | | |
| PA | | | |
| V0 | | | |

| Technical data | | | |
|----------------|----------|-------------------------------------|-----|
| | | max. Ø [mm ²] | AWG |
| | | - | - |
| IEC | | | |
| UL/CUL | CSA | IEC/EN 60079-7 | |
| - | - | - | - |
| - | - | - | - |
| - | - | - | - |
| - | - | - | - |
| solid | stranded | ferrule with/without plastic sleeve | |
| - | - | - | - |
| - | - | - | - |
| | | | |
| | | | |
| | | | |
| | | | |
| | | | |
| | | | |
| PA | | | |
| V0 | | | |

| Ordering data | | |
|---------------|-----------|-------------|
| Type | Order No. | Pcs. / Pkt. |
| UTRE 6-2/B14 | 3069427 | 1 |

| Ordering data | | |
|---------------|-----------|-------------|
| Type | Order No. | Pcs. / Pkt. |
| FTPR-2/B14 | 3069488 | 1 |
| FTP-2/B14 | 3069475 | 1 |
| FTP-2/1 | 3069469 | 1 |

| Ordering data | | |
|---------------|-----------|-------------|
| Type | Order No. | Pcs. / Pkt. |
| FBP-2/B14 | 3069501 | 1 |

| Accessories | | | |
|-------------|-------------|---------|----|
| AP-ME | METER | 3034361 | 10 |
| APH-ME | | 3034374 | 10 |
| APT-ME | | 3034358 | 10 |
| SF-SL | 0,8X4,0-100 | 1212551 | 10 |

| Accessories | | | |
|---------------------|--|---------|-----|
| PSBJ-URTK 6 FARBLOS | | 3026450 | 10 |
| PSBJ-URTK 6 RD | | 3026719 | 10 |
| PSBJ-URTK 6 BU | | 3026434 | 10 |
| PSBJ-URTK 6 YE | | 3026405 | 10 |
| PSBJ-URTK 6 GN | | 3026418 | 10 |
| PSBJ-URTK 6 VT | | 3026421 | 10 |
| PSBJ-URTK 6 BK | | 3026447 | 10 |
| PSBJ-URTK 6 GY | | 3026612 | 10 |
| PSBJ-URTK 6 BN | | 3026971 | 10 |
| C-FCI 1,5/M3 | | 3240032 | 100 |
| C-FCI 2,5/M3 | | 3240037 | 100 |
| C-RCI 1,5/M3 | | 3240016 | 100 |
| C-RCI 2,5/M3 | | 3240021 | 100 |

| Accessories | | | |
|-------------|--|--|--|
|-------------|--|--|--|

UC-TM 8, UCT-TM 8, ZB 8 or TMT (EX9,5)R (see Catalog 5)

UC-TM 8, UCT-TM 8, ZB 8 or TMT (EX9,5)R (see Catalog 5)

UC-TM 8, UCT-TM 8, ZB 8 or TMT (EX9,5)R (see Catalog 5)

FAME plug-in test system

Test terminal strip with UT ... screw connection, VDE type C14, for wall and DIN rail mounting

The **VDE C14** version described here is suitable as a plug-in test system in overcurrent time protection, unbalanced load protection, and stator ground fault protection for busbar operation.

- The test plugs are assembled with jumpers and contact tab lengths according to the circuit diagram
- A transparent covering hood protects the jumpers. The covering hood can only be removed by dismantling the test plug
- All VDE-specified 7, 14, and 19-pos. versions are supplied with exclusive coding for the matching test plug and blind plug
- The components are supplied pre-marked according to the VDE Directive
- Test signals can be connected with touch-proof safety test leads (CAT III and IV/1000 V according to EN 61010-031)
- The test plugs are equipped with two gray test sockets per position, for further color versions, see the range of accessories
- Additional test leads, assembled with ring and fork-type cable lugs, can be attached with test sockets
- Other VDE versions available on request

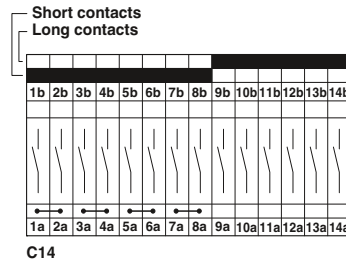

6 (10) mm², 30 A, test terminal strip, for wall mounting, VDE coded type C14

| Notes: |
|---|
| To create panel cutouts, see phoenixcontact.net/products . |
| ¹⁾ Derating curve available on request. |
| ²⁾ Rated surge voltage of 5 kV. |

| Max. electrical data | |
|---|--|
| Rated data | |
| Rated voltage | [V] 400 ²⁾ |
| Nominal current / cross section | [A] / [mm ²] 24 ¹⁾ /6 |
| Rated cross section | [mm ²] 6 |
| Cross section range | AWG 24 - 8 |
| Connection capacity | |
| 1 conductor | [mm ²] 0.2 - 10 |
| 2 conductors (of the same type) | [mm ²] 0.2 - 2.5 |
| 2 stranded conductors with a TWIN ferrule | [mm ²] 0.25 - 1.5 |
| General data | |
| Stripping length | [mm] 10 |
| Screw thread | M4 |
| Tightening torque | [Nm] 1.5 - 1.8 |
| Tightening torque for wall fastening | [Nm] 0.8 - 1 |
| Panel thickness | [mm] 1 - 4 |
| Tightening torque: test socket screw | [Nm] - |
| Insulating material | PA |
| Inflammability class according to UL 94 | V0 |

| Technical data | | | |
|----------------------------|-------------------|-----------------------------|----------------|
| I_{max} [A] | U_{max} [V] | max. Ø [mm ²] | AWG |
| 30 | 400 ²⁾ | 0.2 - 10 | 24 - 8 |
| IEC 60947-7-1 | UL/CUL | CSA | IEC/EN 60079-7 |
| Connection capacity | | ferrule | |
| solid | stranded | with/without plastic sleeve | |
| 0.2 - 10 | 0.2 - 10 | 0.25 - 6 | 0.25 - 6 |
| 0.2 - 2.5 | 0.2 - 2.5 | 0.25 - 1.5 | - |
| | | | 0.5 - 2.5 |

| Description | Color |
|---|-------|
| Test terminal strip , for wall mounting | gray |
| Test terminal strip , for mounting on NS 35... | gray |
| Test plug , with twist grip | gray |
| With standard handle | gray |
| Test plug , 1-pos., with cover | gray |
| Blind plug , sealable | gray |

| | |
|--|---|
| Test socket , insulated | transparent red blue yellow green violet black gray brown |
| Cover profile , supply length 1 m | transparent |
| Cover profile holder , can be snapped on and sealed | gray |
| Cover profile , supply length 1 m | transparent |
| End brackets , for AP-ME cover profile, sealable, with storage option for jumpers | gray |
| Holder , for AP-ME cover profile | gray |
| Fork-type cable lug , insulated according to UL | red blue |
| Ring cable lug , insulated according to UL | red blue |
| Screwdriver | |

| |
|--------------------------------|
| Lateral groove labeling |
|--------------------------------|

| Ordering data | | |
|---------------------|------------------|--------------------|
| Type | Order No. | Pcs. / Pkt. |
| UTWE 6-2/C14 | 3069415 | 1 |

| Accessories | | |
|--|----------------|-----------|
| AP RSC-T | 3059139 | 10 |
| APH-UTWE 6-2 | 3069057 | 10 |
| SF-SL 0,8X4,0-100 | 1212551 | 10 |
| UC-TM 8, UCT-TM 8, ZB 8 or TMT (EX9,5)R (see Catalog 5) | | |



6 (10) mm², 30 A, test terminal strip, for DIN rail mounting, VDE coded type C14



24 A, test plug, bridge assignment according to circuit diagram, VDE coded type C14



Blind plug, VDE coded type C14

| Technical data | | | |
|-----------------------------|----------------------|---------------------------|----------|
| I _{max} [A] | U _{max} [V] | max. Ø [mm ²] | AWG |
| 30 | 400 ²) | 0.2 - 10 | 24 - 8 |
| IEC 60947-7-1 | | | |
| IEC | | | |
| UL/CUL | CSA | IEC/EN 60079-7 | |
| 400 ²) | - | - | - |
| 24 ¹)/6 | - | - | - |
| 6 | - | - | - |
| 24 - 8 | - | - | - |
| solid | stranded | ferrule | |
| with/without plastic sleeve | | | |
| 0.2 - 10 | 0.2 - 10 | 0.25 - 6 | 0.25 - 6 |
| 0.2 - 2.5 | 0.2 - 2.5 | 0.25 - 1.5 | - |
| 0.5 - 2.5 | | | |
| 10 | - | - | - |
| M4 | - | - | - |
| 1.5 - 1.8 | - | - | - |
| - | - | - | - |
| - | - | - | - |
| - | - | - | - |
| PA | - | - | - |
| V0 | - | - | - |

| Technical data | | | |
|-----------------------------|----------------------|---------------------------|---------|
| I _{max} [A] | U _{max} [V] | max. Ø [mm ²] | AWG |
| 24 | 400 ²) | 0.5 - 2.5 | 20 - 14 |
| IEC | | | |
| UL/CUL | CSA | IEC/EN 60079-7 | |
| 400 ²) | - | - | - |
| 24/2.5 | - | - | - |
| 6 | - | - | - |
| 20 - 14 | - | - | - |
| solid | stranded | ferrule | |
| with/without plastic sleeve | | | |
| - | 0.5 - 2.5 | - | - |
| - | - | - | - |
| 0.5 - 0.6 | - | - | - |
| PA | - | - | - |
| V0 | - | - | - |

| Technical data | | | |
|-----------------------------|----------|---------------------------|-----|
| | | max. Ø [mm ²] | AWG |
| | | - | - |
| IEC | | | |
| UL/CUL | CSA | IEC/EN 60079-7 | |
| - | - | - | - |
| - | - | - | - |
| - | - | - | - |
| - | - | - | - |
| solid | stranded | ferrule | |
| with/without plastic sleeve | | | |
| - | - | - | - |
| - | - | - | - |
| PA | - | - | - |
| V0 | - | - | - |

| Ordering data | | |
|---------------|-----------|-------------|
| Type | Order No. | Pcs. / Pkt. |
| UTRE 6-2/C14 | 3069428 | 1 |

| Ordering data | | |
|---------------|-----------|-------------|
| Type | Order No. | Pcs. / Pkt. |
| FTPR-2/C14 | 3069489 | 1 |
| FTP-2/C14 | 3069476 | 1 |
| FTP-2/1 | 3069469 | 1 |

| Ordering data | | |
|---------------|-----------|-------------|
| Type | Order No. | Pcs. / Pkt. |
| FBP-2/C14 | 3069502 | 1 |

| Accessories | | | |
|-------------|-------------|---------|----|
| AP-ME | METER | 3034361 | 10 |
| APH-ME | | 3034374 | 10 |
| APT-ME | | 3034358 | 10 |
| SF-SL | 0,8X4,0-100 | 1212551 | 10 |

| Accessories | | | |
|---------------------|--|---------|-----|
| PSBJ-URTK 6 FARBLOS | | 3026450 | 10 |
| PSBJ-URTK 6 RD | | 3026719 | 10 |
| PSBJ-URTK 6 BU | | 3026434 | 10 |
| PSBJ-URTK 6 YE | | 3026405 | 10 |
| PSBJ-URTK 6 GN | | 3026418 | 10 |
| PSBJ-URTK 6 VT | | 3026421 | 10 |
| PSBJ-URTK 6 BK | | 3026447 | 10 |
| PSBJ-URTK 6 GY | | 3026612 | 10 |
| PSBJ-URTK 6 BN | | 3026971 | 10 |
| C-FCI 1,5/M3 | | 3240032 | 100 |
| C-FCI 2,5/M3 | | 3240037 | 100 |
| C-RCI 1,5/M3 | | 3240016 | 100 |
| C-RCI 2,5/M3 | | 3240021 | 100 |

| Accessories | | | |
|-------------|--|--|--|
|-------------|--|--|--|

UC-TM 8, UCT-TM 8, ZB 8 or TMT (EX9,5)R (see Catalog 5)

UC-TM 8, UCT-TM 8, ZB 8 or TMT (EX9,5)R (see Catalog 5)

UC-TM 8, UCT-TM 8, ZB 8 or TMT (EX9,5)R (see Catalog 5)

Modular terminal blocks

FAME plug-in test system

Test terminal strip with UT ... screw connection, VDE type B19, for wall and DIN rail mounting

The **VDE B19** version described here is suitable as a plug-in test system in distance protection for high voltage.

- The test plugs are assembled with jumpers and contact tab lengths according to the circuit diagram
- A transparent covering hood protects the jumpers. The covering hood can only be removed by dismantling the test plug
- All VDE-specified 7, 14, and 19-pos. versions are supplied with exclusive coding for the matching test plug and blind plug
- The components are supplied pre-marked according to the VDE Directive
- Test signals can be connected with touch-proof safety test leads (CAT III and IV/1000 V according to EN 61010-031)
- The test plugs are equipped with two gray test sockets per position, for further color versions, see the range of accessories
- Additional test leads, assembled with ring and fork-type cable lugs, can be attached with test sockets
- Other VDE versions available on request



6 (10) mm², 30 A, test terminal strip, for wall mounting, VDE coded type B19

| Notes: | |
|---|--|
| To create panel cutouts, see phoenixcontact.net/products . | |
| 1) Derating curve available on request. | |
| 2) Rated surge voltage of 5 kV. | |

| Max. electrical data | |
|---|--|
| Rated data | |
| Rated voltage | [V] 400 ²⁾ |
| Nominal current / cross section | [A] / [mm ²] 24 ¹⁾ /6 |
| Rated cross section | [mm ²] 6 |
| Cross section range | AWG 24 - 8 |
| Connection capacity | |
| 1 conductor | [mm ²] 0.2 - 10 |
| 2 conductors (of the same type) | [mm ²] 0.2 - 2.5 |
| 2 stranded conductors with a TWIN ferrule | [mm ²] 0.25 - 6 |
| General data | |
| Stripping length | [mm] 10 |
| Screw thread | M4 |
| Tightening torque | [Nm] 1.5 - 1.8 |
| Tightening torque for wall fastening | [Nm] 0.8 - 1 |
| Panel thickness | [mm] 1 - 4 |
| Tightening torque: test socket screw | [Nm] - |
| Insulating material | PA |
| Inflammability class according to UL 94 | V0 |

| Technical data | | | |
|----------------------|----------------------|-----------------------------|----------------|
| I _{max} [A] | U _{max} [V] | max. Ø [mm ²] | AWG |
| 30 | 400 ²⁾ | 0.2 - 10 | 24 - 8 |
| IEC 60947-7-1 | UL/CUL | CSA | IEC/EN 60079-7 |
| Connection capacity | | ferrule | |
| solid | stranded | with/without plastic sleeve | |
| 0.2 - 10 | 0.2 - 10 | 0.25 - 6 | 0.25 - 6 |
| 0.2 - 2.5 | 0.2 - 2.5 | 0.25 - 1.5 | - |
| | | | 0.5 - 2.5 |

| Description | Color |
|---|-------|
| Test terminal strip , for wall mounting | gray |
| Test terminal strip , for mounting on NS 35... | gray |
| Test plug , with twist grip | gray |
| With standard handle | gray |
| Test plug , 1-pos., with cover | gray |
| Blind plug , sealable | gray |

| Ordering data | | |
|---------------------|----------------|-------------|
| Type | Order No. | Pcs. / Pkt. |
| UTWE 6-2/B19 | 3069416 | 1 |

| | |
|--|---|
| Test socket , insulated | transparent red blue yellow green violet black gray brown |
| Cover profile , supply length 1 m | transparent |
| Cover profile holder , can be snapped on and sealed | gray |
| Cover profile , supply length 1 m | transparent |
| End brackets , for AP-ME cover profile, sealable, with storage option for jumpers | gray |
| Holder , for AP-ME cover profile | gray |
| Fork-type cable lug , insulated according to UL | red blue |
| Ring cable lug , insulated according to UL | red blue |

| Accessories | | |
|--------------------------|----------------|----|
| AP RSC-T | 3059139 | 10 |
| APH-UTWE 6-2 | 3069057 | 10 |
| SF-SL 0,8X4,0-100 | 1212551 | 10 |

| Screwdriver |
|--------------------------------|
| Lateral groove labeling |

| |
|--|
| UC-TM 8, UCT-TM 8, ZB 8 or TMT (EX9,5)R (see Catalog 5) |
|--|



6 (10) mm², 30 A, test terminal strip, for DIN rail mounting, VDE coded type B19



24 A, test plug, bridge assignment according to circuit diagram, VDE coded type B19



Blind plug, VDE coded type B19

| Technical data | | | |
|----------------------|----------------------|-------------------------------------|----------------|
| I _{max} [A] | U _{max} [V] | max. Ø [mm ²] | AWG |
| 30 | 400 ²) | 0.2 - 10 | 24 - 8 |
| IEC 60947-7-1 | | | |
| IEC | UL/CUL | CSA | IEC/EN 60079-7 |
| 400 ²) | - | - | - |
| 24 ¹)/6 | - | - | - |
| 6 | - | - | - |
| 24 - 8 | - | - | - |
| solid | stranded | ferrule with/without plastic sleeve | |
| 0.2 - 10 | 0.2 - 10 | 0.25 - 6 | 0.25 - 6 |
| 0.2 - 2.5 | 0.2 - 2.5 | 0.25 - 1.5 | - |
| | | | 0.5 - 2.5 |
| 10 | | | |
| M4 | | | |
| 1.5 - 1.8 | | | |
| - | | | |
| - | | | |
| - | | | |
| 0.5 - 0.6 | | | |
| PA | | | |
| V0 | | | |

| Technical data | | | |
|----------------------|----------------------|-------------------------------------|---------|
| I _{max} [A] | U _{max} [V] | max. Ø [mm ²] | AWG |
| 24 | 400 ²) | 0.5 - 2.5 | 20 - 14 |
| IEC | | | |
| UL/CUL | CSA | IEC/EN 60079-7 | |
| 400 ²) | - | - | - |
| 24/2.5 | - | - | - |
| 6 | - | - | - |
| 20 - 14 | - | - | - |
| solid | stranded | ferrule with/without plastic sleeve | |
| - | 0.5 - 2.5 | - | - |
| - | - | - | - |
| - | | | |
| - | | | |
| 0.5 - 0.6 | | | |
| PA | | | |
| V0 | | | |

| Technical data | | | |
|----------------|----------|-------------------------------------|-----|
| | | max. Ø [mm ²] | AWG |
| | | - | - |
| IEC | | | |
| UL/CUL | CSA | IEC/EN 60079-7 | |
| - | - | - | - |
| - | - | - | - |
| - | - | - | - |
| - | - | - | - |
| solid | stranded | ferrule with/without plastic sleeve | |
| - | - | - | - |
| - | - | - | - |
| - | | | |
| - | | | |
| PA | | | |
| V0 | | | |

| Ordering data | | |
|---------------|-----------|-------------|
| Type | Order No. | Pcs. / Pkt. |
| UTRE 6-2/B19 | 3069429 | 1 |

| Ordering data | | |
|---------------|-----------|-------------|
| Type | Order No. | Pcs. / Pkt. |
| FTPR-2/B19 | 3069490 | 1 |
| FTP-2/B19 | 3069477 | 1 |
| FTP-2/1 | 3069469 | 1 |

| Ordering data | | |
|---------------|-----------|-------------|
| Type | Order No. | Pcs. / Pkt. |
| FBP-2/B19 | 3069503 | 1 |

| Accessories | | | |
|-------------|-------------|---------|----|
| AP-ME | METER | 3034361 | 10 |
| APH-ME | | 3034374 | 10 |
| APT-ME | | 3034358 | 10 |
| SF-SL | 0,8X4,0-100 | 1212551 | 10 |

| Accessories | | | |
|---------------------|--|---------|-----|
| PSBJ-URTK 6 FARBLOS | | 3026450 | 10 |
| PSBJ-URTK 6 RD | | 3026719 | 10 |
| PSBJ-URTK 6 BU | | 3026434 | 10 |
| PSBJ-URTK 6 YE | | 3026405 | 10 |
| PSBJ-URTK 6 GN | | 3026418 | 10 |
| PSBJ-URTK 6 VT | | 3026421 | 10 |
| PSBJ-URTK 6 BK | | 3026447 | 10 |
| PSBJ-URTK 6 GY | | 3026612 | 10 |
| PSBJ-URTK 6 BN | | 3026971 | 10 |
| C-FCI 1,5/M3 | | 3240032 | 100 |
| C-FCI 2,5/M3 | | 3240037 | 100 |
| C-RCI 1,5/M3 | | 3240016 | 100 |
| C-RCI 2,5/M3 | | 3240021 | 100 |

| Accessories | | | |
|-------------|--|--|--|
|-------------|--|--|--|

UC-TM 8, UCT-TM 8, ZB 8 or TMT (EX9,5)R (see Catalog 5)

UC-TM 8, UCT-TM 8, ZB 8 or TMT (EX9,5)R (see Catalog 5)

UC-TM 8, UCT-TM 8, ZB 8 or TMT (EX9,5)R (see Catalog 5)

FAME plug-in test system

Test terminal strip with UT ... screw connection, VDE type C19, for wall and DIN rail mounting

The **VDE C19** version described here is suitable as a plug-in test system in distance protection as system busbar protection, overcurrent directional protection, and current comparison protection for cables.

- The test plugs are assembled with jumpers and contact tab lengths according to the circuit diagram
- A transparent covering hood protects the jumpers. The covering hood can only be removed by dismantling the test plug
- All VDE-specified 7, 14, and 19-pos. versions are supplied with exclusive coding for the matching test plug and blind plug
- The components are supplied pre-marked according to the VDE Directive
- Test signals can be connected with touch-proof safety test leads (CAT III and IV/1000 V according to EN 61010-031)
- The test plugs are equipped with two gray test sockets per position, for further color versions, see the range of accessories
- Additional test leads, assembled with ring and fork-type cable lugs, can be attached with test sockets
- Other VDE versions available on request

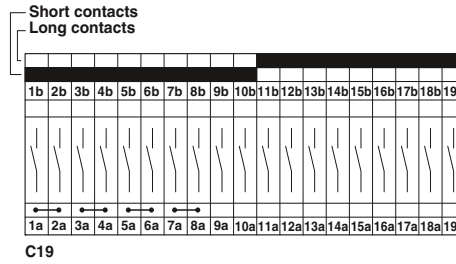

6 (10) mm², 30 A, test terminal strip, for wall mounting, VDE coded type C19

| Notes: | |
|---|--|
| To create panel cutouts, see phoenixcontact.net/products. | |
| 1) Derating curve available on request. | |
| 2) Rated surge voltage of 5 kV. | |

| Max. electrical data | |
|---|--|
| Rated data | |
| Rated voltage | [V] 400 ²⁾ |
| Nominal current / cross section | [A] / [mm ²] 24 ¹⁾ /6 |
| Rated cross section | [mm ²] 6 |
| Cross section range | AWG 24 - 8 |
| Connection capacity | |
| 1 conductor | [mm ²] 0.2 - 10 |
| 2 conductors (of the same type) | [mm ²] 0.2 - 2.5 |
| 2 stranded conductors with a TWIN ferrule | [mm ²] 0.25 - 6 |
| General data | |
| Stripping length | [mm] 10 |
| Screw thread | M4 |
| Tightening torque | [Nm] 1.5 - 1.8 |
| Tightening torque for wall fastening | [Nm] 0.8 - 1 |
| Panel thickness | [mm] 1 - 4 |
| Tightening torque: test socket screw | [Nm] - |
| Insulating material | PA |
| Inflammability class according to UL 94 | V0 |

| Technical data | | | |
|-----------------------------|----------------------|---------------------------|----------------|
| I _{max} [A] | U _{max} [V] | max. Ø [mm ²] | AWG |
| 30 | 400 ²⁾ | 0.2 - 10 | 24 - 8 |
| IEC 60947-7-1 | | | |
| IEC | UL/CUL | CSA | IEC/EN 60079-7 |
| Connection capacity | | | |
| solid | stranded | ferrule | |
| with/without plastic sleeve | | | |
| 0.2 - 10 | 0.2 - 10 | 0.25 - 6 | 0.25 - 6 |
| 0.2 - 2.5 | 0.2 - 2.5 | 0.25 - 1.5 | - |
| | | 0.5 - 2.5 | |

| Description | Color |
|---|-------|
| Test terminal strip , for wall mounting | gray |
| Test terminal strip , for mounting on NS 35... | gray |
| Test plug , with twist grip | gray |
| With standard handle | gray |
| Test plug , 1-pos., with cover | gray |
| Blind plug , sealable | gray |

| | |
|--|-------------|
| Test socket , insulated | transparent |
| | red |
| | blue |
| | yellow |
| | green |
| | violet |
| | black |
| | gray |
| | brown |
| Cover profile , supply length 1 m | transparent |
| Cover profile holder , can be snapped on and sealed | gray |
| Cover profile , supply length 1 m | transparent |
| End brackets , for AP-ME cover profile, sealable, with storage option for jumpers | gray |
| Holder , for AP-ME cover profile | gray |
| Fork-type cable lug , insulated according to UL | red |
| | blue |
| Ring cable lug , insulated according to UL | red |
| | blue |
| Screwdriver | |

| |
|--------------------------------|
| Lateral groove labeling |
|--------------------------------|

| Ordering data | | |
|---------------|------------------|--------------------|
| Type | Order No. | Pcs. / Pkt. |
| UTWE 6-2/C19 | 3069417 | 1 |

| Accessories | | |
|--|---------|----|
| AP RSC-T | 3059139 | 10 |
| APH-UTWE 6-2 | 3069057 | 10 |
| SF-SL 0,8X4,0-100 | 1212551 | 10 |
| UC-TM 8, UCT-TM 8, ZB 8 or TMT (EX9,5)R (see Catalog 5) | | |



6 (10) mm², 30 A, test terminal strip, for DIN rail mounting, VDE coded type C19



24 A, test plug, bridge assignment according to circuit diagram, VDE coded type C19



Blind plug, VDE coded type C19

| Technical data | | | |
|-----------------------------|----------------------|---------------------------|----------|
| I _{max} [A] | U _{max} [V] | max. Ø [mm ²] | AWG |
| 30 | 400 ²) | 0.2 - 10 | 24 - 8 |
| IEC 60947-7-1 | | | |
| IEC | | | |
| UL/CUL | CSA | IEC/EN 60079-7 | |
| 400 ²) | - | - | - |
| 24 ¹)/6 | - | - | - |
| 6 | - | - | - |
| 24 - 8 | - | - | - |
| solid | stranded | ferrule | |
| with/without plastic sleeve | | | |
| 0.2 - 10 | 0.2 - 10 | 0.25 - 6 | 0.25 - 6 |
| 0.2 - 2.5 | 0.2 - 2.5 | 0.25 - 1.5 | - |
| 0.5 - 2.5 | | | |
| 10 | - | - | - |
| M4 | - | - | - |
| 1.5 - 1.8 | - | - | - |
| - | - | - | - |
| - | - | - | - |
| - | - | - | - |
| PA | - | - | - |
| V0 | - | - | - |

| Technical data | | | |
|-----------------------------|----------------------|---------------------------|---------|
| I _{max} [A] | U _{max} [V] | max. Ø [mm ²] | AWG |
| 24 | 400 ²) | 0.5 - 2.5 | 20 - 14 |
| IEC | | | |
| UL/CUL | CSA | IEC/EN 60079-7 | |
| 400 ²) | - | - | - |
| 24/2.5 | - | - | - |
| 6 | - | - | - |
| 20 - 14 | - | - | - |
| solid | stranded | ferrule | |
| with/without plastic sleeve | | | |
| - | 0.5 - 2.5 | - | - |
| - | - | - | - |
| 0.5 - 0.6 | - | - | - |
| PA | - | - | - |
| V0 | - | - | - |

| Technical data | | | |
|-----------------------------|----------|---------------------------|-----|
| | | max. Ø [mm ²] | AWG |
| | | - | - |
| IEC | | | |
| UL/CUL | CSA | IEC/EN 60079-7 | |
| - | - | - | - |
| - | - | - | - |
| - | - | - | - |
| - | - | - | - |
| solid | stranded | ferrule | |
| with/without plastic sleeve | | | |
| - | - | - | - |
| - | - | - | - |
| PA | - | - | - |
| V0 | - | - | - |

| Ordering data | | |
|---------------|-----------|-------------|
| Type | Order No. | Pcs. / Pkt. |
| UTRE 6-2/C19 | 3069430 | 1 |

| Ordering data | | |
|---------------|-----------|-------------|
| Type | Order No. | Pcs. / Pkt. |
| FTPR-2/C19 | 3069491 | 1 |
| FTP-2/C19 | 3069478 | 1 |
| FTP-2/1 | 3069469 | 1 |

| Ordering data | | |
|---------------|-----------|-------------|
| Type | Order No. | Pcs. / Pkt. |
| FBP-2/C19 | 3069504 | 1 |

| Accessories | | | |
|-------------|-------------|---------|----|
| AP-ME | METER | 3034361 | 10 |
| APH-ME | | 3034374 | 10 |
| APT-ME | | 3034358 | 10 |
| SF-SL | 0,8X4,0-100 | 1212551 | 10 |

| Accessories | | | |
|---------------------|--|---------|-----|
| PSBJ-URTK 6 FARBLOS | | 3026450 | 10 |
| PSBJ-URTK 6 RD | | 3026719 | 10 |
| PSBJ-URTK 6 BU | | 3026434 | 10 |
| PSBJ-URTK 6 YE | | 3026405 | 10 |
| PSBJ-URTK 6 GN | | 3026418 | 10 |
| PSBJ-URTK 6 VT | | 3026421 | 10 |
| PSBJ-URTK 6 BK | | 3026447 | 10 |
| PSBJ-URTK 6 GY | | 3026612 | 10 |
| PSBJ-URTK 6 BN | | 3026971 | 10 |
| C-FCI 1,5/M3 | | 3240032 | 100 |
| C-FCI 2,5/M3 | | 3240037 | 100 |
| C-RCI 1,5/M3 | | 3240016 | 100 |
| C-RCI 2,5/M3 | | 3240021 | 100 |

| Accessories | | | |
|-------------|--|--|--|
|-------------|--|--|--|

UC-TM 8, UCT-TM 8, ZB 8 or TMT (EX9,5)R (see Catalog 5)

UC-TM 8, UCT-TM 8, ZB 8 or TMT (EX9,5)R (see Catalog 5)

UC-TM 8, UCT-TM 8, ZB 8 or TMT (EX9,5)R (see Catalog 5)

Modular terminal blocks

FAME plug-in test system

Test terminal strip with UT ... screw connection, VDE type D19, for wall and DIN rail mounting

The **VDE D19** version described here is suitable as a plug-in test system for electromechanical differential protection for transformers.

- The test plugs are assembled with jumpers and contact tab lengths according to the circuit diagram
- A transparent covering hood protects the jumpers. The covering hood can only be removed by dismantling the test plug
- All VDE-specified 7, 14, and 19-pos. versions are supplied with exclusive coding for the matching test plug and blind plug
- The components are supplied pre-marked according to the VDE Directive
- Test signals can be connected with touch-proof safety test leads (CAT III and IV/1000 V according to EN 61010-031)
- The test plugs are equipped with two gray test sockets per position, for further color versions, see the range of accessories
- Additional test leads, assembled with ring and fork-type cable lugs, can be attached with test sockets
- Other VDE versions available on request

| Notes: |
|---|
| To create panel cutouts, see phoenixcontact.net/products . |
| ¹⁾ Derating curve available on request. |
| ²⁾ Rated surge voltage of 5 kV. |

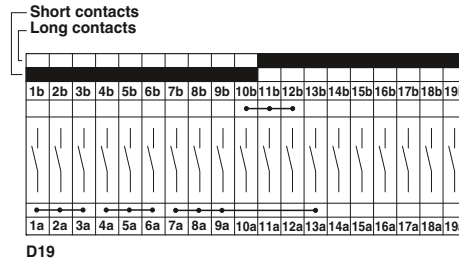

6 (10) mm², 30 A, test terminal strip, for wall mounting, VDE coded type D19

| Max. electrical data | |
|---|--|
| Rated data | |
| Rated voltage | [V] 400 ²⁾ |
| Nominal current / cross section | [A] / [mm ²] 24 ¹⁾ /6 |
| Rated cross section | [mm ²] 6 |
| Cross section range | AWG 24 - 8 |
| Connection capacity | |
| 1 conductor | [mm ²] 0.2 - 10 |
| 2 conductors (of the same type) | [mm ²] 0.2 - 2.5 |
| 2 stranded conductors with a TWIN ferrule | [mm ²] 0.2 - 2.5 |
| General data | |
| Stripping length | [mm] 10 |
| Screw thread | M4 |
| Tightening torque | [Nm] 1.5 - 1.8 |
| Tightening torque for wall fastening | [Nm] 0.8 - 1 |
| Panel thickness | [mm] 1 - 4 |
| Tightening torque: test socket screw | [Nm] - |
| Insulating material | PA |
| Inflammability class according to UL 94 | V0 |

| Technical data | | | |
|----------------------|-------------------------|-----------------------------|----------------|
| I _{max} [A] | U _{max} [V] | max. Ø [mm ²] | AWG |
| 30 | 400²⁾ | 0.2 - 10 | 24 - 8 |
| IEC 60947-7-1 | UL/CUL | CSA | IEC/EN 60079-7 |
| Connection capacity | | ferrule | |
| solid | stranded | with/without plastic sleeve | |
| 0.2 - 10 | 0.2 - 10 | 0.25 - 6 | 0.25 - 6 |
| 0.2 - 2.5 | 0.2 - 2.5 | 0.25 - 1.5 | - |
| | | | 0.5 - 2.5 |

| Description | Color |
|---|-------|
| Test terminal strip , for wall mounting | gray |
| Test terminal strip , for mounting on NS 35... | gray |
| Test plug , with twist grip | gray |
| With standard handle | gray |
| Test plug , 1-pos., with cover | gray |
| Blind plug , sealable | gray |

| Ordering data | | |
|---------------------|----------------|-------------|
| Type | Order No. | Pcs. / Pkt. |
| UTWE 6-2/D19 | 3069418 | 1 |

| | |
|--|---|
| Test socket , insulated | transparent red blue yellow green violet black gray brown |
| Cover profile , supply length 1 m | transparent |
| Cover profile holder , can be snapped on and sealed | gray |
| Cover profile , supply length 1 m | transparent |
| End brackets , for AP-ME cover profile, sealable, with storage option for jumpers | gray |
| Holder , for AP-ME cover profile | gray |
| Fork-type cable lug , insulated according to UL | red blue |
| Ring cable lug , insulated according to UL | red blue |

| Accessories | | |
|--------------------------|----------------|-----------|
| AP RSC-T | 3059139 | 10 |
| APH-UTWE 6-2 | 3069057 | 10 |
| SF-SL 0,8X4,0-100 | 1212551 | 10 |

| Screwdriver |
|--------------------------------|
| Lateral groove labeling |

| |
|--|
| UC-TM 8, UCT-TM 8, ZB 8 or TMT (EX9,5)R (see Catalog 5) |
|--|



6 (10) mm², 30 A, test terminal strip, for DIN rail mounting, VDE coded type D19



24 A, test plug, bridge assignment according to circuit diagram, VDE coded type D19



Blind plug, VDE coded type D19

| Technical data | | | |
|-----------------------------|----------------------|---------------------------|----------|
| I _{max} [A] | U _{max} [V] | max. Ø [mm ²] | AWG |
| 30 | 400 ²) | 0.2 - 10 | 24 - 8 |
| IEC 60947-7-1 | | | |
| IEC | | | |
| UL/CUL | CSA | IEC/EN 60079-7 | |
| 400 ²) | - | - | - |
| 24 ¹)/6 | - | - | - |
| 6 | - | - | - |
| 24 - 8 | - | - | - |
| solid | stranded | ferrule | |
| with/without plastic sleeve | | | |
| 0.2 - 10 | 0.2 - 10 | 0.25 - 6 | 0.25 - 6 |
| 0.2 - 2.5 | 0.2 - 2.5 | 0.25 - 1.5 | - |
| 0.5 - 2.5 | | | |
| 10 | - | - | - |
| M4 | - | - | - |
| 1.5 - 1.8 | - | - | - |
| - | - | - | - |
| - | - | - | - |
| - | - | - | - |
| PA | - | - | - |
| V0 | - | - | - |

| Technical data | | | |
|-----------------------------|----------------------|---------------------------|---------|
| I _{max} [A] | U _{max} [V] | max. Ø [mm ²] | AWG |
| 24 | 400 ²) | 0.5 - 2.5 | 20 - 14 |
| IEC | | | |
| UL/CUL | CSA | IEC/EN 60079-7 | |
| 400 ²) | - | - | - |
| 24/2.5 | - | - | - |
| 6 | - | - | - |
| 20 - 14 | - | - | - |
| solid | stranded | ferrule | |
| with/without plastic sleeve | | | |
| - | 0.5 - 2.5 | - | - |
| - | - | - | - |
| 0.5 - 0.6 | - | - | - |
| PA | - | - | - |
| V0 | - | - | - |

| Technical data | | | |
|-----------------------------|----------|---------------------------|-----|
| | | max. Ø [mm ²] | AWG |
| | | - | - |
| IEC | | | |
| UL/CUL | CSA | IEC/EN 60079-7 | |
| - | - | - | - |
| - | - | - | - |
| - | - | - | - |
| - | - | - | - |
| solid | stranded | ferrule | |
| with/without plastic sleeve | | | |
| - | - | - | - |
| - | - | - | - |
| PA | - | - | - |
| V0 | - | - | - |

| Ordering data | | |
|---------------|-----------|-------------|
| Type | Order No. | Pcs. / Pkt. |
| UTRE 6-2/D19 | 3069431 | 1 |

| Ordering data | | |
|---------------|-----------|-------------|
| Type | Order No. | Pcs. / Pkt. |
| FTPR-2/D19 | 3069492 | 1 |
| FTP-2/D19 | 3069479 | 1 |
| FTP-2/1 | 3069469 | 1 |

| Ordering data | | |
|---------------|-----------|-------------|
| Type | Order No. | Pcs. / Pkt. |
| FBP-2/D19 | 3069671 | 1 |

| Accessories | | | |
|-------------|-------------|---------|----|
| AP-ME | METER | 3034361 | 10 |
| APH-ME | | 3034374 | 10 |
| APT-ME | | 3034358 | 10 |
| SF-SL | 0,8X4,0-100 | 1212551 | 10 |

| Accessories | | | |
|---------------------|--|---------|-----|
| PSBJ-URTK 6 FARBLOS | | 3026450 | 10 |
| PSBJ-URTK 6 RD | | 3026719 | 10 |
| PSBJ-URTK 6 BU | | 3026434 | 10 |
| PSBJ-URTK 6 YE | | 3026405 | 10 |
| PSBJ-URTK 6 GN | | 3026418 | 10 |
| PSBJ-URTK 6 VT | | 3026421 | 10 |
| PSBJ-URTK 6 BK | | 3026447 | 10 |
| PSBJ-URTK 6 GY | | 3026612 | 10 |
| PSBJ-URTK 6 BN | | 3026971 | 10 |
| C-FCI 1,5/M3 | | 3240032 | 100 |
| C-FCI 2,5/M3 | | 3240037 | 100 |
| C-RCI 1,5/M3 | | 3240016 | 100 |
| C-RCI 2,5/M3 | | 3240021 | 100 |

| Accessories | | | |
|-------------|--|--|--|
|-------------|--|--|--|

UC-TM 8, UCT-TM 8, ZB 8 or TMT (EX9,5)R (see Catalog 5)

UC-TM 8, UCT-TM 8, ZB 8 or TMT (EX9,5)R (see Catalog 5)

UC-TM 8, UCT-TM 8, ZB 8 or TMT (EX9,5)R (see Catalog 5)

FAME plug-in test system

Test terminal strip with UT ... screw connection, VDE type F19, for wall and DIN rail mounting

The **VDE F19** version described here is suitable as a plug-in test system in electromechanical differential protection for transformers, generators, motors, and cables.

- The test plugs are assembled with jumpers and contact tab lengths according to the circuit diagram
- A transparent covering hood protects the jumpers. The covering hood can only be removed by dismantling the test plug
- All VDE-specified 7, 14, and 19-pos. versions are supplied with exclusive coding for the matching test plug and blind plug
- The components are supplied pre-marked according to the VDE Directive
- Test signals can be connected with touch-proof safety test leads (CAT III and IV/1000 V according to EN 61010-031)
- The test plugs are equipped with two gray test sockets per position, for further color versions, see the range of accessories
- Additional test leads, assembled with ring and fork-type cable lugs, can be attached with test sockets
- Other VDE versions available on request

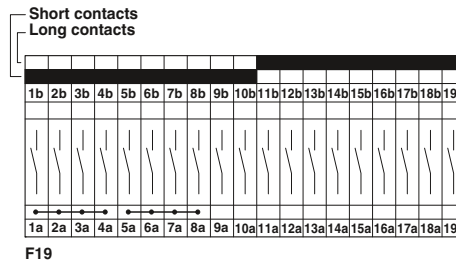

6 (10) mm², 30 A, test terminal strip, for wall mounting, VDE coded type F19

| Notes: | |
|---|--|
| To create panel cutouts, see phoenixcontact.net/products . | |
| 1) Derating curve available on request. | |
| 2) Rated surge voltage of 5 kV. | |

| Max. electrical data | |
|---|--|
| Rated data | |
| Rated voltage | [V] 400 ²⁾ |
| Nominal current / cross section | [A] / [mm ²] 24 ¹⁾ /6 |
| Rated cross section | [mm ²] 6 |
| Cross section range | AWG 24 - 8 |
| Connection capacity | |
| 1 conductor | [mm ²] 0.2 - 10 |
| 2 conductors (of the same type) | [mm ²] 0.2 - 2.5 |
| 2 stranded conductors with a TWIN ferrule | [mm ²] 0.25 - 1.5 |
| General data | |
| Stripping length | [mm] 10 |
| Screw thread | M4 |
| Tightening torque | [Nm] 1.5 - 1.8 |
| Tightening torque for wall fastening | [Nm] 0.8 - 1 |
| Panel thickness | [mm] 1 - 4 |
| Tightening torque: test socket screw | [Nm] - |
| Insulating material | PA |
| Inflammability class according to UL 94 | V0 |

| Technical data | | | |
|----------------|-------------------------|---------------------------------------|----------------|
| I_{max} [A] | U_{max} [V] | max. \varnothing [mm ²] | AWG |
| 30 | 400²⁾ | 0.2 - 10 | 24 - 8 |
| IEC 60947-7-1 | UL/CUL | CSA | IEC/EN 60079-7 |
| solid | | stranded | |
| | | ferrule | |
| | | with/without plastic sleeve | |
| 0.2 - 10 | 0.2 - 10 | 0.25 - 6 | 0.25 - 6 |
| 0.2 - 2.5 | 0.2 - 2.5 | 0.25 - 1.5 | - |
| | | | 0.5 - 2.5 |

| Description | Color |
|---|-------|
| Test terminal strip , for wall mounting | gray |
| Test terminal strip , for mounting on NS 35... | gray |
| Test plug , with twist grip | gray |
| With standard handle | gray |
| Test plug , 1-pos., with cover | gray |
| Blind plug , sealable | gray |

| Ordering data | | |
|---------------------|----------------|-------------|
| Type | Order No. | Pcs. / Pkt. |
| UTWE 6-2/F19 | 3069419 | 1 |

| | |
|--|---|
| Test socket , insulated | transparent red blue yellow green violet black gray brown |
| Cover profile , supply length 1 m | transparent |
| Cover profile holder , can be snapped on and sealed | gray |
| Cover profile , supply length 1 m | transparent |
| End brackets , for AP-ME cover profile, sealable, with storage option for jumpers | gray |
| Holder , for AP-ME cover profile | gray |
| Fork-type cable lug , insulated according to UL | red blue |
| Ring cable lug , insulated according to UL | red blue |

| Accessories | | |
|--------------------------|----------------|-----------|
| AP RSC-T | 3059139 | 10 |
| APH-UTWE 6-2 | 3069057 | 10 |
| SF-SL 0,8X4,0-100 | 1212551 | 10 |

| Screwdriver |
|--------------------------------|
| Lateral groove labeling |

| |
|--|
| UC-TM 8, UCT-TM 8, ZB 8 or TMT (EX9,5)R (see Catalog 5) |
|--|



6 (10) mm², 30 A, test terminal strip, for DIN rail mounting, VDE coded type F19



24 A, test plug, bridge assignment according to circuit diagram, VDE coded type F19



Blind plug, VDE coded type F19

| Technical data | | | |
|-----------------------------|----------------------|---------------------------|----------|
| I _{max} [A] | U _{max} [V] | max. Ø [mm ²] | AWG |
| 30 | 400 ²) | 0.2 - 10 | 24 - 8 |
| IEC 60947-7-1 | | | |
| IEC | | | |
| UL/CUL | CSA | IEC/EN 60079-7 | |
| 400 ²) | - | - | - |
| 24 ¹)/6 | - | - | - |
| 6 | - | - | - |
| 24 - 8 | - | - | - |
| solid | stranded | ferrule | |
| with/without plastic sleeve | | | |
| 0.2 - 10 | 0.2 - 10 | 0.25 - 6 | 0.25 - 6 |
| 0.2 - 2.5 | 0.2 - 2.5 | 0.25 - 1.5 | - |
| 0.5 - 2.5 | | | |
| 10 | - | - | - |
| M4 | - | - | - |
| 1.5 - 1.8 | - | - | - |
| - | - | - | - |
| - | - | - | - |
| - | - | - | - |
| 0.5 - 0.6 | - | - | - |
| PA | - | - | - |
| V0 | - | - | - |

| Technical data | | | |
|-----------------------------|----------------------|---------------------------|---------|
| I _{max} [A] | U _{max} [V] | max. Ø [mm ²] | AWG |
| 24 | 400 ²) | 0.5 - 2.5 | 20 - 14 |
| IEC | | | |
| UL/CUL | CSA | IEC/EN 60079-7 | |
| 400 ²) | - | - | - |
| 24/2.5 | - | - | - |
| 6 | - | - | - |
| 20 - 14 | - | - | - |
| solid | stranded | ferrule | |
| with/without plastic sleeve | | | |
| - | 0.5 - 2.5 | - | - |
| - | - | - | - |
| - | - | - | - |
| - | - | - | - |
| 0.5 - 0.6 | - | - | - |
| PA | - | - | - |
| V0 | - | - | - |

| Technical data | | | |
|-----------------------------|----------|---------------------------|-----|
| | | max. Ø [mm ²] | AWG |
| | | - | - |
| IEC | | | |
| UL/CUL | CSA | IEC/EN 60079-7 | |
| - | - | - | - |
| - | - | - | - |
| - | - | - | - |
| - | - | - | - |
| solid | stranded | ferrule | |
| with/without plastic sleeve | | | |
| - | - | - | - |
| - | - | - | - |
| - | - | - | - |
| - | - | - | - |
| PA | - | - | - |
| V0 | - | - | - |

| Ordering data | | |
|---------------|-----------|-------------|
| Type | Order No. | Pcs. / Pkt. |
| UTRE 6-2/F19 | 3069432 | 1 |

| Ordering data | | |
|---------------|-----------|-------------|
| Type | Order No. | Pcs. / Pkt. |
| FTPR-2/F19 | 3069493 | 1 |
| FTP-2/F19 | 3069480 | 1 |
| FTP-2/1 | 3069469 | 1 |

| Ordering data | | |
|---------------|-----------|-------------|
| Type | Order No. | Pcs. / Pkt. |
| FBP-2/F19 | 3069675 | 1 |

| Accessories | | | |
|-------------|-------------|---------|----|
| AP-ME | METER | 3034361 | 10 |
| APH-ME | | 3034374 | 10 |
| APT-ME | | 3034358 | 10 |
| SF-SL | 0,8X4,0-100 | 1212551 | 10 |

| Accessories | | | |
|---------------------|--|---------|-----|
| PSBJ-URTK 6 FARBLOS | | 3026450 | 10 |
| PSBJ-URTK 6 RD | | 3026719 | 10 |
| PSBJ-URTK 6 BU | | 3026434 | 10 |
| PSBJ-URTK 6 YE | | 3026405 | 10 |
| PSBJ-URTK 6 GN | | 3026418 | 10 |
| PSBJ-URTK 6 VT | | 3026421 | 10 |
| PSBJ-URTK 6 BK | | 3026447 | 10 |
| PSBJ-URTK 6 GY | | 3026612 | 10 |
| PSBJ-URTK 6 BN | | 3026971 | 10 |
| C-FCI 1,5/M3 | | 3240032 | 100 |
| C-FCI 2,5/M3 | | 3240037 | 100 |
| C-RCI 1,5/M3 | | 3240016 | 100 |
| C-RCI 2,5/M3 | | 3240021 | 100 |

| Accessories | | | |
|-------------|--|--|--|
|-------------|--|--|--|

UC-TM 8, UCT-TM 8, ZB 8 or TMT (EX9,5)R (see Catalog 5)

UC-TM 8, UCT-TM 8, ZB 8 or TMT (EX9,5)R (see Catalog 5)

UC-TM 8, UCT-TM 8, ZB 8 or TMT (EX9,5)R (see Catalog 5)

Modular terminal blocks

FAME plug-in test system

Test terminal strip with UT ... screw connection, VDE type G19, for wall and DIN rail mounting

The **VDE G19** version described here is suitable as a plug-in test system in digital differential protection for transformers.

- The test plugs are assembled with jumpers and contact tab lengths according to the circuit diagram
- A transparent covering hood protects the jumpers. The covering hood can only be removed by dismantling the test plug
- All VDE-specified 7, 14, and 19-pos. versions are supplied with exclusive coding for the matching test plug and blind plug
- The components are supplied pre-marked according to the VDE Directive
- Test signals can be connected with touch-proof safety test leads (CAT III and IV/1000 V according to EN 61010-031)
- The test plugs are equipped with two gray test sockets per position, for further color versions, see the range of accessories
- Additional test leads, assembled with ring and fork-type cable lugs, can be attached with test sockets
- Other VDE versions available on request

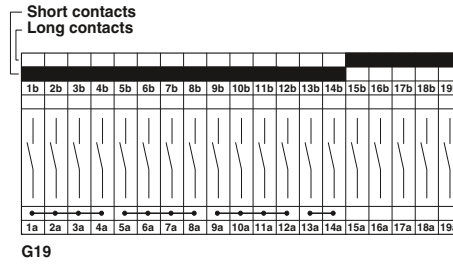

6 (10) mm², 30 A, test terminal strip, for wall mounting, VDE coded type G19

| Notes: |
|---|
| To create panel cutouts, see phoenixcontact.net/products . |
| 1) Derating curve available on request. |
| 2) Rated surge voltage of 5 kV. |

| Max. electrical data | |
|---|--|
| Rated data | |
| Rated voltage | [V] 400 ²⁾ |
| Nominal current / cross section | [A] / [mm ²] 24 ¹⁾ /6 |
| Rated cross section | [mm ²] 6 |
| Cross section range | AWG 24 - 8 |
| Connection capacity | |
| 1 conductor | [mm ²] 0.2 - 10 |
| 2 conductors (of the same type) | [mm ²] 0.2 - 2.5 |
| 2 stranded conductors with a TWIN ferrule | [mm ²] 0.25 - 1.5 |
| General data | |
| Stripping length | [mm] 10 |
| Screw thread | M4 |
| Tightening torque | [Nm] 1.5 - 1.8 |
| Tightening torque for wall fastening | [Nm] 0.8 - 1 |
| Panel thickness | [mm] 1 - 4 |
| Tightening torque: test socket screw | [Nm] - |
| Insulating material | PA |
| Inflammability class according to UL 94 | V0 |

| Technical data | | | |
|----------------------|----------------------|-----------------------------|----------------|
| I _{max} [A] | U _{max} [V] | max. Ø [mm ²] | AWG |
| 30 | 400 ²⁾ | 0.2 - 10 | 24 - 8 |
| IEC 60947-7-1 | UL/CUL | CSA | IEC/EN 60079-7 |
| solid | | stranded | |
| | | ferrule | |
| | | with/without plastic sleeve | |
| 0.2 - 10 | 0.2 - 10 | 0.25 - 6 | 0.25 - 6 |
| 0.2 - 2.5 | 0.2 - 2.5 | 0.25 - 1.5 | - |
| | | | 0.5 - 2.5 |

| Description | Color |
|---|-------|
| Test terminal strip, for wall mounting | gray |
| Test terminal strip, for mounting on NS 35... | gray |
| Test plug, with twist grip | gray |
| With standard handle | gray |
| Test plug, 1-pos., with cover | gray |
| Blind plug, sealable | gray |

| Ordering data | | |
|---------------|-----------|-------------|
| Type | Order No. | Pcs. / Pkt. |
| UTWE 6-2/G19 | 3069420 | 1 |

| | |
|--|---|
| Test socket, insulated | transparent red blue yellow green violet black gray brown |
| Cover profile, supply length 1 m | transparent |
| Cover profile holder, can be snapped on and sealed | gray |
| Cover profile, supply length 1 m | transparent |
| End brackets, for AP-ME cover profile, sealable, with storage option for jumpers | gray |
| Holder, for AP-ME cover profile | gray |
| Fork-type cable lug, insulated according to UL | red blue |
| Ring cable lug, insulated according to UL | red blue |

| Accessories | | |
|-------------------|---------|----|
| AP RSC-T | 3059139 | 10 |
| APH-UTWE 6-2 | 3069057 | 10 |
| SF-SL 0,8X4,0-100 | 1212551 | 10 |

| Screwdriver |
|-------------------------|
| Lateral groove labeling |

| |
|---|
| UC-TM 8, UCT-TM 8, ZB 8 or TMT (EX9,5)R (see Catalog 5) |
|---|



6 (10) mm², 30 A, test terminal strip, for DIN rail mounting, VDE coded type G19



24 A, test plug, bridge assignment according to circuit diagram, VDE coded type G19



Blind plug, VDE coded type G19

| Technical data | | | |
|----------------------|----------------------|-------------------------------------|----------------|
| I _{max} [A] | U _{max} [V] | max. Ø [mm ²] | AWG |
| 30 | 400 ²) | 0.2 - 10 | 24 - 8 |
| IEC 60947-7-1 | | | |
| IEC | UL/CUL | CSA | IEC/EN 60079-7 |
| 400 ²) | - | - | - |
| 24 ¹)/6 | - | - | - |
| 6 | - | - | - |
| 24 - 8 | - | - | - |
| solid | stranded | ferrule with/without plastic sleeve | |
| 0.2 - 10 | 0.2 - 10 | 0.25 - 6 | 0.25 - 6 |
| 0.2 - 2.5 | 0.2 - 2.5 | 0.25 - 1.5 | - |
| | | | 0.5 - 2.5 |
| 10 | | | |
| M4 | | | |
| 1.5 - 1.8 | | | |
| - | | | |
| - | | | |
| - | | | |
| 0.5 - 0.6 | | | |
| PA | | | |
| V0 | | | |

| Technical data | | | |
|----------------------|----------------------|-------------------------------------|---------|
| I _{max} [A] | U _{max} [V] | max. Ø [mm ²] | AWG |
| 24 | 400 ²) | 0.5 - 2.5 | 20 - 14 |
| IEC | | | |
| UL/CUL | CSA | IEC/EN 60079-7 | |
| 400 ²) | - | - | - |
| 24/2.5 | - | - | - |
| 6 | - | - | - |
| 20 - 14 | - | - | - |
| solid | stranded | ferrule with/without plastic sleeve | |
| - | 0.5 - 2.5 | - | - |
| - | - | - | - |
| - | | | |
| - | | | |
| 0.5 - 0.6 | | | |
| PA | | | |
| V0 | | | |

| Technical data | | | |
|----------------|----------|-------------------------------------|-----|
| | | max. Ø [mm ²] | AWG |
| | | - | - |
| IEC | | | |
| UL/CUL | CSA | IEC/EN 60079-7 | |
| - | - | - | - |
| - | - | - | - |
| - | - | - | - |
| - | - | - | - |
| solid | stranded | ferrule with/without plastic sleeve | |
| - | - | - | - |
| - | - | - | - |
| - | | | |
| - | | | |
| PA | | | |
| V0 | | | |

| Ordering data | | |
|---------------|-----------|-------------|
| Type | Order No. | Pcs. / Pkt. |
| UTRE 6-2/G19 | 3069433 | 1 |

| Ordering data | | |
|---------------|-----------|-------------|
| Type | Order No. | Pcs. / Pkt. |
| FTPR-2/G19 | 3069494 | 1 |
| FTP-2/G19 | 3069481 | 1 |
| FTP-2/1 | 3069469 | 1 |

| Ordering data | | |
|---------------|-----------|-------------|
| Type | Order No. | Pcs. / Pkt. |
| FBP-2/G19 | 3069676 | 1 |

| Accessories | | | |
|-------------|-------------|---------|----|
| AP-ME | METER | 3034361 | 10 |
| APH-ME | | 3034374 | 10 |
| APT-ME | | 3034358 | 10 |
| SF-SL | 0,8X4,0-100 | 1212551 | 10 |

| Accessories | | | |
|---------------------|--|---------|-----|
| PSBJ-URTK 6 FARBLOS | | 3026450 | 10 |
| PSBJ-URTK 6 RD | | 3026719 | 10 |
| PSBJ-URTK 6 BU | | 3026434 | 10 |
| PSBJ-URTK 6 YE | | 3026405 | 10 |
| PSBJ-URTK 6 GN | | 3026418 | 10 |
| PSBJ-URTK 6 VT | | 3026421 | 10 |
| PSBJ-URTK 6 BK | | 3026447 | 10 |
| PSBJ-URTK 6 GY | | 3026612 | 10 |
| PSBJ-URTK 6 BN | | 3026971 | 10 |
| C-FCI 1,5/M3 | | 3240032 | 100 |
| C-FCI 2,5/M3 | | 3240037 | 100 |
| C-RCI 1,5/M3 | | 3240016 | 100 |
| C-RCI 2,5/M3 | | 3240021 | 100 |

| Accessories | | | |
|-------------|--|--|--|
|-------------|--|--|--|

UC-TM 8, UCT-TM 8, ZB 8 or TMT (EX9,5)R (see Catalog 5)

UC-TM 8, UCT-TM 8, ZB 8 or TMT (EX9,5)R (see Catalog 5)

UC-TM 8, UCT-TM 8, ZB 8 or TMT (EX9,5)R (see Catalog 5)

Modular terminal blocks

FAME plug-in test system

Test terminal strip with UT ... screw connection, VDE type H19, for wall and DIN rail mounting

The **VDE H19** version described here is suitable as a plug-in test system in overcurrent directional protection and distance protection as system protection.

- The test plugs are assembled with jumpers and contact tab lengths according to the circuit diagram
- A transparent covering hood protects the jumpers. The covering hood can only be removed by dismantling the test plug
- All VDE-specified 7, 14, and 19-pos. versions are supplied with exclusive coding for the matching test plug and blind plug
- The components are supplied pre-marked according to the VDE Directive
- Test signals can be connected with touch-proof safety test leads (CAT III and IV/1000 V according to EN 61010-031)
- The test plugs are equipped with two gray test sockets per position, for further color versions, see the range of accessories
- Additional test leads, assembled with ring and fork-type cable lugs, can be attached with test sockets
- Other VDE versions available on request

| Notes: |
|---|
| To create panel cutouts, see phoenixcontact.net/products . |
| ¹⁾ Derating curve available on request. |
| ²⁾ Rated surge voltage of 5 kV. |

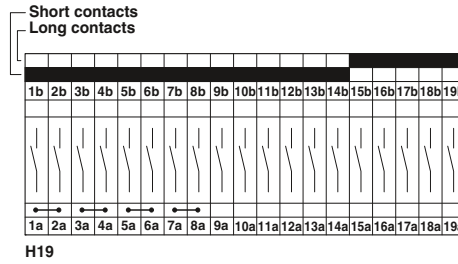

| Max. electrical data | |
|---|--|
| Rated data | |
| Rated voltage | [V] 400 ²⁾ |
| Nominal current / cross section | [A] / [mm ²] 24 ¹⁾ /6 |
| Rated cross section | [mm ²] 6 |
| Cross section range | AWG 24 - 8 |
| Connection capacity | |
| 1 conductor | [mm ²] 0.2 - 10 |
| 2 conductors (of the same type) | [mm ²] 0.2 - 2.5 |
| 2 stranded conductors with a TWIN ferrule | [mm ²] 0.2 - 2.5 |
| General data | |
| Stripping length | [mm] 10 |
| Screw thread | M4 |
| Tightening torque | [Nm] 1.5 - 1.8 |
| Tightening torque for wall fastening | [Nm] 0.8 - 1 |
| Panel thickness | [mm] 1 - 4 |
| Tightening torque: test socket screw | [Nm] - |
| Insulating material | PA |
| Inflammability class according to UL 94 | V0 |

| Description | Color |
|---|-------|
| Test terminal strip , for wall mounting | gray |
| Test terminal strip , for mounting on NS 35... | gray |
| Test plug , with twist grip | gray |
| With standard handle | gray |
| Test plug , 1-pos., with cover | gray |
| Blind plug , sealable | gray |

| | |
|--|---|
| Test socket , insulated | transparent red blue yellow green violet black gray brown |
| Cover profile , supply length 1 m | transparent |
| Cover profile holder , can be snapped on and sealed | gray |
| Cover profile , supply length 1 m | transparent |
| End brackets , for AP-ME cover profile, sealable, with storage option for jumpers | gray |
| Holder , for AP-ME cover profile | gray |
| Fork-type cable lug , insulated according to UL | red blue |
| Ring cable lug , insulated according to UL | red blue |

| | |
|--------------------------------|---|
| Screwdriver | SF-SL 0,8X4,0-100 |
| Lateral groove labeling | UC-TM 8, UCT-TM 8, ZB 8 or TMT (EX9,5)R (see Catalog 5) |



6 (10) mm², 30 A, test terminal strip, for wall mounting, VDE coded type H19

| Technical data | | | |
|----------------------|-------------------------|-----------------------------|----------------|
| I _{max} [A] | U _{max} [V] | max. Ø [mm ²] | AWG |
| 30 | 400²⁾ | 0.2 - 10 | 24 - 8 |
| IEC 60947-7-1 | | | |
| IEC | UL/CUL | CSA | IEC/EN 60079-7 |
| Connection capacity | | ferrule | |
| solid | stranded | with/without plastic sleeve | |
| 0.2 - 10 | 0.2 - 10 | 0.25 - 6 | 0.25 - 6 |
| 0.2 - 2.5 | 0.2 - 2.5 | 0.25 - 1.5 | - |
| | | | 0.5 - 2.5 |

| Ordering data | | |
|---------------------|----------------|-------------|
| Type | Order No. | Pcs. / Pkt. |
| UTWE 6-2/H19 | 3069421 | 1 |

| Accessories | | |
|--|----------------|-----------|
| AP RSC-T | 3059139 | 10 |
| APH-UTWE 6-2 | 3069057 | 10 |
| SF-SL 0,8X4,0-100 | 1212551 | 10 |
| UC-TM 8, UCT-TM 8, ZB 8 or TMT (EX9,5)R (see Catalog 5) | | |



6 (10) mm², 30 A, test terminal strip, for DIN rail mounting, VDE coded type H19



24 A, test plug, bridge assignment according to circuit diagram, VDE coded type H19



Blind plug, VDE coded type H19

| Technical data | | | |
|----------------------|----------------------|-------------------------------------|----------------|
| I _{max} [A] | U _{max} [V] | max. Ø [mm ²] | AWG |
| 30 | 400 ²) | 0.2 - 10 | 24 - 8 |
| IEC 60947-7-1 | | | |
| IEC | UL/CUL | CSA | IEC/EN 60079-7 |
| 400 ²) | - | - | - |
| 24 ¹)/6 | - | - | - |
| 6 | - | - | - |
| 24 - 8 | - | - | - |
| solid | stranded | ferrule with/without plastic sleeve | |
| 0.2 - 10 | 0.2 - 10 | 0.25 - 6 | 0.25 - 6 |
| 0.2 - 2.5 | 0.2 - 2.5 | 0.25 - 1.5 | - |
| | | | 0.5 - 2.5 |
| 10 | | | |
| M4 | | | |
| 1.5 - 1.8 | | | |
| - | | | |
| - | | | |
| - | | | |
| PA | | | |
| V0 | | | |

| Technical data | | | |
|----------------------|----------------------|-------------------------------------|---------|
| I _{max} [A] | U _{max} [V] | max. Ø [mm ²] | AWG |
| 24 | 400 ²) | 0.5 - 2.5 | 20 - 14 |
| IEC | | | |
| UL/CUL | CSA | IEC/EN 60079-7 | |
| 400 ²) | - | - | - |
| 24/2.5 | - | - | - |
| 6 | - | - | - |
| 20 - 14 | - | - | - |
| solid | stranded | ferrule with/without plastic sleeve | |
| - | 0.5 - 2.5 | - | - |
| - | - | - | - |
| | | | |
| 0.5 - 0.6 | | | |
| PA | | | |
| V0 | | | |

| Technical data | | | |
|----------------|----------|-------------------------------------|-----|
| | | max. Ø [mm ²] | AWG |
| | | - | - |
| IEC | | | |
| UL/CUL | CSA | IEC/EN 60079-7 | |
| - | - | - | - |
| - | - | - | - |
| - | - | - | - |
| - | - | - | - |
| solid | stranded | ferrule with/without plastic sleeve | |
| - | - | - | - |
| - | - | - | - |
| | | | |
| PA | | | |
| V0 | | | |

| Ordering data | | |
|---------------|-----------|-------------|
| Type | Order No. | Pcs. / Pkt. |
| UTRE 6-2/H19 | 3069434 | 1 |

| Ordering data | | |
|---------------|-----------|-------------|
| Type | Order No. | Pcs. / Pkt. |
| FTPR-2/H19 | 3069495 | 1 |
| FTP-2/H19 | 3069482 | 1 |
| FTP-2/1 | 3069469 | 1 |

| Ordering data | | |
|---------------|-----------|-------------|
| Type | Order No. | Pcs. / Pkt. |
| FBP-2/H19 | 3069677 | 1 |

| Accessories | | | |
|-------------|-------------|---------|----|
| AP-ME | METER | 3034361 | 10 |
| APH-ME | | 3034374 | 10 |
| APT-ME | | 3034358 | 10 |
| SF-SL | 0,8X4,0-100 | 1212551 | 10 |

| Accessories | | | |
|---------------------|--|---------|-----|
| PSBJ-URTK 6 FARBLOS | | 3026450 | 10 |
| PSBJ-URTK 6 RD | | 3026719 | 10 |
| PSBJ-URTK 6 BU | | 3026434 | 10 |
| PSBJ-URTK 6 YE | | 3026405 | 10 |
| PSBJ-URTK 6 GN | | 3026418 | 10 |
| PSBJ-URTK 6 VT | | 3026421 | 10 |
| PSBJ-URTK 6 BK | | 3026447 | 10 |
| PSBJ-URTK 6 GY | | 3026612 | 10 |
| PSBJ-URTK 6 BN | | 3026971 | 10 |
| C-FCI 1,5/M3 | | 3240032 | 100 |
| C-FCI 2,5/M3 | | 3240037 | 100 |
| C-RCI 1,5/M3 | | 3240016 | 100 |
| C-RCI 2,5/M3 | | 3240021 | 100 |

| Accessories | | | |
|-------------|--|--|--|
|-------------|--|--|--|

UC-TM 8, UCT-TM 8, ZB 8 or TMT (EX9,5)R (see Catalog 5)

UC-TM 8, UCT-TM 8, ZB 8 or TMT (EX9,5)R (see Catalog 5)

UC-TM 8, UCT-TM 8, ZB 8 or TMT (EX9,5)R (see Catalog 5)

Modular terminal blocks

FAME plug-in test system

Test terminal strip with UT ... screw connection, VDE type I19, for wall and DIN rail mounting

The **VDE I19** version described here is suitable as a plug-in test system in medium voltage, outlet, and coupling protection, including selective ground fault detection.

- The test plugs are assembled with jumpers and contact tab lengths according to the circuit diagram
- A transparent covering hood protects the jumpers. The covering hood can only be removed by dismantling the test plug
- All VDE-specified 7, 14, and 19-pos. versions are supplied with exclusive coding for the matching test plug and blind plug
- The components are supplied pre-marked according to the VDE Directive
- Test signals can be connected with touch-proof safety test leads (CAT III and IV/1000 V according to EN 61010-031)
- The test plugs are equipped with two gray test sockets per position, for further color versions, see the range of accessories
- Additional test leads, assembled with ring and fork-type cable lugs, can be attached with test sockets
- Other VDE versions available on request

Notes:

To create panel cutouts, see phoenixcontact.net/products.

¹⁾ Derating curve available on request.

²⁾ Rated surge voltage of 5 kV.

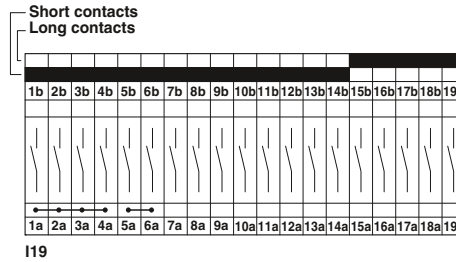

6 (10) mm², 30 A, test terminal strip, for wall mounting, VDE coded type I19

Max. electrical data

Max. electrical data

Rated data

| | | |
|---------------------------------|--------------------------|---------------------|
| Rated voltage | [V] | 400 ²⁾ |
| Nominal current / cross section | [A] / [mm ²] | 24 ¹⁾ /6 |
| Rated cross section | [mm ²] | 6 |
| Cross section range | AWG | 24 - 8 |

Connection capacity

| | | |
|---|--------------------|-----------|
| 1 conductor | [mm ²] | 0.2 - 10 |
| 2 conductors (of the same type) | [mm ²] | 0.2 - 2.5 |
| 2 stranded conductors with a TWIN ferrule | [mm ²] | 0.2 - 2.5 |

General data

| | | |
|---|------|-----------|
| Stripping length | [mm] | 10 |
| Screw thread | | M4 |
| Tightening torque | [Nm] | 1.5 - 1.8 |
| Tightening torque for wall fastening | [Nm] | 0.8 - 1 |
| Panel thickness | [mm] | 1 - 4 |
| Tightening torque: test socket screw | [Nm] | - |
| Insulating material | | PA |
| Inflammability class according to UL 94 | | V0 |

Technical data

| I _{max} [A] | U _{max} [V] | max. Ø [mm ²] | AWG |
|-----------------------------|----------------------|---------------------------|----------------|
| 30 | 400 ²⁾ | 0.2 - 10 | 24 - 8 |
| IEC 60947-7-1 | | | |
| IEC | UL/CUL | CSA | IEC/EN 60079-7 |
| with/without plastic sleeve | | | |
| solid | stranded | ferrule | |
| 0.2 - 10 | 0.2 - 10 | 0.25 - 6 | 0.25 - 6 |
| 0.2 - 2.5 | 0.2 - 2.5 | 0.25 - 1.5 | - |
| | | | 0.5 - 2.5 |

Ordering data

| Type | Order No. | Pcs. / Pkt. |
|--------------|-----------|-------------|
| UTWE 6-2/I19 | 3069422 | 1 |

Accessories

| Description | Color | Type | Order No. | Pcs. / Pkt. |
|--|---|---|-----------|-------------|
| Test terminal strip , for wall mounting | gray | UTWE 6-2/I19 | 3069422 | 1 |
| Test terminal strip , for mounting on NS 35... | gray | | | |
| Test plug , with twist grip | gray | | | |
| With standard handle | gray | | | |
| Test plug , 1-pos., with cover | gray | | | |
| Blind plug , sealable | gray | | | |
| Test socket , insulated | transparent red blue yellow green violet black gray brown | | | |
| Cover profile , supply length 1 m | transparent | AP RSC-T | 3059139 | 10 |
| Cover profile holder , can be snapped on and sealed | gray | APH-UTWE 6-2 | 3069057 | 10 |
| Cover profile , supply length 1 m | transparent | | | |
| End brackets , for AP-ME cover profile, sealable, with storage option for jumpers | gray | | | |
| Holder , for AP-ME cover profile | gray | | | |
| Fork-type cable lug , insulated according to UL | red blue | | | |
| Ring cable lug , insulated according to UL | red blue | | | |
| Screwdriver | | SF-SL 0,8X4,0-100 | 1212551 | 10 |
| Lateral groove labeling | | UC-TM 8, UCT-TM 8, ZB 8 or TMT (EX9,5)R (see Catalog 5) | | |



6 (10) mm², 30 A, test terminal strip, for DIN rail mounting, VDE coded type I19



24 A, test plug, bridge assignment according to circuit diagram, VDE coded type I19



Blind plug, VDE coded type I19

| Technical data | | | |
|----------------------|----------------------|-----------------------------|----------------|
| I _{max} [A] | U _{max} [V] | max. Ø [mm ²] | AWG |
| 30 | 400 ²) | 0.2 - 10 | 24 - 8 |
| IEC 60947-7-1 | | | |
| IEC | UL/CUL | CSA | IEC/EN 60079-7 |
| 400 ²) | - | - | - |
| 24 ¹)/6 | - | - | - |
| 6 | - | - | - |
| 24 - 8 | - | - | - |
| solid | stranded | ferrule | |
| | | with/without plastic sleeve | |
| 0.2 - 10 | 0.2 - 10 | 0.25 - 6 | 0.25 - 6 |
| 0.2 - 2.5 | 0.2 - 2.5 | 0.25 - 1.5 | - |
| | | 0.5 - 2.5 | |
| 10 | - | - | - |
| M4 | - | - | - |
| 1.5 - 1.8 | - | - | - |
| - | - | - | - |
| - | - | - | - |
| - | - | - | - |
| PA | - | - | - |
| V0 | - | - | - |

| Technical data | | | |
|----------------------|----------------------|-----------------------------|---------|
| I _{max} [A] | U _{max} [V] | max. Ø [mm ²] | AWG |
| 24 | 400 ²) | 0.5 - 2.5 | 20 - 14 |
| IEC | | | |
| UL/CUL | CSA | IEC/EN 60079-7 | |
| 400 ²) | - | - | - |
| 24/2.5 | - | - | - |
| 6 | - | - | - |
| 20 - 14 | - | - | - |
| solid | stranded | ferrule | |
| | | with/without plastic sleeve | |
| - | 0.5 - 2.5 | - | - |
| - | - | - | - |
| 0.5 - 0.6 | - | - | - |
| PA | - | - | - |
| V0 | - | - | - |

| Technical data | | | |
|----------------|----------|-----------------------------|-----|
| | | max. Ø [mm ²] | AWG |
| | | - | - |
| IEC | | | |
| UL/CUL | CSA | IEC/EN 60079-7 | |
| - | - | - | - |
| - | - | - | - |
| - | - | - | - |
| - | - | - | - |
| solid | stranded | ferrule | |
| | | with/without plastic sleeve | |
| - | - | - | - |
| - | - | - | - |
| PA | - | - | - |
| V0 | - | - | - |

| Ordering data | | |
|---------------|-----------|-------------|
| Type | Order No. | Pcs. / Pkt. |
| UTRE 6-2/I19 | 3069435 | 1 |

| Ordering data | | |
|---------------|-----------|-------------|
| Type | Order No. | Pcs. / Pkt. |
| FTPR-2/I19 | 3069496 | 1 |
| FTP-2/I19 | 3069483 | 1 |
| FTP-2/1 | 3069469 | 1 |

| Ordering data | | |
|---------------|-----------|-------------|
| Type | Order No. | Pcs. / Pkt. |
| FBP-2/I19 | 3069678 | 1 |

| Accessories | | | |
|-------------|-------------|---------|----|
| AP-ME | METER | 3034361 | 10 |
| APH-ME | | 3034374 | 10 |
| APT-ME | | 3034358 | 10 |
| SF-SL | 0,8X4,0-100 | 1212551 | 10 |

| Accessories | | | |
|---------------------|--|---------|-----|
| PSBJ-URTK 6 FARBLOS | | 3026450 | 10 |
| PSBJ-URTK 6 RD | | 3026719 | 10 |
| PSBJ-URTK 6 BU | | 3026434 | 10 |
| PSBJ-URTK 6 YE | | 3026405 | 10 |
| PSBJ-URTK 6 GN | | 3026418 | 10 |
| PSBJ-URTK 6 VT | | 3026421 | 10 |
| PSBJ-URTK 6 BK | | 3026447 | 10 |
| PSBJ-URTK 6 GY | | 3026612 | 10 |
| PSBJ-URTK 6 BN | | 3026971 | 10 |
| C-FCI 1,5/M3 | | 3240032 | 100 |
| C-FCI 2,5/M3 | | 3240037 | 100 |
| C-RCI 1,5/M3 | | 3240016 | 100 |
| C-RCI 2,5/M3 | | 3240021 | 100 |

| Accessories | | | |
|-------------|--|--|--|
|-------------|--|--|--|

UC-TM 8, UCT-TM 8, ZB 8 or TMT (EX9,5)R (see Catalog 5)

UC-TM 8, UCT-TM 8, ZB 8 or TMT (EX9,5)R (see Catalog 5)

UC-TM 8, UCT-TM 8, ZB 8 or TMT (EX9,5)R (see Catalog 5)

Modular terminal blocks

Modular terminal blocks - CLIPLINE complete

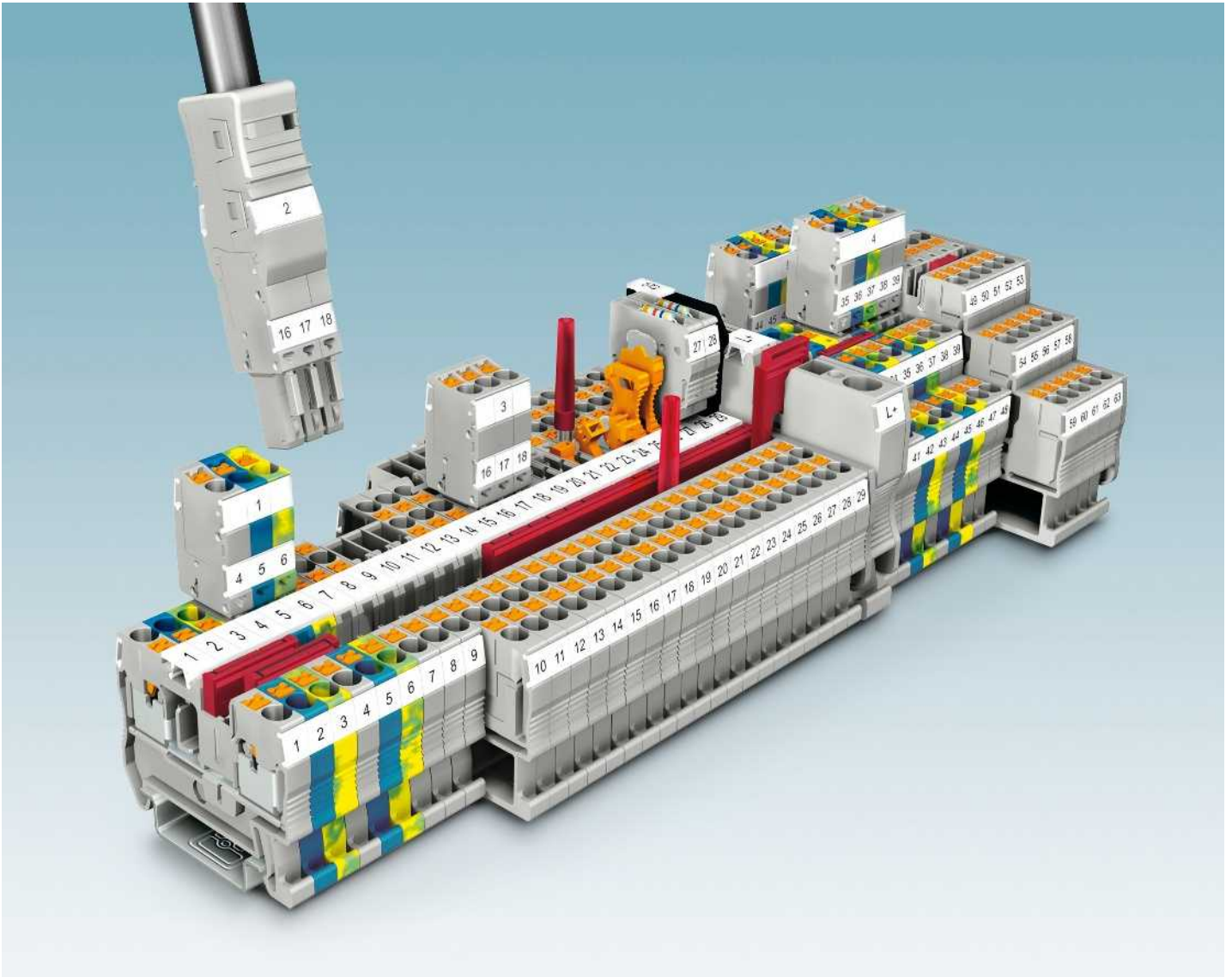

Push-in connection technology

The PT series is characterized by the easy, direct conductor connection and makes consistent use of the benefits of the CLIPLINE complete system.



Easy insertion

The up to 50 percent reduction in insertion force offered by push-in technology supports simple and direct insertion of solid and stranded conductors featuring ferrules with a cross section of 0.34 mm² or higher.



Latch function

The integrated latch allows you to release connections with any type of tool – easily and without direct contact with live parts.

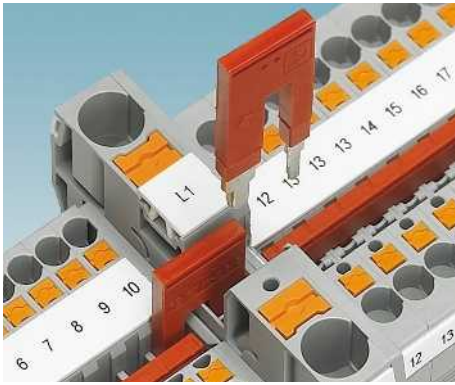

The reducing bridge allows terminal blocks with different nominal cross sections to be connected with ease, e.g., a PT 10 push-in terminal block to a PT 2.5. Power blocks can be created quickly using the reducing bridge.

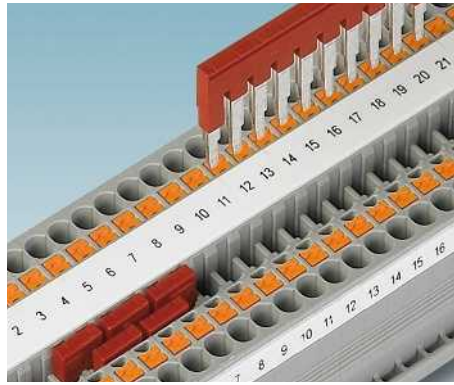

The double function shaft can be used to connect any number of terminal blocks with two-position bridges. The 2 to 50-pos. bridges allow up to 50 terminal blocks to be bridged in one step.

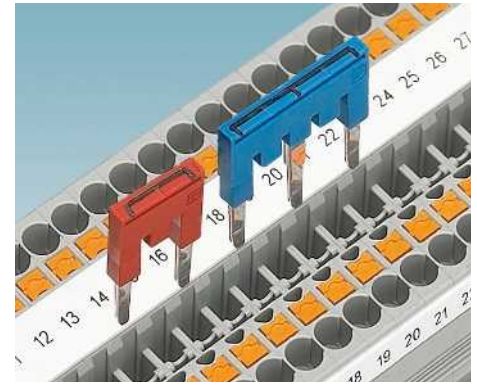

Bridging between non-adjacent terminal blocks is created by removing individual contact tabs from the standard bridge. Two potentials can then be routed in parallel through a terminal strip. The contact points can also be marked.

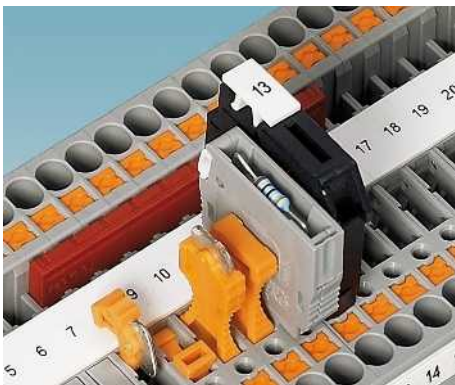

The isolated feed-through connector P-FIX, isolating plug P-DI, component plug P-CO, and the cartridge fuse plug P-FU can be used in the universal plug-in zone of the disconnect terminal block.

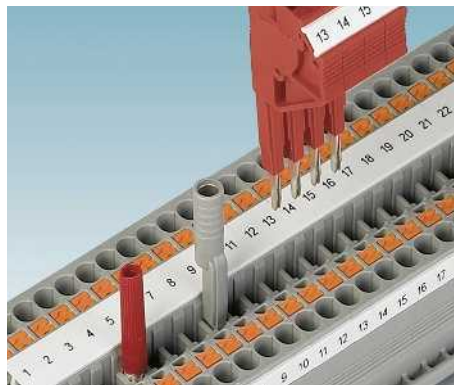

A test plug with a 2.3 mm diameter is available for measuring lines. All measurement and test work can be completed at speed using test adapters for 4 mm diameter test plugs and the modular test plugs.

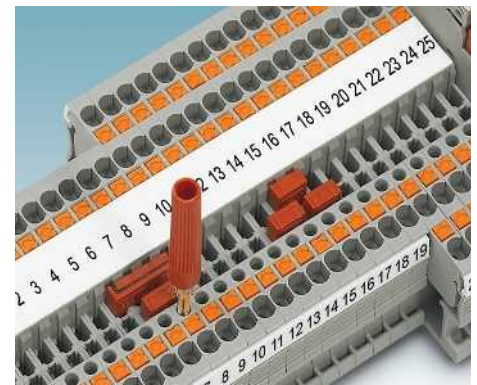

As well as offering a testing facility in the double function shaft, all push-in technology terminal blocks offer an additional test contact for test plugs with a 2.3 mm diameter.

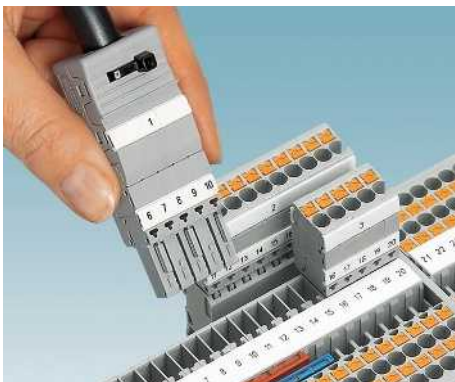

Push-in COMBI terminal blocks are available for the plug-in configuration of signal wiring. The system is touch-proof and offers plugs for self-assembly with extensive accessories.



Automatic flat-type fuse terminal blocks with a 4 mm² conductor connection are available in the same shape as the feed-through terminal blocks. All terminal blocks can be continuously bridged with one another with the double function shaft.



The compact lever-type fuse terminal blocks are of the same shape as the feed-through terminal blocks and can be labeled and bridged continuously. A time-saving potential distribution is easily created using bridging between non-adjacent terminal blocks.

Modular terminal blocks

Modular terminal blocks - CLIPLINE complete

PT 1,5/S... and PTT 1,5/S... push-in knife disconnect terminal blocks



- Now available for the first time with a design width of just 3.5 mm
- Testing facility on both sides of the disconnect point
- Actuation cross on the disconnect knife enables the use of different sized screwdrivers, see image below
- Same shape feed-through versions
- Clear grouping of the terminal strips through orange cover with a design width of just 0.8 mm

Single-level PT 1,5/S...

- Three and four-conductor terminal blocks can be used for multi-conductor connections
- Seamless and can be double bridged for all tasks in time-saving potential supply and distribution

Double-level PTT 1,5/S-2MT

- Space-saving design for maximum wiring density
- Disconnect option on each level
- The assignment from the disconnect knife to the contact points is indicated by the colored levers and the height offset



| Notes: |
|---|
| The nominal current for PT ...MTD... terminal blocks is 17.5 A. |
| 1) The max. load current must not be exceeded by the total current of all connected conductors. |
| 2) Refer to the reducing bridge table; see Catalog 3. |

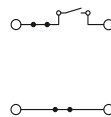

1.5 (1.5) mm², 10 A, knife disconnect terminal block, two connections, bridgeable

| Dimensions | |
|---|--------------------------|
| | [mm] |
| Max. electrical data | |
| | |
| Rated data | |
| Rated voltage | [V] |
| Nominal current / cross section | [A] / [mm ²] |
| Rated cross section | [mm ²] |
| Cross section range | AWG |
| Connection capacity | |
| 1 conductor | [mm ²] |
| Two stranded conductors with a TWIN ferrule | [mm ²] |
| Connection cross sections directly plug-in | [mm ²] |
| General data | |
| Stripping length | [mm] |
| Insulating material | |
| Inflammability class according to UL 94 | |

| Technical data | | | |
|----------------------|----------------------|-------------------------------------|----------------|
| Width | Length | Height NS 35/7,5 | |
| 3.5 | 58.9 | 32 | |
| I _{max} [A] | U _{max} [V] | max. Ø [mm ²] | AWG |
| 10 | 400 | 0.14 - 1.5 | 26 - 14 |
| IEC 60947-7-1 | | | |
| IEC | UL/CUL | CSA | IEC/EN 60079-7 |
| 400 | - | - | - |
| 10/1.5 | - | - | - |
| 1.5 | - | - | - |
| 26 - 14 | - | - | - |
| Connection capacity | | Ferrule with/without plastic sleeve | |
| solid | stranded | | |
| 0.14 - 1.5 | 0.14 - 1.5 | 0.14 - 1.5 | 0.14 - 1 |
| 0.25 - 1.5 | - | 0.34 - 1.5 | 0.34 - 1 |
| General data | | | |
| Stripping length | [mm] | | |
| 8 | | | |
| PA | | | |
| V0 | | | |

| Description | No. of pos. | Color |
|--|-------------|-------|
| Double-level knife disconnect terminal block, disconnection on both levels, for mounting on NS 35... | | gray |
| | | blue |
| Double-level knife disconnect terminal block, disconnection on the upper level, for mounting on NS 35... | | gray |
| | | blue |
| Knife disconnect terminal block, for mounting on NS 35... | | gray |
| | | blue |
| Feed-through terminal block, same shape, for mounting on NS 35... | | gray |
| | | blue |

| Ordering data | | |
|-----------------|-----------|-------------|
| Type | Order No. | Pcs. / Pkt. |
| PT 1,5/S-MT | 3210301 | 50 |
| PT 1,5/S-MT BU | 3210302 | 50 |
| PT 1,5/S-MTD | 3210308 | 50 |
| PT 1,5/S-MTD BU | 3210309 | 50 |

| Cover, 0.8 mm width | | gray |
|---------------------------------------|----|--------|
| | | orange |
| Jumper | | |
| | 2 | red |
| | 3 | red |
| | 4 | red |
| | 5 | red |
| | 10 | red |
| | 20 | red |
| Reducing bridge ²⁾ | | |
| | 2 | red |
| | 2 | red |
| Partition plate, 2 mm width | | gray |
| Test plug metal part, 2.3 mm Ø | | silver |
| Insulating sleeve, for MPS metal part | | red |
| Screwdriver | | |

| Accessories | | |
|----------------------|---------|----|
| D-PT 1,5/S-MT-0,8 | 3210303 | 50 |
| D-PT 1,5/S-MT-0,8 OG | 3210304 | 50 |
| FBS 2-3,5 | 3213014 | 50 |
| FBS 3-3,5 | 3213027 | 50 |
| FBS 4-3,5 | 3213030 | 50 |
| FBS 5-3,5 | 3213043 | 50 |
| FBS 10-3,5 | 3213056 | 50 |
| FBS 20-3,5 | 3213069 | 50 |
| RB ST (2,5/4)-1,5/S | 3214356 | 10 |
| RB ST 6-1,5/S | 3213250 | 10 |
| ATP-ST-TWIN | 3030789 | 50 |
| MPS-MT | 0201744 | 10 |
| MPS-IH RD | 0201676 | 10 |
| SZF 0-0,4X2,5 | 1204504 | 10 |

| |
|---------------------------------|
| Center groove labeling |
| Center and side groove labeling |

| |
|--|
| UCT-TM 3,5 or ZB 3,5 (see Catalog 5) |
| UCT-TMF 3,5 or ZBF 3,5 (see Catalog 5) |

Modular terminal blocks - CLIPLINE complete

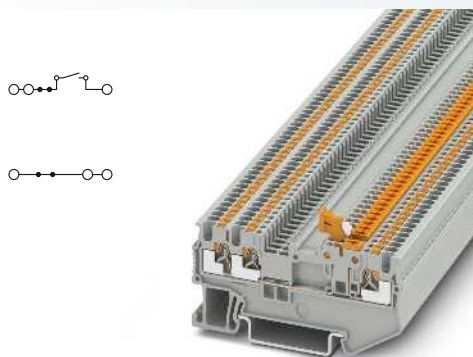

1.5 (1.5) mm², 10 A, knife disconnect terminal block, three connections, bridgeable

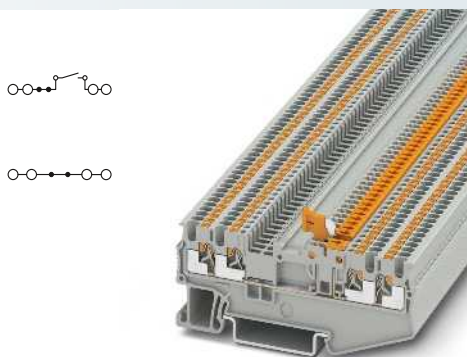

1.5 (1.5) mm², 10 A, knife disconnect terminal block, four connections, bridgeable

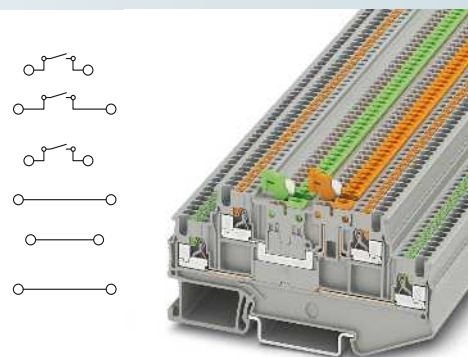

1.5 (1.5) mm², 8 A, double-level knife disconnect terminal block, four connections, not bridgeable

| Technical data | | | |
|-----------------------|---------------|-------------------------------------|----------------|
| Width | Length | Height NS 35/7,5 | |
| 3.5 | 67.8 | 32 | |
| I_{max} [A] | U_{max} [V] | max. Ø [mm ²] | AWG |
| 10 ¹⁾ | 400 | 0.14 - 1.5 | 26 - 14 |
| IEC 60947-7-1 | | | |
| IEC | UL/CUL | CSA | IEC/EN 60079-7 |
| 400 | - | - | - |
| 10 ¹⁾ /1.5 | - | - | - |
| 1.5 | - | - | - |
| 26 - 14 | - | - | - |
| solid | stranded | Ferrule with/without plastic sleeve | |
| 0.14 - 1.5 | 0.14 - 1.5 | 0.14 - 1.5 | 0.14 - 1 |
| 0.25 - 1.5 | - | 0.34 - 1.5 | 0.34 - 1 |
| 8 | | | |
| PA | | | |
| V0 | | | |

| Technical data | | | |
|-----------------------|---------------|-------------------------------------|----------------|
| Width | Length | Height NS 35/7,5 | |
| 3.5 | 76.9 | 32 | |
| I_{max} [A] | U_{max} [V] | max. Ø [mm ²] | AWG |
| 10 ¹⁾ | 400 | 0.14 - 1.5 | 26 - 16 |
| IEC 60947-7-1 | | | |
| IEC | UL/CUL | CSA | IEC/EN 60079-7 |
| 400 | - | - | - |
| 10 ¹⁾ /1.5 | - | - | - |
| 1.5 | - | - | - |
| 26 - 16 | - | - | - |
| solid | stranded | Ferrule with/without plastic sleeve | |
| 0.14 - 1.5 | 0.14 - 1.5 | 0.14 - 1.5 | 0.14 - 1 |
| 0.25 - 1.5 | - | 0.34 - 1.5 | 0.34 - 1 |
| 8 | | | |
| PA | | | |
| V0 | | | |

| Technical data | | | |
|----------------|---------------|-------------------------------------|----------------|
| Width | Length | Height NS 35/7,5 | |
| 3.5 | 86 | 42.6 | |
| I_{max} [A] | U_{max} [V] | max. Ø [mm ²] | AWG |
| 8 | 400 | 0.14 - 1.5 | 26 - 14 |
| IEC 60947-7-1 | | | |
| IEC | UL/CUL | CSA | IEC/EN 60079-7 |
| 400 | - | - | - |
| 8/1.5 | - | - | - |
| 1.5 | - | - | - |
| 26 - 14 | - | - | - |
| solid | stranded | Ferrule with/without plastic sleeve | |
| 0.14 - 1.5 | 0.14 - 1.5 | 0.14 - 1.5 | 0.14 - 1 |
| 0.25 - 1.5 | - | 0.34 - 1.5 | 0.34 - 1 |
| 8 | | | |
| PA | | | |
| V0 | | | |

| Ordering data | | |
|----------------------|-----------|-------------|
| Type | Order No. | Pcs. / Pkt. |
| PT 1,5/S-TWIN-MT | 3210311 | 50 |
| PT 1,5/S-TWIN-MT BU | 3210312 | 50 |
| PT 1,5/S-TWIN-MTD | 3210317 | 50 |
| PT 1,5/S-TWIN-MTD BU | 3210319 | 50 |

| Ordering data | | |
|-------------------------|-----------|-------------|
| Type | Order No. | Pcs. / Pkt. |
| PT 1,5/S-QUATTRO-MT | 3210321 | 50 |
| PT 1,5/S-QUATTRO-MT BU | 3210322 | 50 |
| PT 1,5/S-QUATTRO-MTD | 3210328 | 50 |
| PT 1,5/S-QUATTRO-MTD BU | 3210329 | 50 |

| Ordering data | | |
|-------------------|-----------|-------------|
| Type | Order No. | Pcs. / Pkt. |
| PTT 1,5/S-2MT | 3210351 | 50 |
| PTT 1,5/S-2MT BU | 3210352 | 50 |
| PTT 1,5/S-L/MT | 3210341 | 50 |
| PTT 1,5/S-L/MT BU | 3210342 | 50 |
| PTT 1,5/S-2L | 3210356 | 50 |
| PTT 1,5/S-2L BU | 3210357 | 50 |

| Accessories | | |
|---------------------------|---------|----|
| D-PT 1,5/S-TWIN-MT-0,8 | 3210313 | 50 |
| D-PT 1,5/S-TWIN-MT-0,8 OG | 3210314 | 50 |
| FBS 2-3,5 | 3213014 | 50 |
| FBS 3-3,5 | 3213027 | 50 |
| FBS 4-3,5 | 3213030 | 50 |
| FBS 5-3,5 | 3213043 | 50 |
| FBS 10-3,5 | 3213056 | 50 |
| FBS 20-3,5 | 3213069 | 50 |
| RB ST (2,5/4)-1,5/S | 3214356 | 10 |
| RB ST 6-1,5/S | 3213250 | 10 |
| ATP-ST-TWIN | 3030789 | 50 |
| MPS-MT | 0201744 | 10 |
| MPS-IH RD | 0201676 | 10 |
| SZF 0-0,4X2,5 | 1204504 | 10 |

| Accessories | | |
|------------------------------|---------|----|
| D-PT 1,5/S-QUATTRO-MT-0,8 | 3210333 | 50 |
| D-PT 1,5/S-QUATTRO-MT-0,8 OG | 3210334 | 50 |
| FBS 2-3,5 | 3213014 | 50 |
| FBS 3-3,5 | 3213027 | 50 |
| FBS 4-3,5 | 3213030 | 50 |
| FBS 5-3,5 | 3213043 | 50 |
| FBS 10-3,5 | 3213056 | 50 |
| FBS 20-3,5 | 3213069 | 50 |
| RB ST (2,5/4)-1,5/S | 3214356 | 10 |
| RB ST 6-1,5/S | 3213250 | 10 |
| ATP-ST QUATTRO | 3030815 | 50 |
| MPS-MT | 0201744 | 10 |
| MPS-IH RD | 0201676 | 10 |
| SZF 0-0,4X2,5 | 1204504 | 10 |

| Accessories | | |
|------------------------|---------|----|
| D-PTT 1,5/S-2MT-0,8 | 3210353 | 50 |
| D-PTT 1,5/S-2MT-0,8 OG | 3210354 | 50 |
| ATP-STTB 4 | 3030747 | 50 |
| MPS-MT | 0201744 | 10 |
| MPS-IH RD | 0201676 | 10 |
| SZF 0-0,4X2,5 | 1204504 | 10 |

UCT-TM 3,5 or ZB 3,5
(see Catalog 5)
UCT-TMF 3,5 or ZBF 3,5
(see Catalog 5)

UCT-TM 3,5 or ZB 3,5
(see Catalog 5)
UCT-TMF 3,5 or ZBF 3,5
(see Catalog 5)

UCT-TMF 3,5 or ZBF 3,5
(see Catalog 5)

Modular terminal blocks

Modular terminal blocks - CLIPLINE complete

PTT 2,5... push-in double-level disconnect and knife disconnect terminal blocks

- Design width of just 5.2 mm
- Testing facility on both sides of the disconnect point
- Space-saving design for maximum wiring density
- Clear grouping of the terminal strips through orange cover with a design width of just 0.8 mm
- Disconnection option on each level
- The assignment from the disconnect knife to the contact points is indicated by the colored levers and the height offset

| Notes: |
|---|
| 1) If the fuse is faulty, the downstream circuit is not disconnected. |
| 2) Observe max. load current. |
| 3) Observe max. load current, depending on the power dissipation of the components. Max. 0.5 W with single arrangement. |
| 4) see Catalog 3. |

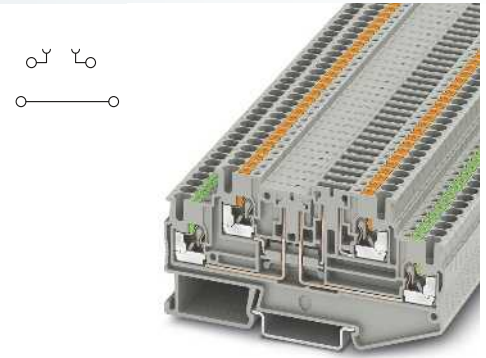

2.5 (4) mm², 16 A, double-level terminal block, with one disconnect zone

| Dimensions | |
|---|--------------------------|
| | [mm] |
| Max. electrical data | |
| | |
| Rated data | |
| Rated voltage | [V] |
| Nominal current / cross section | [A] / [mm ²] |
| Rated cross section | [mm ²] |
| Cross section range | AWG |
| Connection capacity | |
| 1 conductor | [mm ²] |
| Two stranded conductors with a TWIN ferrule | [mm ²] |
| Connection cross sections directly plug-in | [mm ²] |
| General data | |
| Stripping length | [mm] |
| Insulating material | |
| Inflammability class according to UL 94 | |

| Technical data | | | | |
|---|----------------------|---------------------------|----------------|-------------------------------------|
| Width | Length | Height NS 35/7,5 | | |
| 5.2 | 92.4 | 47.4 | | |
| I _{max} [A] | U _{max} [V] | max. Ø [mm ²] | AWG | |
| 16 | 400 | 0.14 - 4 | 26 - 12 | |
| IEC 60947-7-1 | | | | |
| IEC | UL/CUL | CSA | IEC/EN 60079-7 | |
| Rated voltage | 400 | - | - | - |
| Nominal current / cross section | 16/2.5 | - | - | - |
| Rated cross section | 2.5 | - | - | - |
| Cross section range | 26 - 12 | - | - | - |
| Connection capacity | | solid | stranded | Ferrule with/without plastic sleeve |
| 1 conductor | 0.14 - 4 | 0.14 - 2.5 | 0.14 - 2.5 | 0.14 - 2.5 |
| Two stranded conductors with a TWIN ferrule | 0.34 - 4 | - | 0.34 - 2.5 | 0.5 |
| Connection cross sections directly plug-in | 0.34 - 4 | - | 0.34 - 2.5 | 0.34 - 2.5 |
| General data | | 10 | PA | V0 |
| Stripping length | | | | |
| Insulating material | | | | |
| Inflammability class according to UL 94 | | | | |

| Description | Color |
|--|-------|
| Disconnect terminal block , for mounting on NS 35... | gray |
| Knife disconnect terminal block , for mounting on NS 35... | blue |
| Double-level knife disconnect terminal block , disconnection on both levels, for mounting on NS 35... | gray |
| Feed-through terminal block , same shape, for mounting on NS 35... | blue |
| | gray |
| | blue |

| Ordering data | | |
|-----------------|-----------|-------------|
| Type | Order No. | Pcs. / Pkt. |
| PTT 2,5-L/TG | 3210230 | 50 |
| PTT 2,5-L/TG BU | 3210270 | 50 |

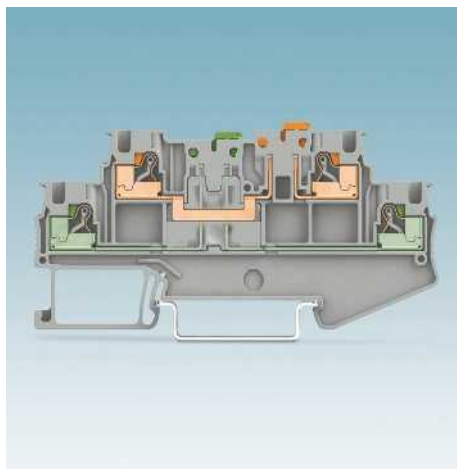

| | |
|--|--------|
| Cover , 0.8 mm width | gray |
| | orange |
| Partition plate , 2 mm width | gray |
| Switching lock , plug-in ⁴⁾ | white |
| Isolating plug²⁾ | orange |
| Feed-through connector²⁾ | gray |
| Component plug , labeled with ZBF 5 or UC-TMF 5 ³⁾ | gray |
| Fuse plug , width 5.2 mm ¹⁾ | black |
| with LED for 12-30 V DC, 0.35-0.95 mA | black |
| for 30-60 V AC/DC, 0.36-0.95 mA | black |
| for 110-250 V AC/DC, 0.4-0.95 mA | black |
| Test plug metal part , 2.3 mm Ø | silver |
| Insulating sleeve , for MPS metal part | red |
| Modular test plug housing , for MPS metal part, can be marked with ZB 5 | red |
| Screwdriver | |
| Lateral groove labeling | |

| Accessories | | |
|--|---------|----|
| D-PTT 2,5-2MT-0,8 | 3210300 | 50 |
| D-PTT 2,5-2MT-0,8 OG | 3210299 | 50 |
| ATP-STTB 4 | 3030747 | 50 |
| P-DI | 3036783 | 50 |
| P-FIX | 3038956 | 50 |
| P-CO | 3036796 | 10 |
| P-FU 5X20-5 | 3209235 | 10 |
| P-FU 5X20 LED 24-5 | 3209248 | 10 |
| P-FU 5X20 LED 60-5 | 3209251 | 10 |
| P-FU 5X20 LED 250-5 | 3209264 | 10 |
| MPS-MT | 0201744 | 10 |
| MPS-IH RD | 0201676 | 10 |
| PS-5/2,3MM RD | 3038723 | 10 |
| SZF 1-0,6X3,5 | 1204517 | 10 |
| UC-TMF 5, UCT-TMF 5 or ZBF 5 (see Catalog 5) | | |

Modular terminal blocks - CLIPLINE complete



2.5 (4) mm², 16 A, double-level terminal block with one knife disconnect zone

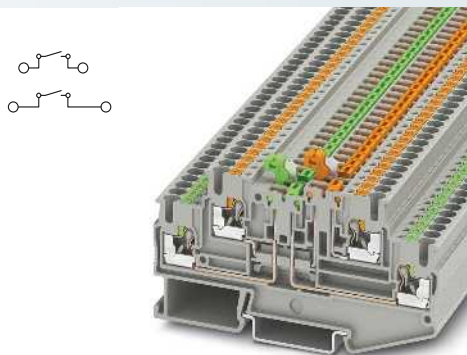

2.5 (4) mm², 16 A, double-level terminal block with two knife disconnect zones

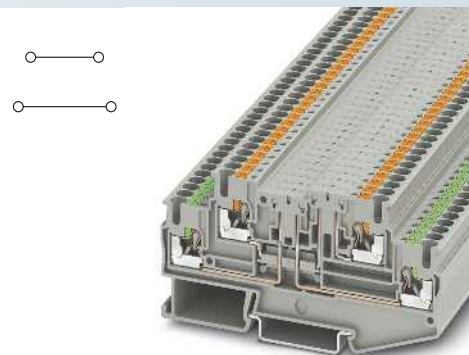

2.5 (4) mm², 20 A, double-level terminal block, same shape

| Technical data | | | |
|----------------|---------------|-------------------------------------|-------------------|
| Width | Length | Height NS 35/7,5 | |
| 5.2 | 92.4 | 47.4 | |
| I_{max} [A] | U_{max} [V] | max. Ø [mm ²] | AWG |
| 16 | 400 | 0.14 - 4 | 26 - 12 |
| IEC 60947-7-1 | | | |
| IEC | UL/CUL | CSA | IEC/EN 60079-7 |
| 400 | - | - | - |
| 16/2.5 | - | - | - |
| 2.5 | - | - | - |
| 26 - 12 | - | - | - |
| solid | stranded | Ferrule with/without plastic sleeve | |
| 0.14 - 4 | 0.14 - 2.5 | 0.14 - 2.5 | 0.14 - 2.5 0.5 |
| 0.34 - 4 | - | 0.34 - 2.5 | 0.34 - 2.5 |
| 10 | PA | V0 | |

| Technical data | | | |
|----------------|---------------|-------------------------------------|-------------------|
| Width | Length | Height NS 35/7,5 | |
| 5.2 | 92.4 | 47.4 | |
| I_{max} [A] | U_{max} [V] | max. Ø [mm ²] | AWG |
| 16 | 400 | 0.14 - 4 | 26 - 12 |
| IEC 60947-7-1 | | | |
| IEC | UL/CUL | CSA | IEC/EN 60079-7 |
| 400 | - | - | - |
| 16/2.5 | - | - | - |
| 2.5 | - | - | - |
| 26 - 12 | - | - | - |
| solid | stranded | Ferrule with/without plastic sleeve | |
| 0.14 - 4 | 0.14 - 2.5 | 0.14 - 2.5 | 0.14 - 2.5 0.5 |
| 0.34 - 4 | - | 0.34 - 2.5 | 0.34 - 2.5 |
| 10 | PA | V0 | |

| Technical data | | | |
|----------------|---------------|-------------------------------------|-------------------|
| Width | Length | Height NS 35/7,5 | |
| 5.2 | 92.4 | 47.4 | |
| I_{max} [A] | U_{max} [V] | max. Ø [mm ²] | AWG |
| 20 | 400 | 0.14 - 4 | 26 - 12 |
| IEC 60947-7-1 | | | |
| IEC | UL/CUL | CSA | IEC/EN 60079-7 |
| 400 | - | - | - |
| 20/2.5 | - | - | - |
| 2.5 | - | - | - |
| 26 - 12 | - | - | - |
| solid | stranded | Ferrule with/without plastic sleeve | |
| 0.14 - 4 | 0.14 - 2.5 | 0.14 - 2.5 | 0.14 - 2.5 0.5 |
| 0.34 - 4 | - | 0.34 - 2.5 | 0.34 - 2.5 |
| 10 | PA | V0 | |

| Ordering data | | |
|-----------------|-----------|-------------|
| Type | Order No. | Pcs. / Pkt. |
| PTT 2,5-L/MT | 3210251 | 50 |
| PTT 2,5-L/MT BU | 3210257 | 50 |

| Ordering data | | |
|----------------|-----------|-------------|
| Type | Order No. | Pcs. / Pkt. |
| PTT 2,5-2MT | 3210258 | 50 |
| PTT 2,5-2MT BU | 3210265 | 50 |

| Ordering data | | |
|---------------|-----------|-------------|
| Type | Order No. | Pcs. / Pkt. |
| PTT 2,5-2L | 3210267 | 50 |
| PTT 2,5-2L BU | 3210268 | 50 |

| Accessories | | |
|----------------------|---------|----|
| D-PTT 2,5-2MT-0,8 | 3210300 | 50 |
| D-PTT 2,5-2MT-0,8 OG | 3210299 | 50 |
| ATP-STTB 4 | 3030747 | 50 |
| S-MT | 3247954 | 50 |
| MPS-MT | 0201744 | 10 |
| MPS-IH RD | 0201676 | 10 |
| PS-5/2,3MM RD | 3038723 | 10 |
| SZF 1-0,6X3,5 | 1204517 | 10 |

| Accessories | | |
|----------------------|---------|----|
| D-PTT 2,5-2MT-0,8 | 3210300 | 50 |
| D-PTT 2,5-2MT-0,8 OG | 3210299 | 50 |
| ATP-STTB 4 | 3030747 | 50 |
| S-MT | 3247954 | 50 |
| MPS-MT | 0201744 | 10 |
| MPS-IH RD | 0201676 | 10 |
| PS-5/2,3MM RD | 3038723 | 10 |
| SZF 1-0,6X3,5 | 1204517 | 10 |

| Accessories | | |
|----------------------|---------|----|
| D-PTT 2,5-2MT-0,8 | 3210300 | 50 |
| D-PTT 2,5-2MT-0,8 OG | 3210299 | 50 |
| ATP-STTB 4 | 3030747 | 50 |
| MPS-MT | 0201744 | 10 |
| MPS-IH RD | 0201676 | 10 |
| PS-5/2,3MM RD | 3038723 | 10 |
| SZF 1-0,6X3,5 | 1204517 | 10 |

UC-TMF 5, UCT-TMF 5 or ZBF 5
(see Catalog 5)

UC-TMF 5, UCT-TMF 5 or ZBF 5
(see Catalog 5)

UC-TMF 5, UCT-TMF 5 or ZBF 5
(see Catalog 5)

Modular terminal blocks

Modular terminal blocks - CLIPLINE complete

PTTBS 2,5... push-in double-level disconnect and knife disconnect terminal blocks in desk design

The angled push-in terminal blocks in desk-design were developed for wiring systems where space is saved by means of underfloor wiring. They offer numerous advantages:

- Design width of just 5.2 mm
- Angled conductor entry for use in flat terminal boxes
- Disconnection option on each level
- The assignment from the disconnect knife to the contact points is indicated by the colored levers and the height offset
- Two function shafts before and after the disconnect point for flexible potential distribution
- Additional 2.3 mm test connections on the contact chamber lever
- Two large-surface, central marking options, marking assigned through a height offset
- Convenient potential bridging of the levels with the vertical FBS-PV potential bridge
- PTTBS 2,5-2TGB with universal disconnect zone, for accommodating isolating plugs, feed-through connectors, component and fuse plugs

CLIP PROJECT Planning enables the quick and convenient planning and configuration of fault-free terminal strips.

| Notes: |
|---|
| 1) If the fuse is faulty, the downstream circuit is not disconnected. |
| 2) Observe max. load current. |
| 3) Observe max. load current, depending on the power dissipation of the components. Max. 0.5 W with single arrangement. |
| 4) see Catalog 3. |

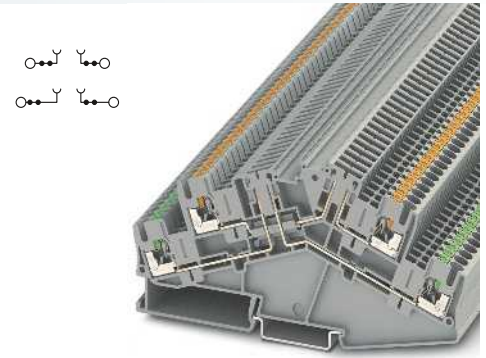

2.5 (4) mm², 16 A, double-level terminal block with two disconnect zones

| Dimensions | |
|---|--------------------------|
| | [mm] |
| Max. electrical data | |
| | |
| Rated data | |
| Rated voltage | [V] |
| Nominal current / cross section | [A] / [mm ²] |
| Rated cross section | [mm ²] |
| Cross section range | AWG |
| Connection capacity | |
| 1 conductor | [mm ²] |
| Two stranded conductors with a TWIN ferrule | [mm ²] |
| Connection cross sections, plug-in | [mm ²] |
| General data | |
| Stripping length | [mm] |
| Insulating material | |
| Inflammability class according to UL 94 | |

| Technical data | | | | |
|---|----------------------|---------------------------|----------------|-------------------------------------|
| Width | Length | Height NS 35/7,5 | | |
| 5.2 | 124.8 | 64.3 | | |
| I _{max} [A] | U _{max} [V] | max. Ø [mm ²] | AWG | |
| 16 | 400 | 0.14 - 4 | 26 - 12 | |
| IEC 60947-7-1 | | | | |
| IEC | UL/CUL | CSA | IEC/EN 60079-7 | |
| Rated voltage | 400 | - | - | - |
| Nominal current / cross section | 16/2.5 | - | - | - |
| Rated cross section | 2.5 | - | - | - |
| Cross section range | 26 - 12 | - | - | - |
| Connection capacity | | solid | stranded | Ferrule with/without plastic sleeve |
| 1 conductor | 0.14 - 4 | 0.14 - 2.5 | 0.14 - 2.5 | 0.14 - 2.5 |
| Two stranded conductors with a TWIN ferrule | 0.34 - 4 | - | 0.34 - 2.5 | 0.5 |
| Connection cross sections, plug-in | 0.34 - 4 | - | 0.34 - 2.5 | 0.34 - 2.5 |
| General data | | | | |
| Stripping length | 10 | | | |
| Insulating material | PA | | | |
| Inflammability class according to UL 94 | V0 | | | |

| Description | No. of pos. | Color |
|---|-------------|-------|
| Disconnect terminal block, for mounting on NS 35... | | gray |
| Knife disconnect terminal block, for mounting on NS 35... | | gray |
| | | blue |

| Ordering data | | |
|----------------|-----------|-------------|
| Type | Order No. | Pcs. / Pkt. |
| PTTBS 2,5-2TGB | 3210402 | 50 |

| | |
|---|--------|
| Cover, 0.8 mm width | gray |
| Insulation stop sleeve, cross section range: | |
| 0.08 - 0.2 mm ² | white |
| 0.25 - 0.5 mm ² | gray |
| 0.75 - 1 mm ² | black |
| Jumper | |
| | 2 red |
| | 3 red |
| | 4 red |
| | 5 red |
| | 10 red |
| | 20 red |
| Vertical potential bridge, to connect the upper and lower level | black |

| Accessories | | |
|---------------------|---------|----|
| D-PTTBS 2,5-2MTB | 3210404 | 50 |
| ISH 2,5/0,2 | 3002843 | 50 |
| ISH 2,5/0,5 | 3002856 | 50 |
| ISH 2,5/1,0 | 3002869 | 50 |
| FBS 2-5 | 3030161 | 50 |
| FBS 3-5 | 3030174 | 50 |
| FBS 4-5 | 3030187 | 50 |
| FBS 5-5 | 3030190 | 50 |
| FBS 10-5 | 3030213 | 10 |
| FBS 20-5 | 3030226 | 10 |
| FBS-PV | 3032185 | 50 |
| PS-5 | 3030983 | 10 |
| P-DI | 3036783 | 50 |
| P-FIX | 3038956 | 50 |
| P-CO | 3036796 | 10 |
| P-FU 5X20-5 | 3209235 | 10 |
| P-FU 5X20 LED 24-5 | 3209248 | 10 |
| P-FU 5X20 LED 60-5 | 3209251 | 10 |
| P-FU 5X20 LED 250-5 | 3209264 | 10 |
| SZF 1-0,6X3,5 | 1204517 | 10 |

| | |
|---|--------|
| Switching lock, plug-in ⁴⁾ | white |
| Modular test plug, for the individual assembly of test pin strips | red |
| Isolating plug ²⁾ | orange |
| Feed-through connector ²⁾ | gray |
| Component plug, labeled with ZBF 5 or UC-TMF 5 ³⁾ | gray |
| Fuse plug, width 5.2 mm ¹⁾ | black |
| With LED for 12-30 V DC, 0.35-0.95 mA | black |
| for 30-60 V AC/DC, 0.36-0.95 mA | black |
| for 110-250 V AC/DC, 0.4-0.95 mA | black |
| Screwdriver | |

| | |
|------------------------|---|
| Center groove labeling | UC-TM 5, UCT-TM 5 or ZB 5 (see Catalog 5) |
|------------------------|---|

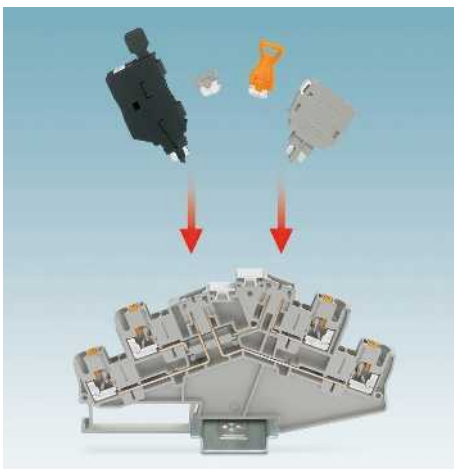

Modular terminal blocks

Modular terminal blocks - CLIPLINE complete

UT ...-TG screw connection, disconnect and knife disconnect terminal blocks with fuse plug



- Compact design and high current carrying capacity of up to 20 A
- Double bridge shaft enables individual potential distribution and supply
- The function terminals are suitable for use in potentially explosive areas (zone 2) according to standards established worldwide.

They meet the requirements of the following ignition protection concepts:

Marking

IECEX:

- Ex nA IIC Gc
- ATEX:
- II 3 G Ex nA IIC Gc
- Ex i

UL US

- AEx nA IIC Gc
- Class I zone 2
- Class I Division 2 Groups A B

S-MT switching lock

- The optional switching lock snaps in and effectively prevents accidental switching, see figure below



| Notes: |
|--|
| Detailed information and data sheets regarding modular terminal blocks in the Ex area are available in the product area on our website at phoenixcontact.net/products and in IECEx Certificate of Conformity IECEx UL 13.0007U and in UL file E192998. |
| 1) If the fuse is faulty, the downstream circuit is not disconnected. |
| 2) Current and voltage are determined by the plug used. |
| 3) see Catalog 3. |



4 (6) mm², 20 A, disconnect terminal block, with test socket screws

Ex:
IECEX UL 13.0007U

Technical data

| Width | Length | Height NS 35/7,5 | |
|--|-----------------------|---------------------------|-----------------------------|
| 6.2 | 57.8 | 47.5 | |
| I_{max} [A] | U_{max} [V] | max. Ø [mm ²] | AWG |
| 20 ²) | 500 ²) | 0.14 - 6 | 26 - 10 |
| IEC 60947-7-1 | | | |
| IEC | UL/CUL | CSA | IEC/EN 60079-7 |
| Rated voltage [V] | 500 ²) | - | 250 |
| Nominal current / cross section [A] / [mm ²] | 20 ²)/2.5 | - | 6.3 |
| Rated cross section [mm ²] | 4 | - | 0.14-4 |
| Cross section range AWG | 26 - 10 | - | 26 - 10 |
| Connection capacity | | Ferrule | |
| 1 conductor [mm ²] | 0.14 - 6 | 0.14 - 6 | with/without plastic sleeve |
| Two conductors (of the same type) [mm ²] | 0.14 - 1.5 | 0.14 - 1.5 | 0.14 - 4 |
| Two stranded conductors with a TWIN ferrule [mm ²] | | | - |
| | | | 0.5 - 2.5 |
| General data | | | |
| Stripping length [mm] | 9 | | |
| Insulating material | PA | | |
| Inflammability class according to UL 94 | V0 | | |

Ordering data

| Type | Order No. | Pcs. / Pkt. |
|----------------|-----------|-------------|
| UT 4-TG-EX | 3046143 | 50 |
| UT 4-TG-P/P-EX | 3046169 | 50 |

Accessories

| | | |
|--------------|---------|----|
| ATP-UT-TWIN | 3047183 | 50 |
| PAI-4-N GY | 3032871 | 10 |
| MPS-MT | 0201744 | 10 |
| MPS-IH RD | 0201676 | 10 |
| PS-6 | 3030996 | 10 |
| P-FU 5X20-EX | 3036807 | 10 |
| SZS 0,6X3,5 | 1205053 | 10 |

| Dimensions | | [mm] |
|--|-----------------------|------------|
| Max. electrical data | | |
| Rated data | | |
| Rated voltage [V] | 500 ²) | - |
| Nominal current / cross section [A] / [mm ²] | 20 ²)/2.5 | - |
| Rated cross section [mm ²] | 4 | - |
| Cross section range AWG | 26 - 10 | - |
| Connection capacity | | |
| 1 conductor [mm ²] | 0.14 - 6 | 0.14 - 6 |
| Two conductors (of the same type) [mm ²] | 0.14 - 1.5 | 0.14 - 1.5 |
| Two stranded conductors with a TWIN ferrule [mm ²] | | |
| General data | | |
| Stripping length [mm] | 9 | |
| Insulating material | PA | |
| Inflammability class according to UL 94 | V0 | |

| Description | No. of pos. | Color |
|--|-------------|-------|
| Disconnect terminal block, for mounting on NS 35... with test socket screws | | gray |
| Knife disconnect terminal block, for mounting on NS 35... | | gray |
| Fuse plug, width 6.2 mm ¹) with LED for 12-30 V DC, 0.35-0.95 mA | | black |
| for 30-60 V AC/DC, 0.36-0.95 mA | | black |
| for 110-250 V AC/DC, 0.4-0.95 mA | | black |
| Fuse plug, width 8.2 mm ¹) with LED for 12-30 V DC, 0.35-0.95 mA | | black |
| for 30-60 V AC/DC, 0.36-0.95 mA | | black |
| for 110-250 V AC/DC, 0.4-0.95 mA | | black |

| | |
|---|--------|
| Switching lock, plug-in ³) | white |
| Partition plate, 2.2 mm wide | gray |
| Test adapter, 4 mm test socket hole | gray |
| Test plug metal part, 2.3 mm Ø | silver |
| Insulating sleeve, for MPS metal part | red |
| Modular test plug, for the individual assembly of test pin strips | red |
| Fuse plug, width 6.2 mm ¹) | black |
| Width 8.2 mm | black |

| |
|-------------------------|
| Center groove labeling |
| Lateral groove labeling |

UC-TM 6, UCT-TM 6 or ZB 6 (see Catalog 5)

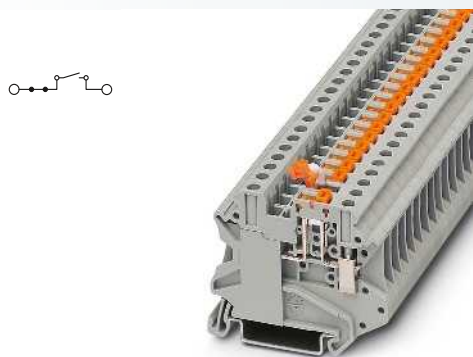

4 (6) mm², 20 A, knife disconnect terminal block, with test socket screws

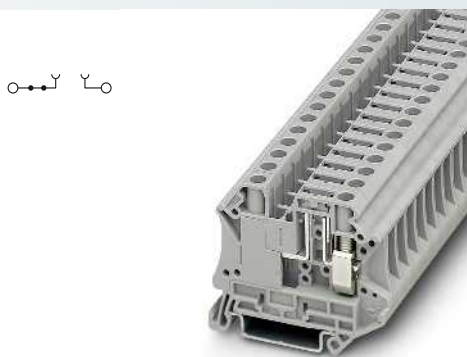

6 (10) mm², 20 A, disconnect terminal block, with test socket screws



6.2 mm and 8.2 mm fuse plug, for 5 x 20 mm and 6.3 x 32 mm cartridge fuses

Ex: IECEx UL 13.0007U

Ex: IECEx UL 13.0007U

Ex: IECEx UL 13.0007U

| Technical data | | | |
|----------------------|----------------------|-------------------------------------|----------------|
| Width | Length | Height NS 35/7,5 | |
| 6.2 | 57.8 | 49.1 | |
| I _{max} [A] | U _{max} [V] | max. Ø [mm ²] | AWG |
| 20 | 500 | 0.14 - 6 | 26 - 10 |
| IEC 60947-7-1 | | | |
| IEC | UL/CUL | CSA | IEC/EN 60079-7 |
| 500 | - | - | 500 |
| 20/2.5 | - | - | 16 |
| 4 | - | - | 0.14-4 |
| 26 - 10 | - | - | 26 - 10 |
| solid | stranded | Ferrule with/without plastic sleeve | |
| 0.14 - 6 | 0.14 - 6 | 0.14 - 4 | 0.14 - 4 |
| 0.14 - 1.5 | 0.14 - 1.5 | 0.14 - 1.5 | - |
| 0.5 - 2.5 | | | |
| 9 | | | |
| PA | | | |
| V0 | | | |

| Technical data | | | |
|-----------------------|----------------------|-------------------------------------|----------------|
| Width | Length | Height NS 35/7,5 | |
| 8.2 | 57.8 | 47.5 | |
| I _{max} [A] | U _{max} [V] | max. Ø [mm ²] | AWG |
| 20 ²⁾ | 500 ²⁾ | 0.2 - 10 | 24 - 8 |
| IEC 60947-7-1 | | | |
| IEC | UL/CUL | CSA | IEC/EN 60079-7 |
| 500 ²⁾ | - | - | 250 |
| 20 ²⁾ /2.5 | - | - | 6.3 |
| 6 | - | - | 0.2-6 |
| 24 - 8 | - | - | 24 - 8 |
| solid | stranded | Ferrule with/without plastic sleeve | |
| 0.2 - 10 | 0.2 - 10 | 0.25 - 6 | 0.25 - 6 |
| 0.2 - 2.5 | 0.2 - 2.5 | 0.25 - 1.5 | - |
| 0.5 - 4 | | | |
| 10 | | | |
| PA | | | |
| V0 | | | |

| Technical data | | | |
|----------------|----------|-------------------------------------|----------------|
| Width | Length | Height NS 35/7,5 | |
| - | - | - | |
| | | max. Ø [mm ²] | AWG |
| | | - | - |
| IEC | UL/CUL | CSA | IEC/EN 60079-7 |
| - | - | - | - |
| - | - | - | - |
| - | - | - | - |
| - | - | - | - |
| solid | stranded | Ferrule with/without plastic sleeve | |
| - | - | - | - |
| - | - | - | - |
| - | | | |
| PA | | | |
| V0 | | | |

| Ordering data | | |
|----------------|-----------|-------------|
| Type | Order No. | Pcs. / Pkt. |
| UT 4-MT-EX | 3046141 | 50 |
| UT 4-MT-P/P-EX | 3046173 | 50 |

| Ordering data | | |
|----------------|-----------|-------------|
| Type | Order No. | Pcs. / Pkt. |
| UT 6-TG-EX | 3046486 | 50 |
| UT 6-TG P/P-EX | 3073870 | 50 |

| Ordering data | | |
|-----------------------|-----------|-------------|
| Type | Order No. | Pcs. / Pkt. |
| P-FU 5X20-EX | 3036807 | 10 |
| P-FU 5X20 LED 24-EX | 3036821 | 10 |
| P-FU 5X20 LED 60-EX | 3036823 | 10 |
| P-FU 5X20 LA 250-EX | 3036836 | 10 |
| P-FU 6,3X32-EX | 3046499 | 10 |
| P-FU 6,3X32 LED 24-EX | 3046509 | 10 |
| P-FU 6,3X32 LED 60-EX | 3046512 | 10 |
| P-FU 6,3X32 LA 250-EX | 3046525 | 10 |

| Accessories | | |
|-------------|---------|----|
| S-MT | 3247954 | 50 |
| ATP-UT-TWIN | 3047183 | 50 |
| PAI-4-N GY | 3032871 | 10 |
| MPS-MT | 0201744 | 10 |
| MPS-IH RD | 0201676 | 10 |
| PS-6 | 3030996 | 10 |
| SZS 0,6X3,5 | 1205053 | 10 |

| Accessories | | |
|-----------------|---------|----|
| ATP-UT-TWIN | 3047183 | 50 |
| PAI-4-N GY | 3032871 | 10 |
| MPS-MT | 0201744 | 10 |
| MPS-IH RD | 0201676 | 10 |
| PS-6 | 3030996 | 10 |
| P-FU 6,3X32-EX | 3046499 | 10 |
| SZS 1,0X4,0 VDE | 1205066 | 10 |

| Accessories | | |
|-------------|--|--|
| | | |
| | | |
| | | |
| | | |

UC-TM 6, UCT-TM 6 or ZB 6 (see Catalog 5)

UC-TM 8, UCT-TM 8 or ZB 8 (see Catalog 5)

UC-TMF 5, UCT-TMF 5 or ZBF 5 (see Catalog 5)

Modular terminal blocks

Modular terminal blocks - CLIPLINE complete

UTTB ...-TG, UTT ...-2(MT) screw connection, double-level disconnect and knife disconnect terminal blocks

- Optimized for process technology through:
- Design width of just 5.2 mm
 - Space-saving design for maximum wiring density
 - Disconnection option on each level
 - Testing facility on both sides of the disconnect point
 - Clear assignment of the disconnect levels thanks to height offset and color disconnect knife, green at the bottom, orange at the top

Offset levels

- Offset levels provide:
- Unobstructed access to the lower connection level if fully wired
 - Better view of the lower marking labels and conductor entry funnel

| Notes: |
|---|
| 1) Observe max. load current. |
| 2) Observe max. load current, depending on the power dissipation of the components. Max. 0.5 W with single arrangement. |
| 3) Current and voltage are determined by the plug used. |
| 4) see Catalog 3. |
| 5) For maximum power dissipation, see Catalog 3. |

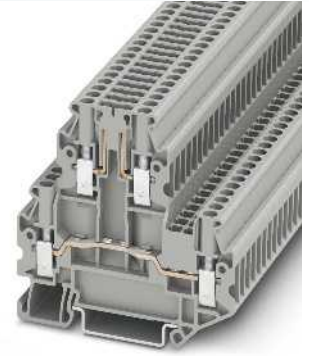
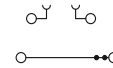

2.5 (4) mm², 20 A, double-level terminal block with disconnect zone, test socket screw

| Dimensions | [mm] |
|--|-------------------------------------|
| Width | 5.2 |
| Length | 69.9 |
| Height NS 35/7,5 | 64.8 |
| Max. electrical data | |
| I _{max.} [A] | 20 |
| U _{max.} [V] | 400 |
| IEC 60947-7-1 | |
| IEC | UL/CUL |
| CSA | IEC/EN 60079-7 |
| Rated data lower level | |
| Rated voltage [V] | 400 |
| Nominal current / cross section [A] / [mm ²] | 20/2.5 |
| Rated cross section [mm ²] | 2.5 |
| Cross section range AWG | 26 - 12 |
| Rated data, upper level | |
| IEC | UL/CUL |
| CSA | IEC/EN 60079-7 |
| Connection capacity | |
| Nominal current / cross section [A] / [mm ²] | 16 ³⁾ /2.5 |
| solid | stranded |
| | Ferrule with/without plastic sleeve |
| 1 conductor [mm ²] | 0.14 - 4 |
| Two conductors (of the same type) [mm ²] | 0.14 - 4 |
| Two stranded conductors with a TWIN ferrule [mm ²] | 0.14 - 1.5 |
| | 0.14 - 2.5 |
| | 0.14 - 1.5 |
| | 0.5 - 1.5 |
| General data | |
| Stripping length [mm] | 9 |
| Screw thread | M3 |
| Tightening torque [Nm] | 0.5 - 0.6 |
| Insulating material | PA |
| Inflammability class according to UL 94 | V0 |

| Technical data | | | |
|--|-----------------------|-------------------------------------|----------------|
| Width | Length | Height NS 35/7,5 | |
| 5.2 | 69.9 | 64.8 | |
| I _{max.} [A] | U _{max.} [V] | max. Ø [mm ²] | AWG |
| 20 | 400 | 0.14 - 4 | 26 - 12 |
| IEC 60947-7-1 | | | |
| IEC | UL/CUL | CSA | IEC/EN 60079-7 |
| Rated voltage [V] | 400 | - | - |
| Nominal current / cross section [A] / [mm ²] | 20/2.5 | - | - |
| Rated cross section [mm ²] | 2.5 | - | - |
| Cross section range AWG | 26 - 12 | - | - |
| IEC | UL/CUL | CSA | IEC/EN 60079-7 |
| Nominal current / cross section [A] / [mm ²] | 16 ³⁾ /2.5 | - | - |
| solid | stranded | Ferrule with/without plastic sleeve | |
| 1 conductor [mm ²] | 0.14 - 4 | 0.14 - 2.5 | 0.14 - 2.5 |
| Two conductors (of the same type) [mm ²] | 0.14 - 1.5 | 0.14 - 1.5 | - |
| Two stranded conductors with a TWIN ferrule [mm ²] | | | 0.5 - 1.5 |
| Stripping length [mm] | 9 | | |
| Screw thread | M3 | | |
| Tightening torque [Nm] | 0.5 - 0.6 | | |
| Insulating material | PA | | |
| Inflammability class according to UL 94 | V0 | | |

| Description | No. of pos. | Color |
|--|-------------|-------|
| Disconnect terminal block, for mounting on NS 35... | | gray |
| Knife disconnect terminal block, for mounting on NS 35... | | gray |
| | | blue |
| Double-level knife disconnect terminal block, disconnection on both levels, for mounting on NS 35... | | gray |
| | | blue |

| Ordering data | | |
|----------------|-----------|-------------|
| Type | Order No. | Pcs. / Pkt. |
| UTT 2,5-TG-P/P | 3044644 | 50 |

| Cover, width 2.2 mm | gray |
|--|--------|
| Spacer plate, compensates for level offsets, width 2.5 mm | gray |
| Jumper | |
| | 2 red |
| | 3 red |
| | 4 red |
| | 5 red |
| | 10 red |
| | 20 red |
| Switching lock, plug-in ⁴⁾ | white |
| Isolating plug ¹⁾ | orange |
| Feed-through connector ¹⁾ | gray |
| Component plug, labeled with ZBF 5 or UC-TMF 5 ²⁾ | gray |
| Fuse plug, width 6.2 mm ⁵⁾ | black |
| Screwdriver | |
| Lateral groove labeling | |

| Accessories | | |
|---|---------|----|
| D-UTT 2,5/4 | 3044676 | 50 |
| DP-UTT 2,5/4 | 3044677 | 50 |
| FBS 2-5 | 3030161 | 50 |
| FBS 3-5 | 3030174 | 50 |
| FBS 4-5 | 3030187 | 50 |
| FBS 5-5 | 3030190 | 50 |
| FBS 10-5 | 3030213 | 10 |
| FBS 20-5 | 3030226 | 10 |
| P-DI | 3036783 | 50 |
| P-FIX | 3038956 | 50 |
| P-CO | 3036796 | 10 |
| P-FU 5X20 | 3036806 | 10 |
| SZG 0,6X3,5 VDE | 1205121 | 10 |
| UC-TM 5, UCT-TM 5 or ZB 5 (see Catalog 5) | | |



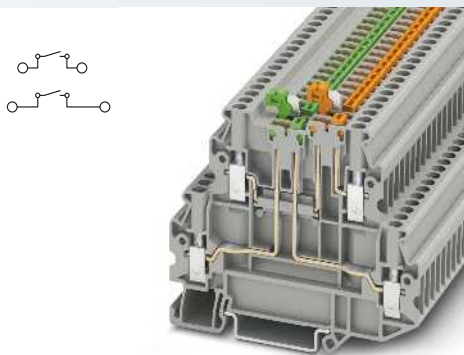
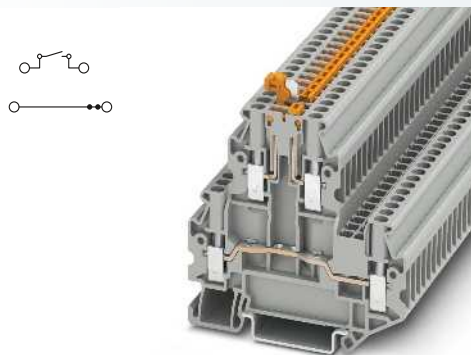

2.5 (4) mm², 20 A, double-level terminal block with disconnect knife, test socket screw

2.5 (4) mm², 16 A, double-level terminal block with a disconnect knife per level, test socket screw

| Technical data | | | |
|----------------------|----------------------|-------------------------------------|----------------|
| Width | Length | Height NS 35/7,5 | |
| 5.2 | 69.9 | 64.8 | |
| I _{max} [A] | U _{max} [V] | max. Ø [mm ²] | AWG |
| 20 | 400 | 0.14 - 4 | 26 - 12 |
| IEC 60947-7-1 | | | |
| IEC | UL/CUL | CSA | IEC/EN 60079-7 |
| 400 | - | - | - |
| 20/2.5 | - | - | - |
| 2.5 | - | - | - |
| 26 - 12 | - | - | - |
| IEC | UL/CUL | CSA | IEC/EN 60079-7 |
| 16/2.5 | - | - | - |
| solid | stranded | Ferrule with/without plastic sleeve | |
| 0.14 - 4 | 0.14 - 4 | 0.14 - 2.5 | 0.14 - 2.5 |
| 0.14 - 1.5 | 0.14 - 1.5 | 0.14 - 1.5 | - |
| | | | 0.5 - 1.5 |

| Technical data | | | |
|----------------------|----------------------|-------------------------------------|----------------|
| Width | Length | Height NS 35/7,5 | |
| 5.2 | 80.1 | 58.1 | |
| I _{max} [A] | U _{max} [V] | max. Ø [mm ²] | AWG |
| 16 | 400 | 0.14 - 4 | 26 - 12 |
| IEC 60947-7-1 | | | |
| IEC | UL/CUL | CSA | IEC/EN 60079-7 |
| 400 | - | - | - |
| 16/2.5 | - | - | - |
| 2.5 | - | - | - |
| 26 - 12 | - | - | - |
| IEC | UL/CUL | CSA | IEC/EN 60079-7 |
| 16/2.5 | - | - | - |
| solid | stranded | Ferrule with/without plastic sleeve | |
| 0.14 - 4 | 0.14 - 4 | 0.14 - 2.5 | 0.14 - 2.5 |
| 0.14 - 1.5 | 0.14 - 1.5 | 0.14 - 1.5 | - |
| | | | 0.5 - 1.5 |

9
M3
0.5 - 0.6
PA
V0

9
M3
0.5 - 0.6
PA
V0

| Ordering data | | |
|-------------------|-----------|-------------|
| Type | Order No. | Pcs. / Pkt. |
| UTT 2,5-MT-P/P | 3044640 | 50 |
| UTT 2,5-MT-P/P BU | 3044641 | 50 |

| Ordering data | | |
|--------------------|-----------|-------------|
| Type | Order No. | Pcs. / Pkt. |
| UTT 2,5-2MT-P/P | 3044670 | 50 |
| UTT 2,5-2MT-P/P BU | 3044671 | 50 |

| Accessories | | |
|-----------------|---------|----|
| D-UTT 2,5/4 | 3044676 | 50 |
| DP-UTT 2,5/4 | 3044677 | 50 |
| FBS 2-5 | 3030161 | 50 |
| FBS 3-5 | 3030174 | 50 |
| FBS 4-5 | 3030187 | 50 |
| FBS 5-5 | 3030190 | 50 |
| FBS 10-5 | 3030213 | 10 |
| FBS 20-5 | 3030226 | 10 |
| S-MT | 3247954 | 50 |
| SZG 0,6X3,5 VDE | 1205121 | 10 |

| Accessories | | |
|-----------------|---------|----|
| D-UTT 2,5/4 | 3044676 | 50 |
| DP-UTT 2,5/4 | 3044677 | 50 |
| S-MT | 3247954 | 50 |
| SZG 0,6X3,5 VDE | 1205121 | 10 |

UC-TM 5, UCT-TM 5 or ZB 5 (see Catalog 5)

UC-TM 5, UCT-TM 5 or ZB 5 (see Catalog 5)

Modular terminal blocks

Modular terminal blocks - CLIPLINE complete

Screw connection, multi-level function and lever-type fuse terminal blocks with UT 4... PE foot

- Suitable for process technology thanks to applied for Ex nA approval
- For power and signal transmission in potentially explosive areas
- Same shape as UT 4-PE/L/HESI multi-level lever-type fuse terminal blocks on the following page

Terminal strip service

We produce fully pre-assembled terminal strips for fitting straight into the control cabinet or switch system. This simplifies installation, saves time, and cuts costs.

| Notes: |
|---|
| 1) Observe max. load current. |
| 2) Observe max. load current, depending on the power dissipation of the components. Max. 0.5 W with single arrangement. |
| 3) Current and voltage are determined by the plug used. |
| 4) see Catalog 3. |
| 5) For maximum power dissipation, see Catalog 3. |

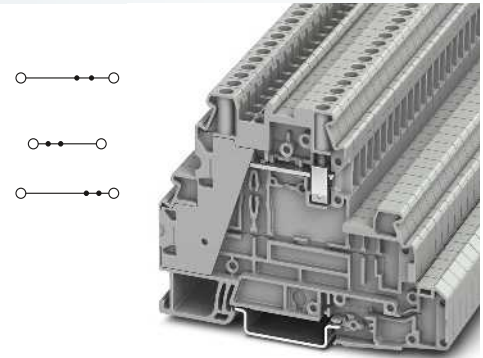

4 (6) mm², 36 A, feed-through terminal block

| Dimensions | [mm] |
|---|--------------------------|
| Max. electrical data | |
| Rated data lower level | |
| Rated voltage | [V] |
| Nominal current / cross section | [A] / [mm ²] |
| Rated cross section | [mm ²] |
| Cross section range | AWG |
| Rated data, upper level | |
| Nominal current / cross section | [A] / [mm ²] |
| Connection capacity | |
| 1 conductor | [mm ²] |
| Two conductors (of the same type) | [mm ²] |
| Two stranded conductors with a TWIN ferrule | [mm ²] |
| General data | |
| Stripping length | [mm] |
| Screw thread | |
| Tightening torque | [Nm] |
| Insulating material | |
| Inflammability class according to UL 94 | |

| Technical data | | | |
|---|----------------------|-------------------------------------|----------------|
| Width | Length | Height NS 35/7,5 | |
| 6.2 | 92.7 | 61.7 | |
| I _{max} [A] | U _{max} [V] | max. Ø [mm ²] | AWG |
| 36 | 500 | 0.14 - 6 | 26 - 10 |
| IEC 60947-7-1 | | | |
| IEC | UL/CUL | CSA | IEC/EN 60079-7 |
| Rated voltage | | | |
| 500 | - | - | - |
| Nominal current / cross section | | | |
| 30/4 | - | - | - |
| Rated cross section | | | |
| 4 | - | - | - |
| Cross section range | | | |
| 26 - 10 | - | - | - |
| Rated data, upper level | | | |
| IEC | UL/CUL | CSA | IEC/EN 60079-7 |
| Nominal current / cross section | | | |
| 32/4 | - | - | - |
| Connection capacity | | | |
| solid | stranded | Ferrule with/without plastic sleeve | |
| 0.14 - 6 | 0.14 - 6 | 0.14 - 4 | 0.14 - 4 |
| 0.14 - 1.5 | 0.14 - 1.5 | 0.14 - 1.5 | - |
| | | | 0.5 - 1.5 |
| Stripping length | | | |
| 9 | | | |
| Screw thread | | | |
| M3 | | | |
| Tightening torque | | | |
| 0.6 - 0.8 | | | |
| Insulating material | | | |
| PA | | | |
| Inflammability class according to UL 94 | | | |
| V0 | | | |

| Description | No. of pos. | Color |
|---|-------------|-------|
| Feed-through terminal block, only in the upper level, for mounting on NS 35... | | gray |
| Multi-level terminal block, upper and middle level, for mounting on NS 35... | | gray |
| Multi-level terminal block, 2 x feed-through, 1 x PE, for mounting on NS 35... | | gray |
| Multi-level terminal block, 1 x feed-through, 1 x blue printed feed-through, 1 x PE, for mounting on NS 35... | | gray |
| Disconnect terminal block, for mounting on NS 35... | | gray |
| Knife disconnect terminal block, for mounting on NS 35... | | gray |

| Ordering data | | | |
|---------------|------------------|-----------|-------------|
| Type | I _{max} | Order No. | Pcs. / Pkt. |
| UT 4-L | | 3214363 | 50 |
| UT 4-L/L | | 3214362 | 50 |

| Jumper | No. of pos. | Color |
|--|-------------|--------|
| | 2 | red |
| | 3 | red |
| | 4 | red |
| | 5 | red |
| | 10 | red |
| | 20 | red |
| Switching lock, plug-in ⁴⁾ | | white |
| Isolating plug ¹⁾ | | orange |
| Feed-through connector ¹⁾ | | gray |
| Component plug, labeled with ZBF 5 or UC-TMF 5 ²⁾ | | gray |
| Fuse plug, width 6.2 mm ⁵⁾ | | black |
| Screwdriver | | |

| Accessories | | | |
|-------------|------|---------|----|
| FBS 2-6 | 28 A | 3030336 | 50 |
| FBS 3-6 | 28 A | 3030242 | 50 |
| FBS 4-6 | 28 A | 3030255 | 50 |
| FBS 5-6 | 28 A | 3030349 | 50 |
| FBS 10-6 | 28 A | 3030271 | 10 |
| FBS 20-6 | 28 A | 3030365 | 10 |
| SZS 0,6X3,5 | | 1205053 | 10 |

| |
|---------------------------------|
| Center and side groove labeling |
| Lateral groove labeling |

| |
|---|
| UC-TM 6, UCT-TM 6 or ZB 6 (see Catalog 5) |
|---|



Modular terminal blocks - CLIPLINE complete

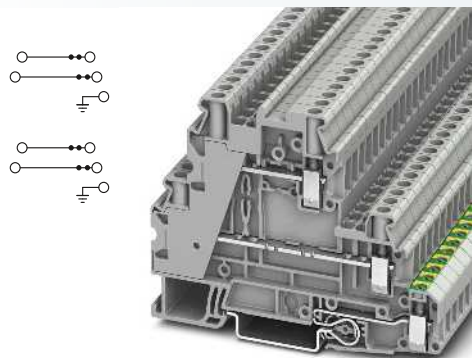

4 (6) mm², 36 A, multi-level terminal block, PE foot

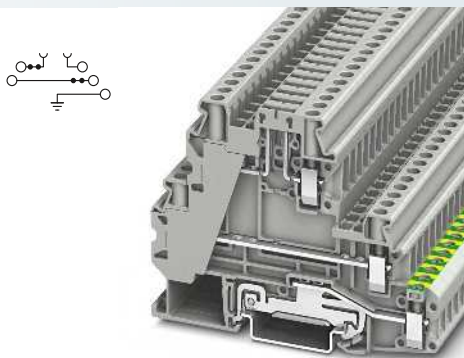

4 (6) mm², 36 A, multi-level terminal block, disconnect zone, PE foot

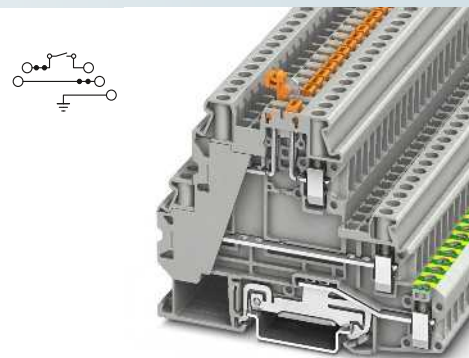

4 (6) mm², 36 A, multi-level terminal block, disconnect knife, PE foot

| Technical data | | | |
|-----------------------------|----------------------|-------------------------------------|----------------|
| Width | Length | Height NS 35/7,5 | |
| 6.2 | 92.7 | 61.7 | |
| I _{max} [A] | U _{max} [V] | max. Ø [mm ²] | AWG |
| 36 | 500 | 0.14 - 6 | 26 - 10 |
| IEC 60947-7-1/IEC 60947-7-2 | | | |
| IEC | UL/CUL | CSA | IEC/EN 60079-7 |
| 500 | - | - | - |
| 30/4 | - | - | - |
| 4 | - | - | - |
| 26 - 10 | - | - | - |
| IEC | UL/CUL | CSA | IEC/EN 60079-7 |
| 32/4 | - | - | - |
| solid | stranded | Ferrule with/without plastic sleeve | |
| 0.14 - 6 | 0.14 - 6 | 0.14 - 4 | 0.14 - 4 |
| 0.14 - 1.5 | 0.14 - 1.5 | 0.14 - 1.5 | - |
| | | | 0.5 - 1.5 |
| 9 | | | |
| M3 | | | |
| 0.6 - 0.8 | | | |
| PA | | | |
| V0 | | | |

| Technical data | | | |
|-----------------------------|----------------------|-------------------------------------|----------------|
| Width | Length | Height NS 35/7,5 | |
| 6.2 | 92.7 | 61.7 | |
| I _{max} [A] | U _{max} [V] | max. Ø [mm ²] | AWG |
| 36 | 500 | 0.14 - 6 | 26 - 10 |
| IEC 60947-7-1/IEC 60947-7-2 | | | |
| IEC | UL/CUL | CSA | IEC/EN 60079-7 |
| 500 | - | - | - |
| 30/4 | - | - | - |
| 4 | - | - | - |
| 26 - 10 | - | - | - |
| IEC | UL/CUL | CSA | IEC/EN 60079-7 |
| 20 ³ /2.5 | - | - | - |
| solid | stranded | Ferrule with/without plastic sleeve | |
| 0.14 - 6 | 0.14 - 6 | 0.14 - 4 | 0.14 - 4 |
| 0.14 - 1.5 | 0.14 - 1.5 | 0.14 - 1.5 | - |
| | | | 0.5 - 1.5 |
| 9 | | | |
| M3 | | | |
| 0.6 - 0.8 | | | |
| PA | | | |
| V0 | | | |

| Technical data | | | |
|-----------------------------|----------------------|-------------------------------------|----------------|
| Width | Length | Height NS 35/7,5 | |
| 6.2 | 92.7 | 61.7 | |
| I _{max} [A] | U _{max} [V] | max. Ø [mm ²] | AWG |
| 36 | 500 | 0.14 - 6 | 26 - 10 |
| IEC 60947-7-1/IEC 60947-7-2 | | | |
| IEC | UL/CUL | CSA | IEC/EN 60079-7 |
| 500 | - | - | - |
| 30/4 | - | - | - |
| 4 | - | - | - |
| 26 - 10 | - | - | - |
| IEC | UL/CUL | CSA | IEC/EN 60079-7 |
| 20 ³ /2.5 | - | - | - |
| solid | stranded | Ferrule with/without plastic sleeve | |
| 0.14 - 6 | 0.14 - 6 | 0.14 - 4 | 0.14 - 4 |
| 0.14 - 1.5 | 0.14 - 1.5 | 0.14 - 1.5 | - |
| | | | 0.5 - 1.5 |
| 9 | | | |
| M3 | | | |
| 0.6 - 0.8 | | | |
| PA | | | |
| V0 | | | |

| Ordering data | | | |
|---------------|------------------|-----------|-------------|
| Type | I _{max} | Order No. | Pcs. / Pkt. |
| UT 4-PE/L/L | | 3214360 | 50 |
| UT 4-PE/L/N | | 3214361 | 50 |
| UT 4-PE/L/TG | | 3214365 | 50 |
| UT 4-PE/L/MT | | 3214364 | 50 |

| Ordering data | | | |
|---------------|------------------|-----------|-------------|
| Type | I _{max} | Order No. | Pcs. / Pkt. |
| UT 4-PE/L/L | | 3214360 | 50 |
| UT 4-PE/L/N | | 3214361 | 50 |
| UT 4-PE/L/TG | | 3214365 | 50 |
| UT 4-PE/L/MT | | 3214364 | 50 |

| Ordering data | | | |
|---------------|------------------|-----------|-------------|
| Type | I _{max} | Order No. | Pcs. / Pkt. |
| UT 4-PE/L/L | | 3214360 | 50 |
| UT 4-PE/L/N | | 3214361 | 50 |
| UT 4-PE/L/TG | | 3214365 | 50 |
| UT 4-PE/L/MT | | 3214364 | 50 |

| Accessories | | | |
|-------------|------|---------|----|
| FBS 2-6 | 28 A | 3030336 | 50 |
| FBS 3-6 | 28 A | 3030242 | 50 |
| FBS 4-6 | 28 A | 3030255 | 50 |
| FBS 5-6 | 28 A | 3030349 | 50 |
| FBS 10-6 | 28 A | 3030271 | 10 |
| FBS 20-6 | 28 A | 3030365 | 10 |
| SZS 0,6X3,5 | | 1205053 | 10 |

| Accessories | | | |
|-------------|------|---------|----|
| FBS 2-6 | 28 A | 3030336 | 50 |
| FBS 3-6 | 28 A | 3030242 | 50 |
| FBS 4-6 | 28 A | 3030255 | 50 |
| FBS 5-6 | 28 A | 3030349 | 50 |
| FBS 10-6 | 28 A | 3030271 | 10 |
| FBS 20-6 | 28 A | 3030365 | 10 |
| P-DI | | 3036783 | 50 |
| P-FIX | | 3038956 | 50 |
| P-CO | | 3036796 | 10 |
| P-FU 5X20 | | 3036806 | 10 |
| SZS 0,6X3,5 | | 1205053 | 10 |

| Accessories | | | |
|-------------|------|---------|----|
| FBS 2-6 | 28 A | 3030336 | 50 |
| FBS 3-6 | 28 A | 3030242 | 50 |
| FBS 4-6 | 28 A | 3030255 | 50 |
| FBS 5-6 | 28 A | 3030349 | 50 |
| FBS 10-6 | 28 A | 3030271 | 10 |
| FBS 20-6 | 28 A | 3030365 | 10 |
| S-MT | | 3247954 | 50 |
| SZS 0,6X3,5 | | 1205053 | 10 |

UC-TM 6, UCT-TM 6 or ZB 6 (see Catalog 5)

UC-TM 6, UCT-TM 6 or ZB 6 (see Catalog 5)

UC-TM 6, UCT-TM 6 or ZB 6 (see Catalog 5)

Modular terminal blocks

Modular terminal blocks - CLIPLINE complete

Screw connection, multi-level lever-type fuse terminal blocks with UT 4... PE foot

- Suitable for process technology thanks to applied for Ex nA approval
- For power and signal transmission in potentially explosive areas
- Compact design for maximum space saving
- Two function shafts mean that all potential distribution tasks can be undertaken at speed
- Test connection on both sides in safety lever
- Same shape as the UT 4-PE/L... feed-through and disconnect terminal blocks

CLIP PROJECT Planning enables the quick and convenient planning and configuration of fault-free terminal strips.

| Notes: |
|--|
| 1) If the fuse is faulty, the downstream circuit is not disconnected. |
| 2) The current is determined by the fuse used. |
| 3) The current is determined by the fuse used, the voltage by the light indicator. |
| 4) For maximum power dissipation, see Catalog 3. |

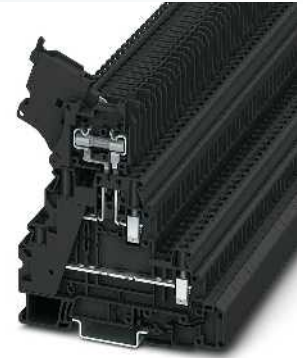
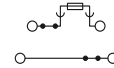

4 (6) mm², 36 A, multi-level terminal block, safety lever

| Dimensions | | [mm] |
|---|--------------------------|----------------------|
| Max. electrical data | | |
| Rated data lower level | | |
| Rated voltage | [V] | 500 ⁴⁾ |
| Nominal current / cross section | [A] / [mm ²] | 30/4 |
| Rated cross section | [mm ²] | 4 |
| Cross section range | AWG | 26 - 10 |
| Rated data, upper level | | |
| Nominal current / cross section | [A] / [mm ²] | 6.3 ²⁾ /1 |
| Connection capacity | | |
| 1 conductor | [mm ²] | 0.14 - 6 |
| Two conductors (of the same type) | [mm ²] | 0.14 - 1.5 |
| Two stranded conductors with a TWIN ferrule | [mm ²] | 0.14 - 1.5 |
| General data | | |
| Stripping length | [mm] | 9 |
| Screw thread | | M3 |
| Tightening torque | [Nm] | 0.6 - 0.8 |
| Insulating material | | PA |
| Inflammability class according to UL 94 | | V0 |

| Technical data | | | | |
|---------------------------------|----------------------|---------------------------|----------------|---------|
| Width | Length | Height NS 35/7,5 | | |
| 6.2 | 92.7 | 88.9 | | |
| I _{max} [A] | U _{max} [V] | max. Ø [mm ²] | AWG | |
| 36 ⁴⁾ | 500 ⁴⁾ | 0.14 - 6 | 26 - 10 | |
| IEC 60947-7-3 | | | | |
| IEC | UL/CUL | CSA | IEC/EN 60079-7 | |
| Rated voltage | | | | |
| 500 ⁴⁾ | - | - | - | |
| Nominal current / cross section | | | | |
| 30/4 | - | - | - | |
| Rated cross section | | | | |
| 4 | - | - | - | |
| Cross section range | | | | |
| 26 - 10 | - | - | - | |
| Rated data, upper level | | | | |
| IEC | UL/CUL | CSA | IEC/EN 60079-7 | |
| Nominal current / cross section | | | | |
| 6.3 ²⁾ /1 | -/- | - | - | |
| Connection capacity | | | | |
| solid | | stranded | | Ferrule |
| with/without plastic sleeve | | | | |
| 0.14 - 6 | 0.14 - 6 | 0.14 - 4 | 0.14 - 4 | |
| 0.14 - 1.5 | 0.14 - 1.5 | 0.14 - 1.5 | - | |
| | | | 0.5 - 1.5 | |

| Description | No. of pos. | Color |
|---|-------------|-------|
| Fuse terminal block , for mounting on NS 35..., for cartridge fuse inserts 5 x 20 mm | | black |
| Fuse terminal block , for mounting on NS 35..., for 5 x 20 cartridge fuse inserts | | black |
| with LED for 12-30 V DC, 0.31-0.95 mA ¹⁾ | | black |
| for 30-60 V AC/DC, 0.40-0.86 mA ¹⁾ | | black |
| for 110-250 V AC/DC, 0.41-0.96 mA ¹⁾ | | black |
| Disconnect terminal block , for mounting on NS 35... | | black |

| Ordering data | | | |
|--------------------|------------------|-----------|-------------|
| Type | I _{max} | Order No. | Pcs. / Pkt. |
| UT 4-L/HESI (5X20) | | 3214325 | 50 |

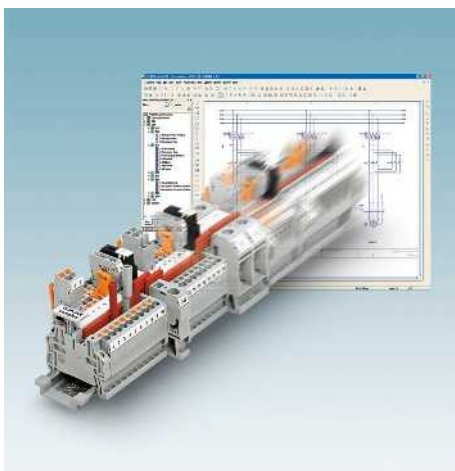

| Feed-through metal, in the shape of a 5 x 20 mm glass tube fuse insert | | | |
|--|----|-----|--|
| Jumper | | | |
| | 2 | red | |
| | 3 | red | |
| | 4 | red | |
| | 5 | red | |
| | 10 | red | |
| | 20 | red | |
| Screwdriver | | | |
| | | | |
| | | | |

| Accessories | | | |
|-------------|------|---------|----|
| DMET 5X20 | | 3032075 | 50 |
| FBS 2-6 | 28 A | 3030336 | 50 |
| FBS 3-6 | 28 A | 3030242 | 50 |
| FBS 4-6 | 28 A | 3030255 | 50 |
| FBS 5-6 | 28 A | 3030349 | 50 |
| FBS 10-6 | 28 A | 3030271 | 10 |
| FBS 20-6 | 28 A | 3030365 | 10 |
| SZS 0,6X3,5 | | 1205053 | 10 |

| | |
|--------------------------------|---|
| Lever labeling | UC-TM 5, UCT-TM 5 or ZB 5 (see Catalog 5) |
| Lateral groove labeling | UC-TM 6, UCT-TM 6 or ZB 6 (see Catalog 5) |

| | |
|--------------------------------|---|
| Lever labeling | UC-TM 5, UCT-TM 5 or ZB 5 (see Catalog 5) |
| Lateral groove labeling | UC-TM 6, UCT-TM 6 or ZB 6 (see Catalog 5) |

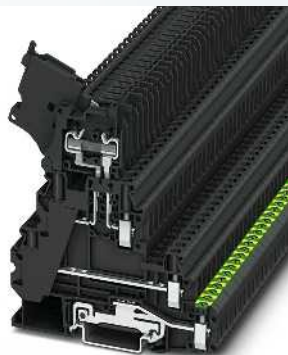
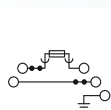

4 (6) mm², 36 A, multi-level terminal block, safety lever, PE foot

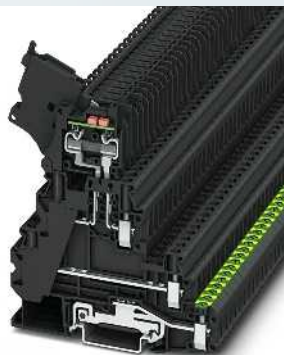
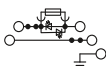

4 (6) mm², 36 A, multi-level terminal block, safety lever with LED, PE foot

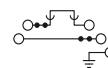

4 (6) mm², 36 A, multi-level terminal block, disconnect lever, PE foot

| Technical data | | | |
|-----------------------------|---------------|-------------------------------------|----------------|
| Width | Length | Height NS 35/7,5 | |
| 6.2 | 92.7 | 88.9 | |
| I_{max} [A] | U_{max} [V] | max. Ø [mm ²] | AWG |
| 36*) | 500*) | 0.14 - 6 | 26 - 10 |
| IEC 60947-7-2/IEC 60947-7-3 | | | |
| IEC | UL/CUL | CSA | IEC/EN 60079-7 |
| 500*) | - | - | - |
| 30/4 | - | - | - |
| 4 | - | - | - |
| 26 - 10 | - | - | - |
| IEC | UL/CUL | CSA | IEC/EN 60079-7 |
| 6.3*)/1 | -/- | - | - |
| solid | stranded | Ferrule with/without plastic sleeve | |
| 0.14 - 6 | 0.14 - 6 | 0.14 - 4 | 0.14 - 4 |
| 0.14 - 1.5 | 0.14 - 1.5 | 0.14 - 1.5 | - |
| | | | 0.5 - 1.5 |
| 9 | | | |
| M3 | | | |
| 0.6 - 0.8 | | | |
| PA | | | |
| V0 | | | |

| Technical data | | | |
|-----------------------------|---------------|-------------------------------------|----------------|
| Width | Length | Height NS 35/7,5 | |
| 6.2 | 92.7 | 88.9 | |
| I_{max} [A] | U_{max} [V] | max. Ø [mm ²] | AWG |
| 36*) | 500*) | 0.14 - 6 | 26 - 10 |
| IEC 60947-7-2/IEC 60947-7-3 | | | |
| IEC | UL/CUL | CSA | IEC/EN 60079-7 |
| 500*) | - | - | - |
| 30/4 | - | - | - |
| 4 | - | - | - |
| 26 - 10 | - | - | - |
| IEC | UL/CUL | CSA | IEC/EN 60079-7 |
| 6.3*)/1 | -/- | - | - |
| solid | stranded | Ferrule with/without plastic sleeve | |
| 0.14 - 6 | 0.14 - 6 | 0.14 - 4 | 0.14 - 4 |
| 0.14 - 1.5 | 0.14 - 1.5 | 0.14 - 1.5 | - |
| | | | 0.5 - 1.5 |
| 9 | | | |
| M3 | | | |
| 0.6 - 0.8 | | | |
| PA | | | |
| V0 | | | |

| Technical data | | | |
|-----------------------------|---------------|-------------------------------------|----------------|
| Width | Length | Height NS 35/7,5 | |
| 6.2 | 92.7 | 88.9 | |
| I_{max} [A] | U_{max} [V] | max. Ø [mm ²] | AWG |
| 36*) | 500*) | 0.14 - 6 | 26 - 10 |
| IEC 60947-7-1/IEC 60947-7-2 | | | |
| IEC | UL/CUL | CSA | IEC/EN 60079-7 |
| 500*) | - | - | - |
| 30/4 | - | - | - |
| 4 | - | - | - |
| 26 - 10 | - | - | - |
| IEC | UL/CUL | CSA | IEC/EN 60079-7 |
| 20/1 | -/- | - | - |
| solid | stranded | Ferrule with/without plastic sleeve | |
| 0.14 - 6 | 0.14 - 6 | 0.14 - 4 | 0.14 - 4 |
| 0.14 - 1.5 | 0.14 - 1.5 | 0.14 - 1.5 | - |
| | | | 0.5 - 1.5 |
| 9 | | | |
| M3 | | | |
| 0.6 - 0.8 | | | |
| PA | | | |
| V0 | | | |

| Ordering data | | | |
|-----------------------|-----------|-----------|-------------|
| Type | I_{max} | Order No. | Pcs. / Pkt. |
| UT 4-PE/L/HESI (5X20) | | 3214320 | 50 |

| Ordering data | | | |
|------------------------------|-----------|-----------|-------------|
| Type | I_{max} | Order No. | Pcs. / Pkt. |
| UT 4-PE/L/HESILED 24 (5X20) | | 3214321 | 50 |
| UT 4-PE/L/HESILED 60 (5X20) | | 3214322 | 50 |
| UT 4-PE/L/HESILED 250 (5X20) | | 3214323 | 50 |

| Ordering data | | | |
|----------------|-----------|-----------|-------------|
| Type | I_{max} | Order No. | Pcs. / Pkt. |
| UT 4-PE/L/HEDI | | 3214324 | 50 |

| Accessories | | | |
|-------------|------|---------|----|
| DMET 5X20 | | 3032075 | 50 |
| FBS 2-6 | 28 A | 3030336 | 50 |
| FBS 3-6 | 28 A | 3030242 | 50 |
| FBS 4-6 | 28 A | 3030255 | 50 |
| FBS 5-6 | 28 A | 3030349 | 50 |
| FBS 10-6 | 28 A | 3030271 | 10 |
| FBS 20-6 | 28 A | 3030365 | 10 |
| SZS 0,6X3,5 | | 1205053 | 10 |

| Accessories | | | |
|-------------|------|---------|----|
| DMET 5X20 | | 3032075 | 50 |
| FBS 2-6 | 28 A | 3030336 | 50 |
| FBS 3-6 | 28 A | 3030242 | 50 |
| FBS 4-6 | 28 A | 3030255 | 50 |
| FBS 5-6 | 28 A | 3030349 | 50 |
| FBS 10-6 | 28 A | 3030271 | 10 |
| FBS 20-6 | 28 A | 3030365 | 10 |
| SZS 0,6X3,5 | | 1205053 | 10 |

| Accessories | | | |
|-------------|------|---------|----|
| FBS 2-6 | 28 A | 3030336 | 50 |
| FBS 3-6 | 28 A | 3030242 | 50 |
| FBS 4-6 | 28 A | 3030255 | 50 |
| FBS 5-6 | 28 A | 3030349 | 50 |
| FBS 10-6 | 28 A | 3030271 | 10 |
| FBS 20-6 | 28 A | 3030365 | 10 |
| SZS 0,6X3,5 | | 1205053 | 10 |

UC-TM 5, UCT-TM 5 or ZB 5 (see Catalog 5)
UC-TM 6, UCT-TM 6 or ZB 6 (see Catalog 5)

UC-TM 5, UCT-TM 5 or ZB 5 (see Catalog 5)
UC-TM 6, UCT-TM 6 or ZB 6 (see Catalog 5)

UC-TM 5, UCT-TM 5 or ZB 5 (see Catalog 5)
UC-TM 6, UCT-TM 6 or ZB 6 (see Catalog 5)

Modular terminal blocks

Modular terminal blocks - CLIPLINE complete

Screw connection test disconnect terminal block with UK 4-SD test isolating plug

This disconnect terminal block offers numerous advantages especially for testing in measuring and signal circuits:

- Simultaneous interruption of individual or multiple neighboring disconnect terminal blocks by using the PS 6-DI-SD isolating plug
- Safe, uninterruptible looping in of measuring devices in the circuit with the aid of the PS 6-CT-SD test isolating plug
- Safe contacting of the potentials after opening the disconnect point through use of the PS 6-VT-SD test isolating plug
- Terminal points in the test isolating plugs allow individual test applications to be wired.
- Easy potential distribution in the terminal strip with insertion bridges

CLIP PROJECT Planning enables the quick and convenient planning and configuration of fault-free terminal strips.

Circuit examples

- Normal operation: no plug inserted
- Measurement checking: looping in a measuring device with the PS 6-CT-SD test isolating plug
- Current transformer short circuit: measurement split between two positions

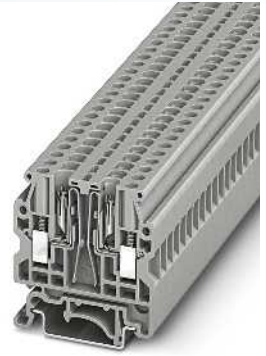

4 (6) mm², test disconnect terminal block

| | | |
|---|--------------------------|-----------|
| Dimensions | | [mm] |
| Dimensions | | [mm] |
| Max. electrical data | | |
| Rated data | | |
| Rated voltage | [V] | 500 |
| Nominal current / cross section | [A] / [mm ²] | 10/4 |
| Rated cross section | [mm ²] | 4 |
| Cross section range | AWG | 20 - 10 |
| Connection capacity | | |
| 1 conductor | [mm ²] | 0.5 - 6 |
| Two conductors (of the same type) | [mm ²] | 0.5 - 1.5 |
| Two stranded conductors with a TWIN ferrule | [mm ²] | 0.5 - 1.5 |
| General data | | |
| Stripping length | [mm] | 9 |
| Screw thread | | M3 |
| Tightening torque | [Nm] | 0.5 - 0.6 |
| Insulating material | | PA |
| Inflammability class according to UL 94 | | V0 |

| Technical data | | | |
|---|----------------------|-----------------------------------|----------------|
| Width | Length | Height NS 35/7,5 | |
| 6.2 | 45.5 | 47.3 | |
| Width | Length | Height NS 32 | |
| 6.2 | 45.5 | 52.2 | |
| I _{max} [A] | U _{max} [V] | max. Ø [mm ²] | AWG |
| 10 | 500 | 0.2 - 6 | 20 - 10 |
| IEC 60947-7-1 | | | |
| IEC | UL/CUL | CSA | IEC/EN 60079-7 |
| with/without plastic sleeve | | | |
| solid | | stranded | |
| 1 conductor | | Two conductors (of the same type) | |
| 0.5 - 6 | | 0.5 - 1.5 | |
| Two stranded conductors with a TWIN ferrule | | 0.5 - 1.5 | |

| Description | No. of pos. | Color |
|---|-------------|-------|
| Test disconnect terminal block, for mounting on NS 35 | | gray |
| Isolating plug | | gray |
| Test isolating plug | | green |
| Test isolating plug | | red |

| Description | No. of pos. | Color |
|------------------------------|-------------|-------|
| Cover, width 2.2 mm | | gray |
| Insertion bridge, insulated | | |
| | 2 | gray |
| | 3 | gray |
| | 10 | gray |
| Partition plate, 1.5 mm wide | | gray |
| Screwdriver | | |
| Lateral groove labeling | | |

| Ordering data | | | |
|---------------|------------------|-----------|-------------|
| Type | I _{max} | Order No. | Pcs. / Pkt. |
| UK 4-SD | | 3246861 | 50 |

| Accessories | | | |
|-------------------------|-------------|-------|-------------|
| Description | No. of pos. | Color | |
| D-UK 4-SD | | | 3246862 50 |
| EB 2-6 | 11 A | | 0201155 100 |
| EB 3-6 | 11 A | | 0201142 100 |
| EB 10-6 | 11 A | | 0201139 10 |
| ATP-UK | | | 3003224 50 |
| SF-SL 0,6X3,5-100 S-VDE | | | 1212587 10 |

UC-TM 6, UCT-TM 6 or ZB 6 (see Catalog 5)

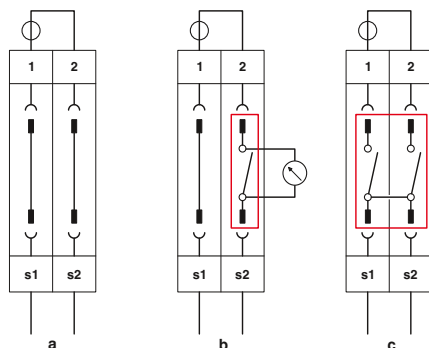



Isolating plug, disconnect function only



1.5 (2.5) mm² test isolating plug, contacts before the signal isolation

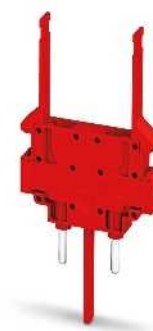

1.5 (2.5) mm² test isolating plug, contacts after the signal isolation

| Technical data | | | |
|----------------|----------|-------------------------------------|----------------|
| Width | Length | Height NS 35/7,5 | |
| 6.2 | 39.3 | - | |
| Width | Length | Height NS 32 | |
| 6.2 | 39.3 | - | |
| | | max. Ø [mm ²] | AWG |
| | | - | - |
| IEC | UL/CUL | CSA | IEC/EN 60079-7 |
| - | - | - | - |
| - | - | - | - |
| - | - | - | - |
| - | - | - | - |
| solid | stranded | Ferrule with/without plastic sleeve | |
| - | - | - | - |
| - | - | - | - |
| PA | | | |
| V0 | | | |

| Technical data | | | |
|-----------------------|-----------------------|-------------------------------------|----------------|
| Width | Length | Height NS 35/7,5 | |
| 6.2 | 39.3 | - | |
| Width | Length | Height NS 32 | |
| 6.2 | 39.3 | - | |
| | | max. Ø [mm ²] | AWG |
| I _{max.} [A] | U _{max.} [V] | 0.5 - 2.5 | 20 - 14 |
| 8 | 250 | | |
| IEC 60947-7-1 | | | |
| IEC | UL/CUL | CSA | IEC/EN 60079-7 |
| 250 | - | - | - |
| 6 | - | - | - |
| 2.5 | - | - | - |
| 20 - 14 | - | - | - |
| solid | stranded | Ferrule with/without plastic sleeve | |
| 0.5 - 2.5 | 0.5 - 2.5 | 0.5 - 1.5 | 0.5 - 1.5 |
| - | - | - | - |
| 7 | | | |
| M3 | | | |
| 0.3 - 0.5 | | | |
| PA | | | |
| V0 | | | |

| Technical data | | | |
|-----------------------|-----------------------|-------------------------------------|----------------|
| Width | Length | Height NS 35/7,5 | |
| 6.2 | 39.3 | - | |
| Width | Length | Height NS 32 | |
| 6.2 | 39.3 | - | |
| | | max. Ø [mm ²] | AWG |
| I _{max.} [A] | U _{max.} [V] | 0.5 - 2.5 | 20 - 14 |
| 8 | 250 | | |
| IEC 60947-7-1 | | | |
| IEC | UL/CUL | CSA | IEC/EN 60079-7 |
| 250 | - | - | - |
| 6 | - | - | - |
| 2.5 | - | - | - |
| 20 - 14 | - | - | - |
| solid | stranded | Ferrule with/without plastic sleeve | |
| 0.5 - 2.5 | 0.5 - 2.5 | 0.5 - 1.5 | 0.5 - 1.5 |
| - | - | - | - |
| 7 | | | |
| M3 | | | |
| 0.3 - 0.5 | | | |
| PA | | | |
| V0 | | | |

| Ordering data | | |
|---------------|-----------|-------------|
| Type | Order No. | Pcs. / Pkt. |
| PS 6-DI-SD | 3246856 | 50 |

| Ordering data | | |
|---------------|-----------|-------------|
| Type | Order No. | Pcs. / Pkt. |
| PS 6-CT-SD | 3246857 | 50 |

| Ordering data | | |
|---------------|-----------|-------------|
| Type | Order No. | Pcs. / Pkt. |
| PS 6-VT-SD | 3246858 | 50 |

| Accessories | | |
|-------------|--|--|
| | | |

| Accessories | | |
|---------------|---------|----|
| SZF 1-0,6X3,5 | 1204517 | 10 |

| Accessories | | |
|---------------|---------|----|
| SZF 1-0,6X3,5 | 1204517 | 10 |

UC-TM 6, UCT-TM 6 or ZB 6 (see Catalog 5)

UC-TM 6, UCT-TM 6 or ZB 6 (see Catalog 5)

UC-TM 6, UCT-TM 6 or ZB 6 (see Catalog 5)

Modular terminal blocks

Modular terminal blocks - CLIPLINE complete

Fast connection

QTCU 2,5-TWIN-MT hybrid knife disconnect terminal block

The advantages of the different

connection methods are as follows:

- The TWIN fast connection is used inside the control cabinet and the universal screw connection is used on the end customer side
- Compact design and high current carrying capacity of 20 A
- Testing facility on both sides of the disconnect point

S-MT switching lock

- The optional switching lock snaps in and effectively prevents accidental switching

A test plug with a 2.3 mm diameter is available for measuring lines. All measurement and test work can be completed at speed using test adapters for 4 mm diameter test plugs and the modular test plugs.

| Notes: |
|---|
| 1) The max. load current must not be exceeded by the total current of all connected conductors. |
| 2) see Catalog 3. |

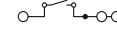

2.5 (2.5) mm², 20 A, knife disconnect terminal block, three connections

| Dimensions | | [mm] | |
|---|--------------------------|------------|------------|
| Max. electrical data | | | |
| Rated data, fast connection | | | |
| Rated voltage | [V] | 400 | - |
| Nominal current / cross section | [A] / [mm ²] | 20/2.5 | - |
| Rated cross section | [mm ²] | 2.5 | - |
| Cross section range | AWG | 20 - 14 | - |
| Connection cross section in acc. with DIN VDE 0295 | | | |
| H05V(Z) / H07V(Z) | [mm ²] | 0.5 - 2.5 | |
| [Litz wires Ø ≥ 0.19 mm] | AWG | 20 - 14 | |
| Frequency of connections with the same cross section | | 100 | |
| Rated data, screw connection | | | |
| Rated voltage | [V] | 400 | - |
| Nominal current / cross section | [A] / [mm ²] | 20/2.5 | - |
| Rated cross section | [mm ²] | 2.5 | - |
| Cross section range | AWG | 26 - 10 | - |
| Connection capacity screw connection | | | |
| 1 conductor | [mm ²] | 0.14 - 6 | 0.14 - 4 |
| Two conductors (of the same type) | [mm ²] | 0.14 - 1.5 | 0.14 - 1.5 |
| Two conductors with a TWIN ferrule | [mm ²] | | 0.5 - 2.5 |
| General data | | | |
| Stripping length | [mm] | 9 | |
| Screw thread | | M3 | |
| Tightening torque | [Nm] | 0.6 - 0.8 | |
| Insulating material | | PA | |
| Inflammability class according to UL 94 | | V0 | |

| Technical data | | | | |
|---|----------------------|---------------------------|-------------------------------------|-----------|
| Width | Length | Height NS 35/7.5 | | |
| 6.2 | 79.3 | 42.8 | | |
| I _{max} [A] | U _{max} [V] | max. Ø [mm ²] | AWG | |
| 20 ¹⁾ | 400 | 0.14 - 6 | 26 - 10 | |
| IEC 60947-7-1 | | | | |
| IEC | UL/CUL | CSA | IEC/EN 60079-7 | |
| IEC 60947-7-1 | | | | |
| IEC | UL/CUL | CSA | IEC/EN 60079-7 | |
| Connection capacity screw connection | | | | |
| | solid | stranded | Ferrule with/without plastic sleeve | |
| 1 conductor | 0.14 - 6 | 0.14 - 4 | 0.14 - 4 | 0.14 - 4 |
| Two conductors (of the same type) | 0.14 - 1.5 | 0.14 - 1.5 | 0.14 - 1.5 | - |
| Two conductors with a TWIN ferrule | | | | 0.5 - 2.5 |
| General data | | | | |
| Stripping length | [mm] | 9 | | |
| Screw thread | | M3 | | |
| Tightening torque | [Nm] | 0.6 - 0.8 | | |
| Insulating material | | PA | | |
| Inflammability class according to UL 94 | | V0 | | |

| Description | No. of pos. | Color |
|--|-------------|-------|
| Terminal block , for mounting on NS 35... | | gray |
| | | blue |

| Ordering data | | | |
|---------------------|------------------|-----------|-------------|
| Type | I _{max} | Order No. | Pcs. / Pkt. |
| QTCU 2,5-TWIN-MT | | 3050304 | 50 |
| QTCU 2,5-TWIN-MT BU | | 3050317 | 50 |

| | | |
|---|----|--------|
| Cover , width 2.2 mm | | gray |
| Jumper | | |
| | 2 | red |
| | 3 | red |
| | 4 | red |
| | 5 | red |
| | 10 | red |
| | 20 | red |
| Partition plate , 2 mm width | | gray |
| Switching lock , plug-in ²⁾ | | white |
| Test adapter , 4-mm test socket hole | | gray |
| Test plug metal part , 2.3 mm Ø | | silver |
| Insulating sleeve , for MPS metal part | | red |
| Modular test plug , for the individual assembly of test pin strips | | red |
| Screwdriver | | |
| Lateral groove labeling | | |

| Accessories | | | |
|--|------|-----------|-------------|
| D-QTCU 2,5-TWIN-MT | | Order No. | Pcs. / Pkt. |
| D-QTCU 2,5-TWIN-MT | | 3050511 | 50 |
| FBS 2-6 | 20 A | 3030336 | 50 |
| FBS 3-6 | 20 A | 3030242 | 50 |
| FBS 4-6 | 20 A | 3030255 | 50 |
| FBS 5-6 | 20 A | 3030349 | 50 |
| FBS 10-6 | 20 A | 3030271 | 10 |
| FBS 20-6 | 20 A | 3030365 | 10 |
| ATP-QTC TWIN | | 3206212 | 50 |
| S-MT | | 3247954 | 50 |
| PAI-4-N GY | | 3032871 | 10 |
| MPS-MT | | 0201744 | 10 |
| MPS-IH RD | | 0201676 | 10 |
| PS-6 | | 3030996 | 10 |
| SZF 1-0,6X3,5 | | 1204517 | 10 |
| UC-TMF 6, UCT-TMF 6 or ZBF 6 (see Catalog 5) | | | |

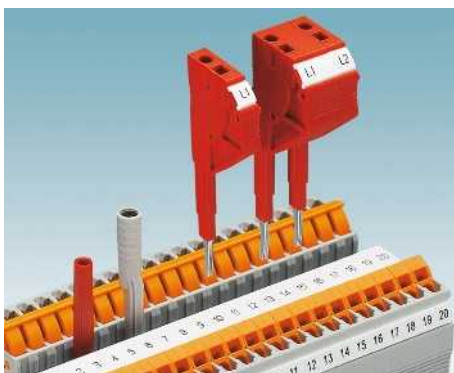

QTC 2,5-QUATTRO... fast connection feed-through and ground terminal blocks

- The fastest conductor connection for signal and low-spectrum power wiring
- Large packing density with a maximum conductor cross section of 2.5 mm²
- Compact design

Notes:
 1) The max. load current must not be exceeded by the total current of all connected conductors.

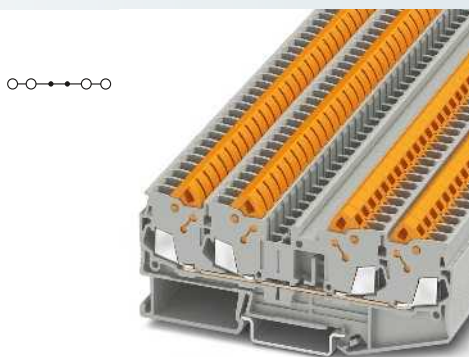

2.5 (2.5) mm², 24 A, feed-through terminal block, four connections

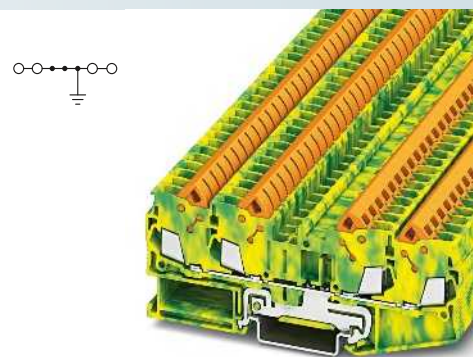

2.5 (2.5) mm², ground terminal block, four connections

| Technical data | | | | |
|--|----------------------|---------------------------|----------------|--|
| Width | Length | Height NS 35/7,5 | | |
| 6.2 | 102.4 | 39.3 | | |
| I _{max} [A] | U _{max} [V] | max. Ø [mm ²] | AWG | |
| 24 ¹⁾ | 800 | 0.5 - 2.5 | 20 - 14 | |
| IEC 60947-7-1 | | | | |
| IEC | UL/CUL | CSA | IEC/EN 60079-7 | |
| 800 | - | - | - | |
| 24/2.5 | - | - | - | |
| 2.5 | - | - | - | |
| 20 - 14 | - | - | - | |
| Connection cross section in acc. with DIN VDE 0295 | | | | |
| H05V(Z) / H07V(Z) | [mm ²] | 0.5 - 2.5 | | |
| [Litz wires Ø ≥ 0.19 mm] | AWG | 20 - 14 | | |
| Frequency of connections with the same cross section | | 100 | | |
| General data | | | | |
| Insulating material | PA | | | |
| Inflammability class according to UL 94 | V0 | | | |

| Technical data | | | | |
|---|--------|---------------------------|----------------|--|
| Width | Length | Height NS 35/7,5 | | |
| 6.2 | 102.4 | 39.3 | | |
| | | max. Ø [mm ²] | AWG | |
| | | 0.5 - 2.5 | 20 - 14 | |
| IEC 60947-7-2 | | | | |
| IEC | UL/CUL | CSA | IEC/EN 60079-7 | |
| - | - | - | - | |
| - | - | - | - | |
| 2.5 | - | - | - | |
| 20 - 14 | - | - | - | |
| 0.5 - 2.5 | | | | |
| 20 - 14 | | | | |
| 100 | | | | |
| General data | | | | |
| Insulating material | PA | | | |
| Inflammability class according to UL 94 | V0 | | | |

| Ordering data | | | |
|--------------------|------------------|-----------|-------------|
| Type | I _{max} | Order No. | Pcs. / Pkt. |
| QTC 2,5-QUATTRO | | 3206446 | 50 |
| QTC 2,5-QUATTRO BU | | 3206447 | 50 |

| Ordering data | | | |
|--------------------|-----------|-------------|--|
| Type | Order No. | Pcs. / Pkt. | |
| QTC 2,5-QUATTRO-PE | 3206448 | 50 | |

| Accessories | | | | |
|-------------------|------|---------|-----|--|
| D-QTC 2,5-QUATTRO | | 3206449 | 50 | |
| DS-QTC 2,5 | | 3206607 | 50 | |
| FBS 2-6 | 24 A | 3030336 | 50 | |
| FBS 3-6 | 24 A | 3030242 | 50 | |
| FBS 4-6 | 24 A | 3030255 | 50 | |
| FBS 5-6 | 24 A | 3030349 | 50 | |
| FBS 10-6 | 24 A | 3030271 | 10 | |
| FBS 20-6 | 24 A | 3030365 | 10 | |
| ATP-QTC QUATTRO | | 3206225 | 50 | |
| PAI-4-N GY | | 3032871 | 10 | |
| MPS-MT | | 0201744 | 10 | |
| MPS-IH RD | | 0201676 | 10 | |
| PS-6 | | 3030996 | 10 | |
| STP 5-2-ZB | | 3037643 | 100 | |
| SZF 1-0,6X3,5 | | 1204517 | 10 | |

| Accessories | | | | |
|-------------------|--|---------|-----|--|
| D-QTC 2,5-QUATTRO | | 3206449 | 50 | |
| DS-QTC 2,5 | | 3206607 | 50 | |
| FBS 2-6 | | 3030336 | 50 | |
| FBS 3-6 | | 3030242 | 50 | |
| FBS 4-6 | | 3030255 | 50 | |
| FBS 5-6 | | 3030349 | 50 | |
| FBS 10-6 | | 3030271 | 10 | |
| FBS 20-6 | | 3030365 | 10 | |
| ATP-QTC QUATTRO | | 3206225 | 50 | |
| PAI-4-N GY | | 3032871 | 10 | |
| MPS-MT | | 0201744 | 10 | |
| MPS-IH RD | | 0201676 | 10 | |
| PS-6 | | 3030996 | 10 | |
| STP 5-2-ZB | | 3037643 | 100 | |
| SZF 1-0,6X3,5 | | 1204517 | 10 | |

| | |
|---------------------------------|--|
| Center groove labeling | UC-TM 6, UCT-TM 6 or ZB 6 (see Catalog 5) |
| Center and side groove labeling | UC-TMF 6, UCT-TMF 6 or ZBF 6 (see Catalog 5) |

| | |
|---------------------------------|--|
| Center groove labeling | UC-TM 6, UCT-TM 6 or ZB 6 (see Catalog 5) |
| Center and side groove labeling | UC-TMF 6, UCT-TMF 6 or ZBF 6 (see Catalog 5) |

| Dimensions | | |
|--|----|--------------------------|
| | | [mm] |
| Max. electrical data | | |
| Rated data | | |
| Rated voltage | | [V] |
| Nominal current / cross section | | [A] / [mm ²] |
| Rated cross section | | [mm ²] |
| Cross section range | | AWG |
| Connection cross section in acc. with DIN VDE 0295 | | |
| H05V(Z) / H07V(Z) | | [mm ²] |
| [Litz wires Ø ≥ 0.19 mm] | | AWG |
| Frequency of connections with the same cross section | | |
| General data | | |
| Insulating material | PA | |
| Inflammability class according to UL 94 | V0 | |
| Description | | |
| No. of pos. | | Color |
| Terminal block, for mounting on NS 35... | | gray |
| Ground terminal block, for mounting on NS 35... | | green-yellow |

| | | |
|--|----|--------|
| Cover, width 2.2 mm | | gray |
| End cover segment, for covering multi-conductor terminal blocks when two-conductor terminal blocks are aligned | | gray |
| Jumper | | |
| | 2 | red |
| | 3 | red |
| | 4 | red |
| | 5 | red |
| | 10 | red |
| | 20 | red |
| Partition plate, 2 mm width | | gray |
| Test adapter, 4-mm test socket hole | | gray |
| Test plug metal part, 2.3 mm Ø | | silver |
| Insulating sleeve, for MPS metal part | | red |
| Modular test plug, for the individual assembly of test pin strips | | red |
| Double marker carrier, can be snapped into all terminal blocks with a width of 5.2 mm or above and a zack marker strip center groove, can be marked with ZB 5 or ZBF 5 | | gray |
| Screwdriver | | |

| | |
|---------------------------------|--|
| Center groove labeling | UC-TM 6, UCT-TM 6 or ZB 6 (see Catalog 5) |
| Center and side groove labeling | UC-TMF 6, UCT-TMF 6 or ZBF 6 (see Catalog 5) |



Valve connector with energy-reducing function

Page 177



Valve connector for outdoor applications

Page 180



Valve connector superseal connector

Page 181



Valve connector Deutsch connector

Page 182



M12 power cable

Page 184



M12 connector with crimp connection

Page 185



M12 Y-distributor for power connectors

Page 186



M12 assembled cables for outdoor applications

Page 187



H and T-distributors, 6.0 mm² Cable connectors, 6.0 mm²

Page 188



Panel feed-throughs, 2.5 mm² and 6.0 mm² Assembled cables, 2.5 mm²

Page 191



HEAVYCON EVO housing Type D15 and D25

Page 196



HEAVYCON contact inserts Type B, BB series and HS series

Page 198



HEAVYCON EVO housing
Type B, for EMC applications

Page 202



HEAVYCON HPR housing
Type B, for railway applications

Page 214



CES cable entry system
Sealing frames with cone-shaped
cable sleeves

Page 222



Plastic, brass, EMC, and
Ex cable glands

Page 224

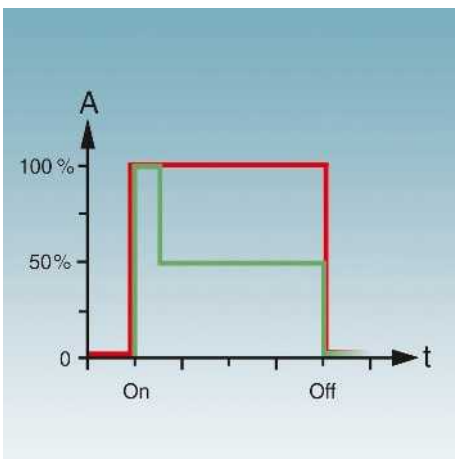
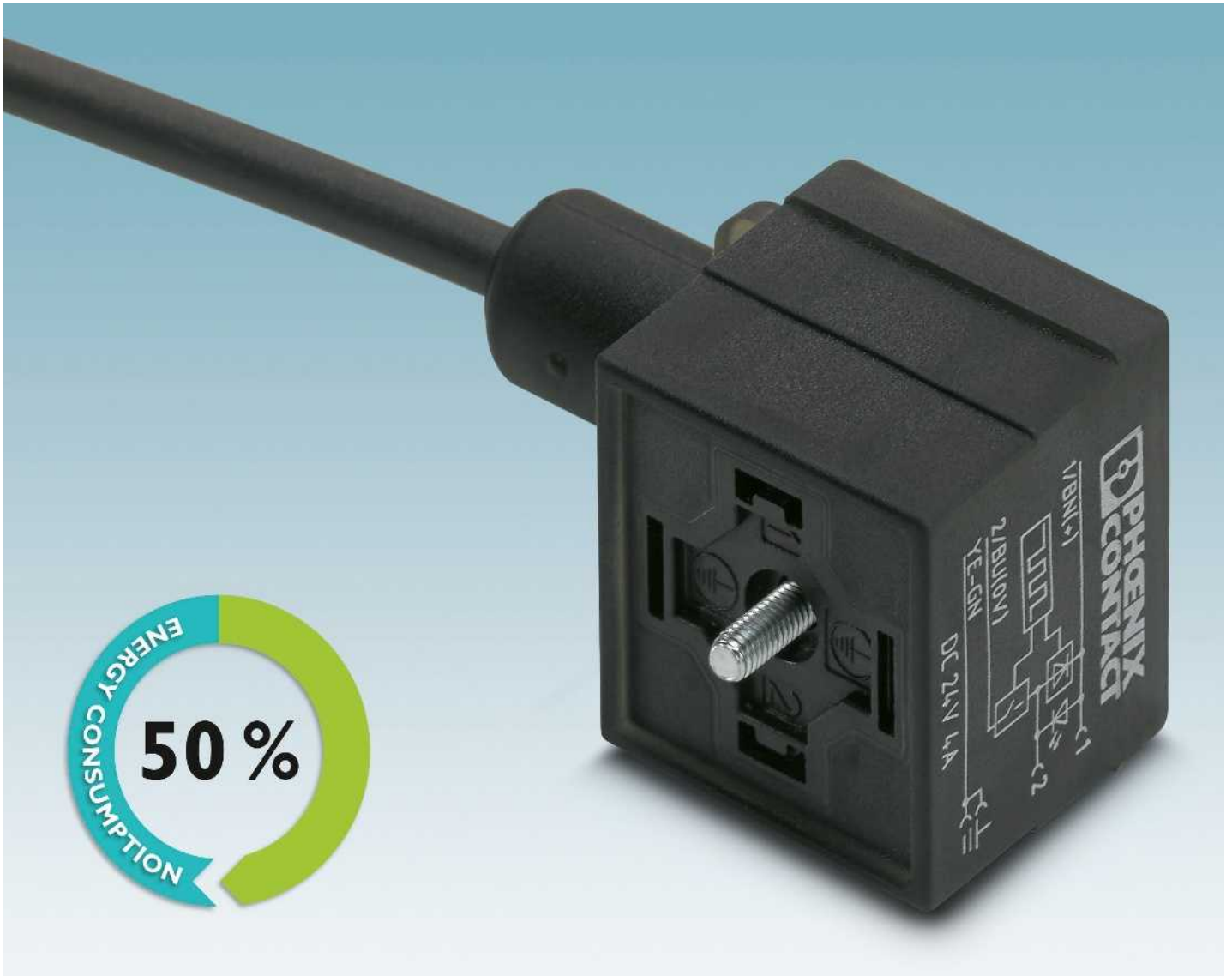

Save energy

The new valve connectors with energy-reducing function are characterized by up to 50% reduced current consumption compared to conventional versions.



Save costs

After controlling the valve, the holding current is reduced to 50% by the energy-reducing function. This means that power supply units with smaller dimensions can be used.



Compatible with the standard

The functionality and compatibility of valve connectors corresponds to the familiar standard. Integration in existing systems can be easily accomplished.

Valve connector with energy-reducing function

- Energy-reducing function by means of holding current limiting device



Valve connector with freewheeling diode, type A, 3-pos.



Valve connector with freewheeling diode, type B, 3-pos.

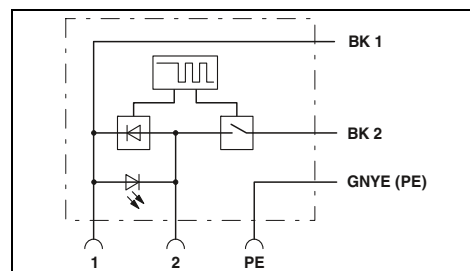
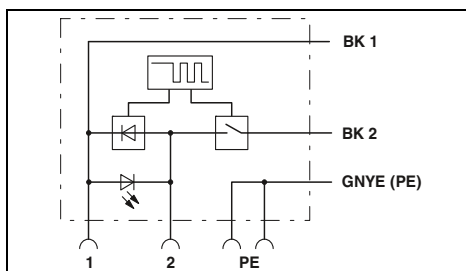

Technical data

Technical data

| | |
|--|-----------------|
| General data | |
| Valve connector according to: | EN 175301-803 |
| Degree of protection | IP67 |
| Electrical data | |
| Rated voltage | 24 V DC |
| Rated current | 4 A |
| Contact resistance | ≤ 5 mΩ |
| Material data | |
| Material contact valve connector | CuSn |
| Material contact surface valve connector | Ag |
| Material housing valve connector | TPU |
| Mechanical data | |
| No. of pos. | 3 |
| Temperature data | |
| Valve connectors | [°C] -25 ... 80 |

| | |
|--|-----------------|
| General data | |
| Valve connector according to: | EN 175301-803 |
| Degree of protection | IP67 |
| Electrical data | |
| Rated voltage | 24 V DC |
| Rated current | 1 A |
| Contact resistance | ≤ 5 mΩ |
| Material data | |
| Material contact valve connector | CuSn |
| Material contact surface valve connector | Ag |
| Material housing valve connector | TPU |
| Mechanical data | |
| No. of pos. | 3 |
| Temperature data | |
| Valve connectors | [°C] -25 ... 80 |

Ordering data

Ordering data

| Description | Cable length |
|--|--------------|
| Assembled cable, with valve connector, and free conductor end | 1.5 m |
| | 3 m |
| | 5 m |
| | 10 m |

| Type | Order No. | Pcs. / Pkt. |
|------------------------------|-----------|-------------|
| SAC-3P- 1,5-PUR/A-1L-R-ES 4A | 1400827 | 1 |
| SAC-3P- 3,0-PUR/A-1L-R-ES 4A | 1401131 | 1 |
| SAC-3P- 5,0-PUR/A-1L-R-ES 4A | 1401136 | 1 |
| SAC-3P-10,0-PUR/A-1L-R-ES 4A | 1401168 | 1 |

| Type | Order No. | Pcs. / Pkt. |
|---------------------------|-----------|-------------|
| SAC-3P- 1,5-PUR/B-1L-R-ES | 1401294 | 1 |
| SAC-3P- 3,0-PUR/B-1L-R-ES | 1401295 | 1 |
| SAC-3P- 5,0-PUR/B-1L-R-ES | 1401338 | 1 |
| SAC-3P-10,0-PUR/B-1L-R-ES | 1401339 | 1 |

Sensor/actuator cabling - assembled cables

Valve connector with energy-reducing function

– Energy-reducing function by means of holding current limiting device



Valve connector with freewheeling diode, type BI, 3-pos.



Valve connector with freewheeling diode, type C, 3-pos.

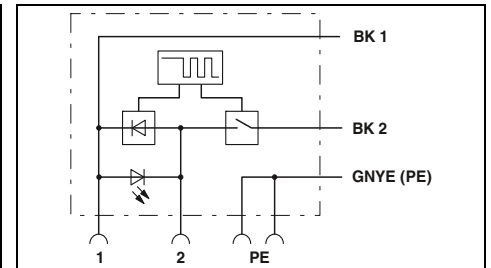
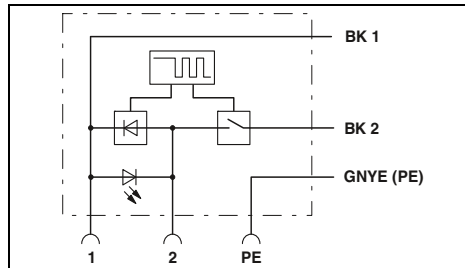

| | | Technical data | | | Technical data | | |
|--|--------------|----------------------------|-----------|-------------|---------------------------|-----------|-------------|
| General data | | | | | | | |
| Valve connector according to: | | - | | | EN 175301-803 | | |
| Degree of protection | | IP67 | | | IP67 | | |
| Electrical data | | | | | | | |
| Rated voltage | | 24 V DC | | | 24 V DC | | |
| Rated current | | 1 A | | | 1 A | | |
| Contact resistance | | ≤ 5 mΩ | | | ≤ 5 mΩ | | |
| Material data | | | | | | | |
| Material contact valve connector | | CuSn | | | CuSn | | |
| Material contact surface valve connector | | Ag | | | Ag | | |
| Material housing valve connector | | TPU | | | TPU | | |
| Mechanical data | | | | | | | |
| No. of pos. | | 3 | | | 3 | | |
| Temperature data | | | | | | | |
| Valve connectors | | [-25 ... 80] °C | | | [-25 ... 80] °C | | |
| | | Ordering data | | | Ordering data | | |
| Description | Cable length | Type | Order No. | Pcs. / Pkt. | Type | Order No. | Pcs. / Pkt. |
| Assembled cable, with valve connector, and free conductor end | 1.5 m | SAC-3P- 1,5-PUR/BI-1L-R-ES | 1401340 | 1 | SAC-3P- 1,5-PUR/C-1L-R-ES | 1401434 | 1 |
| | 3 m | SAC-3P- 3,0-PUR/BI-1L-R-ES | 1401350 | 1 | SAC-3P- 3,0-PUR/C-1L-R-ES | 1401435 | 1 |
| | 5 m | SAC-3P- 5,0-PUR/BI-1L-R-ES | 1401358 | 1 | SAC-3P- 5,0-PUR/C-1L-R-ES | 1401448 | 1 |
| | 10 m | SAC-3P-10,0-PUR/BI-1L-R-ES | 1401359 | 1 | SAC-3P-10,0-PUR/C-1L-R-ES | 1401465 | 1 |



Valve connector with freewheeling diode,
type CI, 3-pos.

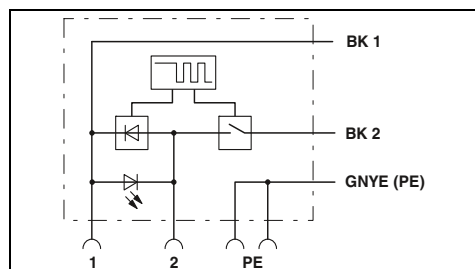

Technical data

-
IP67
24 V DC
1 A
≤ 5 mΩ

CuSn
Ag
TPU

3

-25 ... 80

Ordering data

| Type | Order No. | Pcs. / Pkt. |
|----------------------------|-----------|-------------|
| SAC-3P- 1,5-PUR/CI-1L-R-ES | 1401466 | 1 |
| SAC-3P- 3,0-PUR/CI-1L-R-ES | 1401542 | 1 |
| SAC-3P- 5,0-PUR/CI-1L-R-ES | 1401544 | 1 |
| SAC-3P-10,0-PUR/CI-1L-R-ES | 1401617 | 1 |

Sensor/actuator cabling and industrial connectors

Sensor/actuator cabling - assembled cables

Valve connector for outdoor applications

- Stainless steel central screw
- Additional silicone seal ensures IP66K protection



Valve connector with Zener diode, type A, 3-pos.



Valve connector with 2 LEDs, type AD pressure switch, 5-pos.

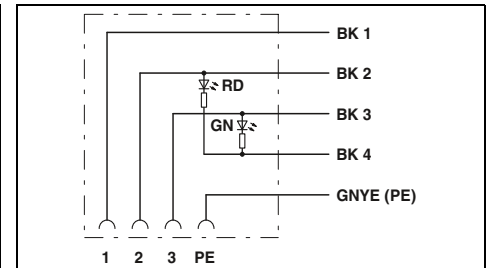
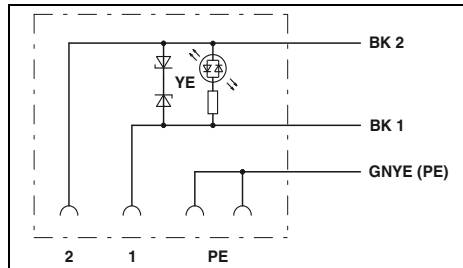

| | |
|--|----------------------|
| General data | |
| Valve connector according to: | EN 175301-803 |
| Degree of protection | IP65/IP66K/IP67/IP68 |
| Electrical data | |
| Rated voltage | 24 V |
| Rated current | 4 A |
| Contact resistance | ≤ 5 mΩ |
| Material data | |
| Material contact valve connector | CuSn |
| Material contact surface valve connector | Sn |
| Material housing valve connector | TPU |
| Mechanical data | |
| No. of pos. | 3 |
| Temperature data | |
| Valve connectors | [°C] -40 ... 85 |

| Technical data | | |
|--|--|--|
| General data | | |
| Valve connector according to: | | |
| Degree of protection | | |
| Electrical data | | |
| Rated voltage | | |
| Rated current | | |
| Contact resistance | | |
| Material data | | |
| Material contact valve connector | | |
| Material contact surface valve connector | | |
| Material housing valve connector | | |
| Mechanical data | | |
| No. of pos. | | |
| Temperature data | | |
| Valve connectors | | |

| Technical data | | |
|--|--|--|
| General data | | |
| Valve connector according to: | | |
| Degree of protection | | |
| Electrical data | | |
| Rated voltage | | |
| Rated current | | |
| Contact resistance | | |
| Material data | | |
| Material contact valve connector | | |
| Material contact surface valve connector | | |
| Material housing valve connector | | |
| Mechanical data | | |
| No. of pos. | | |
| Temperature data | | |
| Valve connectors | | |

| Ordering data | |
|--|--------------|
| Description | Cable length |
| Assembled cable, with valve connector, and free conductor end | 1.5 m |
| | 3 m |
| | 5 m |
| | 10 m |

| Ordering data | | |
|---------------------------|-----------|-------------|
| Type | Order No. | Pcs. / Pkt. |
| SAC-3P- 1,5-PUO/A-1L-Z OD | 1407287 | 1 |
| SAC-3P- 3,0-PUO/A-1L-Z OD | 1407288 | 1 |
| SAC-3P- 5,0-PUO/A-1L-Z OD | 1407289 | 1 |
| SAC-3P-10,0-PUO/A-1L-Z OD | 1407290 | 1 |

| Ordering data | | |
|--------------------------|-----------|-------------|
| Type | Order No. | Pcs. / Pkt. |
| SAC-5P- 1,5-PUO/AD-2L OD | 1407291 | 1 |
| SAC-5P- 3,0-PUO/AD-2L OD | 1407292 | 1 |
| SAC-5P- 5,0-PUO/AD-2L OD | 1407293 | 1 |
| SAC-5P-10,0-PUO/AD-2L OD | 1407294 | 1 |

**Valve connector,
superseal connector**

– For mobile hydraulic applications



Superseal,
2-pos.



Superseal,
2-pos.

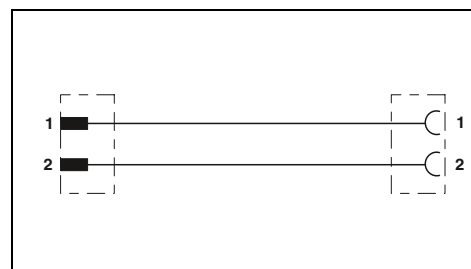
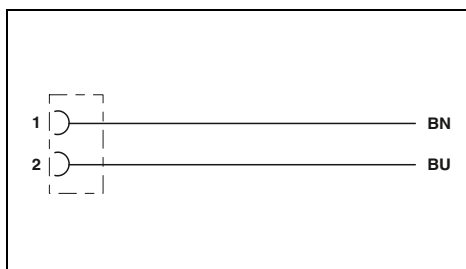

| | Technical data | Technical data |
|-----------------------|-----------------|----------------------------|
| General data | | |
| Degree of protection | IP67 | IP67 |
| Electrical data | | |
| Rated voltage | 24 V | 24 V |
| Rated current | 8 A | 8 A |
| Contact resistance | ≤ 5 mΩ | ≤ 5 mΩ |
| Material data | | |
| Contact material | PhCuSn | CuZn (pin)/PhCuSn (socket) |
| Material of grip body | PA | PA |
| Mechanical data | | |
| No. of pos. | 2 | 2 |
| Temperature data | | |
| Plug/socket | -20 ... 85 [°C] | -20 ... 85 |

| | | Ordering data | | | Ordering data | | |
|---|--------------|-----------------------|-----------|-------------|-----------------------------|-----------|-------------|
| Description | Cable length | Type | Order No. | Pcs. / Pkt. | Type | Order No. | Pcs. / Pkt. |
| Assembled cable, with straight socket and free cable end | 1.5 m | SAC-2P- 1,5-PUR/SUSFS | 1410748 | 1 | | | |
| | 3 m | SAC-2P- 3,0-PUR/SUSFS | 1410749 | 1 | | | |
| | 5 m | SAC-2P- 5,0-PUR/SUSFS | 1410750 | 1 | | | |
| | 10 m | SAC-2P-10,0-PUR/SUSFS | 1410751 | 1 | | | |
| Assembled cable, with straight plug and free cable end | 1.5 m | SAC-2P-SUSMS/ 1,5-PUR | 1410752 | 1 | | | |
| | 3 m | SAC-2P-SUSMS/ 3,0-PUR | 1410753 | 1 | | | |
| | 5 m | SAC-2P-SUSMS/ 5,0-PUR | 1410755 | 1 | | | |
| | 10 m | SAC-2P-SUSMS/10,0-PUR | 1410756 | 1 | | | |
| Assembled cable, with straight plug and straight socket | 0.3 m | | | | SAC-2P-SUSMS/ 0,3-PUR/SUSFS | 1410757 | 1 |
| | 0.6 m | | | | SAC-2P-SUSMS/ 0,6-PUR/SUSFS | 1410759 | 1 |
| | 1.5 m | | | | SAC-2P-SUSMS/ 1,5-PUR/SUSFS | 1410760 | 1 |
| | 3 m | | | | SAC-2P-SUSMS/ 3,0-PUR/SUSFS | 1410761 | 1 |

Sensor/actuator cabling and industrial connectors

Sensor/actuator cabling - assembled cables

Valve connector, Deutsch DT06-2S connector

– For mobile hydraulic applications



Valve connector, Deutsch DT06-2S,
2-pos.



Valve connector, Deutsch DT06-2S,
with 1 LED, 2-pos.

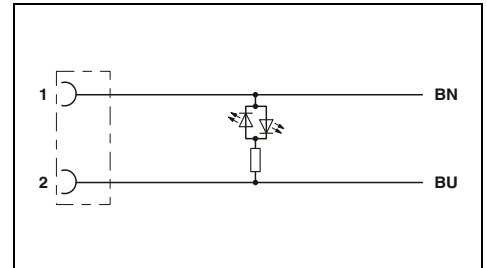
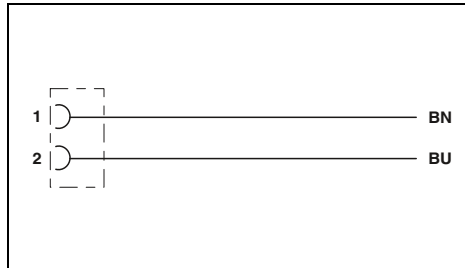

Technical data

| | |
|--------------------------|-----------------|
| General data | |
| Degree of protection | IP67 |
| Electrical data | |
| Rated voltage | 48 V |
| Rated current | 8 A |
| Contact resistance | ≤ 8 mΩ |
| Material data | |
| Contact material | Cu alloy |
| Contact surface material | Nickel-plated |
| Material of grip body | PA |
| Mechanical data | |
| No. of pos. | 2 |
| Temperature data | |
| Plug/socket | [°C] -20 ... 85 |

Technical data

| | |
|--------------------------|-----------------|
| General data | |
| Degree of protection | IP67 |
| Electrical data | |
| Rated voltage | 24 V |
| Rated current | 8 A |
| Contact resistance | ≤ 8 mΩ |
| Material data | |
| Contact material | Cu alloy |
| Contact surface material | Nickel-plated |
| Material of grip body | PA |
| Mechanical data | |
| No. of pos. | 2 |
| Temperature data | |
| Plug/socket | [°C] -20 ... 85 |

Ordering data

| Description | Cable length | Type | Order No. | Pcs. / Pkt. |
|---|--------------|----------------------|-----------|-------------|
| Assembled cable, with straight socket and free cable end | 1.5 m | SAC-2P- 1,5-PUR/DTFS | 1410723 | 1 |
| | 3 m | SAC-2P- 3,0-PUR/DTFS | 1410724 | 1 |
| | 5 m | SAC-2P- 5,0-PUR/DTFS | 1410726 | 1 |
| | 10 m | SAC-2P-10,0-PUR/DTFS | 1410727 | 1 |

Ordering data

| Description | Cable length | Type | Order No. | Pcs. / Pkt. |
|---|--------------|-------------------------|-----------|-------------|
| Assembled cable, with straight socket and free cable end | 1.5 m | SAC-2P- 1,5-PUR/DTFS-1L | 1410728 | 1 |
| | 3 m | SAC-2P- 3,0-PUR/DTFS-1L | 1410729 | 1 |
| | 5 m | SAC-2P- 5,0-PUR/DTFS-1L | 1410730 | 1 |
| | 10 m | SAC-2P-10,0-PUR/DTFS-1L | 1410731 | 1 |



Valve connector, Deutsch DT06-2S, with suppressor diode, 2-pos.

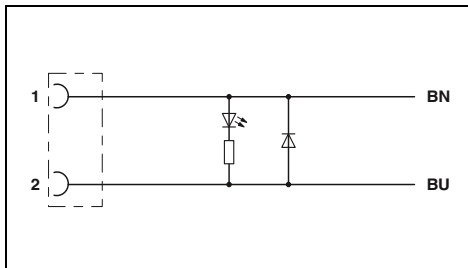

Technical data

IP67

24 V

3 A

≤ 8 mΩ

Cu alloy

Nickel-plated

PA

2

-20 ... 85

Ordering data

| Type | Order No. | Pcs. / Pkt. |
|---------------------------|-----------|-------------|
| SAC-2P- 1,5-PUR/DTFS-1L-S | 1410732 | 1 |
| SAC-2P- 3,0-PUR/DTFS-1L-S | 1410733 | 1 |
| SAC-2P- 5,0-PUR/DTFS-1L-S | 1410734 | 1 |
| SAC-2P-10,0-PUR/DTFS-1L-S | 1410735 | 1 |

Sensor/actuator cabling and industrial connectors

Sensor/actuator cabling - assembled cables

M12-SPEEDCON power cable, 2-pos.+PE, unshielded

Free end



M12 plug, SPEEDCON



Ordering data

Ordering data

Ordering data

| Free end | Order No. | Order No. | Order No. |
|----------|-----------|-----------|--------------|
| | 1 m | 1411636 | 1 m 1411640 |
| | 2 m | 1411637 | 2 m 1411641 |
| | 5 m | 1411638 | 5 m 1411642 |
| | 10 m | 1411639 | 10 m 1411643 |
| | 1 m | 1411644 | |
| | 2 m | 1411645 | |
| | 5 m | 1411646 | |
| | 10 m | 1411647 | |
| | 1 m | 1411648 | |
| | 2 m | 1411649 | |
| | 5 m | 1411650 | |
| | 10 m | 1411651 | |

| Cable description | Cable type | Color coding | Pin assignment |
|-------------------|------------|---|----------------|
| PVC - black | PVC | BK1 1 BK2 2 GNYE | 1 3 PE |

Technical data

| | | M12 |
|---|------|---|
| Rated voltage | [V] | 230 |
| Rated current | [A] | 16 |
| Contact resistance | | ≤ 3 mΩ |
| Inflammability class in acc. with UL 94 | | V0 |
| Material contact M12 | | CuZn |
| Material contact surface M12 | | Au |
| Material handle M12 | | TPU, hardly inflammable, self-extinguishing |
| Material, knurls | | Zinc die-cast, nickel-plated |
| Degree of protection | | IP67 |
| Temperature data | | |
| Plug/socket | [°C] | -25 ... 105 |

**M12 connector
with crimp connection**

Notes:
Order crimp contacts separately

Ethernet



SERCOS
the automation bus



M12 Plug, straight,
4-pos.

Ethernet



SERCOS
the automation bus



M12 Plug, angled,
4-pos.

| General data | |
|---|------------------|
| M12 circular connector according to: | IEC 61076-2-101 |
| Pollution degree | 3 |
| Degree of protection | IP67 |
| Connection method | Crimp connection |
| Cable Diameter | 5 mm ... 8 mm |
| Electrical data | |
| Rated voltage | 60 V |
| Rated current | 4 A |
| Insulation resistance | ≥ 10 GΩ |
| Material data | |
| Contact carrier material | PA |
| Inflammability class according to UL 94 | HB |
| Temperature data | |
| Plug/socket | -25 ... 85 [°C] |

| Technical data | | |
|------------------|--|--|
| IEC 61076-2-101 | | |
| 3 | | |
| IP67 | | |
| Crimp connection | | |
| 5 mm ... 8 mm | | |
| Electrical data | | |
| 60 V | | |
| 4 A | | |
| ≥ 10 GΩ | | |
| Material data | | |
| PA | | |
| HB | | |
| Temperature data | | |
| -25 ... 85 | | |

| Technical data | | |
|------------------|--|--|
| IEC 61076-2-101 | | |
| 3 | | |
| IP67 | | |
| Crimp connection | | |
| 5 mm ... 8 mm | | |
| Electrical data | | |
| 60 V | | |
| 4 A | | |
| ≥ 10 GΩ | | |
| Material data | | |
| PA | | |
| HB | | |
| Temperature data | | |
| -25 ... 85 | | |

| Ordering data | |
|--|----------|
| Description | Coding |
| Bus system plug, PROFINET, 4-pos., shielded with Pg9 screw connection | D - data |

| Ordering data | | |
|-----------------------|-----------|-------------|
| Type | Order No. | Pcs. / Pkt. |
| SACC-M12MSD-4CT SH PN | 1411046 | 1 |

| Ordering data | | |
|-----------------------|-----------|-------------|
| Type | Order No. | Pcs. / Pkt. |
| SACC-M12MRD-4CT SH PN | 1411047 | 1 |

| Accessories | |
|--|--|
| Crimp contacts , for conductor cross section: 0.34 mm ² ... 0.5 mm ² | |
| Crimping pliers - For turned contacts; 0.14 ... 4 mm ² | |

| Accessories | | |
|------------------------------|---------|-----|
| SACC-CC1,0-T-0,50-M AU PU100 | 1412351 | 100 |
| CRIMPFOX-1,6/2,5-ED-4,0 | 1687419 | 1 |

| Accessories | | |
|------------------------------|---------|-----|
| SACC-CC1,0-T-0,50-M AU PU100 | 1412351 | 100 |
| CRIMPFOX-1,6/2,5-ED-4,0 | 1687419 | 1 |

M12 Y-distributor for power connectors



Y-distributor, T-coded,
4-pos.

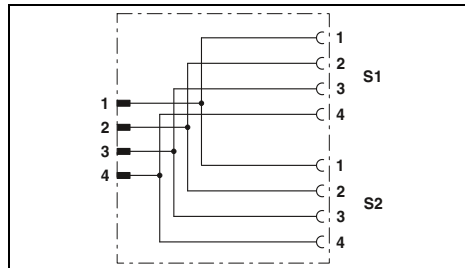

| General data | |
|---|-----------------|
| Pollution degree | 3 |
| Degree of protection | IP65/IP67 |
| Electrical data | |
| Rated voltage | 60 V |
| Rated current | 12 A (at 40°C) |
| Material data | |
| Contact material | CuZn |
| Contact surface material | Ni/Au |
| Inflammability class according to UL 94 | HB |
| Temperature data | |
| Plug/socket | [-25 ... 80 °C] |

Technical data

| Ordering data | | | | |
|---|-----------------|--------------------|-----------|-------------|
| Description | Center distance | Type | Order No. | Pcs. / Pkt. |
| Y-distributor, M12-SPEEDCON, unshielded, M12 plug (T-coded) to 2 x M12 socket (T-coded) | 21 mm | SAC-4PY-MT/2XFT VP | 1410632 | 5 |

M12 assembled cables for outdoor applications

- For DeviceNet™
- For CANopen®



Bus system cable, 5-pos.



Bus system cable, 5-pos.

| | Technical data | | Technical data | |
|---|----------------------|-------------|----------------------|--|
| Electrical data | | | | |
| Rated voltage | 60 V | | 60 V | |
| Rated current | 4 A | | 4 A | |
| Contact resistance | ≤ 5 mΩ | | ≤ 5 mΩ | |
| Material data | | | | |
| Contact material | CuSn | | CuSn | |
| Contact surface material | Ni/Au | | Ni/Au | |
| Contact carrier material | PP | | PP | |
| Inflammability class according to UL 94 | V0 | | V0 | |
| Mechanical data | | | | |
| No. of pos. | 5 | | 5 | |
| Pollution degree | 3 | | 3 | |
| Degree of protection | IP65/IP67/IP68/IP69K | | IP65/IP67/IP68/IP69K | |
| Temperature data | | | | |
| Plug/socket | [°C] | -40 ... 105 | -40 ... 105 | |
| Cable, fixed installation | [°C] | -40 ... 105 | -40 ... 105 | |

| | | Ordering data | | | Ordering data | | |
|---|--------------|-----------------------------|-----------|-------------|--------------------------------|-----------|-------------|
| Description | Cable length | Type | Order No. | Pcs. / Pkt. | Type | Order No. | Pcs. / Pkt. |
| Bus system cable, 5-pos., A-coded, FRNC, halogen-free, black, shielded, straight M12 socket to free cable ends | 2 m | SAC-5P- 2,0-92X/M12FS SH OD | 1410474 | 1 | | | |
| | 5 m | SAC-5P- 5,0-92X/M12FS SH OD | 1410494 | 1 | | | |
| | 10 m | SAC-5P-10,0-92X/M12FS SH OD | 1410496 | 1 | | | |
| Bus system cable, 5-pos., A-coded, FRNC, halogen-free, black, shielded, straight M12 plug to free cable ends | 2 m | SAC-5P-M12MS/ 2,0-92X SH OD | 1410471 | 1 | | | |
| | 5 m | SAC-5P-M12MS/ 5,0-92X SH OD | 1410472 | 1 | | | |
| | 10 m | SAC-5P-M12MS/10,0-92X SH OD | 1410473 | 1 | | | |
| Bus system cable, 5-pos., A-coded, FRNC, halogen-free, black, shielded, straight M12 plug to straight M12 socket | 2 m | | | | SAC-5P-M12MS/2,0-92X/M12FSSHOD | 1410467 | 1 |
| | 5 m | | | | SAC-5P-M12MS/5,0-92X/M12FSSHOD | 1410470 | 1 |

H-distributor, 6.0 mm²

- Can be used as a H-distributor with continuous master cable
- Can be used as a star distributor
- Can be used as a Y-distributor with a test connection
- Touch-proof in accordance with DIN EN 50274



With four QUICKON nuts,
4+PE-pos.



Without QUICKON nut,
4+PE-pos.

| | Technical data | | Technical data | |
|---|--|--|--|--|
| | Black | Gray | Black | Gray |
| General data | | | | |
| Degree of protection | IP68/IP69K | IP68/IP69K | IP68/IP69K | IP68/IP69K |
| Electrical data | | | | |
| Rated voltage (III/3) | 690 V | 690 V | 690 V | 690 V |
| Rated surge voltage | 6 kV | 6 kV | 6 kV | 6 kV |
| Rated current | 40 A | 40 A | 40 A | 40 A |
| Surge voltage category/pollution degree | III/3 | III/3 | III/3 | III/3 |
| Material data | | | | |
| Housing material | PA | PA | PA | PA |
| Contact material | Cu | Cu | Cu | Cu |
| Inflammability class according to UL 94 | V0 | V0 | V0 | V0 |
| Mechanical data | | | | |
| Impact category | IK07 | IK07 | IK07 | IK07 |
| Color | Black | Gray | Black | Gray |
| Connector data QUICKON connection | | | | |
| Core insulation | PVC/PE/TPE/rubber | PVC/PE/TPE/rubber | PVC/PE/TPE/rubber | PVC/PE/TPE/rubber |
| Structure of individual litz wire/ smallest wire diameter | VDE 0295 class 1 to 6/ min. 0.15 mm | VDE 0295 class 1 to 6/ min. 0.15 mm | VDE 0295 class 1 to 6/ min. 0.15 mm | VDE 0295 class 1 to 6/ min. 0.15 mm |
| Connection frequency | max. 10 | max. 10 | max. 10 | max. 10 |
| Conductor cross section [mm ²] solid/stranded | 2.5 mm ² ... 6 mm ² / 2.5 mm ² ... 6 mm ² | 2.5 mm ² ... 6 mm ² / 2.5 mm ² ... 6 mm ² | 2.5 mm ² ... 6 mm ² / 2.5 mm ² ... 6 mm ² | 2.5 mm ² ... 6 mm ² / 2.5 mm ² ... 6 mm ² |
| Conductor cross section [AWG] | 14 ... 10 | 14 ... 10 | 14 ... 10 | 14 ... 10 |
| Temperature data | | | | |
| Ambient temperature (operation) | -40°C ... 80°C | -40°C ... 80°C | -40°C ... 80°C | -40°C ... 80°C |
| Temperature when conductor connected | -5°C ... 50°C | -5°C ... 50°C | -5°C ... 50°C | -5°C ... 50°C |
| | Ordering data | | Ordering data | |
| Description | Order No. | Pcs. / Pkt. | Order No. | Pcs. / Pkt. |
| | Black | | Gray | |
| H-distributor, with four QUICKON nuts and one sealing bolt, for cable diameters: | | | | |
| 9 mm ... 14 mm | 1411422 | 1 | 1411428 | 1 |
| 12 mm ... 20 mm | 1411425 | 1 | 1411429 | 1 |
| H-distributor, without QUICKON nuts | | | | |
| | | | 1411426 | 1 |
| QUICKON nut, for connections up to 6.0 mm², for cable diameter: | | | | |
| 9 mm ... 14 mm | | | 1410409 | 1 |
| 12 mm ... 20 mm | | | 1410406 | 1 |
| | | | 1410407 | 1 |
| | | | 1410405 | 1 |

T-distributor, 6.0 mm²

- Can be used as a T-distributor with continuous master cable
- Touch-proof in accordance with DIN EN 50274



With three QUICKON nuts,
4+PE-pos.



With two QUICKON nuts,
4+PE-pos.

| | Technical data | | Technical data | |
|---|--|--|--|--|
| | Black | Gray | Black | Gray |
| General data | | | | |
| Degree of protection | IP68/IP69K | IP68/IP69K | IP68/IP69K | IP68/IP69K |
| Electrical data | | | | |
| Rated voltage (III/3) | 690 V | 690 V | 690 V | 690 V |
| Rated surge voltage | 6 kV | 6 kV | 6 kV | 6 kV |
| Rated current | 40 A | 40 A | 40 A | 40 A |
| Surge voltage category/pollution degree | III/3 | III/3 | III/3 | III/3 |
| Material data | | | | |
| Housing material | PA | PA | PA | PA |
| Contact material | Cu | Cu | Cu | Cu |
| Inflammability class according to UL 94 | V0 | V0 | V0 | V0 |
| Mechanical data | | | | |
| Impact category | IK07 | IK07 | IK07 | IK07 |
| Color | Black | Gray | Black | Gray |
| Connector data QUICKON connection | | | | |
| Core insulation | PVC/PE/TPE/rubber | PVC/PE/TPE/rubber | PVC/PE/TPE/rubber | PVC/PE/TPE/rubber |
| Structure of individual litz wire/ smallest wire diameter | VDE 0295 class 1 to 6/ min. 0.15 mm | VDE 0295 class 1 to 6/ min. 0.15 mm | VDE 0295 class 1 to 6/ min. 0.15 mm | VDE 0295 class 1 to 6/ min. 0.15 mm |
| Connection frequency | max. 10 | max. 10 | max. 10 | max. 10 |
| Conductor cross section [mm ²] solid/stranded | 2.5 mm ² ... 6 mm ² / 2.5 mm ² ... 6 mm ² | 2.5 mm ² ... 6 mm ² / 2.5 mm ² ... 6 mm ² | 2.5 mm ² ... 6 mm ² / 2.5 mm ² ... 6 mm ² | 2.5 mm ² ... 6 mm ² / 2.5 mm ² ... 6 mm ² |
| Conductor cross section [AWG] | 14 ... 10 | 14 ... 10 | 14 ... 10 | 14 ... 10 |
| Temperature data | | | | |
| Ambient temperature (operation) | -40°C ... 80°C | -40°C ... 80°C | -40°C ... 80°C | -40°C ... 80°C |
| Temperature when conductor connected | -5°C ... 50°C | -5°C ... 50°C | -5°C ... 50°C | -5°C ... 50°C |

| Description | Ordering data | | | | Ordering data | | | |
|---|---------------|-------------|-----------|-------------|---------------|-------------|-----------|-------------|
| | Order No. | Pcs. / Pkt. | Order No. | Pcs. / Pkt. | Order No. | Pcs. / Pkt. | Order No. | Pcs. / Pkt. |
| | Black | | Gray | | Black | | Gray | |
| T-distributor, with three QUICKON nuts, for cable diameter: 9 mm ... 14 mm 12 mm ... 20 mm | 1411414 | 1 | 1411418 | 1 | | | | |
| | 1411415 | 1 | 1411419 | 1 | | | | |
| T-distributor, with two QUICKON nuts, for cable diameter: 9 mm ... 14 mm 12 mm ... 20 mm | | | | | 1411416 | 1 | 1411420 | 1 |
| | | | | | 1411417 | 1 | 1411421 | 1 |
| QUICKON nut, for connections up to 6.0 mm², for cable diameter: 9 mm ... 14 mm 12 mm ... 20 mm | | | | | 1410409 | 1 | 1410407 | 1 |
| | | | | | 1410406 | 1 | 1410405 | 1 |

Installation system - QPD installation system

Cable connectors, 6.0 mm²

- The QUICKON connections at opposite ends feature different position markings and mechanical coding
- Touch-proof in accordance with DIN EN 50274



With two QUICKON nuts,
4+PE-pos.



With one QUICKON nut,
4+PE-pos.

| | Technical data | | Technical data | |
|---|--|--|--|--|
| | Black | Gray | Black | Gray |
| General data | | | | |
| Degree of protection | IP68/IP69K | IP68/IP69K | IP68/IP69K | IP68/IP69K |
| Electrical data | | | | |
| Rated voltage (III/3) | 690 V | 690 V | 690 V | 690 V |
| Rated surge voltage | 6 kV | 6 kV | 6 kV | 6 kV |
| Rated current | 40 A | 40 A | 40 A | 40 A |
| Surge voltage category/pollution degree | III/3 | III/3 | III/3 | III/3 |
| Material data | | | | |
| Housing material | PA | PA | PA | PA |
| Contact material | Cu | Cu | Cu | Cu |
| Inflammability class according to UL 94 | V0 | V0 | V0 | V0 |
| Mechanical data | | | | |
| Impact category | IK07 | IK07 | IK07 | IK07 |
| Color | Black | Gray | Black | Gray |
| Connector data QUICKON connection | | | | |
| Core insulation | PVC/PE/TPE/rubber | PVC/PE/TPE/rubber | PVC/PE/TPE/rubber | PVC/PE/TPE/rubber |
| Structure of individual litz wire/ smallest wire diameter | VDE 0295 class 1 to 6/ min. 0.15 mm | VDE 0295 class 1 to 6 / min. 0.15 mm | VDE 0295 class 1 to 6/ min. 0.15 mm | VDE 0295 class 1 to 6/ min. 0.15 mm |
| Connection frequency | max. 10 | max. 10 | max. 10 | max. 10 |
| Conductor cross section [mm ²] solid/stranded | 2.5 mm ² ... 6 mm ² / 2.5 mm ² ... 6 mm ² | 2.5 mm ² ... 6 mm ² / 2.5 mm ² ... 6 mm ² | 2.5 mm ² ... 6 mm ² / 2.5 mm ² ... 6 mm ² | 2.5 mm ² ... 6 mm ² / 2.5 mm ² ... 6 mm ² |
| Conductor cross section [AWG] | 10 ... 14 | 10 ... 14 | 10 ... 14 | 10 ... 14 |
| Temperature data | | | | |
| Ambient temperature (operation) | -40°C ... 80°C | -40°C ... 80°C | -40°C ... 80°C | -40°C ... 80°C |
| Temperature when conductor connected | -5°C ... 50°C | -5°C ... 50°C | -5°C ... 50°C | -5°C ... 50°C |
| | Ordering data | | | |
| Description | Order No. | Pcs. / Pkt. | Order No. | Pcs. / Pkt. |
| | Black | | Gray | |
| Cable connector, with two QUICKON nuts, for cable diameters: 9 mm ... 14 mm 12 mm ... 20 mm | 1410410 | 1 | 1410413 | 1 |
| | 1410412 | 1 | 1410414 | 1 |
| Cable connector, with one QUICKON nut, for cable diameters: 9 mm ... 14 mm 12 mm ... 20 mm | | | | |
| QUICKON nut, for connections up to 6.0 mm², for cable diameter: 9 mm ... 14 mm 12 mm ... 20 mm | | | | |
| | | | 1410415 | 1 |
| | | | 1410416 | 1 |
| | | | 1410417 | 1 |
| | | | 1410418 | 1 |
| | | | 1410409 | 1 |
| | | | 1410406 | 1 |
| | | | 1410407 | 1 |
| | | | 1410405 | 1 |

Panel feed-throughs, 2.5 mm² with push-in connection

- Devices no longer need to be opened in order to connect the cables
- User-friendly connection, even on devices that are difficult to access
- For internal push-in connection, solid conductors are simply stripped and inserted in the connection
- Touch-proof in accordance with DIN EN 50274



With one QUICKON nut, 4+PE-pos.

| Technical data | | |
|---|--|--|
| | Black | Gray |
| General data | | |
| Degree of protection | IP68/IP69K | IP68/IP69K |
| Electrical data | | |
| Rated voltage (III/3) | 690 V | 690 V |
| Rated surge voltage | 6 kV | 6 kV |
| Rated current | 20 A | 20 A |
| Surge voltage category/pollution degree | III/3 | III/3 |
| Material data | | |
| Housing material | PA | PA |
| Contact material | Cu | Cu |
| Inflammability class according to UL 94 | V0 | V0 |
| Mechanical data | | |
| Impact category | IK07 | IK07 |
| Color | Black | Black |
| Connector data QUICKON connection | | |
| Core insulation | PVC/PE/Rubber/TPE | PVC/PE/Rubber/TPE |
| Structure of individual litz wire/ smallest wire diameter | VDE 0295 class 1 to 6/ min. 0.15 mm | VDE 0295 class 1 to 6/ min. 0.15 mm |
| Connection frequency | max. 10 | max. 10 |
| Conductor cross section [mm ²] solid/stranded | 1 mm ² ... 2.5 mm ² / 1 mm ² ... 2.5 mm ² | 1 mm ² ... 2.5 mm ² / 1 mm ² ... 2.5 mm ² |
| Conductor cross section [AWG] | 16 ... 14 | 16 ... 14 |
| Temperature data | | |
| Ambient temperature (operation) | -40°C ... 80°C | -40°C ... 80°C |
| Temperature when conductor connected | -5°C ... 50°C | -5°C ... 50°C |

| Ordering data | | | | |
|--|-----------|-------------|-----------|-------------|
| Description | Order No. | Pcs. / Pkt. | Order No. | Pcs. / Pkt. |
| | Black | | Gray | |
| Panel feed-through , with M25 x 1.5 mounting flange, with QUICKON nut, for cable diameters: | | | | |
| 6 mm ... 11 mm | 1411432 | 1 | 1411434 | 1 |
| 9 mm ... 16 mm | 1411433 | 1 | 1411435 | 1 |

Sensor/actuator cabling and industrial connectors

Installation system - QPD installation system

Panel feed-throughs, 2.5 mm² for intrinsically safe circuits

- Devices no longer need to be opened in order to connect the cables
- User-friendly connection, even on devices that are difficult to access
- Touch-proof in accordance with DIN EN 50274

Notes:
Intended for applications in intrinsically safe circuits according to EN 60079-11 and EN 60079-14.



With litz wires,
4+PE-pos.



With manual solder/spade connection,
4+PE-pos.

| | | Technical data | | | Technical data | | |
|---|--------------|--|-----------|-------------|--|-----------|-------------|
| General data | | | | | | | |
| Degree of protection | | IP68/IP69K | | | IP68/IP69K | | |
| Electrical data | | | | | | | |
| Rated voltage | | 60 V | | | 60 V | | |
| Rated surge voltage | | 6 kV | | | 6 kV | | |
| Surge voltage category/pollution degree | | III/3 | | | III/3 | | |
| Material data | | | | | | | |
| Housing material | | PA | | | PA | | |
| Contact material | | Cu | | | Cu | | |
| Inflammability class according to UL 94 | | V0 | | | V0 | | |
| Mechanical data | | | | | | | |
| Impact category | | IK07 | | | IK07 | | |
| Color | | Black | | | Black | | |
| Connector data QUICKON connection | | | | | | | |
| Core insulation | | PVC/PE/TPE/rubber | | | PVC/PE/TPE/rubber | | |
| Structure of individual litz wire/ smallest wire diameter | | VDE 0295 class 1 to 6/min. 0.15 mm | | | VDE 0295 class 1 to 6/min. 0.15 mm | | |
| Connection frequency | | max. 10 | | | max. 10 | | |
| Conductor cross section [mm ²] solid/stranded | | 1 mm ² ... 2.5 mm ² /1 mm ² ... 2.5 mm ² | | | 1 mm ² ... 2.5 mm ² /1 mm ² ... 2.5 mm ² | | |
| Conductor cross section [AWG] | | 16 ... 14 | | | 16 ... 14 | | |
| Temperature data | | | | | | | |
| Ambient temperature (operation) | | -40°C ... 80°C | | | -40°C ... 80°C | | |
| Temperature when conductor connected | | -5°C ... 50°C | | | -5°C ... 50°C | | |
| | | Ordering data | | | Ordering data | | |
| Description | Cable length | Type | Order No. | Pcs. / Pkt. | Type | Order No. | Pcs. / Pkt. |
| Panel feed-through, with M20 x 1.5 mounting flange, with QUICKON nut, for cable diameter: | | | | | | | |
| 6 mm ... 11 mm | 0.5 m | QPD W 4PE2,5 6-11 M20 0,5 EX | 1411393 | 1 | | | |
| 6 mm ... 11 mm | 1 m | QPD W 4PE2,5 6-11 M20 1,0 EX | 1411394 | 1 | | | |
| 6 mm ... 11 mm | | | | | QPD W 4PE2,5 6-11 M20 FC EX | 1411395 | 1 |
| 9 mm ... 16 mm | 0.5 m | QPD W 4PE2,5 9-16 M20 0,5 EX | 1411397 | 1 | | | |
| 9 mm ... 16 mm | 1 m | QPD W 4PE2,5 9-16 M20 1,0 EX | 1411398 | 1 | | | |
| 9 mm ... 16 mm | | | | | QPD W 4PE2,5 9-16 M20 FC EX | 1411399 | 1 |
| Panel feed-through, with M25 x 1.5 mounting flange, with QUICKON nut, for cable diameters: | | | | | | | |
| 6 mm ... 11 mm | 0.5 m | QPD W 4PE2,5 6-11 M25 0,5 EX | 1411387 | 1 | | | |
| 6 mm ... 11 mm | 1 m | QPD W 4PE2,5 6-11 M25 1,0 EX | 1411388 | 1 | | | |
| 6 mm ... 11 mm | | | | | QPD W 4PE2,5 6-11 M25 FC EX | 1411389 | 1 |
| 9 mm ... 16 mm | 0.5 m | QPD W 4PE2,5 9-16 M25 0,5 EX | 1411390 | 1 | | | |
| 9 mm ... 16 mm | 1 m | QPD W 4PE2,5 9-16 M25 1,0 EX | 1411391 | 1 | | | |
| 9 mm ... 16 mm | | | | | QPD W 4PE2,5 9-16 M25 FC EX | 1411392 | 1 |

Panel feed-throughs, 6.0 mm²

- Devices no longer need to be opened in order to connect the cables
- User-friendly connection, even on devices that are difficult to access
- Touch-proof in accordance with DIN EN 50274



With one QUICKON nut,
4+PE-pos.



Without QUICKON nut,
4+PE-pos.

| | Technical data | | Technical data | | |
|--|--|--|--|--|-------------|
| | Black | Gray | Black | Gray | |
| General data | | | | | |
| Degree of protection | IP68/IP69K | IP68/IP69K | IP68/IP69K | IP68/IP69K | |
| Electrical data | | | | | |
| Rated voltage (III/3) | 690 V | 690 V | 690 V | 690 V | |
| Rated surge voltage | 6 kV | 6 kV | 6 kV | 6 kV | |
| Rated current | 40 A | 40 A | 40 A | 40 A | |
| Surge voltage category/pollution degree | III/3 | III/3 | III/3 | III/3 | |
| Material data | | | | | |
| Housing material | PA | PA | PA | PA | |
| Contact material | Cu | Cu | Cu | Cu | |
| Inflammability class according to UL 94 | V0 | V0 | V0 | V0 | |
| Mechanical data | | | | | |
| Impact category | IK07 | IK07 | IK07 | IK07 | |
| Color | Black | Gray | Black | Gray | |
| Connector data QUICKON connection | | | | | |
| Core insulation | PVC/PE/TPE/rubber | PVC/PE/TPE/rubber | PVC/PE/TPE/rubber | PVC/PE/TPE/rubber | |
| Structure of individual litz wire/ smallest wire diameter | VDE 0295 class 1 to 6/ min. 0.15 mm | VDE 0295 class 1 to 6/ min. 0.15 mm | VDE 0295 class 1 to 6/ min. 0.15 mm | VDE 0295 class 1 to 6/ min. 0.15 mm | |
| Connection frequency | max. 10 | max. 10 | max. 10 | max. 10 | |
| Conductor cross section [mm ²] solid/stranded | 2.5 mm ² ... 6 mm ² / 2.5 mm ² ... 6 mm ² | 2.5 mm ² ... 6 mm ² / 2.5 mm ² ... 6 mm ² | 2.5 mm ² ... 6 mm ² / 2.5 mm ² ... 6 mm ² | 2.5 mm ² ... 6 mm ² / 2.5 mm ² ... 6 mm ² | |
| Conductor cross section [AWG] | 14 ... 10 | 14 ... 10 | 14 ... 10 | 14 ... 10 | |
| Temperature data | | | | | |
| Ambient temperature (operation) | -40°C ... 80°C | -40°C ... 80°C | -40°C ... 80°C | -40°C ... 80°C | |
| Temperature when conductor connected | -5°C ... 50°C | -5°C ... 50°C | -5°C ... 50°C | -5°C ... 50°C | |
| | Ordering data | | Ordering data | | |
| Description | Cable length | Order No. | Pcs. / Pkt. | Order No. | Pcs. / Pkt. |
| | | Black | | Gray | |
| Panel feed-through, with M25 x 1.5 mounting flange, with one QUICKON nut, for cable diameter: | | | | | |
| 9 mm ... 14 mm | 0.5 m | 1410392 | 1 | 1410399 | 1 |
| 9 mm ... 14 mm | 1 m | 1410393 | 1 | 1410400 | 1 |
| 12 mm ... 20 mm | 0.5 m | 1410394 | 1 | 1410401 | 1 |
| 12 mm ... 20 mm | 1 m | 1410395 | 1 | 1410402 | 1 |
| Panel feed-through, with M25 x 1.5 mounting flange, without QUICKON nut | | | | | |
| | 0.5 m | | | 1410396 | 1 |
| | 1 m | | | 1410397 | 1 |
| QUICKON nut, for connections up to 6.0 mm², for cable diameter: | | | | | |
| 9 mm ... 14 mm | | | | 1410409 | 1 |
| 12 mm ... 20 mm | | | | 1410406 | 1 |
| | | | | 1410403 | 1 |
| | | | | 1410404 | 1 |
| | | | | 1410407 | 1 |
| | | | | 1410405 | 1 |

Installation system - QPD installation system

Assembled cables, 2.5 mm²

- Connecting cable between two QUICKON connections
- User-friendly connection, even on devices that are difficult to access
- Touch-proof in accordance with DIN EN 50274
- Other versions available on request



4+PE-pos.

| Technical data | |
|---|--|
| General data | |
| Degree of protection | IP68/IP69K |
| Electrical data | |
| Rated voltage (III/3) | 690 V |
| Rated surge voltage | 6 kV |
| Rated current | 20 A |
| Surge voltage category/pollution degree | III/3 |
| Material data | |
| Housing material | PA |
| Contact material | Cu |
| Inflammability class according to UL 94 | V0 |
| Mechanical data | |
| Impact category | IK07 |
| Color | Black |
| Connector data QUICKON connection | |
| Core insulation | PVC/PE/TPE/rubber |
| Structure of individual litz wire/ smallest wire diameter | VDE 0295 class 1 to 6/min. 0.15 mm |
| Connection frequency | max. 10 |
| Conductor cross section [mm ²] solid/stranded | 1 mm ² ... 2.5 mm ² /1 mm ² ... 2.5 mm ² |
| Conductor cross section [AWG] | 16 ... 14 |
| Temperature data | |
| Ambient temperature (operation) | -40°C ... 80°C |
| Temperature when conductor connected | -5°C ... 50°C |

| Ordering data | | | | |
|------------------------|--------------|-----------------------------|-----------|-------------|
| Description | Cable length | Type | Order No. | Pcs. / Pkt. |
| Assembled cable | 1 m | QPD 5P/ 1,0-PVC/5P 5X2,5 BK | 1408720 | 1 |
| | 3 m | QPD 5P/ 3,0-PVC/5P 5X2,5 BK | 1408721 | 1 |
| | 5 m | QPD 5P/ 5,0-PVC/5P 5X2,5 BK | 1408722 | 1 |
| | 10 m | QPD 5P/10,0-PVC/5P 5X2,5 BK | 1408723 | 1 |

Accessories



- Mounting clip ① for easily fixing the H-distributor in place without the need for tools
- DIN rail mounting can be achieved using two DIN-rail adapters ②
- Plastic labels ③ can be stuck to the middle of the H-distributor
- Red sealing plugs ④ can be easily stuck into the QUICKON nuts and create a seal when screwed tight
- Protective caps with retaining cords ⑤ for closing open QUICKON domes which are going to have a connector (for example) fitted at a later date
- Locking nuts ⑥ for fixing the panel feed-throughs to thin panels that are unable to accommodate a proprietary thread
- Insulating sleeve ⑦ for 4.8 mm slip-on connections
- Transparent protective caps ⑧ for attaching to the open QUICKON dome
- Transparent protective caps ⑨ at front for attaching to the connector
- Slotted socket wrenches ⑩ enable you to tighten the QUICKON nuts easily and securely
- Red coding profiles ⑪ for preventing QPD connector mix-ups. Simply insert them into the QUICKON dome and connector on the front side. They are marked with an arrow and their symmetrical form enables them to be mounted in four different positions
- AS-Interface seals ⑫ for connecting 1 or 2 AS-Interface cables
- Aluminum shielding tape ⑬ prevents the splicing of the braided shield and enables a clean shield connection









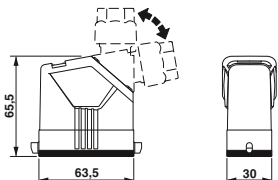

| Description | | Ordering data | | |
|-------------|---|------------------------------|--------------------|-------------|
| | | Type | Order No. | Pcs. / Pkt. |
| | Mounting clip , for the 4-pos. H-distributor, color: black ① | QPD CLIP 2,5 BK | 1582235 | 10 |
| | DIN rail adapter For M5 screws ② | USA 10/4,6 | 1202713 | 10 |
| | Plastic label For plotting and engraving Can be printed using thermal transfer printer ③ | GPE 13X 9 WH EMLP (13X9)R | 0806932 0819453 | 10 1 |
| | Closing cap , for closing unused bore holes in multiple seals and cable glands ④ | | | |
| | Ø 10 mm | SEALING PLUG 10X16 RD | 1400284 | 10 |
| | Ø 14 mm | SEALING PLUG 14X22 RD | 1400270 | 10 |
| | Protective cap , captive, IP68 ⑤ | | | |
| | Color: green | QPD QSK 2,5 FS | 1582488 | 1 |
| | Color: black | QPD QSK BK 2,5 FS | 1582645 | 1 |
| | Color: gray | QPD QSK GY 5X2,5 FS | 1404526 | 1 |
| | Color: black | QPD QSK BK 5X2,5 FS | 1404525 | 1 |
| | Counter nut , (plastic), to lock the contact carrier from the inside of the device ⑥ | | | |
| | M16 / SW22 / color: green | Q-MU M16 | 1640692 | 25 |
| | M20 / SW26 / color: green | Q-MU M20 | 1640702 | 25 |
| | M25 / SW32 / color: black | Q-MU M25 | 1640715 | 25 |
| | Pg21 / SW36 / color: black | Q-MU PG 21 BK | 1582655 | 50 |
| | Insulating sleeve , as shock protection for 4.8 mm slip-on sleeves; first slide over the conductor ⑦ | | | |
| | For 4.8 mm slip-on sleeves | PT/FS 4,8 | 1670497 | 25 |
| | Protective cap , transparent plastic, for QUICKON connection, IP54 ⑧ | | | |
| | | QPD QSK 2,5 | 1582150 | 10 |
| | | QPD QSK 5X2,5 | 1404528 | 10 |
| | | QPD QSK 5X6,0 | 1411403 | 10 |
| | Protective cap , transparent plastic, for QUICKON connection, IP50 ⑨ | | | |
| | | QPD PSK 2,5 | 1582151 | 10 |
| | | QPD PSK 5X2,5 | 1404529 | 10 |
| | | QPD PSK 5X6,0 | 1411404 | 10 |
| | Slotted socket wrench for QUICKON nuts and panel feed-throughs, for wrench size: ⑩ | | | |
| | 15 mm | QSS 15 | 1641992 | 1 |
| | 19 mm | QSS 19 | 1670895 | 1 |
| | 22 mm | QSS 22 | 1670206 | 1 |
| | 24 mm | QSS 24 | 1670219 | 1 |
| | 27 mm | QSS 27 | 1670646 | 1 |
| | Coding profile , for insertion into the connector and QUICKON dome ⑪ | | | |
| | | CP-QPD | 1582459 | 10 |
| | | CP-QPD 5X2,5 | 1404530 | 10 |
| | Seal for 4-pos. versions , NBR, black, for IP65/IP67 protection ⑫ | | | |
| | One AS-i cable | KV-DI-PG16-1XASI | 1582462 | 10 |
| | Two AS-i cables | KV-DI-PG16-2XASI | 1582464 | 10 |
| | Shielding tape , aluminum, for the shielded QPD versions ⑬ | | | |
| | | ALU-SB | 1404531 | 100 |

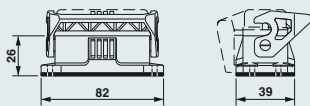
Heavy-duty connectors - HEAVYCON type D

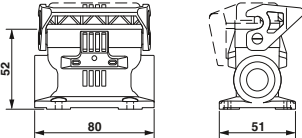
EVO housing, type D15, plastic, single locking latch

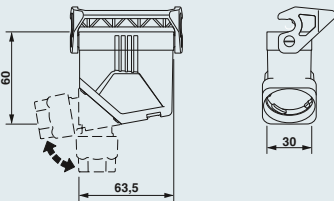

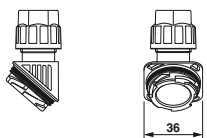
| General data | | Technical data | |
|--------------------------------------|--|-----------------|--|
| Housing material | | Polyamide | |
| Locking latch material | | Polyamide | |
| Sealing material | | NBR | |
| Ambient temperature (operation) | | -40°C ... 100°C | |
| Type of protection (when plugged in) | | IP66 | |

| Description | | Thread | Type | Order No. | Pcs. / Pkt. | Dimensions |
|--|--|------------------|--|--------------------|-------------|---|
| Sleeve housing Height: 65.5 mm  | | | HC-EVO-D15-HHFS-PL-BK | 1411340 | 1 |  |
| Panel mounting base Height: 26 mm  | | | Without cover HC-EVO-D15-BWS-PLR-BK With cover HC-EVO-D15-BWSC-PLR-BK | 1411336 1411337 | 1 1 |  |
| Box mounting base Height: 52 mm  | | 2x M25 2x M25 | Without cover HC-EVO-D15-SLWS-2SSM25-PLR-BK With cover HC-EVO-D15-SLWSC-2SSM25-PLR-BK | 1411341 1411343 | 1 1 |  |
| Coupling housing Height: 60 mm  | | | HC-EVO-D15-CHWS-PL-BK | 1411338 | 1 |  |
| Cable gland  | | 1x M20 1x M25 | HC-D-G-M20-PLRBK HC-D-G-M25-PLRBK | 1411350 1411351 | 1 1 |  |
| Connector set  | | | Without cover, screw connection HC-EVO-A10UT-BWS-HH-M20-PLRBK With cover, screw connection HC-EVO-A10UT-BWSC-HH-M20-PLRBK | 1411356 1411357 | 1 1 | |

Accessories



Thread adapter
From page 219









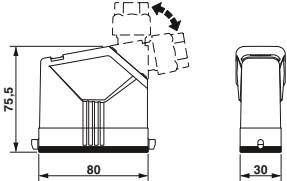

**EVO housing, type D25,
plastic, single locking latch**

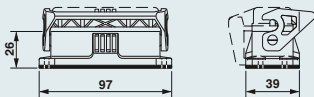

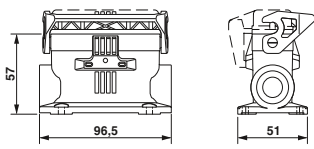
Technical data

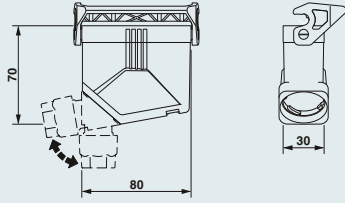
| General data | |
|--------------------------------------|-----------------|
| Housing material | Polyamide |
| Locking latch material | Polyamide |
| Sealing material | NBR |
| Ambient temperature (operation) | -40°C ... 100°C |
| Type of protection (when plugged in) | IP66 |

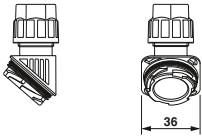
Ordering data

| Description | Thread | Type | Order No. | Pcs. / Pkt. | Dimensions |
|--|--------|--|-----------|-------------|---|
| Sleeve housing Height: 75.5 mm  | | HC-EVO-D25-HHFS-PL-BK | 1411347 | 1 |  |
| Panel mounting base Height: 26 mm  | | Without cover HC-EVO-D25-BWS-PLR-BK | 1411344 | 1 |  |
| | | With cover HC-EVO-D25-BWSC-PLR-BK | 1411345 | 1 | |
| Box mounting base Height: 57 mm  | 2x M25 | Without cover HC-EVO-D25-SLWS-2SSM25-PLR-BK | 1411348 | 1 |  |
| | 2x M25 | With cover HC-EVO-D25-SLWSC-2SSM25-PLR-BK | 1411349 | 1 | |
| Coupling housing Height: 70 mm  | | HC-EVO-D25-CHWS-PLR-BK | 1411346 | 1 |  |
| Cable gland  | 1x M20 | HC-D-G-M20-PLRBK | 1411350 | 1 |  |
| | 1x M25 | HC-D-G-M25-PLRBK | 1411351 | 1 | |
| Connector set  | | Without cover, screw connection HC-EVO-A16UT-BWS-HH-M25-PLRBK | 1411358 | 1 | |
| | | With cover, screw connection HC-EVO-A16UT-BWSC-HH-M25-PLRBK | 1411359 | 1 | |

Accessories



Thread adapter
From page 219

Heavy-duty connectors - HEAVYCON type B

Contact inserts BB series

500 V, 16 A

Connection technology:

- Crimp connection

With groove for accommodating coding profiles for easy and inexpensive coding of identical plug-in connections

- Can be coded in seconds, thanks to the coding profile



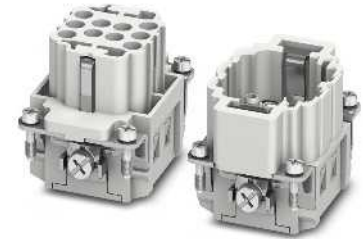



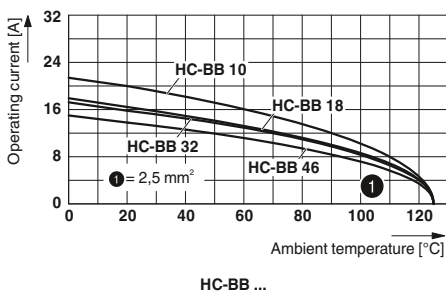

| Notes: |
|--|
| For accessories, see Catalog 4 from page 552 |
| Order crimp contacts separately |
| Connectors may only be operated when under no load |
| Observe notes on the connection technology |

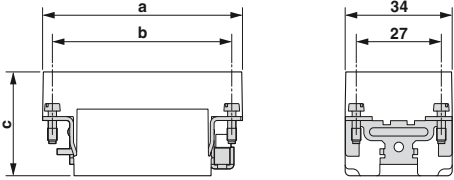

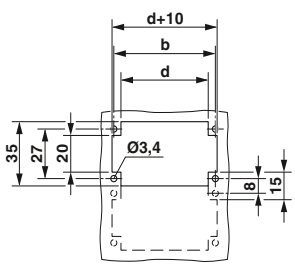
| Type | Technical data | | | |
|---|-------------------|-----------------------|-----------------------|-----------------------|
| | HC-BB 10-I-CT-... | HC-BB 18-I-CT-... | HC-BB 32-I-CT-... | HC-BB 46-I-CT-... |
| Approvals | - | - | - | - |
| IEC data | | | | |
| Rated current, contacts (at 40°C) | A | 16 | 16 | 16 |
| Surge voltage category | | III | III | III |
| Pollution degree | | 3 | 3 | 3 |
| Rated voltage (III/3) contacts | V | 500 | 500 | 500 |
| Rated surge voltage, contacts | kV | 6 | 6 | 6 |
| Connection cross section | mm ² | 0.5 ... 4 | 0.5 ... 4 | 0.5 ... 4 |
| UL data | | | | |
| Rated voltage | V | - | - | - |
| Rated current | A | - | - | - |
| AWG | | - | - | - |
| CSA data | | | | |
| Rated voltage | V | - | - | - |
| Rated current | A | - | - | - |
| AWG | | - | - | - |
| Material data | | | | |
| Contact carrier material | | PC | PC | PC |
| Inflammability class in acc. with UL 94 | | V0 | V0 | V0 |
| Contact material | | Copper alloy | Copper alloy | Copper alloy |
| Contact surface material | | Ag (alternatively Au) | Ag (alternatively Au) | Ag (alternatively Au) |
| Temperature data | | | | |
| Ambient temperature range | °C | -40 ... 125 | -40 ... 125 | -40 ... 125 |
| General data | | | | |
| Connection method | | Crimp connection | Crimp connection | Crimp connection |
| No. of pos. | | 10 | 18 | 32 |
| Contact numbering | | 1 - 10 | 1 - 18 | 1 - 32 |
| Insertion/withdrawal cycles | | ≥ 500 | ≥ 500 | ≥ 500 |

Derating curves



| Description | Pos. | Number | Housing | Ordering data | | | Pcs. / Pkt. | Dimensions (in mm) | | | | | | | | | | | | | | | | | | | | | | | | | | | | | | | | | | | | | | | | | | | | | | | | | | | | | | | | | | | | | | | | | |
|---|------|---------|-------------------------------------|---------------------------|------------------|----------------|-------------|--|--|---|---|---|---|----------|----|----|------|--|--------|--|--|------|----|----------|----|----|------|--|--------|--|--|------|----|----------|------|------|------|--|--------|--|--|------|------|----------|------|------|------|--|--------|--|--|------|------|----------|-----|-----|------|--|--------|--|--|------|----|----------|-----|-----|------|--|--------|--|--|------|----|
| | | | | Type | Order No. Socket | Order No. Plug | | | | | | | | | | | | | | | | | | | | | | | | | | | | | | | | | | | | | | | | | | | | | | | | | | | | | | | | | | | | | | | | | | | |
| Crimp connection  | 10 | 1 - 10 | B6 | ① HC-BB 10-I-CT-... | 1584703 | 1584774 | 1 |  | | | | | | | | | | | | | | | | | | | | | | | | | | | | | | | | | | | | | | | | | | | | | | | | | | | | | | | | | | | | | | | | | |
| Crimp connection  | 18 | 1 - 18 | B10 | ② HC-BB 18-I-CT-... | 1584729 | 1584716 | 1 | | | | | | | | | | | | | | | | | | | | | | | | | | | | | | | | | | | | | | | | | | | | | | | | | | | | | | | | | | | | | | | | | | |
| Crimp connection  | 32 | 1 - 32 | B16 / B32 | ③ HC-BB 32-I-CT-... | 1584745 | 1584732 | 1 |  <p>Dimensional drawing</p> <p>Panel cutout</p> | | | | | | | | | | | | | | | | | | | | | | | | | | | | | | | | | | | | | | | | | | | | | | | | | | | | | | | | | | | | | | | | | |
| Crimp connection  | 32 | 33 - 64 | B16 / B32 | ④ HC-BB 32-I-CT-... 33-64 | 1406543 | 1406544 | 1 | | | | | | | | | | | | | | | | | | | | | | | | | | | | | | | | | | | | | | | | | | | | | | | | | | | | | | | | | | | | | | | | | | |
| Crimp connection  | 46 | 1 - 46 | B24 / B48 | ⑤ HC-BB 46-I-CT-... | 1584758 | 1584761 | 1 | <table border="1"> <thead> <tr> <th></th> <th>a</th> <th>b</th> <th>c</th> <th>d</th> </tr> </thead> <tbody> <tr> <td>① Socket</td> <td>51</td> <td>44</td> <td>32.5</td> <td></td> </tr> <tr> <td>① Plug</td> <td></td> <td></td> <td>33.2</td> <td>35</td> </tr> <tr> <td>② Socket</td> <td>64</td> <td>57</td> <td>32.5</td> <td></td> </tr> <tr> <td>② Plug</td> <td></td> <td></td> <td>33.2</td> <td>48</td> </tr> <tr> <td>③ Socket</td> <td>84.5</td> <td>77.5</td> <td>32.5</td> <td></td> </tr> <tr> <td>③ Plug</td> <td></td> <td></td> <td>33.2</td> <td>68.5</td> </tr> <tr> <td>④ Socket</td> <td>84.5</td> <td>77.5</td> <td>32.5</td> <td></td> </tr> <tr> <td>④ Plug</td> <td></td> <td></td> <td>33.2</td> <td>68.5</td> </tr> <tr> <td>⑤ Socket</td> <td>111</td> <td>104</td> <td>32.5</td> <td></td> </tr> <tr> <td>⑤ Plug</td> <td></td> <td></td> <td>33.2</td> <td>95</td> </tr> <tr> <td>⑥ Socket</td> <td>111</td> <td>104</td> <td>32.5</td> <td></td> </tr> <tr> <td>⑥ Plug</td> <td></td> <td></td> <td>33.2</td> <td>95</td> </tr> </tbody> </table> | | a | b | c | d | ① Socket | 51 | 44 | 32.5 | | ① Plug | | | 33.2 | 35 | ② Socket | 64 | 57 | 32.5 | | ② Plug | | | 33.2 | 48 | ③ Socket | 84.5 | 77.5 | 32.5 | | ③ Plug | | | 33.2 | 68.5 | ④ Socket | 84.5 | 77.5 | 32.5 | | ④ Plug | | | 33.2 | 68.5 | ⑤ Socket | 111 | 104 | 32.5 | | ⑤ Plug | | | 33.2 | 95 | ⑥ Socket | 111 | 104 | 32.5 | | ⑥ Plug | | | 33.2 | 95 |
| | a | b | c | d | | | | | | | | | | | | | | | | | | | | | | | | | | | | | | | | | | | | | | | | | | | | | | | | | | | | | | | | | | | | | | | | | | | | | |
| ① Socket | 51 | 44 | 32.5 | | | | | | | | | | | | | | | | | | | | | | | | | | | | | | | | | | | | | | | | | | | | | | | | | | | | | | | | | | | | | | | | | | | | | | |
| ① Plug | | | 33.2 | 35 | | | | | | | | | | | | | | | | | | | | | | | | | | | | | | | | | | | | | | | | | | | | | | | | | | | | | | | | | | | | | | | | | | | | | |
| ② Socket | 64 | 57 | 32.5 | | | | | | | | | | | | | | | | | | | | | | | | | | | | | | | | | | | | | | | | | | | | | | | | | | | | | | | | | | | | | | | | | | | | | | |
| ② Plug | | | 33.2 | 48 | | | | | | | | | | | | | | | | | | | | | | | | | | | | | | | | | | | | | | | | | | | | | | | | | | | | | | | | | | | | | | | | | | | | | |
| ③ Socket | 84.5 | 77.5 | 32.5 | | | | | | | | | | | | | | | | | | | | | | | | | | | | | | | | | | | | | | | | | | | | | | | | | | | | | | | | | | | | | | | | | | | | | | |
| ③ Plug | | | 33.2 | 68.5 | | | | | | | | | | | | | | | | | | | | | | | | | | | | | | | | | | | | | | | | | | | | | | | | | | | | | | | | | | | | | | | | | | | | | |
| ④ Socket | 84.5 | 77.5 | 32.5 | | | | | | | | | | | | | | | | | | | | | | | | | | | | | | | | | | | | | | | | | | | | | | | | | | | | | | | | | | | | | | | | | | | | | | |
| ④ Plug | | | 33.2 | 68.5 | | | | | | | | | | | | | | | | | | | | | | | | | | | | | | | | | | | | | | | | | | | | | | | | | | | | | | | | | | | | | | | | | | | | | |
| ⑤ Socket | 111 | 104 | 32.5 | | | | | | | | | | | | | | | | | | | | | | | | | | | | | | | | | | | | | | | | | | | | | | | | | | | | | | | | | | | | | | | | | | | | | | |
| ⑤ Plug | | | 33.2 | 95 | | | | | | | | | | | | | | | | | | | | | | | | | | | | | | | | | | | | | | | | | | | | | | | | | | | | | | | | | | | | | | | | | | | | | |
| ⑥ Socket | 111 | 104 | 32.5 | | | | | | | | | | | | | | | | | | | | | | | | | | | | | | | | | | | | | | | | | | | | | | | | | | | | | | | | | | | | | | | | | | | | | | |
| ⑥ Plug | | | 33.2 | 95 | | | | | | | | | | | | | | | | | | | | | | | | | | | | | | | | | | | | | | | | | | | | | | | | | | | | | | | | | | | | | | | | | | | | | |
| Crimp connection  | 46 | 47 - 92 | B24 / B48 | ⑥ HC-BB 46-I-CT-... 47-92 | 1406545 | 1406546 | 1 | | | | | | | | | | | | | | | | | | | | | | | | | | | | | | | | | | | | | | | | | | | | | | | | | | | | | | | | | | | | | | | | | | |
| Turned crimp contacts CK 2,5 Silver-plated  | | | | | | | | | | | | | | | | | | | | | | | | | | | | | | | | | | | | | | | | | | | | | | | | | | | | | | | | | | | | | | | | | | | | | | | | | |
| | | | Cross section mm ² / AWG | | | | | | | | | | | | | | | | | | | | | | | | | | | | | | | | | | | | | | | | | | | | | | | | | | | | | | | | | | | | | | | | | | | | | | |
| | | | 0.5 / 20 | CK2,5-ED-0,50... AG | 1663640 | 1663572 | 100 | | | | | | | | | | | | | | | | | | | | | | | | | | | | | | | | | | | | | | | | | | | | | | | | | | | | | | | | | | | | | | | | | | |
| | | | 0.75 / 18 | CK2,5-ED-0,75... AG | 1663653 | 1663585 | 100 | | | | | | | | | | | | | | | | | | | | | | | | | | | | | | | | | | | | | | | | | | | | | | | | | | | | | | | | | | | | | | | | | | |
| | | | 0.75 - 1 / 18 | CK2,5-ED-1,00... AG | 1663666 | 1663598 | 100 | | | | | | | | | | | | | | | | | | | | | | | | | | | | | | | | | | | | | | | | | | | | | | | | | | | | | | | | | | | | | | | | | | |
| | | | 1.5 / 16 | CK2,5-ED-1,50... AG | 1663679 | 1663608 | 100 | | | | | | | | | | | | | | | | | | | | | | | | | | | | | | | | | | | | | | | | | | | | | | | | | | | | | | | | | | | | | | | | | | |
| | | | 2.5 / 14 | CK2,5-ED-2,50... AG | 1663682 | 1663611 | 100 | | | | | | | | | | | | | | | | | | | | | | | | | | | | | | | | | | | | | | | | | | | | | | | | | | | | | | | | | | | | | | | | | | |
| | | | 4 / 12 | CK2,5-ED-4,00... AG | 1663705 | 1663637 | 100 | | | | | | | | | | | | | | | | | | | | | | | | | | | | | | | | | | | | | | | | | | | | | | | | | | | | | | | | | | | | | | | | | | |
| Turned crimp contacts CK 2,5 Gold-plated  | | | | | | | | | | | | | | | | | | | | | | | | | | | | | | | | | | | | | | | | | | | | | | | | | | | | | | | | | | | | | | | | | | | | | | | | | |
| | | | Cross section mm ² / AWG | | | | | | | | | | | | | | | | | | | | | | | | | | | | | | | | | | | | | | | | | | | | | | | | | | | | | | | | | | | | | | | | | | | | | | |
| | | | 0.5 / 20 | CK2,5-ED-0,50... AU | 1674859 | 1674804 | 100 | | | | | | | | | | | | | | | | | | | | | | | | | | | | | | | | | | | | | | | | | | | | | | | | | | | | | | | | | | | | | | | | | | |
| | | | 0.75 - 1 / 18 | CK2,5-ED-1,00... AU | 1674833 | 1674781 | 100 | | | | | | | | | | | | | | | | | | | | | | | | | | | | | | | | | | | | | | | | | | | | | | | | | | | | | | | | | | | | | | | | | | |
| | | | 1.5 / 16 | CK2,5-ED-1,50... AU | 1674820 | 1674778 | 100 | | | | | | | | | | | | | | | | | | | | | | | | | | | | | | | | | | | | | | | | | | | | | | | | | | | | | | | | | | | | | | | | | | |
| | | | 2.5 / 14 | CK2,5-ED-2,50... AU | 1674862 | 1674817 | 100 | | | | | | | | | | | | | | | | | | | | | | | | | | | | | | | | | | | | | | | | | | | | | | | | | | | | | | | | | | | | | | | | | | |
| | | | 4 / 12 | CK2,5-ED-4,00... AU | 1674846 | 1674794 | 100 | | | | | | | | | | | | | | | | | | | | | | | | | | | | | | | | | | | | | | | | | | | | | | | | | | | | | | | | | | | | | | | | | | |

Accessories



Coding profiles
From page 221



PE screws
Catalog 4 from page 580



Crimping tools
Catalog 4 from page 562

Heavy-duty connectors - HEAVYCON type B

Contact inserts

HS series, high-current applications

500 V, 35 A

Connection technology:

– Screw connection

With groove for accommodating coding profiles for easy and inexpensive coding of identical plug-in connections

– Can be coded in seconds, thanks to the coding profile

| Notes: |
|--|
| For accessories, see Catalog 4 from page 552 |
| Connectors may only be operated when under no load |
| Observe notes on the connection technology |



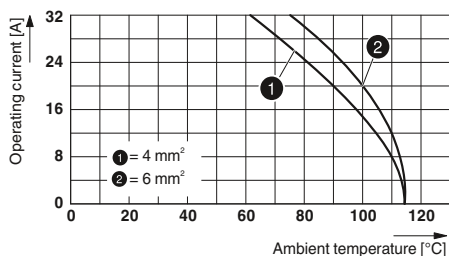

| Type | Technical data | | |
|---|------------------|-----------------------|------------------|
| | HC-HS06-I-UT-... | HC-HS06-I-UT-... 7-12 | |
| Approvals | - | - | |
| IEC data | | | |
| Rated current, contacts (at 40°C) | A | 35 | 35 |
| Surge voltage category | | III | III |
| Pollution degree | | 3 | 3 |
| Rated voltage (III/3) contacts | V | 400/690 | 400/690 |
| Rated surge voltage, contacts | kV | 6 | 6 |
| Connection cross section | mm ² | 0.5 ... 6 | 0.5 ... 6 |
| UL data | | | |
| Rated voltage | V | - | - |
| Rated current | A | - | - |
| AWG | | - | - |
| CSA data | | | |
| Rated voltage | V | - | - |
| Rated current | A | - | - |
| AWG | | - | - |
| Material data | | | |
| Contact carrier material | | PC | PC |
| Inflammability class in acc. with UL 94 | | V0 | V0 |
| Contact material | | Copper alloy | Copper alloy |
| Contact surface material | | Ag | Ag |
| Temperature data | | | |
| Ambient temperature range | °C | -40 ... 125 | -40 ... 125 |
| General data | | | |
| Connection method | | Screw connection | Screw connection |
| No. of pos. | | 6 | 6 |
| Contact numbering | | 1 - 6 | 7 - 12 |
| Insertion/withdrawal cycles | | ≥ 500 | ≥ 500 |

Derating curves

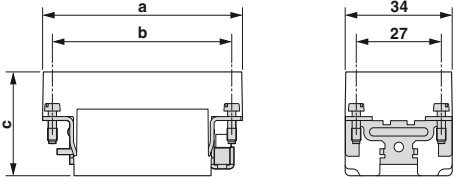

HC-HS06-I-UT-...

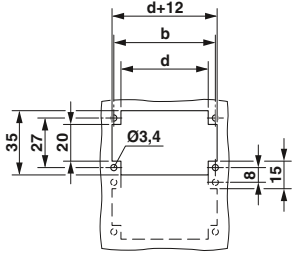
| Description | Pos. | Number | Housing | Ordering data | | | Pcs. / Pkt. | Dimensions (in mm) | | | | | | | | | | | | | | | | | | | | | | | | | |
|--|------|--------|-----------|-------------------------|------------------|----------------|-------------|--|--|---|---|---|---|----------|------|------|----|----|--------|------|------|----|----|----------|------|------|----|----|--------|------|------|----|----|
| | | | | Type | Order No. Socket | Order No. Plug | | | | | | | | | | | | | | | | | | | | | | | | | | | |
| Screw connection  | 6 | 1 - 6 | B16 / B32 | ① HC-HS06-I-UT-... | 1406530 | 1406531 | 1 |  | | | | | | | | | | | | | | | | | | | | | | | | | |
| Screw connection  | 6 | 7 - 12 | B16 / B32 | ② HC-HS06-I-UT-... 7-12 | 1406533 | 1406534 | 1 | Dimensional drawing  Panel cutout | | | | | | | | | | | | | | | | | | | | | | | | | |
| | | | | | | | | <table border="1"> <thead> <tr> <th></th> <th>a</th> <th>b</th> <th>c</th> <th>d</th> </tr> </thead> <tbody> <tr> <td>① Socket</td> <td>84.5</td> <td>77.5</td> <td>34</td> <td>72</td> </tr> <tr> <td>① Plug</td> <td>84.5</td> <td>77.5</td> <td>34</td> <td>72</td> </tr> <tr> <td>② Socket</td> <td>84.5</td> <td>77.5</td> <td>34</td> <td>72</td> </tr> <tr> <td>② Plug</td> <td>84.5</td> <td>77.5</td> <td>34</td> <td>72</td> </tr> </tbody> </table> | | a | b | c | d | ① Socket | 84.5 | 77.5 | 34 | 72 | ① Plug | 84.5 | 77.5 | 34 | 72 | ② Socket | 84.5 | 77.5 | 34 | 72 | ② Plug | 84.5 | 77.5 | 34 | 72 |
| | a | b | c | d | | | | | | | | | | | | | | | | | | | | | | | | | | | | | |
| ① Socket | 84.5 | 77.5 | 34 | 72 | | | | | | | | | | | | | | | | | | | | | | | | | | | | | |
| ① Plug | 84.5 | 77.5 | 34 | 72 | | | | | | | | | | | | | | | | | | | | | | | | | | | | | |
| ② Socket | 84.5 | 77.5 | 34 | 72 | | | | | | | | | | | | | | | | | | | | | | | | | | | | | |
| ② Plug | 84.5 | 77.5 | 34 | 72 | | | | | | | | | | | | | | | | | | | | | | | | | | | | | |
| | | | | | | | | | | | | | | | | | | | | | | | | | | | | | | | | | |

Accessories



Coding profiles
Catalog 4 from page 581



PE screws
Catalog 4 from page 580



EMC protection

The new EMC series of HEAVYCON EVO heavy-duty connectors has been specifically developed for applications with increased requirements. Furthermore, the housing surfaces and all seals are constructed so as to be electrically conductive.

Flexible, thanks to reduced number of versions

Thanks to the unique HEAVYCON EVO bayonet locking, only the swivel cable glands have to be replaced in order to cover the M20, M25, M32, and M40 clamping areas with straight and lateral outlet.

Fully compatible

The HEAVYCON EVO housing is plug-compatible with standard aluminum housing. It fits the standard panel cutouts of heavy-duty connectors.



Easy closing operation

The bayonet locking designed specially for EVO applications ensures easy on-site assembly without tools. For removal, a standard screwdriver is used to push down on the locking spring.

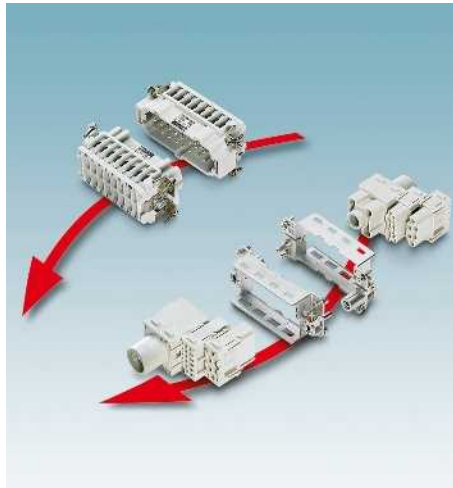

Suitable for all inserts

All fixed and modular contact inserts in B series format fit in HEAVYCON EVO housing.



Electrical connection

A solid electrical connection is required between the housing and the cable gland for EMC and safety reasons. The locking spring ensures a safe mechanical and electrical connection.



Complete panel feed-through

The new EMC housings combine the advantages of EVO plastic housing with those of standard metal housing. A complete panel feed-through system is therefore available for EMC applications.



Easy cable assembly

On the HEAVYCON EVO housing, the angled cable inlet is particularly large. This simplifies cable assembly if the cable gland is only mounted at the end of the process.



For harsh conditions

The metal housings are made from salt-water-resistant aluminum. They meet the requirements of IP66 protection and NEMA 4/4x/12.

Heavy-duty connectors - HEAVYCON type B

EVO housing, type B6, metal, for EMC applications, single locking latch









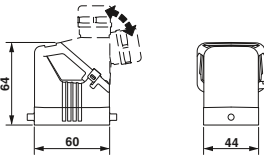

General data

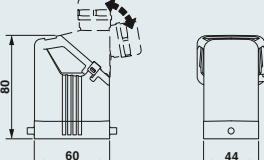
Housing material
Surface material
Locking latch material
Sealing material
Ambient temperature (operation)
Type of protection (when plugged in)

| Technical data | |
|--------------------------------------|---|
| Housing material | Die-cast aluminum, salt water resistant |
| Surface material | Uncoated |
| Locking latch material | Polyamide |
| Sealing material | NBR, conductive |
| Ambient temperature (operation) | -40°C ... 125°C |
| Type of protection (when plugged in) | IP66 |

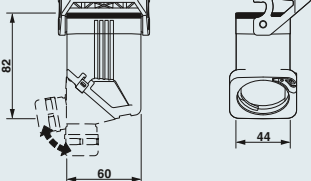
Ordering data

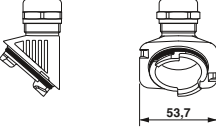
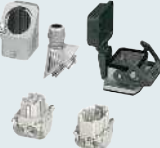
| Description | Thread | Type | Order No. | Pcs. / Pkt. | Dimensions |
|--|--------------------------------------|--|--|------------------|---|
| Sleeve housing Height: 64 mm  | | HC-EVO-B06-HLFS-EL-AL | 1411448 | 1 |  |
| Sleeve housing Height: 80 mm  | | HC-EVO-B06-HHFS-EL-AL | 1411447 | 1 |  |
| Panel mounting base Height: 30.5 mm  | | Without cover HC-STA-B06-BWS-ELC-AL With cover HC-STA-B06-BWSC-ELC-AL | 1411318 1411319 | 1 1 |  |
| Coupling housing Height: 82 mm  | | HC-EVO-B06-CHWS-ELC-AL | 1411450 | 1 |  |
| Cable gland  | 1x M20 1x M25 1x M32 1x M40 | HC-B-G-M20-EC-AL HC-B-G-M25-EC-AL HC-B-G-M32-EC-AL HC-B-G-M40-EC-AL | 1411439 1411446 1411440 1411441 | 1 1 1 1 |  |
| Connector set  | | Push-in connection HC-EVO-B06PT-BWSC-HL-M20ELC-AL | 1411487 | 1 | |

Accessories











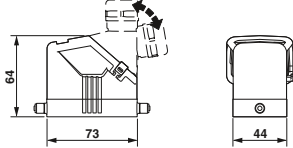

Replacement seals
From page 220

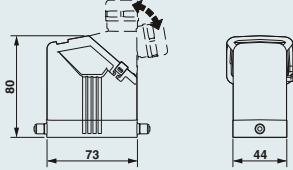
EVO housing, type B10, metal, for EMC applications, single locking latch

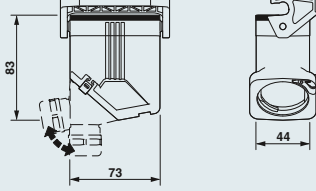

| Technical data | |
|--------------------------------------|---|
| General data | |
| Housing material | Die-cast aluminum, salt water resistant |
| Surface material | Uncoated |
| Locking latch material | Polyamide |
| Sealing material | NBR, conductive |
| Ambient temperature (operation) | -40°C ... 125°C |
| Type of protection (when plugged in) | IP66 |

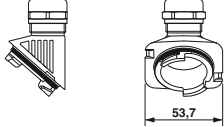
Ordering data

| Description | Thread | Type | Order No. | Pcs. / Pkt. | Dimensions |
|---|--------------------------------------|--|--|------------------|---|
| Sleeve housing Height: 64 mm  | | HC-EVO-B10-HLFS-EL-AL | 1411456 | 1 |  |
| Sleeve housing Height: 80 mm  | | HC-EVO-B10-HHFS-EL-AL | 1411453 | 1 |  |
| Panel mounting base Height: 30.5 mm  | | Without cover HC-STA-B10-BWS-ELC-AL With cover HC-STA-B10-BWSC-ELC-AL | 1411320 1411321 | 1 1 |  |
| Coupling housing Height: 83 mm  | | HC-EVO-B10-CHWS-ELC-AL | 1411459 | 1 |  |
| Cable gland  | 1x M20 1x M25 1x M32 1x M40 | HC-B-G-M20-EC-AL HC-B-G-M25-EC-AL HC-B-G-M32-EC-AL HC-B-G-M40-EC-AL | 1411439 1411446 1411440 1411441 | 1 1 1 1 |  |
| Connector set  | | Push-in connection HC-EVO-B10PT-BWSC-HL-M25ELC-AL | 1411491 | 1 | |

Accessories



Replacement seals
From page 220

Heavy-duty connectors - HEAVYCON type B

EVO housing, type B10, metal, for EMC applications, double locking latch









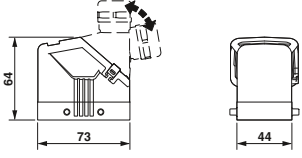

General data

Housing material
Surface material
Locking latch material
Sealing material
Ambient temperature (operation)
Type of protection (when plugged in)

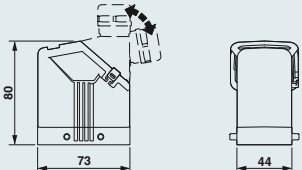
Technical data

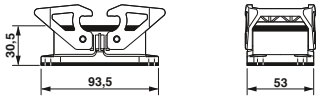
Die-cast aluminum, salt water resistant
Uncoated
Polyamide
NBR, conductive
-40°C ... 125°C
IP66

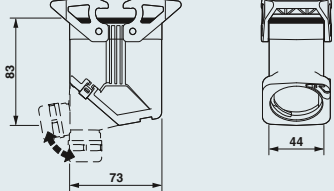
Ordering data

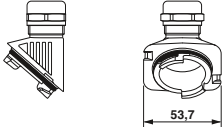
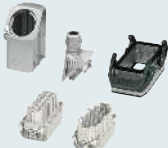
| Description | Thread | Type | Order No. | Pcs. / Pkt. | Dimensions |
|--|--------------------------------------|--|--|------------------|---|
| Sleeve housing Height: 64 mm  | | HC-EVO-B10-HLFD-EL-AL | 1411455 | 1 |  |
| Sleeve housing Height: 80 mm  | | HC-EVO-B10-HHFD-EL-AL | 1411451 | 1 |  |
| Panel mounting base Height: 30.5 mm  | | Without cover HC-STA-B10-BWD-ELC-AL | 1411322 | 1 |  |
| Coupling housing Height: 83 mm  | | HC-EVO-B10-CHWD-ELC-AL | 1411458 | 1 |  |
| Cable gland  | 1x M20 1x M25 1x M32 1x M40 | HC-B-G-M20-EC-AL HC-B-G-M25-EC-AL HC-B-G-M32-EC-AL HC-B-G-M40-EC-AL | 1411439 1411446 1411440 1411441 | 1 1 1 1 |  |
| Connector set  | | Push-in connection HC-EVO-B10PT-BWD-HL-M25ELC-AL | 1411488 | 1 | |

Accessories



Replacement seals
From page 220

EVO housing, type B10, metal, for EMC applications, double locking latch



Technical data

General data

Housing material
Surface material
Locking latch material
Sealing material
Ambient temperature (operation)
Type of protection (when plugged in)

Die-cast aluminum, salt water resistant
Uncoated
Polyamide
NBR, conductive
-40°C ... 125°C
IP66

Ordering data

| Description | Thread | Type | Order No. | Pcs. / Pkt. | Dimensions |
|--|--|--|--|----------------------------|------------|
| <p>Sleeve housing Height: 64 mm</p> | | HC-EVO-B10-HLWD-EL-AL | 1411457 | 1 | |
| <p>Sleeve housing Height: 80 mm</p> | | HC-EVO-B10-HHWD-EL-AL | 1411454 | 1 | |
| <p>Panel mounting base Height: 30.5 mm</p> | | With cover HC-STA-B10-BFDC-ELC-AL | 1411323 | 1 | |
| <p>Cable gland</p> | <p>1x M20 1x M25 1x M32 1x M40</p> | <p>HC-B-G-M20-EC-AL HC-B-G-M25-EC-AL HC-B-G-M32-EC-AL HC-B-G-M40-EC-AL</p> | <p>1411439 1411446 1411440 1411441</p> | <p>1 1 1 1</p> | |

Accessories



Replacement seals
From page 220

Heavy-duty connectors - HEAVYCON type B

EVO housing, type B16, metal, for EMC applications, single locking latch









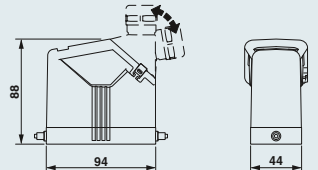

Technical data

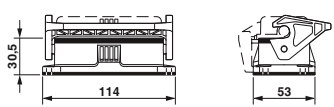
General data

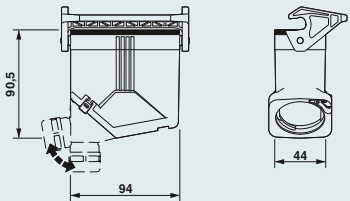
| | |
|--------------------------------------|---|
| Housing material | Die-cast aluminum, salt water resistant |
| Surface material | Uncoated |
| Locking latch material | Polyamide |
| Sealing material | NBR, conductive |
| Ambient temperature (operation) | -40°C ... 125°C |
| Type of protection (when plugged in) | IP66 |

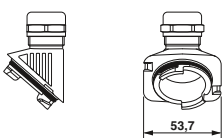
Ordering data

| Description | Thread | Type | Order No. | Pcs. / Pkt. | Dimensions |
|--|--------------------------------------|--|--|------------------|---|
| Sleeve housing Height: 88 mm  | | HC-EVO-B16-HHFS-EL-AL | 1411461 | 1 |  |
| Panel mounting base Height: 30.5 mm  | | Without cover HC-STA-B16-BWS-ELC-AL With cover HC-STA-B16-BWSC-ELC-AL | 1411324 1411325 | 1 1 |  |
| Coupling housing Height: 90.5 mm  | | HC-EVO-B16-CHWS-ELC-AL | 1411464 | 1 |  |
| Cable gland  | 1x M20 1x M25 1x M32 1x M40 | HC-B-G-M20-EC-AL HC-B-G-M25-EC-AL HC-B-G-M32-EC-AL HC-B-G-M40-EC-AL | 1411439 1411446 1411440 1411441 | 1 1 1 1 |  |
| Connector set  | | Push-in connection HC-EVO-B16PT-BWSC-HH-M25ELC-AL | 1411492 | 1 | |

Accessories



Replacement seals
From page 220

EVO housing, type B16, metal, for EMC applications, double locking latch









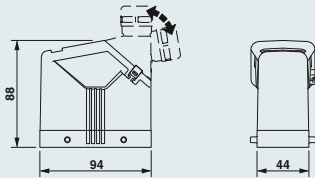

Technical data

General data

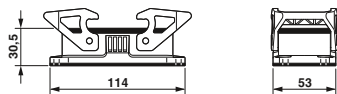
Housing material
Surface material
Locking latch material
Sealing material
Ambient temperature (operation)
Type of protection (when plugged in)

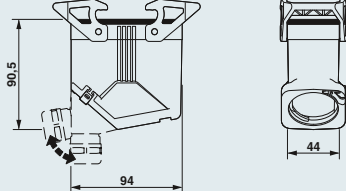
Die-cast aluminum, salt water resistant
Uncoated
Polyamide
NBR, conductive
-40°C ... 125°C
IP66

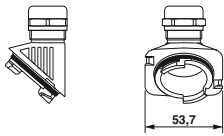
Ordering data

| Description | Thread | Type | Order No. | Pcs. / Pkt. | Dimensions |
|---|--------------------------------------|--|--|------------------|---|
| <p>Sleeve housing Height: 88 mm</p>  | | HC-EVO-B16-HHFD-EL-AL | 1411460 | 1 |  |
| <p>Panel mounting base Height: 30.5 mm</p>  | | Without cover HC-STA-B16-BWD-ELC-AL | 1411327 | 1 |  |
| <p>Coupling housing Height: 90.5 mm</p>  | | HC-EVO-B16-CHWD-ELC-AL | 1411463 | 1 |  |
| <p>Cable gland</p>  | 1x M20 1x M25 1x M32 1x M40 | HC-B-G-M20-EC-AL HC-B-G-M25-EC-AL HC-B-G-M32-EC-AL HC-B-G-M40-EC-AL | 1411439 1411446 1411440 1411441 | 1 1 1 1 |  |
| <p>Connector set</p>  | | Push-in connection HC-EVO-B16PT-BWD-HH-M25ELC-AL | 1411489 | 1 | |

Accessories



Replacement seals
From page 220

Heavy-duty connectors - HEAVYCON type B

EVO housing, type B16, metal, for EMC applications, double locking latch







Technical data

General data

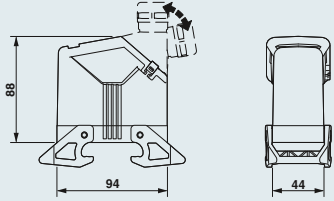
| | |
|--------------------------------------|---|
| Housing material | Die-cast aluminum, salt water resistant |
| Surface material | Uncoated |
| Locking latch material | Polyamide |
| Sealing material | NBR, conductive |
| Ambient temperature (operation) | -40°C ... 125°C |
| Type of protection (when plugged in) | IP66 |

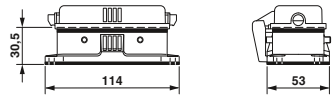
Ordering data

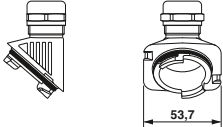
| Description | Thread | Type | Order No. | Pcs. / Pkt. | Dimensions |
|--|--------------------------------------|--|--|------------------|---|
| Sleeve housing Height: 88 mm  | | HC-EVO-B16-HHWD-EL-AL | 1411462 | 1 |  |
| Panel mounting base Height: 30.5 mm  | | With cover HC-STA-B16-BFDC-ELC-AL | 1411328 | 1 |  |
| Cable gland  | 1x M20 1x M25 1x M32 1x M40 | HC-B-G-M20-EC-AL HC-B-G-M25-EC-AL HC-B-G-M32-EC-AL HC-B-G-M40-EC-AL | 1411439 1411446 1411440 1411441 | 1 1 1 1 |  |

Accessories



Replacement seals
From page 220

EVO housing, type B24, metal, for EMC applications, single locking latch









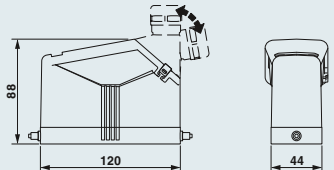

Technical data

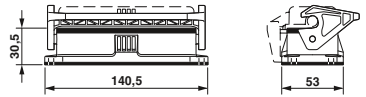
General data

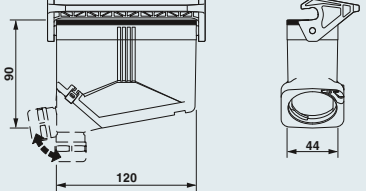
| | |
|--------------------------------------|---|
| Housing material | Die-cast aluminum, salt water resistant |
| Surface material | Uncoated |
| Locking latch material | Polyamide |
| Sealing material | NBR, conductive |
| Ambient temperature (operation) | -40°C ... 125°C |
| Type of protection (when plugged in) | IP66 |

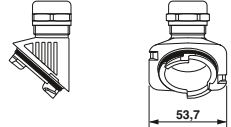
Ordering data

| Description | Thread | Type | Order No. | Pcs. / Pkt. | Dimensions |
|---|--------------------------------------|--|--|------------------|---|
| Sleeve housing Height: 88 mm  | | HC-EVO-B24-HHFS-EL-AL | 1411473 | 1 |  |
| Panel mounting base Height: 30.5 mm  | | Without cover HC-STA-B24-BWS-ELC-AL With cover HC-STA-B24-BWSC-ELC-AL | 1411329 1411330 | 1 1 |  |
| Coupling housing Height: 90 mm  | | HC-EVO-B24-CHWS-ELC-AL | 1411476 | 1 |  |
| Cable gland  | 1x M20 1x M25 1x M32 1x M40 | HC-B-G-M20-EC-AL HC-B-G-M25-EC-AL HC-B-G-M32-EC-AL HC-B-G-M40-EC-AL | 1411439 1411446 1411440 1411441 | 1 1 1 1 |  |
| Connector set  | | Push-in connection HC-EVO-B24PT-BWSC-HH-M32ELC-AL | 1411493 | 1 | |

Accessories



Replacement seals
From page 220

Heavy-duty connectors - HEAVYCON type B

EVO housing, type B24, metal, for EMC applications, double locking latch









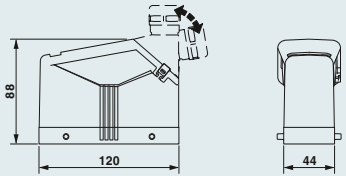

General data

Housing material
Surface material
Locking latch material
Sealing material
Ambient temperature (operation)
Type of protection (when plugged in)

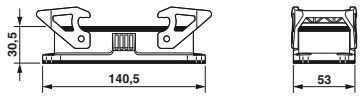
Technical data

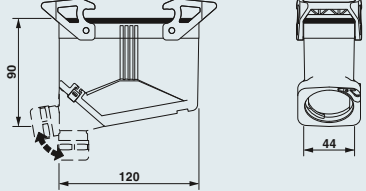
Die-cast aluminum, salt water resistant
Uncoated
Polyamide
NBR, conductive
-40°C ... 125°C
IP66

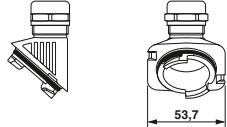
Ordering data

| Description | Thread | Type | Order No. | Pcs. / Pkt. | Dimensions |
|---|--------------------------------------|--|--|------------------|---|
| Sleeve housing Height: 88 mm  | | HC-EVO-B24-HHFD-EL-AL | 1411472 | 1 |  |
| Panel mounting base Height: 30.5 mm  | | Without cover HC-STA-B24-BWD-ELC-AL | 1411331 | 1 |  |
| Coupling housing Height: 90 mm  | | HC-EVO-B24-CHWD-ELC-AL | 1411475 | 1 |  |
| Cable gland  | 1x M20 1x M25 1x M32 1x M40 | HC-B-G-M20-EC-AL HC-B-G-M25-EC-AL HC-B-G-M32-EC-AL HC-B-G-M40-EC-AL | 1411439 1411446 1411440 1411441 | 1 1 1 1 |  |
| Connector set  | | Push-in connection HC-EVO-B24PT-BWD-HH-M32ELC-AL | 1411490 | 1 | |

Accessories



Replacement seals
From page 220

EVO housing, type B24, metal, for EMC applications, double locking latch







Technical data

General data

Housing material
Surface material
Locking latch material
Sealing material
Ambient temperature (operation)
Type of protection (when plugged in)

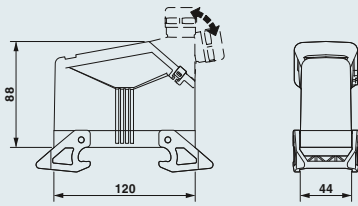
Die-cast aluminum, salt water resistant
Uncoated
Polyamide
NBR, conductive
-40°C ... 125°C
IP66

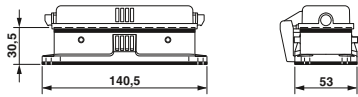
Ordering data

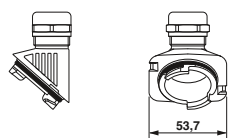
| Description | Thread | Type | Order No. | Pcs. / Pkt. | Dimensions |
|--|--|--|--|----------------------------|---|
| <p>Sleeve housing Height: 88 mm</p>  | | HC-EVO-B24-HHWD-EL-AL | 1411474 | 1 |  |
| <p>Panel mounting base Height: 30.5 mm</p>  | | With cover HC-STA-B24-BFDC-ELC-AL | 1411332 | 1 |  |
| <p>Cable gland</p>  | <p>1x M20 1x M25 1x M32 1x M40</p> | <p>HC-B-G-M20-EC-AL HC-B-G-M25-EC-AL HC-B-G-M32-EC-AL HC-B-G-M40-EC-AL</p> | <p>1411439 1411446 1411440 1411441</p> | <p>1 1 1 1</p> |  |

Accessories



Replacement seals
From page 220

Heavy-duty connectors - HEAVYCON type B

HPR housing, type B6, metal, for railway applications, screw locking









General data

Housing material
Surface material
Lock material
Sealing material
Ambient temperature (operation)
Type of protection (when plugged in)

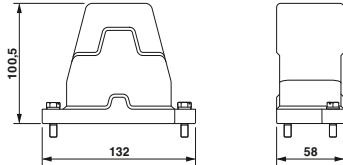
Technical data

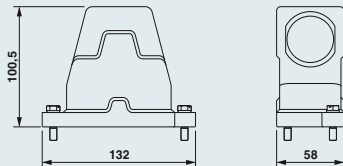
Aluminum die-cast
Powder-coated, black
High-grade steel
Silicon
-40°C ... 125°C
IP68/IP69K

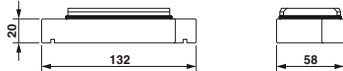
Ordering data

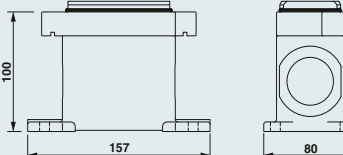
| Description | Thread | Type | Order No. | Pcs. / Pkt. | Dimensions |
|--|------------------|--|-----------|-------------|---|
| Sleeve housing Height: 100.5 mm  | 1x M20 1x M25 | Cable entry: top | 1411879 | 1 |  |
| | | HC-HPR-B06-HHWH-1TTM20-EM-BK HC-HPR-B06-HHWH-1TTM25-EM-BK | 1411106 | 1 | |
| Sleeve housing Height: 100.5 mm  | 1x M20 1x M25 | Cable entry: lateral | 1411878 | 1 |  |
| | | HC-HPR-B06-HHWH-1STM20-EM-BK HC-HPR-B06-HHWH-1STM25-EM-BK | 1411119 | 1 | |
| Panel mounting base Height: 20 mm  | | Without cover HC-HPR-B06-BFH-EMR-BK | 1411122 | 1 |  |
| Box mounting base Height: 100 mm  | 2x M20 2x M25 | Without cover | 1411880 | 1 |  |
| | | HC-HPR-B06-SHFH-2SSM20-EMR-BK HC-HPR-B06-SHFH-2SSM25-EMR-BK | 1411135 | 1 | |

Accessories



Cable gland
From page 229







HPR housing, type B10, metal, for railway applications, screw locking

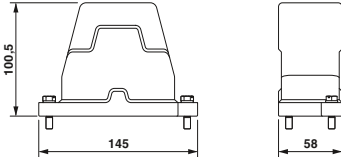

Technical data

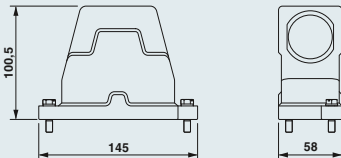
| | |
|--------------------------------------|----------------------|
| General data | |
| Housing material | Aluminum die-cast |
| Surface material | Powder-coated, black |
| Lock material | High-grade steel |
| Sealing material | Silicon |
| Ambient temperature (operation) | -40°C ... 125°C |
| Type of protection (when plugged in) | IP68/IP69K |

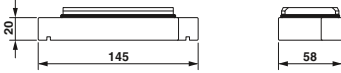
Ordering data

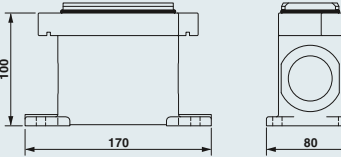
| Description | Thread | Type | Order No. | Pcs. / Pkt. | Dimensions |
|---|------------------|--|-----------|-------------|---|
| Sleeve housing Height: 100.5 mm  | 1x M25 1x M32 | Cable entry: top HC-HPR-B10-HHWH-1TTM25-EM-BK | 1411882 | 1 |  |
| | | HC-HPR-B10-HHWH-1TTM32-EM-BK | 1411067 | 1 | |
| Sleeve housing Height: 100.5 mm  | 1x M25 1x M32 | Cable entry: lateral HC-HPR-B10-HHWH-1STM25EM-BK | 1411881 | 1 |  |
| | | HC-HPR-B10-HHWH-1STM32-EM-BK | 1411070 | 1 | |
| Panel mounting base Height: 20 mm  | | Without cover HC-HPR-B10-BFH-EMR-BK | 1411083 | 1 |  |
| Box mounting base Height: 100 mm  | 2x M25 2x M32 | Without cover HC-HPR-B10-SHFH-2SSM25-EMR-BK | 1411883 | 1 |  |
| | | HC-HPR-B10-SHFH-2SSM32-EMR-BK | 1411096 | 1 | |

Accessories



Cable gland
From page 229

Heavy-duty connectors - HEAVYCON type B

HPR housing, type B16, metal, for railway applications, screw locking









General data

Housing material
Surface material
Lock material
Sealing material
Ambient temperature (operation)
Type of protection (when plugged in)

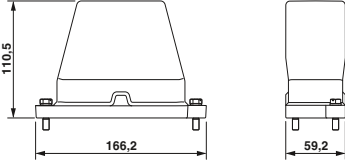
Technical data

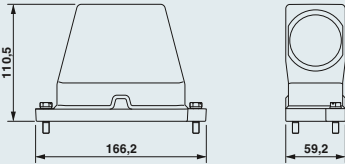
Aluminum die-cast
Powder-coated, black
High-grade steel
Silicon
-40°C ... 125°C
IP68/IP69K

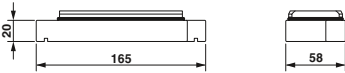
Ordering data

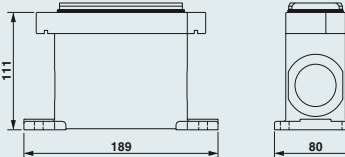
| Description | Thread | Type | Order No. | Pcs. / Pkt. | Dimensions |
|--|------------------|--|-----------|-------------|---|
| Sleeve housing Height: 110.5 mm  | 1x M32 1x M40 | Cable entry: top | 1411059 | 1 |  |
| | | HC-HPR-B16-HHWH-1TTM32-EM-BK HC-HPR-B16-HHWH-1TTM40-EM-BK | 1411885 | 1 | |
| Sleeve housing Height: 110.5 mm  | 1x M32 1x M40 | Cable entry: lateral | 1411058 | 1 |  |
| | | HC-HPR-B16-HHWH-1STM32-EM-BK HC-HPR-B16-HHWH-1STM40-EM-BK | 1411884 | 1 | |
| Panel mounting base Height: 20 mm  | | Without cover HC-HPR-B16-BFH-EMR-BK | 1411060 | 1 |  |
| Box mounting base Height: 111 mm  | 2x M32 2x M40 | Without cover | 1411054 | 1 |  |
| | | HC-HPR-B16-SHFH-2SSM32-EMR-BK HC-HPR-B16-SHFH-2SSM40-EMR-BK | 1411886 | 1 | |

Accessories



Cable gland
From page 229

HPR housing, type B24, metal, for railway applications, screw locking









Technical data

General data

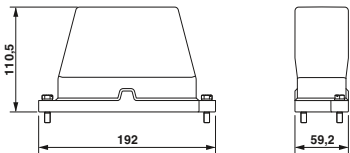
Housing material
Surface material
Lock material
Sealing material
Ambient temperature (operation)
Type of protection (when plugged in)

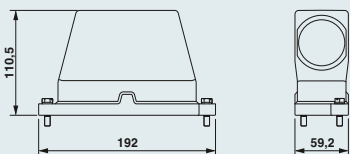
Aluminum die-cast
Powder-coated, black
High-grade steel
Silicon
-40°C ... 125°C
IP68/IP69K

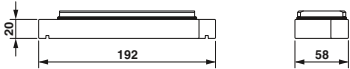
Ordering data

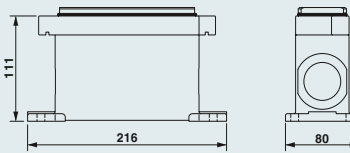
| Description | Thread | Type | Order No. | Pcs. / Pkt. | Dimensions |
|---|------------------|---|-----------|-------------|---|
| Sleeve housing Height: 110.5 mm  | 1x M32 1x M40 | Cable entry: top HC-HPR-B24-HHWH-1TTM32-EM-BK | 1411888 | 1 |  |
| | | HC-HPR-B24-HHWH-1TTM40-EM-BK | 1411062 | 1 | |
| Sleeve housing Height: 110.5 mm  | 1x M32 1x M40 | Cable entry: lateral HC-HPR-B24-HHWH-1STM32-EM-BK | 1411887 | 1 |  |
| | | HC-HPR-B24-HHWH-1STM40-EM-BK | 1411061 | 1 | |
| Panel mounting base Height: 20 mm  | | Without cover HC-HPR-B24-BFH-EMR-BK | 1411055 | 1 |  |
| Box mounting base Height: 111 mm  | 2x M32 2x M40 | Without cover HC-HPR-B24-SHFH-2SSM32-EMR-BK | 1411889 | 1 |  |
| | | HC-HPR-B24-SHFH-2SSM40-EMR-BK | 1411063 | 1 | |

Accessories



Cable gland
From page 229

Cable glands

Metal HEAVYCON EVO standard cable gland for higher strain relief with bayonet locking.

Black plastic cable glands with extended clamping area.

Notes:
Not for EMC applications



EVO standard cable gland, metal, with NBR seal



Cable gland, plastic

| | | Technical data | | | Technical data | | |
|--|-------------|---------------------|-----------|-------------|----------------------|-----------|-------------|
| Material data | | | | | | | |
| Material | | Aluminum, die-cast | | | - | | |
| Material, pressure screw | | Nickel-plated brass | | | Polyamide | | |
| Cable seal material | | CR/NBR | | | - | | |
| Degree of protection | | IP66 | | | IP68, to 5 bar | | |
| Temperature data | | | | | | | |
| Ambient temperature (operation) | | -40°C ... 125°C | | | -20°C ... 100°C | | |
| | | Ordering data | | | Ordering data | | |
| Description | Thread type | Type | Order No. | Pcs. / Pkt. | Type | Order No. | Pcs. / Pkt. |
| Metal standard cable gland , for HEAVYCON EVO metal housing, for cable diameter [mm]: | | | | | | | |
| 7 mm ... 13 mm | M20 | HC-B-G-M20-ER-AL | 1411442 | 1 | | | |
| 11 mm ... 16 mm | M25 | HC-B-G-M25-ER-AL | 1411443 | 1 | | | |
| 14 mm ... 21 mm | M32 | HC-B-G-M32-ER-AL | 1411444 | 1 | | | |
| 19 mm ... 27 mm | M40 | HC-B-G-M40-ER-AL | 1411445 | 1 | | | |
| Plastic cable gland , with extended clamping area, for cable diameter [mm]: | | | | | | | |
| 5 mm ... 13 mm | M20 | | | | HC-K-KV-M20(5-13)BK | 1411261 | 10 |
| 8 mm ... 17 mm | M25 | | | | HC-K-KV-M25(8-17)BK | 1411258 | 10 |
| 12 mm ... 21 mm | M32 | | | | HC-K-KV-M32(12-21)BK | 1407673 | 10 |
| 16 mm ... 28 mm | M40 | | | | HC-K-KV-M40(16-28)BK | 1407674 | 10 |

Thread adapters, filler plugs

These thread adapters enable the use of special cable glands and corrugated pipe connections with HEAVYCON EVO type D housings.

Filler plugs for sealing unused thread openings on box mounting bases.



EVO D thread adapter, plastic



Filler plug, plastic

| | | Technical data | | | Technical data | | |
|---|-------------|---------------------------------|-----------|-------------|---------------------------------|-----------|-------------|
| Material data | | | | | | | |
| Material | | Polyamide fiberglass reinforced | | | Polyamide fiberglass reinforced | | |
| Material, pressure screw | | - | | | - | | |
| Cable seal material | | - | | | - | | |
| Degree of protection | | IP66 | | | IP65 | | |
| Temperature data | | | | | | | |
| Ambient temperature (operation) | | -40°C ... 125°C | | | -20°C ... 80°C | | |
| | | Ordering data | | | Ordering data | | |
| Description | Thread type | Type | Order No. | Pcs. / Pkt. | Type | Order No. | Pcs. / Pkt. |
| Plastic thread adapter , for HEAVYCON EVO type D plastic housing | M25 | HC-D-TA-M25-PLRBK | 1411352 | 1 | | | |
| | Pg16 | HC-D-TA-PG16-PLR-BK | 1411353 | 1 | | | |
| | NPT3/4" | HC-D-TA-NPT-3/4-PLR-BK | 1411354 | 1 | | | |
| Plastic filler plug , for HEAVYCON base profiles | M25 | | | | HC-K-BS-M25 BK | 1411245 | 10 |
| | M32 | | | | HC-K-BS-M32-BK | 1410754 | 10 |
| | M40 | | | | HC-K-BS-M40-BK | 1410767 | 10 |

Heavy-duty connectors - HEAVYCON accessories

Replacement flat gaskets, profile gaskets for type B

– For EMC housing

Notes:
Bond the replacement profile gaskets to the housing.



Replacement EMC flat gasket, for EVO B panel mounting base



Replacement EMC profile gasket, for EVO B supporting base element

| | Technical data | | | Technical data | | |
|--|-----------------|-----------|-------------|-----------------|-----------|-------------|
| Material data | | | | | | |
| Material | NBR, conductive | | | NBR, conductive | | |
| Temperature data | | | | | | |
| Ambient temperature (operation) | -40°C ... 125°C | | | -40°C ... 125°C | | |
| | Ordering data | | | Ordering data | | |
| Description | Type | Order No. | Pcs. / Pkt. | Type | Order No. | Pcs. / Pkt. |
| Replacement flat seal , for HEAVYCON panel mounting base type: | | | | | | |
| B6 | HC-B06-SG-CBK | 1411483 | 10 | | | |
| B10 | HC-B10-SG-CBK | 1411484 | 10 | | | |
| B16 | HC-B16-SG-CBK | 1411485 | 10 | | | |
| B24 | HC-B24-SG-CBK | 1411486 | 10 | | | |
| Replacement profile gasket , for HEAVYCON EVO supporting base element type: | | | | | | |
| B6 | | | | HC-B06-SP-CBK | 1411477 | 10 |
| B10 | | | | HC-B10-SP-CBK | 1411479 | 10 |
| B16 | | | | HC-B16-SP-CBK | 1411480 | 10 |
| B24 | | | | HC-B24-SP-CBK | 1411482 | 10 |

Special flat gaskets, coding profiles

Special flat gaskets for type B panel mounting bases for uneven mounting surfaces.

Coding profile for new BB series contact inserts.

- For easy and inexpensive coding of identical plug-in connections
- Can be coded in seconds, thanks to the coding profile



Special flat gasket, for standard B panel mounting base



Coding profile

| | Technical data | | | Technical data | | |
|---|-----------------|-----------|-------------|-----------------|-----------|-------------|
| Material data | | | | | | |
| Material | EPDM/CR | | | PA | | |
| Temperature data | | | | | | |
| Ambient temperature (operation) | -40°C ... 125°C | | | -40°C ... 125°C | | |
| | Ordering data | | | Ordering data | | |
| Description | Type | Order No. | Pcs. / Pkt. | Type | Order No. | Pcs. / Pkt. |
| Special flat gasket , made from foam rubber for HEAVYCON panel mounting base type: | | | | | | |
| B6 | HC-B 6-FL-MDI | 1410929 | 10 | | | |
| B10 | HC-B 10-FL-MDI | 1410932 | 10 | | | |
| B16 | HC-B 16-FL-MDI | 1410945 | 10 | | | |
| B24 | HC-B 24-FL-MDI | 1410958 | 10 | | | |
| Coding profile , for new BB series contact inserts | | | | | | |
| | | | | CP-HC-S | 1410916 | 10 |

Installation and mounting material - CES cable entry system

Sealing frames with cone-shaped cable sleeves

- Pre-assembled sealing frames with 8 (B16) or 10 (B24) cone-shaped cable sleeves. Particularly suitable for cables that are assembled or wired in the control cabinet. Cables up to 11 mm in diameter can be fed through by cutting off the sleeves.
- IP65 when using cable binders and vertical mounting
 - Resistant to oil, fuels, and grease
 - Halogen-free



Sealing frames with cone-shaped cable sleeves and screw locking

General data

Material of frames
Material of cable sleeves
Degree of protection

Technical data

Polyamide
NBR
IP54 (DIN IEC 60529)/IP65 (when directly mounted on the housing panel (perpendicular mounting or underwall mounting) and using a 3.6 mm wide cable binder (e.g., Order No. 3240744))

Temperature range [°C] -40 ... 120

Ordering data

Description

Pre-assembled sealing frames with cone-shaped cable sleeves, for cables with a diameter of:

2 - 11 mm
2 - 11 mm

Type

Order No.

Pcs. / Pkt.

CES-B16-8XSRC-BK
CES-B24-10XSRC-BK

1411073
1411074

1
1

Accessories

Electrician's scissors, high cutting performance, thanks to micro-serrated cutting area, suitable for copper, aluminum, Kevlar fibers, and plastic, two-component non-slip soft-grip handles, ergonomic design, adjustable screw joint

M4 replacement locking screw, with 3 mm Allen screw head, for sealing frame with screw locking

Bit screwdriver, with 1/4" quick-action chuck, suitable for bits according to DIN 3126-C 6.3 and E 6.3/ISO 1173, magnetic

Screw bit, hexagonal, E6.3-1/4" drive, hardened, suitable for holder according to DIN 3126-F 6.3/ISO 1173, size: hex 3 x 50 mm

Size: hex 3 x 50 mm

CUTFOX-ES

1212621

1

CES-SFFS-H

0801728

10

SF-M BH

1212070

1

SF-BIT-HEX 3-50

1212647

5

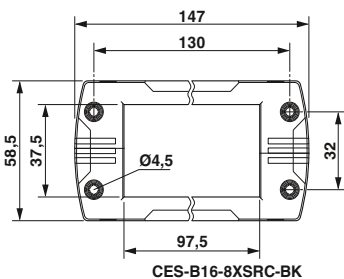

CES-B16-8XSRC-BK

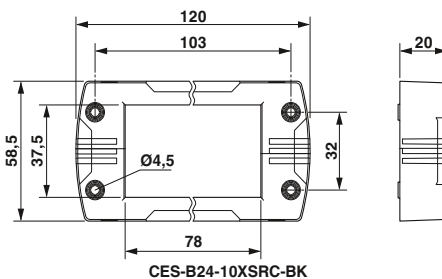

CES-B24-10XSRC-BK

Installation and mounting material - cable glands

Plastic cable gland, metric, EN 60423

- Material: polyamide 6
- Color: silver-gray (RAL 7001)
- Seal: neoprene
- Ambient temperature: -30°C ... +80°C (+150°C briefly)
- Degree of protection: IP68, 5 bar
- Strain relief: integrated according to EN 50262



Plastic cable gland



243143 / QCRV2.E320158 / 40024418

| Thread type | Clamping area [mm] | Dimensions [mm] | | | | | | |
|-------------|--------------------|-----------------|-------|-------|-------|-------|-------|---|
| | | a | b | c | d | e | f | g |
| M12 | 3.00 - 6.50 | 15.00 | 15.00 | 8.00 | 12.00 | 32.10 | 24.10 | - |
| M16 | 5.00 - 10.00 | 22.00 | 22.00 | 10.00 | 16.00 | 39.70 | 29.70 | - |
| M20 | 6.00 - 12.00 | 24.00 | 24.00 | 10.00 | 20.00 | 42.30 | 32.30 | - |
| M25 | 11.00 - 17.00 | 29.00 | 29.00 | 8.00 | 25.00 | 42.50 | 34.50 | - |
| M32 | 15.00 - 21.00 | 36.00 | 36.00 | 10.00 | 32.00 | 50.80 | 40.80 | - |
| M40 | 19.00 - 28.00 | 46.00 | 46.00 | 10.00 | 40.00 | 55.10 | 45.10 | - |
| M50 | 30.00 - 38.00 | 60.00 | 60.00 | 18.00 | 50.00 | 71.70 | 53.70 | - |
| M63 | 34.00 - 44.00 | 65.00 | 65.00 | 18.00 | 63.00 | 75.40 | 57.40 | - |

Ordering data

| Type | Order No. | Pcs. / Pkt. |
|------------------------|-----------|-------------|
| G-INS-M12-S68N-PNES-GY | 1411123 | 10 |
| G-INS-M16-S68N-PNES-GY | 1411124 | 10 |
| G-INS-M20-S68N-PNES-GY | 1411125 | 5 |
| G-INS-M25-M68N-PNES-GY | 1411126 | 5 |
| G-INS-M32-M68N-PNES-GY | 1411127 | 5 |
| G-INS-M40-M68N-PNES-GY | 1411128 | 5 |
| G-INS-M50-L68L-PNES-GY | 1411129 | 1 |
| G-INS-M63-L68L-PNES-GY | 1411130 | 1 |

Plastic counter nut, metric, EN 60423

- Material: polyamide 6
- Color: silver-gray (RAL 7001)
- Ambient temperature: -20°C ... +80°C

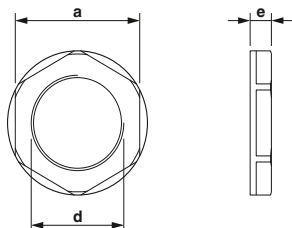

Plastic counter nut

| Thread type | Clamping area [mm] | Dimensions [mm] | | | | | | |
|-------------|--------------------|-----------------|---|---|-------|------|---|---|
| | | a | b | c | d | e | f | g |
| M12 | - | 18.00 | - | - | 12.00 | 5.00 | - | - |
| M16 | - | 22.00 | - | - | 16.00 | 5.00 | - | - |
| M20 | - | 26.00 | - | - | 20.00 | 6.00 | - | - |
| M25 | - | 32.00 | - | - | 25.00 | 6.00 | - | - |
| M32 | - | 41.00 | - | - | 32.00 | 7.00 | - | - |
| M40 | - | 50.00 | - | - | 40.00 | 7.00 | - | - |
| M50 | - | 60.00 | - | - | 50.00 | 8.00 | - | - |
| M63 | - | 75.00 | - | - | 63.00 | 8.00 | - | - |

Ordering data

| Type | Order No. | Pcs. / Pkt. |
|----------------|-----------|-------------|
| A-INL-M12-P-GY | 1411205 | 10 |
| A-INL-M16-P-GY | 1411206 | 10 |
| A-INL-M20-P-GY | 1411207 | 5 |
| A-INL-M25-P-GY | 1411208 | 5 |
| A-INL-M32-P-GY | 1411209 | 5 |
| A-INL-M40-P-GY | 1411210 | 5 |
| A-INL-M50-P-GY | 1411211 | 5 |
| A-INL-M63-P-GY | 1411212 | 5 |

**Plastic cable gland,
metric, EN 60423**

- Material: polyamide 6
- Color: deep black (RAL 9005)
- Seal: neoprene
- Ambient temperature:
-30°C ... +80°C (+150°C briefly)
- Degree of protection: IP68, 5 bar
- Strain relief: integrated according to EN 50262

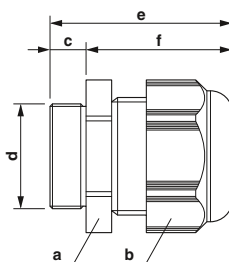

Plastic cable gland



243143 / QCRV.E320158 / 40024418

Ordering data

| Thread type | Clamping area [mm] | Dimensions [mm] | | | | | | |
|-------------|-----------------------|-----------------|-------|-------|-------|-------|-------|---|
| | | a | b | c | d | e | f | g |
| M12 | 3.00 - 6.50 | 15.00 | 15.00 | 8.00 | 12.00 | 32.10 | 24.10 | - |
| M16 | 5.00 - 10.00 | 22.00 | 22.00 | 10.00 | 16.00 | 39.70 | 29.70 | - |
| M20 | 6.00 - 12.00 | 24.00 | 24.00 | 10.00 | 20.00 | 42.30 | 32.30 | - |
| M25 | 11.00 - 17.00 | 29.00 | 29.00 | 8.00 | 25.00 | 42.50 | 34.50 | - |
| M32 | 15.00 - 21.00 | 36.00 | 36.00 | 10.00 | 32.00 | 50.80 | 40.80 | - |
| M40 | 19.00 - 28.00 | 46.00 | 46.00 | 10.00 | 40.00 | 55.10 | 45.10 | - |
| M50 | 30.00 - 38.00 | 60.00 | 60.00 | 18.00 | 50.00 | 71.70 | 53.70 | - |
| M63 | 34.00 - 44.00 | 65.00 | 65.00 | 18.00 | 63.00 | 75.40 | 57.40 | - |

| Type | Order No. | Pcs. / Pkt. |
|------------------------|-----------|-------------|
| G-INS-M12-S68N-PNES-BK | 1411131 | 10 |
| G-INS-M16-S68N-PNES-BK | 1411132 | 10 |
| G-INS-M20-S68N-PNES-BK | 1411133 | 5 |
| G-INS-M25-M68N-PNES-BK | 1411134 | 5 |
| G-INS-M32-M68N-PNES-BK | 1411136 | 5 |
| G-INS-M40-M68N-PNES-BK | 1411137 | 5 |
| G-INS-M50-L68L-PNES-BK | 1411138 | 1 |
| G-INS-M63-L68L-PNES-BK | 1411139 | 1 |

**Plastic counter nut,
metric, EN 60423**

- Material: polyamide 6
- Color: deep black (RAL 9005)
- Ambient temperature:
-20°C ... +80°C

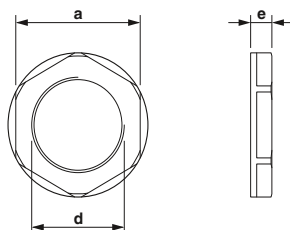

Plastic counter nut

| Thread type | Clamping area [mm] | Dimensions [mm] | | | | | | |
|-------------|-----------------------|-----------------|---|---|-------|------|---|---|
| | | a | b | c | d | e | f | g |
| M12 | - | 18.00 | - | - | 12.00 | 5.00 | - | - |
| M16 | - | 22.00 | - | - | 16.00 | 5.00 | - | - |
| M20 | - | 26.00 | - | - | 20.00 | 6.00 | - | - |
| M25 | - | 32.00 | - | - | 25.00 | 6.00 | - | - |
| M32 | - | 41.00 | - | - | 32.00 | 7.00 | - | - |
| M40 | - | 50.00 | - | - | 40.00 | 7.00 | - | - |
| M50 | - | 60.00 | - | - | 50.00 | 8.00 | - | - |
| M63 | - | 75.00 | - | - | 63.00 | 8.00 | - | - |

Ordering data

| Type | Order No. | Pcs. / Pkt. |
|----------------|-----------|-------------|
| A-INL-M12-P-BK | 1411213 | 10 |
| A-INL-M16-P-BK | 1411214 | 10 |
| A-INL-M20-P-BK | 1411215 | 5 |
| A-INL-M25-P-BK | 1411216 | 5 |
| A-INL-M32-P-BK | 1411217 | 5 |
| A-INL-M40-P-BK | 1411218 | 5 |
| A-INL-M50-P-BK | 1411219 | 5 |
| A-INL-M63-P-BK | 1411220 | 5 |

Installation and mounting material - cable glands

Plastic cable gland, Pg, EN 40430

- Material: polyamide 6
- Color: silver-gray (RAL 7001)
- Seal: neoprene
- Ambient temperature: -30°C ... +80°C (+150°C briefly)
- Degree of protection: IP68, 5 bar
- Strain relief: integrated according to EN 50262



Plastic cable gland



243143 / QCRV2.E320158

Ordering data

| Thread type | Clamping area [mm] | Dimensions [mm] | | | | | | |
|-------------|--------------------|-----------------|-------|-------|-------|-------|-------|---|
| | | a | b | c | d | e | f | g |
| Pg7 | 3.00 - 6.50 | 15.00 | 15.00 | 8.00 | 12.50 | 32.70 | 24.70 | - |
| Pg9 | 4.00 - 8.00 | 19.00 | 19.00 | 8.00 | 15.20 | 36.20 | 28.20 | - |
| Pg11 | 5.00 - 10.00 | 22.00 | 22.00 | 8.00 | 18.60 | 38.10 | 30.10 | - |
| Pg13.5 | 6.00 - 12.00 | 24.00 | 24.00 | 9.00 | 20.40 | 40.00 | 31.00 | - |
| Pg16 | 10.00 - 14.00 | 27.00 | 27.00 | 10.00 | 22.50 | 44.20 | 34.20 | - |
| Pg21 | 13.00 - 18.00 | 33.00 | 33.00 | 11.00 | 28.30 | 49.30 | 38.30 | - |
| Pg29 | 18.00 - 25.00 | 42.00 | 42.00 | 11.00 | 37.00 | 53.90 | 42.90 | - |
| Pg36 | 22.00 - 32.00 | 53.00 | 53.00 | 13.00 | 47.00 | 65.40 | 52.40 | - |
| Pg42 | 30.00 - 38.00 | 60.00 | 60.00 | 13.00 | 54.00 | 65.90 | 52.90 | - |
| Pg48 | 34.00 - 44.00 | 65.00 | 65.00 | 14.00 | 59.30 | 68.80 | 54.80 | - |

| Type | Order No. | Pcs. / Pkt. |
|---------------------------|-----------|-------------|
| G-INS-PG7-S68N-PNES-GY | 1411140 | 10 |
| G-INS-PG9-S68N-PNES-GY | 1411141 | 10 |
| G-INS-PG11-S68N-PNES-GY | 1411142 | 5 |
| G-INS-PG13,5-S68N-PNES-GY | 1411143 | 5 |
| G-INS-PG16-S68N-PNES-GY | 1411144 | 5 |
| G-INS-PG21-M68N-PNES-GY | 1411145 | 5 |
| G-INS-PG29-M68N-PNES-GY | 1411146 | 5 |
| G-INS-PG36-L68N-PNES-GY | 1411147 | 5 |
| G-INS-PG42-L68N-PNES-GY | 1411149 | 1 |
| G-INS-PG48-L68N-PNES-GY | 1411150 | 1 |

Plastic counter nut, Pg, EN 40430

- Material: polyamide 6
- Color: silver-gray (RAL 7001)
- Ambient temperature: -20°C ... +80°C

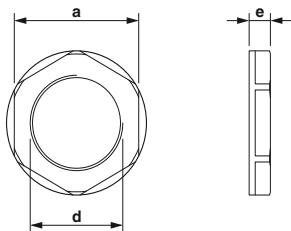

Plastic counter nut

Ordering data

| Thread type | Clamping area [mm] | Dimensions [mm] | | | | | | |
|-------------|--------------------|-----------------|---|---|-------|------|---|---|
| | | a | b | c | d | e | f | g |
| Pg7 | - | 19.00 | - | - | 12.50 | 5.00 | - | - |
| Pg9 | - | 22.00 | - | - | 15.20 | 5.00 | - | - |
| Pg11 | - | 24.00 | - | - | 18.60 | 5.00 | - | - |
| Pg13.5 | - | 27.00 | - | - | 20.40 | 6.00 | - | - |
| Pg16 | - | 30.00 | - | - | 22.50 | 6.00 | - | - |
| Pg21 | - | 36.00 | - | - | 28.30 | 7.00 | - | - |
| Pg29 | - | 46.00 | - | - | 37.00 | 7.00 | - | - |
| Pg36 | - | 60.00 | - | - | 47.00 | 8.00 | - | - |
| Pg42 | - | 65.00 | - | - | 54.00 | 8.00 | - | - |
| Pg48 | - | 70.00 | - | - | 59.30 | 8.00 | - | - |

| Type | Order No. | Pcs. / Pkt. |
|-------------------|-----------|-------------|
| A-INL-PG7-P-GY | 1411221 | 10 |
| A-INL-PG9-P-GY | 1411222 | 10 |
| A-INL-PG11-P-GY | 1411223 | 5 |
| A-INL-PG13,5-P-GY | 1411224 | 5 |
| A-INL-PG16-P-GY | 1411225 | 5 |
| A-INL-PG21-P-GY | 1411226 | 5 |
| A-INL-PG29-P-GY | 1411227 | 5 |
| A-INL-PG36-P-GY | 1411228 | 5 |
| A-INL-PG42-P-GY | 1411229 | 5 |
| A-INL-PG48-P-GY | 1411230 | 5 |

**Plastic cable gland,
NPT, ANSI B1.20.1**

- Material: polyamide 6
- Color: silver-gray (RAL 7001)
- Seal: neoprene
- Ambient temperature:
-30°C ... +80°C (+150°C briefly)
- Degree of protection: IP68, 5 bar
- Strain relief: integrated according to EN 50262

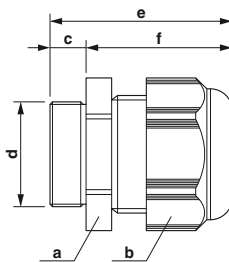

Plastic cable gland



243143 / QCRV.E320158

Ordering data

| Thread type | Clamping area [mm] | Dimensions [mm] | | | | | | |
|-------------|-----------------------|-----------------|-------|-------|-------|-------|-------|---|
| | | a | b | c | d | e | f | g |
| NPT3/8" | 5.00 - 10.00 | 22.00 | 22.00 | 15.00 | 16.60 | 44.50 | 29.50 | - |
| NPT1/2" | 10.00 - 14.00 | 27.00 | 27.00 | 15.00 | 20.60 | 47.10 | 32.10 | - |
| NPT3/4" | 13.00 - 18.00 | 33.00 | 33.00 | 15.00 | 25.90 | 47.50 | 35.50 | - |
| NPT1" | 18.00 - 25.00 | 42.00 | 42.00 | 18.00 | 32.40 | 58.50 | 40.50 | - |

| Type | Order No. | Pcs. / Pkt. |
|-------------------------|-----------|-------------|
| G-INS-N3/8-S68L-PNES-GY | 1411152 | 10 |
| G-INS-N1/2-S68L-PNES-GY | 1411153 | 10 |
| G-INS-N3/4-M68L-PNES-GY | 1411154 | 5 |
| G-INS-N1-M68L-PNES-GY | 1411155 | 5 |

**Plastic counter nut,
NPT, ANSI B1.20.1**

- Material: polyamide 6
- Color: silver-gray (RAL 7001)
- Ambient temperature:
-20°C ... +80°C

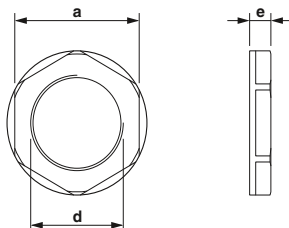

Plastic counter nut

| Thread type | Clamping area [mm] | Dimensions [mm] | | | | | | |
|-------------|-----------------------|-----------------|---|---|-------|------|---|---|
| | | a | b | c | d | e | f | g |
| NPT3/8" | - | 22.00 | - | - | 16.60 | 5.00 | - | - |
| NPT1/2" | - | 27.00 | - | - | 20.60 | 5.00 | - | - |
| NPT3/4" | - | 33.00 | - | - | 25.90 | 5.00 | - | - |
| NPT1" | - | 47.00 | - | - | 32.40 | 6.00 | - | - |

Ordering data

| Type | Order No. | Pcs. / Pkt. |
|-------------------|-----------|-------------|
| A-INL-NPT3/8-P-GY | 1411231 | 10 |
| A-INL-NPT1/2-P-GY | 1411233 | 10 |
| A-INL-NPT3/4-P-GY | 1411234 | 5 |
| A-INL-NPT1-P-GY | 1411235 | 5 |

Installation and mounting material - cable glands

Plastic cable gland, NPT, ANSI B1.20.1

- Material: polyamide 6
- Color: deep black (RAL 9005)
- Seal: neoprene
- Ambient temperature:
-30°C ... +80°C (+150°C briefly)
- Degree of protection: IP68, 5 bar
- Strain relief: integrated according to EN 50262

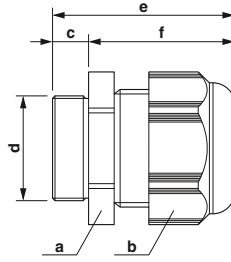

Plastic cable gland



243143 / QCRV.E320158

Ordering data

| Thread type | Clamping area [mm] | Dimensions [mm] | | | | | | |
|-------------|-----------------------|-----------------|-------|-------|-------|-------|-------|---|
| | | a | b | c | d | e | f | g |
| NPT3/8" | 5.00 - 10.00 | 22.00 | 22.00 | 15.00 | 16.60 | 44.50 | 29.50 | - |
| NPT1/2" | 10.00 - 14.00 | 27.00 | 27.00 | 15.00 | 20.60 | 47.10 | 32.10 | - |
| NPT3/4" | 13.00 - 18.00 | 33.00 | 33.00 | 12.00 | 25.90 | 47.50 | 35.50 | - |
| NPT1" | 18.00 - 25.00 | 42.00 | 42.00 | 18.00 | 32.40 | 58.50 | 40.50 | - |

| Type | Order No. | Pcs. / Pkt. |
|-------------------------|-----------|-------------|
| G-INS-N3/8-S68L-PNES-BK | 1411156 | 10 |
| G-INS-N1/2-S68L-PNES-BK | 1411157 | 10 |
| G-INS-N3/4-M68L-PNES-BK | 1411158 | 5 |
| G-INS-N1-M68L-PNES-BK | 1411159 | 5 |

Plastic counter nut, NPT, ANSI B1.20.1

- Material: polyamide 6
- Color: deep black (RAL 9005)
- Ambient temperature:
-20°C ... +80°C

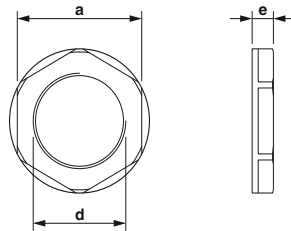

Plastic counter nut

| Thread type | Clamping area [mm] | Dimensions [mm] | | | | | | |
|-------------|-----------------------|-----------------|---|---|-------|------|---|---|
| | | a | b | c | d | e | f | g |
| NPT3/8" | - | 22.00 | - | - | 16.60 | 5.00 | - | - |
| NPT1/2" | - | 27.00 | - | - | 20.60 | 5.00 | - | - |
| NPT3/4" | - | 33.00 | - | - | 25.90 | 5.00 | - | - |
| NPT1" | - | 47.00 | - | - | 32.40 | 6.00 | - | - |

Ordering data

| Type | Order No. | Pcs. / Pkt. |
|-------------------|-----------|-------------|
| A-INL-NPT3/8-P-BK | 1411236 | 10 |
| A-INL-NPT1/2-P-BK | 1411237 | 10 |
| A-INL-NPT3/4-P-BK | 1411238 | 5 |
| A-INL-NPT1-P-BK | 1411239 | 5 |

Brass cable gland, metric, EN 60423

- Material: brass, nickel-plated
- Seal: neoprene
- Clamping insert: polyamide 6
- O-ring: NBR
- Ambient temperature: -40°C ... +100°C
- Degree of protection: IP69K
- Strain relief: integrated according to EN 50262

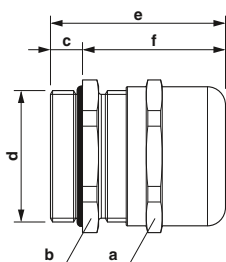

Brass cable gland

QCRV.E320158

Ordering data

| Thread type | Clamping area [mm] | Dimensions [mm] | | | | | | |
|-------------|--------------------|-----------------|-------|-------|-------|-------|-------|---|
| | | a | b | c | d | e | f | g |
| M12 | 3.00 - 6.50 | 14.00 | 14.00 | 6.00 | 12.00 | 27.80 | 21.80 | - |
| M16 | 5.00 - 10.00 | 20.00 | 20.00 | 7.00 | 16.00 | 34.50 | 27.50 | - |
| M20 | 6.00 - 12.00 | 22.00 | 22.00 | 8.00 | 20.00 | 37.50 | 29.50 | - |
| M25 | 11.00 - 17.00 | 27.00 | 27.00 | 8.00 | 25.00 | 40.00 | 32.00 | - |
| M32 | 15.00 - 21.00 | 34.00 | 34.00 | 8.00 | 32.00 | 43.00 | 35.00 | - |
| M40 | 19.00 - 28.00 | 43.00 | 43.00 | 9.00 | 40.00 | 53.70 | 44.70 | - |
| M50 | 27.00 - 38.00 | 58.00 | 58.00 | 9.00 | 50.00 | 61.00 | 52.00 | - |
| M63 | 34.00 - 44.00 | 64.00 | 68.00 | 14.00 | 63.00 | 65.20 | 51.20 | - |

| Type | Order No. | Pcs. / Pkt. |
|-----------------------|-----------|-------------|
| G-INS-M12-S68N-NNES-S | 1411160 | 10 |
| G-INS-M16-S68N-NNES-S | 1411162 | 10 |
| G-INS-M20-S68N-NNES-S | 1411163 | 5 |
| G-INS-M25-M68N-NNES-S | 1411165 | 5 |
| G-INS-M32-M68N-NNES-S | 1411166 | 5 |
| G-INS-M40-M68N-NNES-S | 1411167 | 5 |
| G-INS-M50-L68N-NNES-S | 1411168 | 1 |
| G-INS-M63-L68N-NNES-S | 1411169 | 1 |

Brass counter nut, metric, EN 60423

- Material: brass, nickel-plated
- Ambient temperature: -70°C ... +220°C

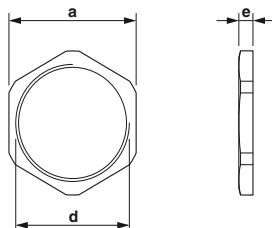

Brass counter nut

Ordering data

| Thread type | Clamping area [mm] | Dimensions [mm] | | | | | | |
|-------------|--------------------|-----------------|---|---|-------|------|---|---|
| | | a | b | c | d | e | f | g |
| M12 | - | 15.00 | - | - | 12.00 | 2.80 | - | - |
| M16 | - | 19.00 | - | - | 16.00 | 2.80 | - | - |
| M20 | - | 24.00 | - | - | 20.00 | 3.00 | - | - |
| M25 | - | 30.00 | - | - | 25.00 | 3.50 | - | - |
| M32 | - | 36.00 | - | - | 32.00 | 4.00 | - | - |
| M40 | - | 46.00 | - | - | 40.00 | 5.00 | - | - |
| M50 | - | 57.00 | - | - | 50.00 | 5.00 | - | - |
| M63 | - | 70.00 | - | - | 63.00 | 6.00 | - | - |

| Type | Order No. | Pcs. / Pkt. |
|---------------|-----------|-------------|
| A-INL-M12-N-S | 1411240 | 100 |
| A-INL-M16-N-S | 1411241 | 100 |
| A-INL-M20-N-S | 1411242 | 100 |
| A-INL-M25-N-S | 1411243 | 100 |
| A-INL-M32-N-S | 1411244 | 100 |
| A-INL-M40-N-S | 1411246 | 50 |
| A-INL-M50-N-S | 1411247 | 25 |
| A-INL-M63-N-S | 1411248 | 25 |

Installation and mounting material - cable glands

Brass cable gland, Pg, EN 40430

- Material: brass, nickel-plated
- Seal: neoprene
- Clamping insert: polyamide 6
- O-ring: NBR
- Ambient temperature: -40°C ... +100°C
- Degree of protection: IP68/IP69K
- Strain relief: integrated according to EN 50262

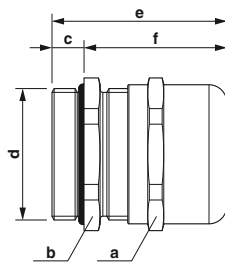

Brass cable gland

QCRV.E320158

Ordering data

| Thread type | Clamping area [mm] | Dimensions [mm] | | | | | | |
|-------------|--------------------|-----------------|-------|-------|-------|-------|-------|---|
| | | a | b | c | d | e | f | g |
| Pg7 | 3.00 - 6.50 | 14.00 | 14.00 | 6.00 | 12.50 | 27.80 | 21.80 | - |
| Pg9 | 4.00 - 8.00 | 17.00 | 17.00 | 6.00 | 15.20 | 28.20 | 22.20 | - |
| Pg11 | 5.00 - 10.00 | 20.00 | 20.00 | 6.00 | 18.60 | 21.00 | 15.00 | - |
| Pg13.5 | 6.00 - 12.00 | 22.00 | 22.00 | 6.50 | 20.40 | 30.50 | 24.00 | - |
| Pg16 | 10.00 - 14.00 | 24.00 | 24.00 | 6.50 | 22.50 | 33.90 | 27.40 | - |
| Pg21 | 13.00 - 18.00 | 30.00 | 30.00 | 7.20 | 28.30 | 38.50 | 31.30 | - |
| Pg29 | 18.00 - 25.00 | 40.00 | 40.00 | 8.00 | 37.00 | 46.90 | 38.90 | - |
| Pg36 | 22.00 - 32.00 | 50.00 | 50.00 | 9.00 | 47.00 | 57.20 | 48.20 | - |
| Pg42 | 30.00 - 38.00 | 58.00 | 58.00 | 12.00 | 54.00 | 60.00 | 48.00 | - |
| Pg48 | 34.00 - 44.00 | 64.00 | 64.00 | 14.00 | 59.30 | 63.40 | 49.40 | - |

| Type | Order No. | Pcs. / Pkt. |
|--------------------------|-----------|-------------|
| G-INS-PG7-S68N-NNES-S | 1411170 | 10 |
| G-INS-PG9-S68N-NNES-S | 1411171 | 10 |
| G-INS-PG11-S68N-NNES-S | 1411172 | 5 |
| G-INS-PG13,5-S68N-NNES-S | 1411173 | 5 |
| G-INS-PG16-S68N-NNES-S | 1411174 | 5 |
| G-INS-PG21-M68N-NNES-S | 1411175 | 5 |
| G-INS-PG29-M68N-NNES-S | 1411176 | 5 |
| G-INS-PG36-L68N-NNES-S | 1411178 | 5 |
| G-INS-PG42-L68N-NNES-S | 1411179 | 1 |
| G-INS-PG48-L68N-NNES-S | 1411181 | 1 |

Brass counter nut, Pg, EN 40430

- Material: brass, nickel-plated
- Ambient temperature: -70°C ... +220°C

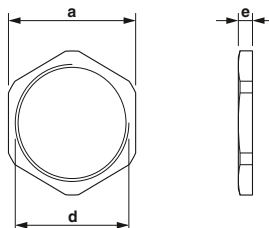

Brass counter nut

Ordering data

| Thread type | Clamping area [mm] | Dimensions [mm] | | | | | | |
|-------------|--------------------|-----------------|---|---|-------|------|---|---|
| | | a | b | c | d | e | f | g |
| Pg7 | - | 15.00 | - | - | 12.50 | 2.80 | - | - |
| Pg9 | - | 18.00 | - | - | 15.20 | 2.80 | - | - |
| Pg11 | - | 21.00 | - | - | 18.60 | 3.00 | - | - |
| Pg13.5 | - | 23.00 | - | - | 20.40 | 3.00 | - | - |
| Pg16 | - | 26.00 | - | - | 22.50 | 3.00 | - | - |
| Pg21 | - | 32.00 | - | - | 28.30 | 3.50 | - | - |
| Pg29 | - | 41.00 | - | - | 37.00 | 4.00 | - | - |
| Pg36 | - | 51.00 | - | - | 47.00 | 5.00 | - | - |
| Pg42 | - | 60.00 | - | - | 54.00 | 5.00 | - | - |
| Pg48 | - | 64.00 | - | - | 59.30 | 5.50 | - | - |

| Type | Order No. | Pcs. / Pkt. |
|------------------|-----------|-------------|
| A-INL-PG7-N-S | 1411255 | 100 |
| A-INL-PG9-N-S | 1411256 | 100 |
| A-INL-PG11-N-S | 1411257 | 100 |
| A-INL-PG13,5-N-S | 1411259 | 100 |
| A-INL-PG16-N-S | 1411260 | 100 |
| A-INL-PG21-N-S | 1411262 | 100 |
| A-INL-PG29-N-S | 1411263 | 50 |
| A-INL-PG36-N-S | 1411264 | 50 |
| A-INL-PG42-N-S | 1411265 | 25 |
| A-INL-PG48-N-S | 1411266 | 25 |

**Brass cable gland,
NPT, ANSI B1.20.1**

- Material: brass, nickel-plated
- Seal: neoprene
- Clamping insert: polyamide 6
- O-ring: NBR
- Ambient temperature:
-40°C ... +100°C
- Degree of protection: IP68, 5 bar
- Strain relief: integrated according to
EN 50262

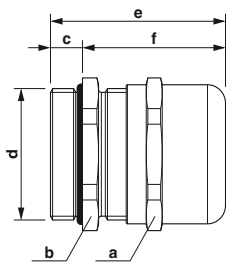

Brass cable gland

UL
QCRV2.E320158

Ordering data

| Thread type | Clamping area [mm] | Dimensions [mm] | | | | | | |
|-------------|-----------------------|-----------------|-------|-------|-------|-------|-------|---|
| | | a | b | c | d | e | f | g |
| NPT3/8" | 5.00 - 10.00 | 17.00 | 19.00 | 11.50 | 16.00 | 34.50 | 23.00 | - |
| NPT1/2" | 10.00 - 14.00 | 22.00 | 22.00 | 13.00 | 21.00 | 39.00 | 26.00 | - |
| NPT3/4" | 13.00 - 18.00 | 30.00 | 30.00 | 13.00 | 29.00 | 48.50 | 35.50 | - |
| NPT1" | 18.00 - 25.00 | 40.00 | 43.00 | 13.00 | 32.00 | 56.00 | 43.00 | - |

| Type | Order No. | Pcs. / Pkt. |
|--------------------------|-----------|----------------|
| G-INS-NPT3/8-S68L-NNES-S | 1411182 | 10 |
| G-INS-NPT1/2-S68L-NNES-S | 1411183 | 10 |
| G-INS-NPT3/4-M68L-NNES-S | 1411184 | 5 |
| G-INS-NPT1-M68L-NNES-S | 1411185 | 5 |

Installation and mounting material - cable glands

Brass EMC cable gland, metric, EN 60423

- Material: brass, nickel-plated
- Seal: CR/NBR
- Clamping insert: polyamide 6
- Contact spring: stainless steel
- O-ring: NBR
- Ambient temperature (operation): -20°C ... +100°C
- Degree of protection: IP68
- Strain relief: integrated according to EN 50262

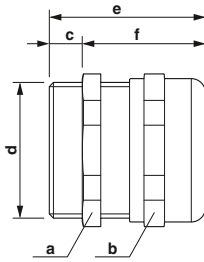

Brass cable gland



QCRV.E140310 / QCRV2.E140310

| Thread type | Clamping area [mm] | Dimensions [mm] | | | | | | |
|-------------|--------------------|-----------------|-------|-------|-------|-------|-------|---|
| | | a | b | c | d | e | f | g |
| M12 | 3.00 - 6.50 | 14.00 | 14.00 | 6.00 | 12.00 | 28.00 | 22.00 | - |
| M16 | 5.00 - 9.00 | 17.00 | 17.00 | 5.00 | 16.00 | 30.00 | 25.00 | - |
| M20 | 9.00 - 13.00 | 22.00 | 22.00 | 6.00 | 20.00 | 33.50 | 27.50 | - |
| M25 | 11.00 - 16.00 | 27.00 | 27.00 | 7.00 | 25.00 | 36.50 | 29.50 | - |
| M32 | 14.00 - 21.00 | 34.00 | 34.00 | 8.00 | 32.00 | 38.00 | 30.00 | - |
| M40 | 19.00 - 27.00 | 43.00 | 43.00 | 8.00 | 40.00 | 41.00 | 33.00 | - |
| M50 | 24.00 - 35.00 | 55.00 | 55.00 | 9.00 | 50.00 | 49.50 | 40.50 | - |
| M63 | 32.00 - 42.00 | 65.00 | 65.00 | 10.00 | 63.00 | 52.50 | 42.50 | - |

Ordering data

| Type | Order No. | Pcs. / Pkt. |
|-------------------------|-----------|-------------|
| G-INSEC-M12-S68N-NCRS-S | 1411187 | 10 |
| G-INSEC-M16-S68N-NCRS-S | 1411188 | 10 |
| G-INSEC-M20-S68N-NCRS-S | 1411189 | 5 |
| G-INSEC-M25-S68N-NCRS-S | 1411190 | 5 |
| G-INSEC-M32-M68N-NCRS-S | 1411191 | 5 |
| G-INSEC-M40-M68N-NCRS-S | 1411192 | 5 |
| G-INSEC-M50-L68N-NCRS-S | 1411193 | 1 |
| G-INSEC-M63-L68N-NCRS-S | 1411194 | 1 |

Brass counter nut, metric, EN 60423, ribbed

- Material: brass, nickel-plated
- Ambient temperature: -70°C ... +220°C
- Version: ribbed

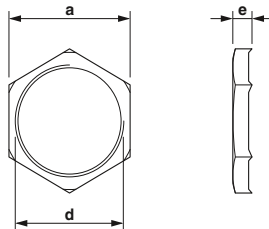

Brass counter nut

| Thread type | Clamping area [mm] | Dimensions [mm] | | | | | | |
|-------------|--------------------|-----------------|---|---|-------|------|---|---|
| | | a | b | c | d | e | f | g |
| M12 | - | 15.00 | - | - | 12.00 | 4.70 | - | - |
| M16 | - | 19.00 | - | - | 16.00 | 4.70 | - | - |
| M20 | - | 24.00 | - | - | 20.00 | 4.70 | - | - |
| M25 | - | 30.00 | - | - | 25.00 | 5.20 | - | - |
| M32 | - | 36.00 | - | - | 32.00 | 5.70 | - | - |
| M40 | - | 46.00 | - | - | 40.00 | 6.50 | - | - |
| M50 | - | 57.00 | - | - | 50.00 | 6.50 | - | - |
| M63 | - | 70.00 | - | - | 63.00 | 7.00 | - | - |

Ordering data

| Type | Order No. | Pcs. / Pkt. |
|----------------|-----------|-------------|
| A-INLE-M12-N-S | 1411267 | 100 |
| A-INLE-M16-N-S | 1411268 | 100 |
| A-INLE-M20-N-S | 1411269 | 100 |
| A-INLE-M25-N-S | 1411270 | 50 |
| A-INLE-M32-N-S | 1411271 | 50 |
| A-INLE-M40-N-S | 1411272 | 50 |
| A-INLE-M50-N-S | 1411273 | 10 |
| A-INLE-M63-N-S | 1411274 | 10 |

**Brass EMC cable gland,
Pg, EN 40430**

- Material: brass, nickel-plated
- Seal: neoprene
- Clamping insert: polyamide 6
- Contact spring: copper beryllium
- O-ring: NBR
- Ambient temperature:
-40°C ... +100°C
- Degree of protection: IP68
- Strain relief: integrated according to EN 50262

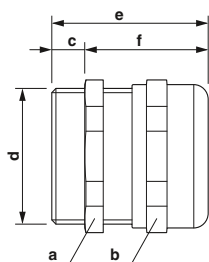

Brass cable gland

UL
QCRV2.E320158

| Thread type | Clamping area [mm] | Dimensions [mm] | | | | | | |
|-------------|-----------------------|-----------------|-------|-------|-------|-------|-------|---|
| | | a | b | c | d | e | f | g |
| Pg7 | 3.00 - 6.50 | 14.00 | 14.00 | 6.00 | 12.50 | 27.00 | 21.00 | - |
| Pg9 | 4.00 - 8.00 | 17.00 | 17.00 | 6.00 | 15.20 | 29.00 | 23.00 | - |
| Pg11 | 5.00 - 10.00 | 20.00 | 20.00 | 6.00 | 18.60 | 30.00 | 24.00 | - |
| Pg13.5 | 6.00 - 12.00 | 22.00 | 22.00 | 6.50 | 20.40 | 30.00 | 23.50 | - |
| Pg16 | 10.00 - 14.00 | 24.00 | 24.00 | 6.50 | 22.50 | 33.90 | 27.40 | - |
| Pg21 | 13.00 - 18.00 | 30.00 | 30.00 | 7.20 | 28.30 | 38.50 | 31.30 | - |
| Pg29 | 18.00 - 25.00 | 40.00 | 40.00 | 8.00 | 37.00 | 47.00 | 39.00 | - |
| Pg36 | 22.00 - 32.00 | 50.00 | 50.00 | 9.00 | 47.00 | 57.00 | 48.00 | - |
| Pg42 | 30.00 - 38.00 | 58.00 | 58.00 | 12.00 | 54.00 | 60.00 | 48.00 | - |
| Pg48 | 34.00 - 44.00 | 64.00 | 64.00 | 14.00 | 59.30 | 65.00 | 51.00 | - |

| Ordering data | | |
|----------------------------|-----------|-------------|
| Type | Order No. | Pcs. / Pkt. |
| G-INSEC-PG7-S68N-NNES-S | 1411195 | 10 |
| G-INSEC-PG9-S68N-NNES-S | 1411196 | 10 |
| G-INSEC-PG11-S68N-NNES-S | 1411197 | 5 |
| G-INSEC-PG13,5-S68N-NNES-S | 1411198 | 5 |
| G-INSEC-PG16-S68N-NNES-S | 1411199 | 5 |
| G-INSEC-PG21-M68N-NNES-S | 1411200 | 5 |
| G-INSEC-PG29-M68N-NNES-S | 1411201 | 5 |
| G-INSEC-PG36-L68N-NNES-S | 1411202 | 5 |
| G-INSEC-PG42-L68N-NNES-S | 1411203 | 1 |
| G-INSEC-PG48-L68N-NNES-S | 1411204 | 1 |

**Brass counter nut,
Pg, EN 40430, ribbed**

- Material: brass, nickel-plated
- Ambient temperature:
-70°C ... +220°C
- Version: ribbed

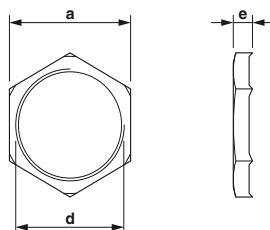

Brass counter nut

| Thread type | Clamping area [mm] | Dimensions [mm] | | | | | | |
|-------------|-----------------------|-----------------|---|---|-------|------|---|---|
| | | a | b | c | d | e | f | g |
| Pg7 | - | 15.00 | - | - | 12.50 | 4.70 | - | - |
| Pg9 | - | 18.00 | - | - | 15.20 | 4.70 | - | - |
| Pg11 | - | 21.00 | - | - | 18.60 | 4.70 | - | - |
| Pg13.5 | - | 23.00 | - | - | 20.40 | 4.70 | - | - |
| Pg16 | - | 26.00 | - | - | 22.50 | 4.70 | - | - |
| Pg21 | - | 32.00 | - | - | 28.30 | 5.20 | - | - |
| Pg29 | - | 41.00 | - | - | 37.00 | 5.70 | - | - |
| Pg36 | - | 51.00 | - | - | 47.00 | 6.50 | - | - |

| Ordering data | | |
|-------------------|-----------|-------------|
| Type | Order No. | Pcs. / Pkt. |
| A-INLE-PG7-N-S | 1411275 | 100 |
| A-INLE-PG9-N-S | 1411276 | 100 |
| A-INLE-PG11-N-S | 1411277 | 100 |
| A-INLE-PG13,5-N-S | 1411278 | 100 |
| A-INLE-PG16-N-S | 1411279 | 100 |
| A-INLE-PG21-N-S | 1411280 | 50 |
| A-INLE-PG29-N-S | 1411281 | 50 |
| A-INLE-PG36-N-S | 1411282 | 50 |

Installation and mounting material - cable glands

Brass cable gland, metric, Ex protection

Cable glands for unarmored and braided cables provide flameproof (type "d"), increased safety (type "e"), and restricted breathing (type "nR") hazardous area protection to IP66, IP67, and IP68.

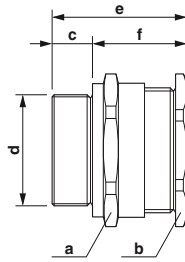

Brass cable gland

Ex: SIRI13ATEX1068X / IECEx SIR13.0023X

General data

Cable gland material
Seal material
O-ring material
Ambient temperature (operation)

Technical data

Nickel-plated brass
Thermoplastic elastomers
Viton
-60°C ... 130°C

| Thread type | Clamping area [mm] | Dimensions [mm] | | | | | | |
|-------------|--------------------|-----------------|-------|-------|-------|-------|-------|---|
| | | a | b | c | d | e | f | g |
| M20 | 6.50 - 14.00 | 27.00 | 27.00 | 15.00 | 20.00 | 39.00 | 24.00 | - |
| M25 | 11.10 - 20.00 | 36.00 | 36.00 | 15.00 | 25.00 | 41.00 | 26.00 | - |
| M32 | 17.00 - 26.30 | 41.00 | 41.00 | 15.00 | 32.00 | 42.00 | 27.00 | - |
| M40 | 23.50 - 32.20 | 50.00 | 50.00 | 15.00 | 40.00 | 43.00 | 28.00 | - |
| M50 | 35.60 - 44.10 | 60.00 | 60.00 | 15.00 | 50.00 | 45.00 | 30.00 | - |
| M63 | 47.20 - 56.00 | 75.00 | 75.00 | 15.00 | 63.00 | 45.00 | 30.00 | - |

Ordering data

| Type | Order No. | Pcs. / Pkt. |
|-----------------------|-----------|-------------|
| G-ESS-M20-S66L-NTES-S | 1411075 | 20 |
| G-ESS-M25-M66L-NTES-S | 1411077 | 20 |
| G-ESS-M32-M66L-NTES-S | 1411079 | 10 |
| G-ESS-M40-L66L-NTES-S | 1411081 | 2 |
| G-ESS-M50-L66L-NTES-S | 1411084 | 2 |
| G-ESS-M63-L66L-NTES-S | 1411086 | 2 |

Stainless steel cable gland, metric, Ex protection

Cable glands for unarmored and braided cables provide flameproof (type "d"), increased safety (type "e"), and restricted breathing (type "nR") hazardous area protection to IP66, IP67, and IP68.

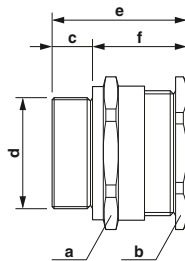

Stainless steel cable gland

Ex: SIRI13ATEX1068X / IECEx SIR13.0023X

General data

Cable gland material
Seal material
O-ring material
Ambient temperature (operation)

Technical data

High-grade steel
Thermoplastic elastomers
Viton
-60°C ... 130°C

| Thread type | Clamping area [mm] | Dimensions [mm] | | | | | | |
|-------------|--------------------|-----------------|-------|-------|-------|-------|-------|---|
| | | a | b | c | d | e | f | g |
| M20 | 6.50 - 14.00 | 27.00 | 27.00 | 15.00 | 20.00 | 39.00 | 24.00 | - |
| M25 | 11.10 - 20.00 | 36.00 | 36.00 | 15.00 | 25.00 | 41.00 | 26.00 | - |
| M32 | 17.00 - 26.30 | 41.00 | 41.00 | 15.00 | 32.00 | 42.00 | 27.00 | - |
| M40 | 23.50 - 32.20 | 50.00 | 50.00 | 15.00 | 40.00 | 43.00 | 28.00 | - |
| M50 | 35.60 - 44.10 | 60.00 | 60.00 | 15.00 | 50.00 | 45.00 | 30.00 | - |
| M63 | 47.20 - 56.00 | 75.00 | 75.00 | 15.00 | 63.00 | 45.00 | 30.00 | - |

Ordering data

| Type | Order No. | Pcs. / Pkt. |
|-----------------------|-----------|-------------|
| G-ESS-M20-S66L-STES-S | 1411076 | 20 |
| G-ESS-M25-M66L-STES-S | 1411078 | 20 |
| G-ESS-M32-M66L-STES-S | 1411080 | 10 |
| G-ESS-M40-L66L-STES-S | 1411082 | 2 |
| G-ESS-M50-L66L-STES-S | 1411085 | 2 |
| G-ESS-M63-L66L-STES-S | 1411087 | 2 |

Brass cable gland, metric, Ex protection

Cable glands for armored cables provide increased safety (type "e") hazardous area protection to IP66, IP67, and IP68.



Brass cable gland

Ex: SIR13ATEX1070X / IECEx SIR13.0025X

General data

Cable gland material
Seal material
O-ring material
Ambient temperature (operation)

Technical data

Nickel-plated brass
Thermoplastic elastomers
Viton
-60°C ... 130°C

| Thread type | Clamping area [mm] | Dimensions [mm] | | | | | | |
|-------------|--------------------|-----------------|-------|-------|-------|--------|-------|---|
| | | a | b | c | d | e | f | g |
| M20 | 9.50 - 15.90 | 24.00 | 24.00 | 15.00 | 20.00 | 73.50 | 58.50 | - |
| M20 | 12.50 - 20.90 | 30.50 | 30.50 | 15.00 | 20.00 | 75.50 | 60.50 | - |
| M25 | 18.20 - 26.20 | 37.50 | 37.50 | 15.00 | 25.00 | 82.50 | 67.50 | - |
| M32 | 23.70 - 33.90 | 46.00 | 46.00 | 15.00 | 32.00 | 84.50 | 69.50 | - |
| M40 | 27.90 - 40.40 | 55.00 | 55.00 | 15.00 | 40.00 | 93.00 | 78.00 | - |
| M50 | 40.40 - 53.10 | 70.00 | 70.00 | 15.00 | 50.00 | 95.50 | 80.50 | - |
| M63 | 54.60 - 65.90 | 80.00 | 80.00 | 15.00 | 63.00 | 107.00 | 92.00 | - |

Ordering data

| Type | Order No. | Pcs. / Pkt. |
|--------------------------|-----------|-------------|
| G-ESSWU-M20S-S66L-NTES-S | 1411088 | 10 |
| G-ESSWU-M20-M66L-NTES-S | 1411090 | 10 |
| G-ESSWU-M25-M66L-NTES-S | 1411092 | 10 |
| G-ESSWU-M32-L66L-NTES-S | 1411094 | 5 |
| G-ESSWU-M40-L66L-NTES-S | 1411097 | 1 |
| G-ESSWU-M50-L66L-NTES-S | 1411100 | 1 |
| G-ESSWU-M63-L66L-NTES-S | 1411102 | 1 |

Stainless steel cable gland, metric, Ex protection

Cable glands for armored cables provide flameproof (type "d"), increased safety (type "e"), and restricted breathing (type "nR") hazardous area protection to IP66, IP67, and IP68.



Stainless steel cable gland

Ex: SIR13ATEX1073X / IECEx SIR13.0028X

General data

Cable gland material
Seal material
O-ring material
Ambient temperature (operation)

Technical data

High-grade steel
Thermoplastic elastomers
Viton
-60°C ... 130°C

| Thread type | Clamping area [mm] | Dimensions [mm] | | | | | | |
|-------------|--------------------|-----------------|-------|-------|-------|--------|-------|---|
| | | a | b | c | d | e | f | g |
| M20 | 9.50 - 15.90 | 24.00 | 24.00 | 15.00 | 20.00 | 73.50 | 58.50 | - |
| M20 | 12.50 - 20.90 | 30.50 | 30.50 | 15.00 | 20.00 | 75.50 | 60.50 | - |
| M25 | 18.20 - 26.20 | 37.50 | 37.50 | 15.00 | 25.00 | 82.50 | 67.50 | - |
| M32 | 23.70 - 33.90 | 46.00 | 46.00 | 15.00 | 32.00 | 84.50 | 69.50 | - |
| M40 | 27.90 - 40.40 | 55.00 | 55.00 | 15.00 | 40.00 | 93.00 | 78.00 | - |
| M50 | 40.40 - 53.10 | 70.00 | 70.00 | 15.00 | 50.00 | 95.50 | 80.50 | - |
| M63 | 54.60 - 65.90 | 80.00 | 80.00 | 15.00 | 63.00 | 107.00 | 92.00 | - |

Ordering data

| Type | Order No. | Pcs. / Pkt. |
|--------------------------|-----------|-------------|
| G-EDSWU-M20S-S66L-STES-S | 1411089 | 10 |
| G-EDSWU-M20-M66L-STES-S | 1411091 | 10 |
| G-EDSWU-M25-M66L-STES-S | 1411093 | 10 |
| G-EDSWU-M32-L66L-STES-S | 1411095 | 5 |
| G-EDSWU-M40-L66L-STES-S | 1411099 | 1 |
| G-EDSWU-M50-L66L-STES-S | 1411101 | 1 |
| G-EDSWU-M63-L66L-STES-S | 1411103 | 1 |

Installation and mounting material - cable glands

Brass screw plug, metric, Ex protection

Screw plugs provide IP66 and IP68 protection when installed with an entry thread ring, sealing unused cable entries in flameproof (type "d") and increased safety (type "e") installations.

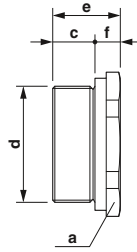

Brass screw plug

Ex:
SIRA01ATEX1284U / IECEx SIR07.0083X

General data

Material
Ambient temperature (operation)

Technical data

Nickel-plated brass
-60°C ... 200°C

| Thread type | Clamping area [mm] | Dimensions [mm] | | | | | | |
|-------------|-----------------------|-----------------|---|-------|-------|-------|------|---|
| | | a | b | c | d | e | f | g |
| M20 | - | 24.00 | - | 15.00 | 20.00 | 24.00 | 9.00 | - |
| M25 | - | 30.00 | - | 15.00 | 25.00 | 24.00 | 9.00 | - |
| M32 | - | 36.00 | - | 15.00 | 32.00 | 24.00 | 9.00 | - |
| M40 | - | 46.00 | - | 15.00 | 40.00 | 24.00 | 9.00 | - |
| M50 | - | 55.00 | - | 15.00 | 50.00 | 24.00 | 9.00 | - |
| M63 | - | 65.00 | - | 15.00 | 63.00 | 24.00 | 9.00 | - |

Ordering data

| Type | Order No. | Pcs. / Pkt. |
|--------------------|-----------|-------------|
| A-EXSH-M20-68L-N-S | 1411104 | 20 |
| A-EXSH-M25-68L-N-S | 1411107 | 20 |
| A-EXSH-M32-68L-N-S | 1411109 | 10 |
| A-EXSH-M40-68L-N-S | 1411111 | 5 |
| A-EXSH-M50-68L-N-S | 1411113 | 2 |
| A-EXSH-M63-68L-N-S | 1411115 | 1 |

Stainless steel screw plug, metric, Ex protection

Screw plugs provide IP66 and IP68 protection when installed with an entry thread ring, sealing unused cable entries in flameproof (type "d") and increased safety (type "e") installations.

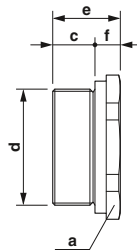

Stainless steel screw plug

Ex:
SIRA01ATEX1284U / IECEx SIR07.0083X

General data

Material
Ambient temperature (operation)

Technical data

High-grade steel
-60°C ... 200°C

| Thread type | Clamping area [mm] | Dimensions [mm] | | | | | | |
|-------------|-----------------------|-----------------|---|-------|-------|-------|------|---|
| | | a | b | c | d | e | f | g |
| M20 | - | 24.00 | - | 15.00 | 20.00 | 24.00 | 9.00 | - |
| M25 | - | 30.00 | - | 15.00 | 25.00 | 24.00 | 9.00 | - |
| M32 | - | 36.00 | - | 15.00 | 32.00 | 24.00 | 9.00 | - |
| M40 | - | 46.00 | - | 15.00 | 40.00 | 24.00 | 9.00 | - |
| M50 | - | 55.00 | - | 15.00 | 50.00 | 24.00 | 9.00 | - |
| M63 | - | 65.00 | - | 15.00 | 63.00 | 24.00 | 9.00 | - |

Ordering data

| Type | Order No. | Pcs. / Pkt. |
|--------------------|-----------|-------------|
| A-EXSH-M20-68L-S-S | 1411105 | 20 |
| A-EXSH-M25-68L-S-S | 1411108 | 20 |
| A-EXSH-M32-68L-S-S | 1411110 | 10 |
| A-EXSH-M40-68L-S-S | 1411112 | 5 |
| A-EXSH-M50-68L-S-S | 1411114 | 2 |
| A-EXSH-M63-68L-S-S | 1411116 | 1 |

Brass pressure compensation, metric, Ex protection

Breather/drain plugs for increased safety (type "e") provide superior ventilation for devices. They are designed to act as a pressure compensation element preventing moisture build-up to IP66.

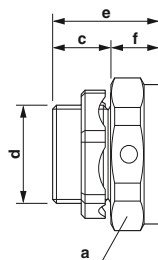

Brass pressure compensation

Ex: SIRI10ATEX1307U / IECEx SIR10.0149U

| General data | |
|---------------------------------|--|
| Material | |
| Ambient temperature (operation) | |

Technical data

Nickel-plated brass
-20°C ... 130°C

| Thread type | Clamping area [mm] | Dimensions [mm] | | | | | | |
|-------------|--------------------|-----------------|---|-------|-------|-------|-------|---|
| | | a | b | c | d | e | f | g |
| M20 | - | 30.00 | - | 15.00 | 20.00 | 28.00 | 13.00 | - |
| M25 | - | 36.00 | - | 15.00 | 25.00 | 28.00 | 13.00 | - |

Ordering data

| Type | Order No. | Pcs. / Pkt. |
|------------------|-----------|-------------|
| A-EXB-20-66L-N-S | 1411117 | 5 |
| A-EXB-25-66L-N-S | 1411120 | 5 |

Stainless steel pressure compensation, metric, Ex protection

Breather/drain plugs for increased safety (type "e") provide superior ventilation for devices. They are designed to act as a pressure compensation element preventing moisture build-up to IP66.

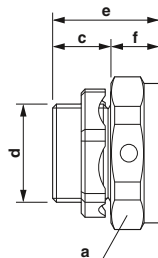

Stainless steel pressure compensation

Ex: SIRI10ATEX1307U / IECEx SIR10.0149U

| General data | |
|---------------------------------|--|
| Material | |
| Ambient temperature (operation) | |

Technical data

High-grade steel
-20°C ... 130°C

| Thread type | Clamping area [mm] | Dimensions [mm] | | | | | | |
|-------------|--------------------|-----------------|---|-------|-------|-------|-------|---|
| | | a | b | c | d | e | f | g |
| M20 | - | 30.00 | - | 15.00 | 20.00 | 28.00 | 13.00 | - |
| M25 | - | 36.00 | - | 15.00 | 25.00 | 28.00 | 13.00 | - |

Ordering data

| Type | Order No. | Pcs. / Pkt. |
|------------------|-----------|-------------|
| A-EXB-20-66L-S-S | 1411118 | 5 |
| A-EXB-25-66L-S-S | 1411121 | 5 |

Installation and mounting material - cable glands

Stainless steel counter nut, metric

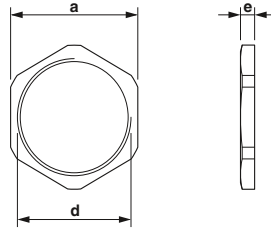

Stainless steel counter nut

General data

Material
Ambient temperature (operation)

High-grade steel
-70°C ... 220°C

Technical data

Ordering data

| Thread type | Clamping area [mm] | Dimensions [mm] | | | | | | |
|-------------|-----------------------|-----------------|---|---|-------|------|---|---|
| | | a | b | c | d | e | f | g |
| M20 | - | 24.00 | - | - | 20.00 | 3.00 | - | - |
| M25 | - | 30.00 | - | - | 25.00 | 3.50 | - | - |
| M32 | - | 36.00 | - | - | 32.00 | 4.00 | - | - |
| M40 | - | 46.00 | - | - | 40.00 | 5.00 | - | - |
| M50 | - | 55.00 | - | - | 50.00 | 5.00 | - | - |
| M63 | - | 70.00 | - | - | 63.00 | 6.00 | - | - |

| Type | Order No. | Pcs. / Pkt. |
|---------------|-----------|-------------|
| A-INL-M20-S-S | 1411249 | 10 |
| A-INL-M25-S-S | 1411250 | 10 |
| A-INL-M32-S-S | 1411251 | 5 |
| A-INL-M40-S-S | 1411252 | 5 |
| A-INL-M50-S-S | 1411253 | 2 |
| A-INL-M63-S-S | 1411254 | 1 |

Sealing washer, metric

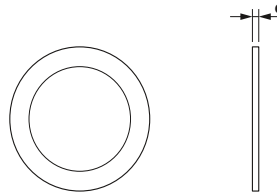

Sealing washer

General data

Material
Ambient temperature (operation)

Nylon
-70°C ... 100°C

Technical data

Ordering data

| Thread type | Clamping area [mm] | Dimensions [mm] | | | | | | |
|-------------|-----------------------|-----------------|---|---|---|------|---|---|
| | | a | b | c | d | e | f | g |
| M20 | - | - | - | - | - | 2.00 | - | - |
| M25 | - | - | - | - | - | 2.00 | - | - |
| M32 | - | - | - | - | - | 2.00 | - | - |
| M40 | - | - | - | - | - | 2.00 | - | - |
| M50 | - | - | - | - | - | 2.00 | - | - |
| M63 | - | - | - | - | - | 2.00 | - | - |

| Type | Order No. | Pcs. / Pkt. |
|--------------|-----------|-------------|
| A-SEW-20-P-W | 1411283 | 20 |
| A-SEW-25-P-W | 1411284 | 20 |
| A-SEW-32-P-W | 1411285 | 20 |
| A-SEW-40-P-W | 1411286 | 20 |
| A-SEW-50-P-W | 1411287 | 10 |
| A-SEW-63-P-W | 1411288 | 10 |



Desktop laser marker

TOPMARK LASER

Page 244



Stainless steel or aluminum laser cable marking

LS-WMTB ...

Page 246



Stainless steel or aluminum laser device marking

LS-EMSP ...
LS-EMLP ...
LS-EMP ...

Page 250
Page 252
Page 254



Plastic laser device marking

LS-EMLP ...

Page 256



Laser device marking, laser foil

LS-EML ...

Page 262



Terminal marking for terminal blocks from other manufacturers

UM1-TM ..., UM1U-TM ...,
UM1-TMF ...

Page 264



Terminal marking, marker strips

TMT ...

Page 266



UniCard conductor and cable marking

UCT-WMCO ...
UCT-WMTBA ...

Page 268
Page 270



Plastic cable markers

KMK HP ...
KMK UV ...

Page 272
Page 274



UniCard device marking, for applications in process technology and process engineering

UC-EMLP ... EX
EML ... EX

Page 276
Page 277

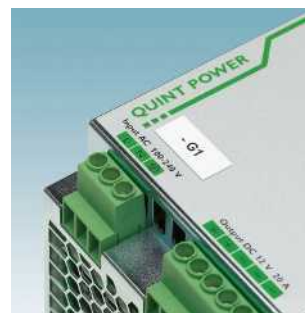

UniSheet device marking, with very high adhesive strength

US-EMLP-HA ...

Page 278



System marking, RFID system

Handheld
RFMARK HF / UHF
Marking
UCT-PMLP ...
UCT-PMP ...

Page 280
Page 282
Page 284



Wireless exchange of printing data

MARKING system app and MINI FD BLUETOOTH

Page 288



Marking solutions with planning and marking software

Customer-specific printing service CLIP PROJECT ...

Page 290



Crimping tool, portable hand-held device

CRIMPHANDY 1.0 mm

Page 292



Customized tool sets and personalized tools

**TOOL ... CUS
CRIMPFIX ... CUS
WIREFOX ... CUS**

Page 296

Page 298

Page 301

Marking systems, tools, and mounting material

Optimize all of the processes involved in the setup, installation, and maintenance of your control cabinets and switchgear. We offer optimally coordinated products from our marking, tool, and mounting material ranges.



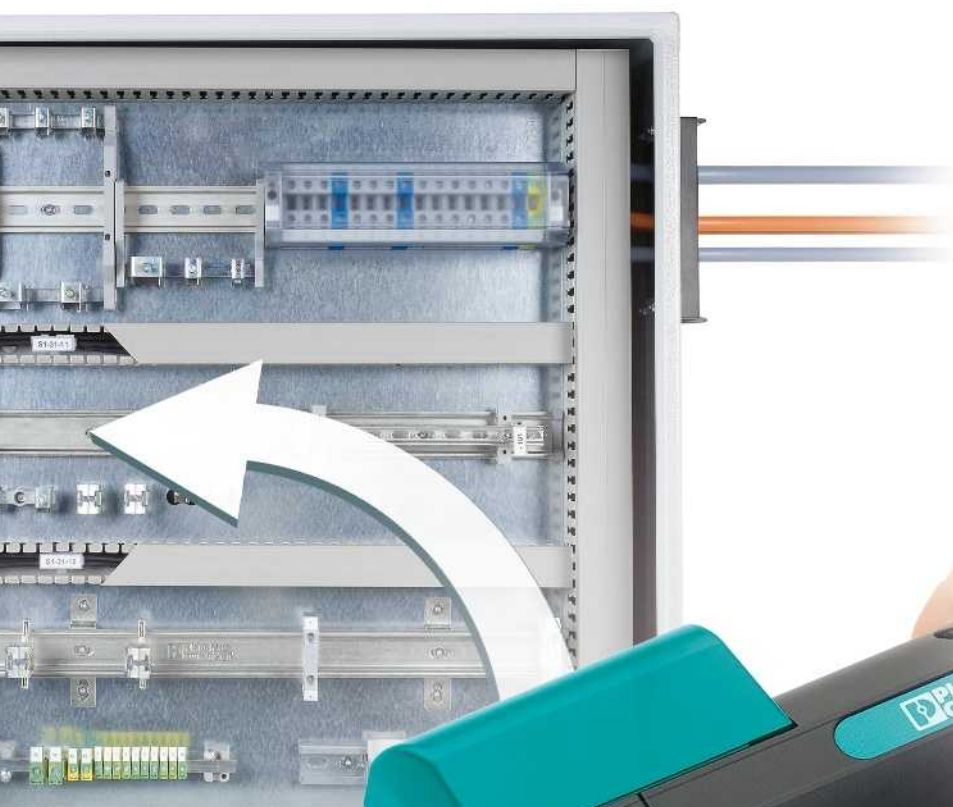

MARKING system

MARKING system provides the perfect solutions for terminal, conductor, cable, device, and system marking. It places at your disposal the CLIP PROJECT planning and marking software, various printing systems, and a wide variety of marking materials.

TOOL fox

TOOL fox is the complete range of professional processing and measuring tools. Designed for use in all processes in electrical engineering, the tools and automatic devices impress with their optimum handling and quality.



CABINET add-on

CABINET add-on stands for modern control cabinet technology. DIN rails and end brackets ensure the secure attachment of terminal blocks and modules, while shield connection clamps guarantee EMC-compliant wiring and cable ducts bring order to the control cabinet.

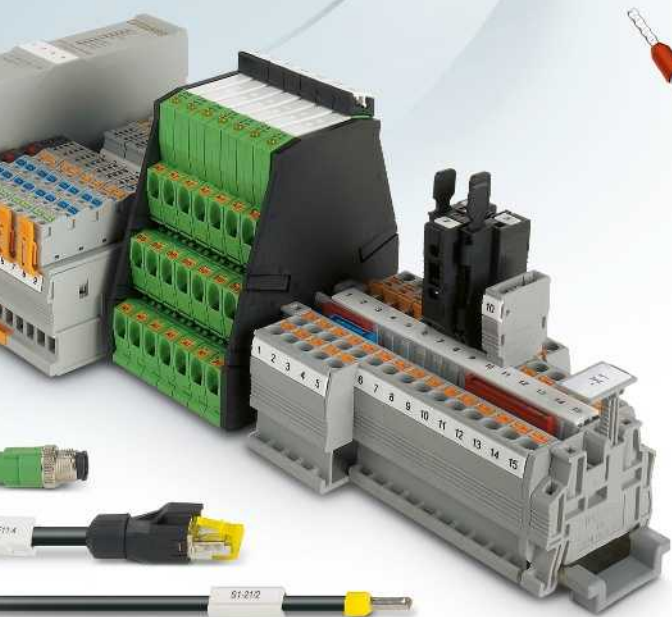

Service

Choose the complete range. Working to your specifications, we will manufacture and label terminal strips and complete terminal boxes or modules for direct installation in your application.

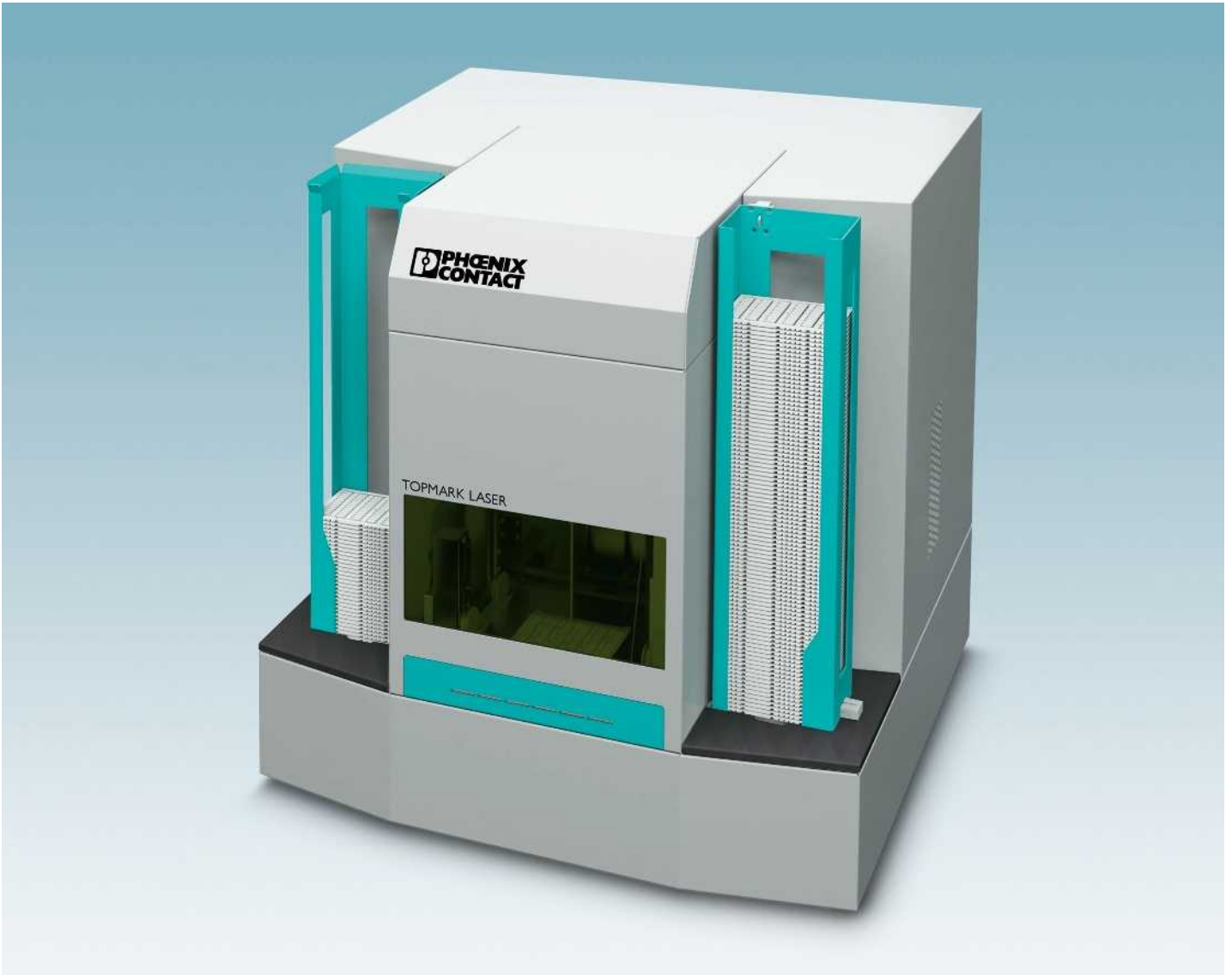

The TOPMARK LASER marking system provides you with the flexibility to implement the requirements of challenging industrial identification. With a comprehensive product range of over 400 markers for your terminal, conductor, cable, and device marking, you will find the ideal solution for your application.



The stainless steel material can be marked in two ways: through material removal (engraving) or annealing marking. The latter involves changing the color of the material while the material surface remains level.



You can easily mark all materials in the UCT product range with the automated material handling of the TOPMARK LASER. The laser marker automatically detects the material sheets fed in. This means that you can carry out marking quickly and effectively - without time-consuming parameter settings.

**TOPMARK LASER,
desktop laser marker
for card material and material sheets**



Direct laser marking

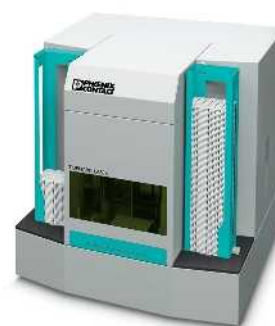

Integration in the CLIP PROJECT planning and marking software makes the TOPMARK LASER the fastest desktop laser marker in its class - and the easiest to use. You can now mark all materials without special knowledge of laser technology.

- Wide range of materials comprising stainless steel, aluminum, ABS, polyacrylics, and polycarbonate
- Preset optimized laser parameters are available for all material types
- Automatic material detection enables fast and effective marking
- The material sheet can be easily reused by creating a project code

| Dimensions | |
|----------------------------------|---|
| | [mm] |
| General data | |
| Temperature range | [°C] |
| Marking method | Direct laser marking |
| Laser system | Ytterbium fiber laser, pulsed, 1064 nm |
| Laser class | Laser class 1 according to EN 60825-1 classification |
| Interfaces | 10/100 Mbps Ethernet |
| Power supply | [V] |
| Weight | [kg] |
| Operating systems | MS Windows XP SP3, MS Windows Vista, MS Windows 7 (32/64-bit), MS Windows 8 (32/64-bit) |
| Power consumption | [W] |
| CW laser power (continuous wave) | [W] |

| Technical data | | |
|----------------|--------|--------|
| Width | Length | Height |
| 664 | 630 | 682 |

| Description | Color |
|---|-------|
| Laser marker and MARKING NOTEBOOK , incl. CLIP PROJECT professional software and installed drivers, user manual, sheet hopper, card hopper and 230 V extraction unit | |
| With German operating system and German keyboard | |

| Ordering data | | |
|---------------|-----------|-------------|
| Type | Order No. | Pcs. / Pkt. |
| TOPMARK LASER | 0831831 | 1 |

| |
|--|
| Carriage , for accommodating TOPMARK LASER, extraction unit, and MARKING NOTEBOOK |
| Sheet hopper , for TOPMARK LASER |
| Card hopper , for TOPMARK LASER |

| Accessories | | |
|-------------------------|-----------|-------------|
| Type | Order No. | Pcs. / Pkt. |
| TOPMARK LASER STATION | 0831835 | 1 |
| TOPMARK LASER-MAG SHEET | 0831836 | 1 |
| TOPMARK LASER-MAG CARD | 0831837 | 1 |

Marking material for TOPMARK LASER - MARKING system

Stainless steel and aluminum cable marking for assembly with cable binders



- The LS-WMTB ... product range is available in stainless steel (V4A) or aluminum and includes markers that can be quickly and easily fitted with cable binders
- The LS-WMTB-V4A ... group is particularly characterized by its high resistance to salt water, chloride, and solvents and it is therefore also suitable for the most demanding industrial requirements



- Automatic material detection enables fast and effective marking without time-consuming parameter settings
- The material sheet can be easily reused by creating a project code
- **Designation example:**
LS-WMTB-V4A (29x8)
Lettering field size: 29 x 8 mm



- The use of modern laser technology creates highly resistant and permanent marking, which can only be removed by destroying the material
- The LS-WMTB-V4A ... product group can be marked in two ways: by engraving or annealing
- Labeling service: Phoenix Contact can custom-label all markers according to your requirements

Can be marked using:



Direct laser marking

General data

Can be marked with
Material
Wipe resistance
Components

Description

Stainless steel label, for assembly with cable binders, conductor diameter
36-section, > 2.9 mm Ø
16-section, > 4.6 mm Ø
16-section, > 4.6 mm Ø
8-section, > 4.6 mm Ø

Aluminum label, for assembly with cable binders, conductor diameter
36-section, > 2.9 mm Ø
16-section, > 4.6 mm Ø
16-section, > 4.6 mm Ø
8-section, > 4.6 mm Ø

Stainless steel label, for assembly with cable binders, conductor diameter, **marked according to customer specifications¹⁾**
36-section, > 2.9 mm Ø
16-section, > 4.6 mm Ø
16-section, > 4.6 mm Ø
8-section, > 4.6 mm Ø

Aluminum label, for assembly with cable binders, conductor diameter, **marked according to customer specifications¹⁾**
36-section, > 2.9 mm Ø
16-section, > 4.6 mm Ø
16-section, > 4.6 mm Ø
8-section, > 4.6 mm Ø

Sheet hopper, for TOPMARK LASER

Notes:

For matching stainless steel cable binders, see page 580 in main catalog 5 or the product area on our website at phoenixcontact.net/products.

¹⁾ For an ordering example, see page 358 in main catalog 5.



Stainless steel, material thickness: 0.5 mm



Aluminum, material thickness: 0.8 mm



Aluminum, black, material thickness: 0.8 mm

| Technical data | | |
|---|-----------|-------------|
| TOPMARK LASER V4A DIN EN 61010-1 (VDE 0411-1) Free from silicone, halogen, and cadmium | | |
| Ordering data | | |
| Type | Order No. | Pcs. / Pkt. |
| LS-WMTB-V4A (29X8) | 0831516 | 5 |
| LS-WMTB-V4A (40X15) | 0831517 | 5 |
| LS-WMTB-V4A (60X15) | 0831518 | 5 |
| LS-WMTB-V4A (100X15) | 0831519 | 5 |
| LS-WMTB-V4A (29X8) CUS | 0831802 | 1 |
| LS-WMTB-V4A (40X15) CUS | 0831803 | 1 |
| LS-WMTB-V4A (60X15) CUS | 0831804 | 1 |
| LS-WMTB-V4A (100X15) CUS | 0831805 | 1 |
| Accessories | | |
| TOPMARK LASER-MAG SHEET | 0831836 | 1 |

| Technical data | | |
|--|-----------|-------------|
| TOPMARK LASER Aluminum DIN EN 61010-1 (VDE 0411-1) Free from silicone, halogen, and cadmium | | |
| Ordering data | | |
| Type | Order No. | Pcs. / Pkt. |
| LS-WMTB-AL (29X8) | 0831500 | 5 |
| LS-WMTB-AL (40X15) | 0831501 | 5 |
| LS-WMTB-AL (60X15) | 0831502 | 5 |
| LS-WMTB-AL (100X15) | 0831503 | 5 |
| LS-WMTB-AL (29X8) CUS | 0831786 | 1 |
| LS-WMTB-AL (40X15) CUS | 0831787 | 1 |
| LS-WMTB-AL (60X15) CUS | 0831788 | 1 |
| LS-WMTB-AL (100X15) CUS | 0831789 | 1 |
| Accessories | | |
| TOPMARK LASER-MAG SHEET | 0831836 | 1 |

| Technical data | | |
|--|-----------|-------------|
| TOPMARK LASER Aluminum DIN EN 61010-1 (VDE 0411-1) Free from silicone, halogen, and cadmium | | |
| Ordering data | | |
| Type | Order No. | Pcs. / Pkt. |
| LS-WMTB-AL (29X8) BK | 0831508 | 5 |
| LS-WMTB-AL (40X15) BK | 0831509 | 5 |
| LS-WMTB-AL (60X15) BK | 0831510 | 5 |
| LS-WMTB-AL (100X15) BK | 0831511 | 5 |
| LS-WMTB-AL (29X8) BK CUS | 0831794 | 1 |
| LS-WMTB-AL (40X15) BK CUS | 0831795 | 1 |
| LS-WMTB-AL (60X15) BK CUS | 0831796 | 1 |
| LS-WMTB-AL (100X15) BK CUS | 0831797 | 1 |
| Accessories | | |
| TOPMARK LASER-MAG SHEET | 0831836 | 1 |

Stainless steel and aluminum cable marking for assembly with cable binders



- The LS-WMTB ... product range in circular format is available in stainless steel (V4A) or aluminum and includes markers that can be quickly and easily fitted with cable binders
- The LS-WMTB-V4A ... group is particularly characterized by its high resistance to saltwater, chloride, and solvents and it is therefore also suitable for the most demanding industrial requirements



- Automatic material detection enables fast and effective marking without time-consuming parameter settings
- The material sheet can be easily reused by creating a project code
- **Designation example:**
LS-WMTB-V4A (D25)
Diameter: 25 mm



- The use of modern laser technology creates highly resistant and permanent marking, which can only be removed by destroying the material
- The LS-WMTB-V4A ... product group can be marked in two ways: by engraving or annealing
- Labeling service: Phoenix Contact can custom-label all markers according to your requirements

Can be marked using:



Direct laser marking

General data

Can be marked with
Material
Wipe resistance
Components

Description

Stainless steel label, round, for assembly with cable binders

30-section, diameter: 25 mm

20-section, diameter: 30 mm

Aluminum label, round, for assembly with cable binders

30-section, diameter: 25 mm

20-section, diameter: 30 mm

Stainless steel label, round, for assembly with cable binders, labeled according to customer specifications¹⁾

30-section, diameter: 25 mm

20-section, diameter: 30 mm

Aluminum label, round, for assembly with cable binders, labeled according to customer specifications¹⁾

30-section, diameter: 25 mm

20-section, diameter: 30 mm

Sheet hopper, for TOPMARK LASER

Notes:

For matching stainless steel cable binders, see page 580 in main catalog 5 or the product area on our website at phoenixcontact.net/products.

¹⁾ For an ordering example, see page 358 in main catalog 5.



Stainless steel, material thickness: 0.5 mm



Aluminum, material thickness: 0.8 mm



Aluminum, black, material thickness: 0.8 mm

| Technical data |
|---|
| TOPMARK LASER V4A DIN EN 61010-1 (VDE 0411-1) Free from silicone, halogen, and cadmium |

| Technical data |
|--|
| TOPMARK LASER Aluminum DIN EN 61010-1 (VDE 0411-1) Free from silicone, halogen, and cadmium |

| Technical data |
|--|
| TOPMARK LASER Aluminum DIN EN 61010-1 (VDE 0411-1) Free from silicone, halogen, and cadmium |

| Ordering data | | |
|--|--------------------|-------------|
| Type | Order No. | Pcs. / Pkt. |
| LS-WMTB-V4A (D25) LS-WMTB-V4A (D30) | 0831520 0831521 | 5 5 |
| LS-WMTB-V4A (D25) CUS LS-WMTB-V4A (D30) CUS | 0831806 0831807 | 1 1 |

| Ordering data | | |
|--|--------------------|-------------|
| Type | Order No. | Pcs. / Pkt. |
| LS-WMTB-AL (D25) LS-WMTB-AL (D30) | 0831504 0831505 | 5 5 |
| LS-WMTB-AL (D25) CUS LS-WMTB-AL (D30) CUS | 0831790 0831791 | 1 1 |

| Ordering data | | |
|--|--------------------|-------------|
| Type | Order No. | Pcs. / Pkt. |
| LS-WMTB-AL (D25) BK LS-WMTB-AL (D30) BK | 0831512 0831513 | 5 5 |
| LS-WMTB-AL (D25) BK CUS LS-WMTB-AL (D30) BK CUS | 0831798 0831799 | 1 1 |

| Accessories | | |
|-------------------------|---------|---|
| TOPMARK LASER-MAG SHEET | 0831836 | 1 |

| Accessories | | |
|-------------------------|---------|---|
| TOPMARK LASER-MAG SHEET | 0831836 | 1 |

| Accessories | | |
|-------------------------|---------|---|
| TOPMARK LASER-MAG SHEET | 0831836 | 1 |

Stainless steel and aluminum device marking for screwing or riveting



- The LS-EMSP ... product range is available in stainless steel (V4A) or aluminum and includes markers that can be quickly and easily fitted with screws or rivets
- The LS-EMSP-V4A ... group is particularly characterized by its high resistance to saltwater, chloride, and solvents and is therefore also suitable for the most demanding industrial requirements
- The LS-EMSP-V4A ... product group can be permanently marked in two ways: by engraving or annealing
- **Designation example: LS-EMSP-V4A (39x15)**
Lettering field size: 39 x 15 mm
- Labeling service: Phoenix Contact can custom-label all markers according to your requirements

Notes:

For matching rivets for securing the LS-EMSP-V4A ... and LS-EMSP-AL ..., see page 370 in main catalog 5 or the product area on our website at phoenixcontact.net/products.

For drilling diagrams, visit phoenixcontact.net/products.

1) For an ordering example, see page 358 in main catalog 5.

2) From lettering field size 110 x 80 to 170 x 180 mm, the material thickness is 1.5 mm.



Can be marked using:



Direct laser marking

PRINTED
FOR YOU



Stainless steel,
material thickness: 0.5 mm

General data

Can be marked with
Material
Wipe resistance
Components

Technical data

TOPMARK LASER
V4A
DIN EN 61010-1 (VDE 0411-1)
Free from silicone, halogen, and cadmium

Description

Marking label, with mounting holes 3.2 mm in diameter

24-section
16-section
10-section
6-section
2-section
2-section
2-section
1-section
1-section

Marking label, with mounting holes 3.2 mm in diameter

10-section, red
10-section, orange
10-section, blue
10-section, green
6-section, red
6-section, orange
6-section, blue
6-section, green

Marking label, with mounting holes 3.2 mm in diameter, marked according to customer specifications¹⁾

24-section
16-section
10-section
6-section
2-section
2-section
2-section
1-section
1-section

Marking label, with mounting holes 3.2 mm in diameter, marked according to customer specifications¹⁾

10-section, red
10-section, orange
10-section, blue
10-section, green
6-section, red
6-section, orange
6-section, blue
6-section, green

Sheet hopper, for TOPMARK LASER

Ordering data

| Type | Order No. | Pcs. / Pkt. |
|---------------------------|-----------|-------------|
| LS-EMSP-V4A (39X15) | 0831653 | 5 |
| LS-EMSP-V4A (50X15) | 0831654 | 5 |
| LS-EMSP-V4A (50X30) | 0831655 | 5 |
| LS-EMSP-V4A (75,6X54) | 0831656 | 5 |
| LS-EMSP-V4A (90X60) | 0831657 | 5 |
| LS-EMSP-V4A (39X15) CUS | 0831939 | 1 |
| LS-EMSP-V4A (50X15) CUS | 0831940 | 1 |
| LS-EMSP-V4A (50X30) CUS | 0831941 | 1 |
| LS-EMSP-V4A (75,6X54) CUS | 0831942 | 1 |
| LS-EMSP-V4A (90X60) CUS | 0831943 | 1 |

Accessories

| | | |
|-------------------------|---------|---|
| TOPMARK LASER-MAG SHEET | 0831836 | 1 |
|-------------------------|---------|---|



Aluminum,
material thickness: 0.8 mm²)



Aluminum, black,
material thickness: 0.8 mm²)



Aluminum, colored,
material thickness: 0.8 mm

| Technical data | | |
|--|-----------|-------------|
| TOPMARK LASER Aluminum DIN EN 61010-1 (VDE 0411-1) Free from silicone, halogen, and cadmium | | |
| Ordering data | | |
| Type | Order No. | Pcs. / Pkt. |
| LS-EMSP-AL (39X15) | 0831615 | 5 |
| LS-EMSP-AL (50X15) | 0831616 | 5 |
| LS-EMSP-AL (50X30) | 0831617 | 5 |
| LS-EMSP-AL (75,6X54) | 0831618 | 5 |
| LS-EMSP-AL (90X60) | 0831619 | 5 |
| LS-EMSP-AL (110X80) | 0831620 | 5 |
| LS-EMSP-AL (150X80) | 0831621 | 5 |
| LS-EMSP-AL (150X120) | 0831622 | 5 |
| LS-EMSP-AL (170X180) | 0831623 | 5 |
| | | |
| LS-EMSP-AL (39X15) CUS | 0831901 | 1 |
| LS-EMSP-AL (50X15) CUS | 0831902 | 1 |
| LS-EMSP-AL (50X30) CUS | 0831903 | 1 |
| LS-EMSP-AL (75,6X54) CUS | 0831904 | 1 |
| LS-EMSP-AL (90X60) CUS | 0831905 | 1 |
| LS-EMSP-AL (110X80) CUS | 0831906 | 1 |
| LS-EMSP-AL (150X80) CUS | 0831907 | 1 |
| LS-EMSP-AL (150X120) CUS | 0831908 | 1 |
| LS-EMSP-AL (170X180) CUS | 0831909 | 1 |
| Accessories | | |
| TOPMARK LASER-MAG SHEET | 0831836 | 1 |

| Technical data | | |
|--|-----------|-------------|
| TOPMARK LASER Aluminum DIN EN 61010-1 (VDE 0411-1) Free from silicone, halogen, and cadmium | | |
| Ordering data | | |
| Type | Order No. | Pcs. / Pkt. |
| LS-EMSP-AL (39X15) BK | 0831626 | 5 |
| LS-EMSP-AL (50X15) BK | 0831627 | 5 |
| LS-EMSP-AL (50X30) BK | 0831628 | 5 |
| LS-EMSP-AL (75,6X54) BK | 0831629 | 5 |
| LS-EMSP-AL (90X60) BK | 0831630 | 5 |
| LS-EMSP-AL (110X80) BK | 0831631 | 5 |
| LS-EMSP-AL (150X80) BK | 0831632 | 5 |
| LS-EMSP-AL (150X120) BK | 0831633 | 5 |
| LS-EMSP-AL (170X180) BK | 0831634 | 5 |
| | | |
| LS-EMSP-AL (39X15) BK CUS | 0831912 | 1 |
| LS-EMSP-AL (50X15) BK CUS | 0831913 | 1 |
| LS-EMSP-AL (50X30) BK CUS | 0831914 | 1 |
| LS-EMSP-AL (75,6X54) BK CUS | 0831915 | 1 |
| LS-EMSP-AL (90X60) BK CUS | 0831916 | 1 |
| LS-EMSP-AL (110X80) BK CUS | 0831917 | 1 |
| LS-EMSP-AL (150X80) BK CUS | 0831918 | 1 |
| LS-EMSP-AL (150X120) BK CUS | 0831919 | 1 |
| LS-EMSP-AL (170X180) BK CUS | 0831920 | 1 |
| Accessories | | |
| TOPMARK LASER-MAG SHEET | 0831836 | 1 |

| Technical data | | |
|--|-----------|-------------|
| TOPMARK LASER Aluminum DIN EN 61010-1 (VDE 0411-1) Free from silicone, halogen, and cadmium | | |
| Ordering data | | |
| Type | Order No. | Pcs. / Pkt. |
| LS-EMSP-AL (50X30) RD | 0831637 | 5 |
| LS-EMSP-AL (50X30) OG | 0831641 | 5 |
| LS-EMSP-AL (50X30) BU | 0831645 | 5 |
| LS-EMSP-AL (50X30) GN | 0831649 | 5 |
| LS-EMSP-AL (75,6X54) RD | 0831638 | 5 |
| LS-EMSP-AL (75,6X54) OG | 0831642 | 5 |
| LS-EMSP-AL (75,6X54) BU | 0831646 | 5 |
| LS-EMSP-AL (75,6X54) GN | 0831650 | 5 |
| | | |
| LS-EMSP-AL (50X30) RD CUS | 0831923 | 1 |
| LS-EMSP-AL (50X30) OG CUS | 0831927 | 1 |
| LS-EMSP-AL (50X30) BU CUS | 0831931 | 1 |
| LS-EMSP-AL (50X30) GN CUS | 0831935 | 1 |
| LS-EMSP-AL (75,6X54) RD CUS | 0831924 | 1 |
| LS-EMSP-AL (75,6X54) OG CUS | 0831928 | 1 |
| LS-EMSP-AL (75,6X54) BU CUS | 0831932 | 1 |
| LS-EMSP-AL (75,6X54) GN CUS | 0831936 | 1 |
| Accessories | | |
| TOPMARK LASER-MAG SHEET | 0831836 | 1 |

Adhesive aluminum device marking

Can be marked using:



Direct laser marking



Aluminum,
material thickness: 0.8 mm

- The aluminum LS-EMLP-AL ... product range includes self-adhesive device markers with a high adhesive strength
- The use of modern laser technology creates highly resistant and permanent marking, which can only be removed by destroying the material
- Automatic material detection enables fast and effective marking without time-consuming parameter settings
- The material sheet can be easily reused by creating a project code
- **Designation example:**
LS-EMLP-AL (27x15)
Lettering field size: 27 x 15 mm
- Labeling service: Phoenix Contact can custom-label all markers according to your requirements

Notes:

1) For an ordering example, see page 358 in main catalog 5.

General data

Can be marked with
Material
Wipe resistance
Components

Technical data

TOPMARK LASER
Aluminum
DIN EN 61010-1 (VDE 0411-1)
Free from silicone, halogen, and cadmium

Description

Marking label, aluminum, self-adhesive

- 40-section
- 35-section
- 24-section
- 16-section
- 10-section
- 6-section
- 2-section

Marking label, aluminum, self-adhesive

- 10-section, red
- 10-section, orange
- 10-section, blue
- 10-section, green
- 6-section, red
- 6-section, orange
- 6-section, blue
- 6-section, green

Marking label, aluminum, self-adhesive, marked according to customer specifications¹⁾

- 40-section
- 35-section
- 24-section
- 16-section
- 10-section
- 6-section
- 2-section

Marking label, aluminum, self-adhesive, marked according to customer specifications¹⁾

- 10-section, red
- 10-section, orange
- 10-section, blue
- 10-section, green
- 6-section, red
- 6-section, orange
- 6-section, blue
- 6-section, green

Ordering data

| Type | Order No. | Pcs. / Pkt. |
|--------------------------|-----------|-------------|
| LS-EMLP-AL (27X15) | 0831580 | 5 |
| LS-EMLP-AL (27X18) | 0831581 | 5 |
| LS-EMLP-AL (49X15) | 0831582 | 5 |
| LS-EMLP-AL (60X15) | 0831583 | 5 |
| LS-EMLP-AL (60X30) | 0831584 | 5 |
| LS-EMLP-AL (85,6X54) | 0831585 | 5 |
| LS-EMLP-AL (100X60) | 0831586 | 5 |
| LS-EMLP-AL (27X15) CUS | 0831866 | 1 |
| LS-EMLP-AL (27X18) CUS | 0831867 | 1 |
| LS-EMLP-AL (49X15) CUS | 0831868 | 1 |
| LS-EMLP-AL (60X15) CUS | 0831869 | 1 |
| LS-EMLP-AL (60X30) CUS | 0831870 | 1 |
| LS-EMLP-AL (85,6X54) CUS | 0831871 | 1 |
| LS-EMLP-AL (100X60) CUS | 0831872 | 1 |



Sheet hopper, for TOPMARK LASER

Accessories

| | | |
|-------------------------|---------|---|
| TOPMARK LASER-MAG SHEET | 0831836 | 1 |
|-------------------------|---------|---|

PRINTED
FOR YOU



Aluminum, black,
material thickness: 0.8 mm

PRINTED
FOR YOU



Aluminum, colored,
material thickness: 0.8 mm

| Technical data | | |
|--|-----------|-------------|
| TOPMARK LASER | | |
| Aluminum | | |
| DIN EN 61010-1 (VDE 0411-1) | | |
| Free from silicone, halogen, and cadmium | | |
| Ordering data | | |
| Type | Order No. | Pcs. / Pkt. |
| LS-EMLP-AL (27X15) BK | 0831589 | 5 |
| LS-EMLP-AL (27X18) BK | 0831590 | 5 |
| LS-EMLP-AL (49X15) BK | 0831591 | 5 |
| LS-EMLP-AL (60X15) BK | 0831592 | 5 |
| LS-EMLP-AL (60X30) BK | 0831593 | 5 |
| LS-EMLP-AL (85,6X54) BK | 0831594 | 5 |
| LS-EMLP-AL (100X60) BK | 0831595 | 5 |
| LS-EMLP-AL (27X15) BK CUS | 0831875 | 1 |
| LS-EMLP-AL (27X18) BK CUS | 0831876 | 1 |
| LS-EMLP-AL (49X15) BK CUS | 0831877 | 1 |
| LS-EMLP-AL (60X15) BK CUS | 0831878 | 1 |
| LS-EMLP-AL (60X30) BK CUS | 0831879 | 1 |
| LS-EMLP-AL (85,6X54) BK CUS | 0831880 | 1 |
| LS-EMLP-AL (100X60) BK CUS | 0831881 | 1 |

| Technical data | | |
|--|-----------|-------------|
| TOPMARK LASER | | |
| Aluminum | | |
| DIN EN 61010-1 (VDE 0411-1) | | |
| Free from silicone, halogen, and cadmium | | |
| Ordering data | | |
| Type | Order No. | Pcs. / Pkt. |
| LS-EMLP-AL (60X30) RD | 0831598 | 5 |
| LS-EMLP-AL (60X30) OG | 0831602 | 5 |
| LS-EMLP-AL (60X30) BU | 0831606 | 5 |
| LS-EMLP-AL (60X30) GN | 0831610 | 5 |
| LS-EMLP-AL (85,6X54) RD | 0831599 | 5 |
| LS-EMLP-AL (85,6X54) OG | 0831603 | 5 |
| LS-EMLP-AL (85,6X54) BU | 0831607 | 5 |
| LS-EMLP-AL (85,6X54) GN | 0831611 | 5 |
| LS-EMLP-AL (60X30) RD CUS | 0831884 | 1 |
| LS-EMLP-AL (60X30) OG CUS | 0831888 | 1 |
| LS-EMLP-AL (60X30) BU CUS | 0831892 | 1 |
| LS-EMLP-AL (60X30) GN CUS | 0831896 | 1 |
| LS-EMLP-AL (85,6X54) RD CUS | 0831885 | 1 |
| LS-EMLP-AL (85,6X54) OG CUS | 0831889 | 1 |
| LS-EMLP-AL (85,6X54) BU CUS | 0831893 | 1 |
| LS-EMLP-AL (85,6X54) GN CUS | 0831897 | 1 |

| Accessories | | |
|-------------------------|---------|---|
| TOPMARK LASER-MAG SHEET | 0831836 | 1 |

| Accessories | | |
|-------------------------|---------|---|
| TOPMARK LASER-MAG SHEET | 0831836 | 1 |

Aluminum device marking for snapping into marker carriers

Can be marked using:



Direct laser marking



Aluminum, material thickness: 0.8 mm

- The aluminum LS-EMP-AL ... product range includes markers that can be quickly and easily fitted into existing CARRIER-EMP ... label frames
- The use of modern laser technology creates highly resistant and permanent marking, which can only be removed by destroying the material
- Automatic material detection enables fast and effective marking without time-consuming parameter settings
- The material sheet can be easily reused by creating a project code
- **Designation example:**
LS-EMP-AL (27x15)
Lettering field size: 27 x 15 mm
- Labeling service: Phoenix Contact can custom-label all markers according to your requirements

Notes:

1) For an ordering example, see page 358 in main catalog 5.

General data

Can be marked with
Material
Wipe resistance
Components

Description

Marking label, aluminum, can be snapped into marker carriers

- 40-section
- 35-section
- 24-section
- 16-section
- 10-section
- 6-section
- 2-section

Marking label, aluminum, can be snapped into marker carriers, marked according to customer specifications¹⁾

- 40-section
- 35-section
- 24-section
- 16-section
- 10-section
- 6-section
- 2-section

Sheet hopper, for TOPMARK LASER

Marker carriers, for snap-in labels

- Marker size: 27 x 15 mm
- Marker size: 49 x 15 mm
- Marker size: 60 x 15 mm
- Marker size: 60 x 30 mm
- Marker size: 85 x 54 mm

Marker carriers, for snap-in labels, for buttons and switches 22 mm in diameter

- Marker size: 27 x 15 mm
- Marker size: 27 x 18 mm



Technical data

TOPMARK LASER
Aluminum
DIN EN 61010-1 (VDE 0411-1)
Free from silicone, halogen, and cadmium

Ordering data

| Type | Order No. | Pcs. / Pkt. |
|-------------------------|-----------|-------------|
| LS-EMP-AL (27X15) | 0831661 | 5 |
| LS-EMP-AL (27X18) | 0831662 | 5 |
| LS-EMP-AL (49X15) | 0831663 | 5 |
| LS-EMP-AL (60X15) | 0831664 | 5 |
| LS-EMP-AL (60X30) | 0831665 | 5 |
| LS-EMP-AL (85,6X54) | 0831666 | 5 |
| LS-EMP-AL (100X60) | 0831667 | 5 |
| LS-EMP-AL (27X15) CUS | 0831947 | 1 |
| LS-EMP-AL (27X18) CUS | 0831948 | 1 |
| LS-EMP-AL (49X15) CUS | 0831949 | 1 |
| LS-EMP-AL (60X15) CUS | 0831950 | 1 |
| LS-EMP-AL (60X30) CUS | 0831951 | 1 |
| LS-EMP-AL (85,6X54) CUS | 0831952 | 1 |
| LS-EMP-AL (100X60) CUS | 0831953 | 1 |

Accessories

| | | |
|-------------------------|---------|----|
| TOPMARK LASER-MAG SHEET | 0831836 | 1 |
| CARRIER-EMP (27X15) | 0827451 | 80 |
| CARRIER-EMP (49X15) | 0827452 | 40 |
| CARRIER-EMP (60X15) | 0827453 | 40 |
| CARRIER-EMP (60X30) | 0827454 | 30 |
| CARRIER-EMP (85,6X54) | 0829365 | 10 |
| CARRIER-EMP 22 (27X15) | 0827447 | 50 |
| CARRIER-EMP 22 (27X18) | 0827448 | 50 |

PRINTED
 FOR YOU



Aluminum, black, material thickness: 0.8 mm

Technical data

TOPMARK LASER
 Aluminum
 DIN EN 61010-1 (VDE 0411-1)
 Free from silicone, halogen, and cadmium

Ordering data

| Type | Order No. | Pcs. / Pkt. |
|----------------------------|-----------|-------------|
| LS-EMP-AL (27X15) BK | 0831669 | 5 |
| LS-EMP-AL (27X18) BK | 0831670 | 5 |
| LS-EMP-AL (49X15) BK | 0831671 | 5 |
| LS-EMP-AL (60X15) BK | 0831672 | 5 |
| LS-EMP-AL (60X30) BK | 0831673 | 5 |
| LS-EMP-AL (85,6X54) BK | 0831674 | 5 |
| LS-EMP-AL (100X60) BK | 0831675 | 5 |
| LS-EMP-AL (27X15) BK CUS | 0831955 | 1 |
| LS-EMP-AL (27X18) BK CUS | 0831956 | 1 |
| LS-EMP-AL (49X15) BK CUS | 0831957 | 1 |
| LS-EMP-AL (60X15) BK CUS | 0831958 | 1 |
| LS-EMP-AL (60X30) BK CUS | 0831959 | 1 |
| LS-EMP-AL (85,6X54) BK CUS | 0831960 | 1 |
| LS-EMP-AL (100X60) BK CUS | 0831961 | 1 |

Accessories

| | | |
|-------------------------|---------|----|
| TOPMARK LASER-MAG SHEET | 0831836 | 1 |
| CARRIER-EMP (27X15) | 0827451 | 80 |
| CARRIER-EMP (49X15) | 0827452 | 40 |
| CARRIER-EMP (60X15) | 0827453 | 40 |
| CARRIER-EMP (60X30) | 0827454 | 30 |
| CARRIER-EMP (85,6X54) | 0829365 | 10 |
| CARRIER-EMP 22 (27X15) | 0827447 | 50 |
| CARRIER-EMP 22 (27X18) | 0827448 | 50 |

Plastic adhesive device marking

Can be marked using:



Direct laser marking

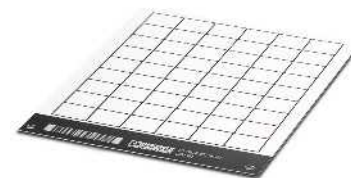

White, material thickness: 0.8 mm

- The LS-EMLP ... product range includes self-adhesive double-layer plastic device markers
- A wide range of different marker sizes is available for custom designs
- Automatic material detection enables fast and effective marking without time-consuming parameter settings
- The material sheet can be easily reused by creating a project code
- **Designation example:**
LS-EMLP (11x9) SR
Lettering field size: 11 x 9 mm, silver material with black marking

| General data | |
|--------------------|--------------------------------|
| Can be marked with | TOPMARK LASER |
| Material | TRANSPLY-ABS |
| Temperature range | -20 ... 85 [°C] |
| Wipe resistance | DIN EN 61010-1 (VDE 0411-1) |
| Components | Free from silicone and halogen |

| Technical data | |
|--------------------------------|--|
| TOPMARK LASER | |
| TRANSPLY-ABS | |
| -20 ... 85 [°C] | |
| DIN EN 61010-1 (VDE 0411-1) | |
| Free from silicone and halogen | |

| Ordering data | |
|----------------------|---|
| Description | Plastic label sheet, self-adhesive, double-layer plastic labels |
| 1 sheet = 255 labels | |
| 1 sheet = 221 labels | |
| 1 sheet = 220 labels | |
| 1 sheet = 170 labels | |
| 1 sheet = 130 labels | |
| 1 sheet = 100 labels | |
| 1 sheet = 176 labels | |
| 1 sheet = 160 labels | |
| 1 sheet = 104 labels | |
| 1 sheet = 56 labels | |
| 1 sheet = 120 labels | |
| 1 sheet = 78 labels | |
| 1 sheet = 60 labels | |
| 1 sheet = 54 labels | |
| 1 sheet = 36 labels | |
| 1 sheet = 33 labels | |
| 1 sheet = 30 labels | |
| 1 sheet = 30 labels | |
| 1 sheet = 20 labels | |
| 1 sheet = 10 labels | |
| 1 sheet = 6 labels | |
| 1 sheet = 2 labels | |

| Ordering data | | |
|----------------------|-----------|-------------|
| Type | Order No. | Pcs. / Pkt. |
| LS-EMLP (11X9) WH | 0831678 | 10 |
| LS-EMLP (13X9) WH | 0831679 | 10 |
| LS-EMLP (17X7) WH | 0831680 | 10 |
| LS-EMLP (17X9) WH | 0831681 | 10 |
| LS-EMLP (17,5X12) WH | 0831682 | 10 |
| LS-EMLP (17,5X15) WH | 0831683 | 10 |
| LS-EMLP (20X7) WH | 0831684 | 10 |
| LS-EMLP (20X8) WH | 0831685 | 10 |
| LS-EMLP (22X12) WH | 0831686 | 10 |
| LS-EMLP (22X22) WH | 0831687 | 10 |
| LS-EMLP (27X8) WH | 0831688 | 10 |
| LS-EMLP (27X12,5) WH | 0831689 | 10 |
| LS-EMLP (27X15) WH | 0831690 | 10 |
| LS-EMLP (27X18) WH | 0831691 | 10 |
| LS-EMLP (27X27) WH | 0831692 | 10 |
| LS-EMLP (45X14) WH | 0831693 | 10 |
| LS-EMLP (45X15) WH | 0831694 | 10 |
| LS-EMLP (49X15) WH | 0831695 | 10 |
| LS-EMLP (60X15) WH | 0831696 | 10 |
| LS-EMLP (60X30) WH | 0831697 | 10 |
| LS-EMLP (85,6X54) WH | 0831698 | 10 |
| LS-EMLP (100X60) WH | 0831699 | 10 |

| Accessories | |
|---------------------------------|--|
| Sheet hopper, for TOPMARK LASER | |

| Accessories | | |
|-------------------------|---------|---|
| TOPMARK LASER-MAG SHEET | 0831836 | 1 |
| | | |

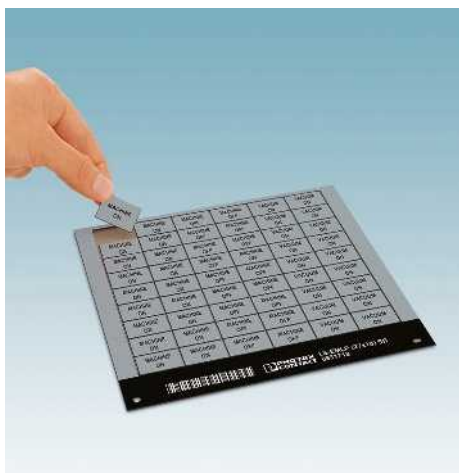



Yellow, material thickness: 0.8 mm



Silver, material thickness: 0.8 mm

| Technical data |
|--------------------------------|
| TOPMARK LASER |
| TRANSPLY-ABS |
| -20 ... 85 |
| DIN EN 61010-1 (VDE 0411-1) |
| Free from silicone and halogen |

| Technical data |
|--------------------------------|
| TOPMARK LASER |
| TRANSPLY-ABS |
| -20 ... 85 |
| DIN EN 61010-1 (VDE 0411-1) |
| Free from silicone and halogen |

| Ordering data | | |
|----------------------|-----------|-------------|
| Type | Order No. | Pcs. / Pkt. |
| LS-EMLP (11X9) YE | 0831732 | 10 |
| LS-EMLP (13X9) YE | 0831733 | 10 |
| LS-EMLP (17X7) YE | 0831734 | 10 |
| LS-EMLP (17X9) YE | 0831735 | 10 |
| LS-EMLP (17,5X12) YE | 0831736 | 10 |
| LS-EMLP (17,5X15) YE | 0831737 | 10 |
| LS-EMLP (20X7) YE | 0831738 | 10 |
| LS-EMLP (20X8) YE | 0831739 | 10 |
| LS-EMLP (22X12) YE | 0831740 | 10 |
| LS-EMLP (22X22) YE | 0831741 | 10 |
| LS-EMLP (27X8) YE | 0831742 | 10 |
| LS-EMLP (27X12,5) YE | 0831743 | 10 |
| LS-EMLP (27X15) YE | 0831744 | 10 |
| LS-EMLP (27X18) YE | 0831745 | 10 |
| LS-EMLP (27X27) YE | 0831746 | 10 |
| LS-EMLP (45X14) YE | 0831747 | 10 |
| LS-EMLP (45X15) YE | 0831748 | 10 |
| LS-EMLP (49X15) YE | 0831749 | 10 |
| LS-EMLP (60X15) YE | 0831750 | 10 |
| LS-EMLP (60X30) YE | 0831751 | 10 |
| LS-EMLP (85,6X54) YE | 0831752 | 10 |
| LS-EMLP (100X60) YE | 0831753 | 10 |

| Ordering data | | |
|----------------------|-----------|-------------|
| Type | Order No. | Pcs. / Pkt. |
| LS-EMLP (11X9) SR | 0831705 | 10 |
| LS-EMLP (13X9) SR | 0831706 | 10 |
| LS-EMLP (17X7) SR | 0831707 | 10 |
| LS-EMLP (17X9) SR | 0831708 | 10 |
| LS-EMLP (17,5X12) SR | 0831709 | 10 |
| LS-EMLP (17,5X15) SR | 0831710 | 10 |
| LS-EMLP (20X7) SR | 0831711 | 10 |
| LS-EMLP (20X8) SR | 0831712 | 10 |
| LS-EMLP (22X12) SR | 0831713 | 10 |
| LS-EMLP (22X22) SR | 0831714 | 10 |
| LS-EMLP (27X8) SR | 0831715 | 10 |
| LS-EMLP (27X12,5) SR | 0831716 | 10 |
| LS-EMLP (27X15) SR | 0831717 | 10 |
| LS-EMLP (27X18) SR | 0831718 | 10 |
| LS-EMLP (27X27) SR | 0831719 | 10 |
| LS-EMLP (45X14) SR | 0831720 | 10 |
| LS-EMLP (45X15) SR | 0831721 | 10 |
| LS-EMLP (49X15) SR | 0831722 | 10 |
| LS-EMLP (60X15) SR | 0831723 | 10 |
| LS-EMLP (60X30) SR | 0831724 | 10 |
| LS-EMLP (85,6X54) SR | 0831725 | 10 |
| LS-EMLP (100X60) SR | 0831726 | 10 |

| Accessories | | |
|-------------------------|-----------|-------------|
| Type | Order No. | Pcs. / Pkt. |
| TOPMARK LASER-MAG SHEET | 0831836 | 1 |

| Accessories | | |
|-------------------------|-----------|-------------|
| Type | Order No. | Pcs. / Pkt. |
| TOPMARK LASER-MAG SHEET | 0831836 | 1 |

Plastic adhesive device marking, marked according to customer specifications



- The LS-EMLP ... product range includes self-adhesive double-layer plastic device markers
- A wide range of different marker sizes is available for custom designs
- Automatic material detection enables fast and effective marking without time-consuming parameter settings
- The material sheet can be easily reused by creating a project code
- **Designation example:**
LS-EMLP (11x9) SR CUS
Lettering field size: 11 x 9 mm, silver material with black marking
- Labeling service: Phoenix Contact can custom-label all markers according to your requirements

Notes:

1) For an ordering example, see page 358 in main catalog 5.

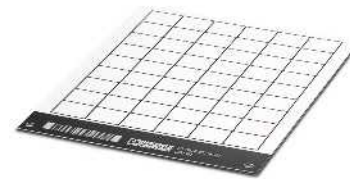

White, material thickness: 0.8 mm

| General data | |
|-------------------|-------------------|
| Material | |
| Temperature range | [-20 ... 85] [°C] |
| Wipe resistance | |
| Components | |

| Technical data | |
|-------------------|--------------------------------|
| Material | TRANSPLY-ABS |
| Temperature range | -20 ... 85 |
| Wipe resistance | DIN EN 61010-1 (VDE 0411-1) |
| Components | Free from silicone and halogen |

| Description | |
|--|--|
| Plastic label sheet, self-adhesive double-layer plastic labels, marked according to customer specifications¹⁾ | |
| 1 sheet = 255 labels | |
| 1 sheet = 221 labels | |
| 1 sheet = 220 labels | |
| 1 sheet = 170 labels | |
| 1 sheet = 130 labels | |
| 1 sheet = 100 labels | |
| 1 sheet = 176 labels | |
| 1 sheet = 160 labels | |
| 1 sheet = 104 labels | |
| 1 sheet = 56 labels | |
| 1 sheet = 120 labels | |
| 1 sheet = 78 labels | |
| 1 sheet = 60 labels | |
| 1 sheet = 54 labels | |
| 1 sheet = 36 labels | |
| 1 sheet = 33 labels | |
| 1 sheet = 30 labels | |
| 1 sheet = 30 labels | |
| 1 sheet = 20 labels | |
| 1 sheet = 10 labels | |
| 1 sheet = 6 labels | |
| 1 sheet = 2 labels | |

| Ordering data | | |
|--------------------------|-----------|-------------|
| Type | Order No. | Pcs. / Pkt. |
| LS-EMLP (11X9) WH CUS | 0831964 | 1 |
| LS-EMLP (13X9) WH CUS | 0831965 | 1 |
| LS-EMLP (17X7) WH CUS | 0831966 | 1 |
| LS-EMLP (17X9) WH CUS | 0831967 | 1 |
| LS-EMLP (17,5X12) WH CUS | 0831968 | 1 |
| LS-EMLP (17,5X15) WH CUS | 0831969 | 1 |
| LS-EMLP (20X7) WH CUS | 0831970 | 1 |
| LS-EMLP (20X8) WH CUS | 0831971 | 1 |
| LS-EMLP (22X12) WH CUS | 0831972 | 1 |
| LS-EMLP (22X22) WH CUS | 0831973 | 1 |
| LS-EMLP (27X8) WH CUS | 0831974 | 1 |
| LS-EMLP (27X12,5) WH CUS | 0831975 | 1 |
| LS-EMLP (27X15) WH CUS | 0831976 | 1 |
| LS-EMLP (27X18) WH CUS | 0831977 | 1 |
| LS-EMLP (27X27) WH CUS | 0831978 | 1 |
| LS-EMLP (45X14) WH CUS | 0831979 | 1 |
| LS-EMLP (45X15) WH CUS | 0831980 | 1 |
| LS-EMLP (49X15) WH CUS | 0831981 | 1 |
| LS-EMLP (60X15) WH CUS | 0831982 | 1 |
| LS-EMLP (60X30) WH CUS | 0831983 | 1 |
| LS-EMLP (85,6X54) WH CUS | 0831984 | 1 |
| LS-EMLP (100X60) WH CUS | 0831985 | 1 |

| Sheet hopper, for TOPMARK LASER | |
|---------------------------------|---------|
| TOPMARK LASER-MAG SHEET | 0831836 |

| Accessories | | |
|-------------------------|---------|---|
| TOPMARK LASER-MAG SHEET | 0831836 | 1 |

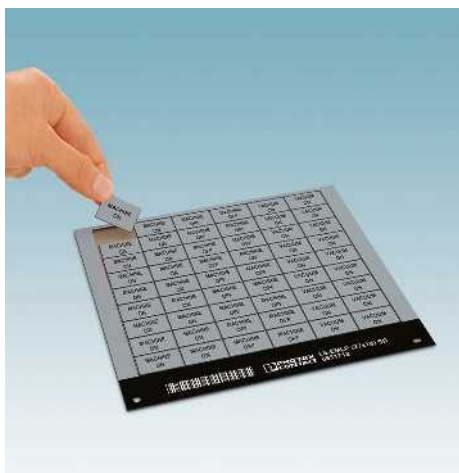

PRINTED
FOR YOU

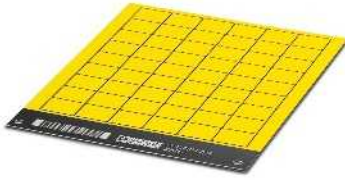

Yellow, material thickness: 0.8 mm

PRINTED
FOR YOU



Silver, material thickness: 0.8 mm

| Technical data |
|--------------------------------|
| TRANSPLY-ABS |
| -20 ... 85 |
| DIN EN 61010-1 (VDE 0411-1) |
| Free from silicone and halogen |

| Ordering data | | |
|--------------------------|-----------|-------------|
| Type | Order No. | Pcs. / Pkt. |
| LS-EMLP (11X9) YE CUS | 0832018 | 1 |
| LS-EMLP (13X9) YE CUS | 0832019 | 1 |
| LS-EMLP (17X7) YE CUS | 0832020 | 1 |
| LS-EMLP (17X9) YE CUS | 0832021 | 1 |
| LS-EMLP (17,5X12) YE CUS | 0832022 | 1 |
| LS-EMLP (17,5X15) YE CUS | 0832023 | 1 |
| LS-EMLP (20X7) YE CUS | 0832024 | 1 |
| LS-EMLP (20X8) YE CUS | 0832025 | 1 |
| LS-EMLP (22X12) YE CUS | 0832026 | 1 |
| LS-EMLP (22X22) YE CUS | 0832027 | 1 |
| LS-EMLP (27X8) YE CUS | 0832028 | 1 |
| LS-EMLP (27X12,5) YE CUS | 0832029 | 1 |
| LS-EMLP (27X15) YE CUS | 0832030 | 1 |
| LS-EMLP (27X18) YE CUS | 0832031 | 1 |
| LS-EMLP (27X27) YE CUS | 0832032 | 1 |
| LS-EMLP (45X14) YE CUS | 0832033 | 1 |
| LS-EMLP (45X15) YE CUS | 0832034 | 1 |
| LS-EMLP (49X15) YE CUS | 0832035 | 1 |
| LS-EMLP (60X15) YE CUS | 0832036 | 1 |
| LS-EMLP (60X30) YE CUS | 0832037 | 1 |
| LS-EMLP (85,6X54) YE CUS | 0832038 | 1 |
| LS-EMLP (100X60) YE CUS | 0832039 | 1 |

| Accessories | | |
|-------------------------|---------|---|
| TOPMARK LASER-MAG SHEET | 0831836 | 1 |

| Technical data |
|--------------------------------|
| TRANSPLY-ABS |
| -20 ... 85 |
| DIN EN 61010-1 (VDE 0411-1) |
| Free from silicone and halogen |

| Ordering data | | |
|--------------------------|-----------|-------------|
| Type | Order No. | Pcs. / Pkt. |
| LS-EMLP (11X9) SR CUS | 0831991 | 1 |
| LS-EMLP (13X9) SR CUS | 0831992 | 1 |
| LS-EMLP (17X7) SR CUS | 0831993 | 1 |
| LS-EMLP (17X9) SR CUS | 0831994 | 1 |
| LS-EMLP (17,5X12) SR CUS | 0831995 | 1 |
| LS-EMLP (17,5X15) SR CUS | 0831996 | 1 |
| LS-EMLP (20X7) SR CUS | 0831997 | 1 |
| LS-EMLP (20X8) SR CUS | 0831998 | 1 |
| LS-EMLP (22X12) SR CUS | 0831999 | 1 |
| LS-EMLP (22X22) SR CUS | 0832000 | 1 |
| LS-EMLP (27X8) SR CUS | 0832001 | 1 |
| LS-EMLP (27X12,5) SR CUS | 0832002 | 1 |
| LS-EMLP (27X15) SR CUS | 0832003 | 1 |
| LS-EMLP (27X18) SR CUS | 0832004 | 1 |
| LS-EMLP (27X27) SR CUS | 0832005 | 1 |
| LS-EMLP (45X14) SR CUS | 0832006 | 1 |
| LS-EMLP (45X15) SR CUS | 0832007 | 1 |
| LS-EMLP (49X15) SR CUS | 0832008 | 1 |
| LS-EMLP (60X15) SR CUS | 0832009 | 1 |
| LS-EMLP (60X30) SR CUS | 0832010 | 1 |
| LS-EMLP (85,6X54) SR CUS | 0832011 | 1 |
| LS-EMLP (100X60) SR CUS | 0832012 | 1 |

| Accessories | | |
|-------------------------|---------|---|
| TOPMARK LASER-MAG SHEET | 0831836 | 1 |

Plastic adhesive device marking, with hole for switch

Can be marked using:



Direct laser marking



Diameter: 24 mm, material thickness: 0.8 mm

- The LS-EMLP 24/ 30/ 32 ... product range includes self-adhesive double-layer plastic device markers with a hole for the switch
- A wide range of different marker sizes is available for custom designs
- Automatic material detection enables fast and effective marking without time-consuming parameter settings
- The material sheet can be easily reused by creating a project code
- **Designation example:**
LS-EMLP 24 (30x12) WH
Lettering field size: 30 x 12 mm
Hole diameter for switch: 24 mm, white material with black marking
- Labeling service: Phoenix Contact can custom-label all markers according to your requirements

Notes:
1) For an ordering example, see page 358 in main catalog 5.



| General data | |
|--------------------|--------------------------------|
| Can be marked with | TOPMARK LASER |
| Material | TRANSPLY-ABS |
| Temperature range | -20 ... 85 [°C] |
| Wipe resistance | DIN EN 61010-1 (VDE 0411-1) |
| Components | Free from silicone and halogen |

| Technical data | | |
|----------------|--|--|
|----------------|--|--|

| Description | Color |
|-------------|-------|
|-------------|-------|

Plastic label sheet, with hole for switch, diameter 24 mm, self-adhesive double-layer plastic labels

| | |
|---------------------|--------|
| 1 sheet = 20 labels | white |
| 1 sheet = 20 labels | yellow |
| 1 sheet = 20 labels | silver |

Plastic label sheet, with hole for switch, diameter 30 mm, self-adhesive double-layer plastic labels

| | |
|--------------------|--------|
| 1 sheet = 9 labels | white |
| 1 sheet = 9 labels | yellow |
| 1 sheet = 9 labels | silver |

Plastic label sheet, with hole for switch, diameter 32 mm, self-adhesive double-layer plastic labels

| | |
|---------------------|--------|
| 1 sheet = 12 labels | white |
| 1 sheet = 12 labels | yellow |
| 1 sheet = 12 labels | silver |

Plastic label sheet, with hole for switch, diameter 24 mm, self-adhesive double-layer plastic labels, **marked according to customer specifications¹⁾**

| | |
|---------------------|--------|
| 1 sheet = 20 labels | white |
| 1 sheet = 20 labels | yellow |
| 1 sheet = 20 labels | silver |

Plastic label sheet, with hole for switch, diameter 30 mm, self-adhesive double-layer plastic labels, **marked according to customer specifications¹⁾**

| | |
|--------------------|--------|
| 1 sheet = 9 labels | white |
| 1 sheet = 9 labels | yellow |
| 1 sheet = 9 labels | silver |

Plastic label sheet, with hole for switch, diameter 32 mm, self-adhesive double-layer plastic labels, **marked according to customer specifications¹⁾**

| | |
|---------------------|--------|
| 1 sheet = 12 labels | white |
| 1 sheet = 12 labels | yellow |
| 1 sheet = 12 labels | silver |

| Ordering data | | |
|---------------|--|--|
|---------------|--|--|

| Type | Order No. | Pcs. / Pkt. |
|---------------------------|-----------|-------------|
| LS-EMLP 24 (30X12) WH | 0831700 | 10 |
| LS-EMLP 24 (30X12) YE | 0831754 | 10 |
| LS-EMLP 24 (30X12) SR | 0831727 | 10 |
| LS-EMLP 24 (30X12) WH CUS | 0831986 | 1 |
| LS-EMLP 24 (30X12) YE CUS | 0832040 | 1 |
| LS-EMLP 24 (30X12) SR CUS | 0832013 | 1 |

| Sheet hopper, for TOPMARK LASER | | |
|---------------------------------|--|--|
|---------------------------------|--|--|

| Accessories | | |
|-------------|--|--|
|-------------|--|--|

| | | |
|-------------------------|---------|---|
| TOPMARK LASER-MAG SHEET | 0831836 | 1 |
|-------------------------|---------|---|

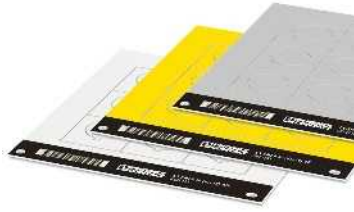

Diameter: 30 mm,
 material thickness: 0.8 mm



Diameter: 32 mm,
 material thickness: 0.8 mm

| Technical data |
|--|
| TOPMARK LASER TRANSPLY-ABS -20 ... 85 DIN EN 61010-1 (VDE 0411-1) Free from silicone and halogen |

| Technical data |
|--|
| TOPMARK LASER TRANSPLY-ABS -20 ... 85 DIN EN 61010-1 (VDE 0411-1) Free from silicone and halogen |

| Ordering data |
|---------------|
|---------------|

| Ordering data |
|---------------|
|---------------|

| Type | Order No. | Pcs. / Pkt. |
|---------------------------|-----------|-------------|
| LS-EMLP 30 (45X10) WH | 0831701 | 10 |
| LS-EMLP 30 (45X10) YE | 0831755 | 10 |
| LS-EMLP 30 (45X10) SR | 0831728 | 10 |
| | | |
| LS-EMLP 30 (45X10) WH CUS | 0831987 | 1 |
| LS-EMLP 30 (45X10) YE CUS | 0832041 | 1 |
| LS-EMLP 30 (45X10) SR CUS | 0832014 | 1 |

| Type | Order No. | Pcs. / Pkt. |
|---------------------------|-----------|-------------|
| LS-EMLP 32 (38X14) WH | 0831702 | 10 |
| LS-EMLP 32 (38X14) YE | 0831756 | 10 |
| LS-EMLP 32 (38X14) SR | 0831729 | 10 |
| | | |
| LS-EMLP 32 (38X14) WH CUS | 0831988 | 1 |
| LS-EMLP 32 (38X14) YE CUS | 0832042 | 1 |
| LS-EMLP 32 (38X14) SR CUS | 0832015 | 1 |

| Accessories | | |
|-------------------------|---------|---|
| TOPMARK LASER-MAG SHEET | 0831836 | 1 |

| Accessories | | |
|-------------------------|---------|---|
| TOPMARK LASER-MAG SHEET | 0831836 | 1 |

Laser foil adhesive device marking

Can be marked using:



Direct laser marking

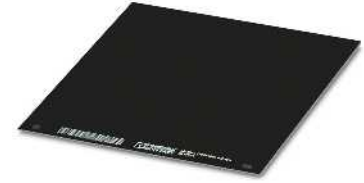

Black-white

- The LS-EML ... product range includes self-adhesive, double-layer plastic foil labels that can be custom designed
- The laser foil is characterized by its high heat resistance and particularly strong adhesive properties
- Automatic material detection enables fast and effective marking without time-consuming parameter settings
- The material sheet can be easily reused by creating a project code
- **Designation example:**
LS-EML (180x180) BK-WH
Lettering field size: 180 x 180 mm, can be custom designed, black material with white marking
- Labeling service: Phoenix Contact can custom-label all markers according to your requirements

General data

| | |
|--------------------|--------------------|
| Can be marked with | |
| Material | |
| Temperature range | [-40 ... 300] [°C] |
| Wipe resistance | |
| Components | |

Description

Laser foil, double-layer plastic foil, for custom label design

Lettering field size: 180 x 180 mm

Laser foil, double-layer plastic foil, for custom label design, marked according to customer specifications¹⁾

Lettering field size: 180 x 180 mm

Sheet hopper, for TOPMARK LASER

Technical data

| |
|--------------------------------|
| TOPMARK LASER |
| Polyacrylate |
| -40 ... 300 |
| DIN EN 61010-1 (VDE 0411-1) |
| Free from silicone and halogen |

Ordering data

| Type | Order No. | Pcs. / Pkt. |
|----------------------------|-----------|-------------|
| LS-EML (180X180) BK-WH | 0831784 | 10 |
| LS-EML (180X180) BK-WH CUS | 0832070 | 1 |

Accessories

| Accessories | Order No. | Pcs. / Pkt. |
|-------------------------|-----------|-------------|
| TOPMARK LASER-MAG SHEET | 0831836 | 1 |

Notes:

¹⁾ For an ordering example, see page 358 in main catalog 5.



Terminal marking - MARKING system

UM marking for terminals from other manufacturers, strips

Can be marked using:



Thermal transfer for sheets and cards



UV LED technology



Plotter



For a tall marker groove



- The universal UM1-TM ... material marking range includes markers for Weidmüller, Conta-Clip, Klemsan, Wago, and ABB (Entrelec) terminal blocks
- The markers, which are supplied in double strips, can be quickly and easily marked with BLUEMARK ..., THERMOMARK CARD ..., and the CMS-P1-PLOTTER
- The markers support multiline labeling
- The marking strips are easy to fit and can be easily separated if required
- The marking strips are snapped into the magazine in a twist-proof manner by means of a coding pin and fed to the output devices
- The format automatically ensures printing with a high level of positional accuracy

General data

Can be marked with

Material

Inflammability class according to UL 94

Temperature range

[°C]

Wipe resistance

Components

Technical data

THERMOMARK CARD PLUS • THERMOMARK CARD • BLUEMARK CLED • CMS-P1-PLOTTER

PC

V2

-40 ... 120

DIN EN 61010-1 (VDE 0411-1)

Free from silicone, halogen, and cadmium

Ordering data

| Description | Color | Type | Order No. | Pcs. / Pkt. |
|--|-------|------------------------|----------------|-------------|
| UM1-TM ... , for marking terminal blocks from other manufacturers, Weidmüller, Conta-Clip, Klemsan | | | | |
| 34-section, lettering field size: 3.5 x 12 mm, pitch: 3.5 mm | white | UM1-TM (3,5X12) | 0830925 | 10 |
| 24-section, lettering field size: 5 x 10 mm, pitch: 5 mm | white | UM1-TM (5X10) | 0830905 | 10 |
| 24-section, lettering field size: 5 x 12 mm, pitch: 5 mm | white | UM1-TM (5X12) | 0830912 | 10 |
| 20-section, lettering field size: 6 x 10 mm, pitch: 6 mm | white | UM1-TM (6X10) | 0830903 | 10 |
| 20-section, lettering field size: 6 x 12 mm, pitch: 6 mm | white | UM1-TM (6X12) | 0830909 | 10 |
| 14-section, lettering field size: 8 x 10 mm, pitch: 8 mm | white | UM1-TM (8X10) | 0830906 | 10 |
| 14-section, lettering field size: 8 x 12 mm, pitch: 8 mm | white | UM1-TM (8X12) | 0830920 | 10 |
| 10-section, lettering field size: 12 x 10 mm, pitch: 12 mm | white | UM1-TM (12X10) | 0830916 | 10 |
| UM1U-TM ... , for marking terminal blocks from other manufacturers, Weidmüller, Conta-Clip, Klemsan, with an offset foot | | | | |
| 24-section, lettering field size: 5 x 10 mm, pitch: 5 mm | white | | | |
| 20-section, lettering field size: 6 x 10 mm, pitch: 6 mm | white | | | |
| UM1-TMF ... , for marking terminal blocks from other manufacturers, Weidmüller, Conta-Clip, Klemsan, Wago, ABB (Entrelec) | | | | |
| 34-section, lettering field size: 3.5 x 5 mm, pitch: 3.5 mm | white | | | |
| 24-section, lettering field size: 5 x 5 mm, pitch: 5 mm | white | | | |
| 20-section, lettering field size: 6 x 5 mm, pitch: 6 mm | white | | | |
| 14-section, lettering field size: 8 x 5 mm, pitch: 8 mm | white | | | |
| Magazine , for THERMOMARK CARD ... | | | | |
| for accommodating UM1-TM ... | | | | |
| for accommodating UM1U-TM ... | | | | |
| for accommodating UM1-TMF ... | | | | |
| Accessories | | | | |
| THERMOMARK CARD-UM-MAG1 | | | 0831200 | 1 |



For a tall marker groove, with an offset foot



For a flat marker groove

Technical data

THERMOMARK CARD PLUS • THERMOMARK CARD •
 BLUEMARK CLED • CMS-P1-PLOTTER
 PC
 V2
 -40 ... 120
 DIN EN 61010-1 (VDE 0411-1)
 Free from silicone, halogen, and cadmium

Technical data

THERMOMARK CARD PLUS • THERMOMARK CARD •
 BLUEMARK CLED • CMS-P1-PLOTTER
 PC
 V2
 -40 ... 120
 DIN EN 61010-1 (VDE 0411-1)
 Free from silicone, halogen, and cadmium

Ordering data

| Type | Order No. | Pcs. / Pkt. |
|----------------|-----------|-------------|
| UM1U-TM (5X10) | 0830910 | 10 |
| UM1U-TM (6X10) | 0830907 | 10 |

Ordering data

| Type | Order No. | Pcs. / Pkt. |
|-----------------|-----------|-------------|
| UM1-TMF (3,5X5) | 0830935 | 10 |
| UM1-TMF (5X5) | 0830902 | 10 |
| UM1-TMF (6X5) | 0830904 | 10 |
| UM1-TMF (8X5) | 0830924 | 10 |

Accessories

| | | |
|-------------------------|---------|---|
| THERMOMARK CARD-UM-MAG4 | 0831203 | 1 |
|-------------------------|---------|---|

Accessories

| | | |
|-------------------------|---------|---|
| THERMOMARK CARD-UM-MAG3 | 0831202 | 1 |
|-------------------------|---------|---|

Terminal marking - MARKING system

Terminal marking, marker strips for tall and flat marker grooves



Can be marked using:



Thermal transfer for rolls

PRINTED
FOR YOU



Unlabeled or labeled according to customer specifications

- The TMT labeling range includes markers for all products with tall and flat marker grooves
- Labeling service: Phoenix Contact can custom-label all TMT markers in accordance with your requirements

Notes:
 1) For an ordering example, see page 358 in main catalog 5.
 2) The TMT TOOL snap-in tool can only be used for terminal blocks from Phoenix Contact.

General data

| | |
|---|------|
| Can be marked with | |
| Material | |
| Material strength | |
| Inflammability class according to UL 94 | |
| Temperature range | [°C] |
| Wipe resistance | |
| Components | |

Technical data

| |
|--|
| THERMOMARK ROLL • THERMOMARK ROLL X1 • THERMOMARK X1.1 • THERMOMARK X1.2 • THERMOMARK S1.1 |
| PVC |
| 0.50 mm |
| V0 |
| -30 ... 80 |
| DIN EN 61010-1 (VDE 0411-1) |
| Free from silicone and cadmium |

Ordering data

| Description | Color |
|--|-------|
| Insert strips, unprinted, 1 roll = 50 m, continuous | |
| Strip height: 5.5 mm | white |
| Strip height: 6.2 mm | white |
| Strip height: 6.5 mm | white |
| Strip height: 7.5 mm | white |
| Strip height: 8 mm | white |
| Strip height: 8.5 mm | white |
| Strip height: 9.5 mm | white |
| Strip height: 10 mm | white |
| Strip height: 10.5 mm | white |
| Strip height: 11 mm | white |
| Strip height: 12 mm | white |
| Insert strips, marked according to customer specifications¹⁾ | |
| Strip height: 5.5 mm | white |
| Strip height: 6.2 mm | white |
| Strip height: 6.5 mm | white |
| Strip height: 7.5 mm | white |
| Strip height: 8 mm | white |
| Strip height: 8.5 mm | white |
| Strip height: 9.5 mm | white |
| Strip height: 10 mm | white |
| Strip height: 10.5 mm | white |
| Strip height: 11 mm | white |
| Strip height: 12 mm | white |

| Type | Order No. | Pcs. / Pkt. |
|-------------------|-----------|-------------|
| TMT (EX5,5)R | 0803062 | 1 |
| TMT (EX6,2)R | 0803063 | 1 |
| TMT (EX6,5)R | 0803064 | 1 |
| TMT (EX7,5)R | 0803065 | 1 |
| TMT (EX8)R | 0803066 | 1 |
| TMT (EX8,5)R | 0803067 | 1 |
| TMT (EX9,5)R | 0828295 | 1 |
| TMT (EX10)R | 0803068 | 1 |
| TMT (EX10,5)R | 0803070 | 1 |
| TMT2 (EX11)R | 0802683 | 1 |
| TMT (EX12)R | 0803071 | 1 |
| TMT (EX5,5)R CUS | 0803072 | 1 |
| TMT (EX6,2)R CUS | 0803073 | 1 |
| TMT (EX6,5)R CUS | 0803075 | 1 |
| TMT (EX7,5)R CUS | 0803076 | 1 |
| TMT (EX8)R CUS | 0803077 | 1 |
| TMT (EX8,5)R CUS | 0803078 | 1 |
| TMT (EX9,5)R CUS | 0803079 | 1 |
| TMT (EX10)R CUS | 0803080 | 1 |
| TMT (EX10,5)R CUS | 0803081 | 1 |
| TMT2 (EX11)R CUS | 0830811 | 1 |
| TMT (EX12)R CUS | 0803082 | 1 |

| | |
|---|--------|
| Locking tool to snap into the TMT... materials ²⁾ | orange |
|---|--------|

Accessories

| | | |
|-----------------|---------|---|
| TMT TOOL | 0816650 | 1 |
|-----------------|---------|---|

TMT ... terminal marking for terminal blocks from Phoenix Contact and other manufacturers



| | TMT (EX5,5)R | TMT (EX6,2)R | TMT (EX6,5)R | TMT (EX7,5)R | TMT (EX8)R | TMT (EX8,5)R | TMT (EX9,5)R | TMT (EX10)R | TMT (EX10,5)R | TMT2 (EX11)R | TMT (EX12)R |
|------------------------------|--------------|--------------|--------------|--------------|------------|--------------|--------------|-------------|---------------|--------------|-------------|
| TMT- markers, roll | 0803062 | 0803063 | 0803064 | 0803065 | 0803066 | 0803067 | 0828295 | 0803068 | 0803070 | 0802683 | 0803071 |
| Strip height | 5.5 | 6.2 | 6.5 | 7.5 | 8 | 8.5 | 9.5 | 10 | 10.5 | 10.8 | 12 |
| Terminal manufacturer | | | | | | | | | | | |
| Phoenix Contact | | | | | | | | | | | |
| Fuji Electronics Industry | | | | | | | | | | | |
| IDEC | | | | | | | | | | | |
| KASUGA | | | | | | | | | | | |
| TOGI | | | | | | | | | | | |
| WAGO (2001 ...- 2016 ...) | | | | | | | | | | | |
| Yoshida Electronics | | | | | | | | | | | |

Conductor and cable marking - MARKING system

Clip-on UniCard conductor marking

Can be marked using:



Thermal transfer for sheets and cards



UV LED technology



Direct laser marking

PRINTED
FOR YOU



32 markers
for conductor diameters of 2 to 2.9 mm

- The UCT-WMCO ... UniCard marking range includes markers for the subsequent marking of conductors by clipping on
- Secure tight fit even in the event of vibrations
- The markers, which are supplied in uniform sheets, can be marked quickly and easily with the TOPMARK LASER, THERMOMARK CARD PLUS, and the BLUEMARK... printers
- The format automatically ensures printing with a high level of positional accuracy
- Large-surface labeling in a space-saving design
- The sheets provide space for including function texts
- Labeling service: Phoenix Contact can custom-label all UniCard markers in accordance with your requirements

General data

| | |
|---|--------------------|
| Can be marked with | |
| Number of individual labels | |
| Number of individual labels per strip | |
| Material | |
| Inflammability class according to UL 94 | |
| Temperature range | [°C] |
| Wipe resistance | |
| Components | |
| Conductor diameter range | [mm] |
| Conductor cross section range | [mm ²] |

Technical data

| |
|---|
| THERMOMARK CARD PLUS • THERMOMARK CARD • BLUEMARK CLED • BLUEMARK LED • TOPMARK LASER |
| 32 |
| 8 |
| PC |
| V0 |
| -40 ... 120 |
| DIN EN 61010-1 (VDE 0411-1) |
| Free from silicone, halogen, and cadmium |
| 2 ... 2.9 |
| 0.5 ... 1.5 |

| Description | Color |
|---|-------|
| UniCard, for subsequent labeling of conductors | |
| Lettering field size: 12 x 4 mm | white |
| Lettering field size: 18 x 4 mm | white |
| UniCard, for subsequent labeling of conductors, labeled acc. to customer specifications ¹⁾ | |
| Lettering field size: 12 x 4 mm | white |
| Lettering field size: 18 x 4 mm | white |

Ordering data

| Type | Order No. | Pcs. / Pkt. |
|-------------------------|-----------|-------------|
| UCT-WMCO 2,9 (12X4) | 0830780 | 9 |
| UCT-WMCO 2,9 (18X4) | 0830781 | 9 |
| UCT-WMCO 2,9 (12X4) CUS | 0830788 | 1 |
| UCT-WMCO 2,9 (18X4) CUS | 0830789 | 1 |

Magazine, for THERMOMARK CARD ..., for accommodating: UCT-WMCO ...

Accessories

| | | |
|---------------------------|---------|---|
| THERMOMARK CARD-UCT-MAG25 | 0802935 | 1 |
|---------------------------|---------|---|

Notes:

¹⁾ For an ordering example, see page 358 in main catalog 5.





32 markers
for conductor diameters of 2.9 to 3.5 mm



32 markers
for conductor diameters of 3.5 to 4.1 mm



32 markers
for conductor diameters of 4.1 to 4.7 mm

| Technical data |
|---|
| THERMOMARK CARD PLUS • THERMOMARK CARD • BLUEMARK CLED • BLUEMARK LED • TOPMARK LASER |
| 32 |
| 8 |
| PC |
| V0 |
| -40 ... 120 |
| DIN EN 61010-1 (VDE 0411-1) |
| Free from silicone, halogen, and cadmium |
| 2.9 ... 3.5 |
| 1.5 ... 2.5 |

| Technical data |
|---|
| THERMOMARK CARD PLUS • THERMOMARK CARD • BLUEMARK CLED • BLUEMARK LED • TOPMARK LASER |
| 32 |
| 8 |
| PC |
| V0 |
| -40 ... 120 |
| DIN EN 61010-1 (VDE 0411-1) |
| Free from silicone, halogen, and cadmium |
| 3.5 ... 4.1 |
| 2.5 ... 4 |

| Technical data |
|---|
| THERMOMARK CARD PLUS • THERMOMARK CARD • BLUEMARK CLED • BLUEMARK LED • TOPMARK LASER |
| 32 |
| 8 |
| PC |
| V0 |
| -40 ... 120 |
| DIN EN 61010-1 (VDE 0411-1) |
| Free from silicone, halogen, and cadmium |
| 4.1 ... 4.7 |
| 2.5 ... 6 |

| Ordering data | | |
|-------------------------|-----------|-------------|
| Type | Order No. | Pcs. / Pkt. |
| UCT-WMCO 3,5 (12X4) | 0830782 | 7 |
| UCT-WMCO 3,5 (18X4) | 0830783 | 7 |
| UCT-WMCO 3,5 (12X4) CUS | 0830790 | 1 |
| UCT-WMCO 3,5 (18X4) CUS | 0830791 | 1 |

| Ordering data | | |
|-------------------------|-----------|-------------|
| Type | Order No. | Pcs. / Pkt. |
| UCT-WMCO 4,1 (12X4) | 0830784 | 7 |
| UCT-WMCO 4,1 (18X4) | 0830785 | 7 |
| UCT-WMCO 4,1 (12X4) CUS | 0830792 | 1 |
| UCT-WMCO 4,1 (18X4) CUS | 0830793 | 1 |

| Ordering data | | |
|-------------------------|-----------|-------------|
| Type | Order No. | Pcs. / Pkt. |
| UCT-WMCO 4,7 (12X4) | 0830786 | 6 |
| UCT-WMCO 4,7 (18X4) | 0830787 | 6 |
| UCT-WMCO 4,7 (12X4) CUS | 0830794 | 1 |
| UCT-WMCO 4,7 (18X4) CUS | 0830795 | 1 |

| Accessories | | |
|---------------------------|---------|---|
| THERMOMARK CARD-UCT-MAG25 | 0802935 | 1 |

| Accessories | | |
|---------------------------|---------|---|
| THERMOMARK CARD-UCT-MAG25 | 0802935 | 1 |

| Accessories | | |
|---------------------------|---------|---|
| THERMOMARK CARD-UCT-MAG25 | 0802935 | 1 |

Conductor and cable marking - MARKING system

UniCard cable marking for assembly with cable binders



Can be marked using:



Thermal transfer for sheets and cards



UV LED technology



Direct laser marking

PRINTED
FOR YOU



15 markers for conductor diameter > 5 mm

- The UCT-WMTBA ... UniCard marking range includes markers that can be secured using standard cable binders
- The markers, which are supplied in uniform sheets, can be marked quickly, easily, and accurately with the TOPMARK LASER, THERMOMARK CARD, THERMOMARK CARD PLUS, and BLUEMARK CLED
- The format automatically ensures printing with a high level of positional accuracy
- For large-surface marking of conductors and cables > 5 mm in diameter
- The sheets provide space for including function texts
- Thanks to their angular shape the markers fit perfectly onto cables
- Labeling service: Phoenix Contact can custom-label all UniCard markers in accordance with your requirements

General data

| | |
|---|------|
| Can be marked with | |
| Number of individual labels | |
| Number of individual labels per strip | |
| Material | |
| Inflammability class according to UL 94 | |
| Temperature range | [°C] |
| Components | |
| Cable diameter range | [mm] |

Technical data

| |
|---|
| THERMOMARK CARD PLUS • THERMOMARK CARD • BLUEMARK CLED • BLUEMARK LED • TOPMARK LASER |
| 15 |
| 5 |
| PC |
| V0 |
| -40 ... 120 |
| Free from silicone, halogen, and cadmium |
| > 5 |

| Description | Color |
|---|--------|
| UniCard , for assembly with cable binders | |
| Lettering field size: 24 x 4 mm | white |
| | yellow |
| Lettering field size: 29 x 6 mm | white |
| | yellow |
| Lettering field size: 40 x 17 mm | white |
| | yellow |
| UniCard , for assembly with cable binders, labeled acc. to customer specifications ¹⁾ | |
| Lettering field size: 24 x 4 mm | white |
| | yellow |
| Lettering field size: 29 x 6 mm | white |
| | yellow |
| Lettering field size: 40 x 17 mm | white |
| | yellow |

Ordering data

| Type | Order No. | Pcs. / Pkt. |
|-------------------------|-----------|-------------|
| UCT-WMTBA (24X4) | 1014082 | 10 |
| UCT-WMTBA (24X4) YE | 1014083 | 10 |
| UCT-WMTBA (24X4) CUS | 1014088 | 1 |
| UCT-WMTBA (24X4) YE CUS | 1014089 | 1 |

Notes:

For cable binders up to 5 mm wide.

For matching cable binders, see page 574 onwards in main catalog 5 or the product area on our website at phoenixcontact.net/products.

¹⁾ For an ordering example, see page 358 in main catalog 5.

Magazine, for THERMOMARK CARD ... for accommodating: UCT-WMTBA ...

Accessories

| Accessories | Order No. | Pcs. / Pkt. |
|---------------------------|-----------|-------------|
| THERMOMARK CARD-UCT-MAG27 | 0802989 | 1 |



12 markers
for conductor diameter > 6 mm



3 markers
for conductor diameter > 6 mm

Technical data

THERMOMARK CARD PLUS • THERMOMARK CARD •
 BLUEMARK CLED • BLUEMARK LED • TOPMARK LASER
 12
 4
 PC
 V0
 -40 ... 120
 Free from silicone, halogen, and cadmium
 > 6

Technical data

THERMOMARK CARD PLUS • THERMOMARK CARD •
 BLUEMARK CLED • BLUEMARK LED • TOPMARK LASER
 3
 1
 PC
 V0
 -40 ... 120
 Free from silicone, halogen, and cadmium
 > 6

Ordering data

| Type | Order No. | Pcs. / Pkt. |
|-------------------------|-----------|-------------|
| UCT-WMTBA (29X6) | 1014084 | 10 |
| UCT-WMTBA (29X6) YE | 1014085 | 10 |
| UCT-WMTBA (29X6) CUS | 1014090 | 1 |
| UCT-WMTBA (29X6) YE CUS | 1014091 | 1 |

Ordering data

| Type | Order No. | Pcs. / Pkt. |
|--------------------------|-----------|-------------|
| UCT-WMTBA (40X17) | 1014086 | 10 |
| UCT-WMTBA (40X17) YE | 1014087 | 10 |
| UCT-WMTBA (40X17) CUS | 1014092 | 1 |
| UCT-WMTBA (40X17) YE CUS | 1014093 | 1 |

Accessories

| | | |
|---------------------------|---------|---|
| THERMOMARK CARD-UCT-MAG27 | 0802989 | 1 |
|---------------------------|---------|---|

Accessories

| | | |
|---------------------------|---------|---|
| THERMOMARK CARD-UCT-MAG27 | 0802989 | 1 |
|---------------------------|---------|---|

Conductor and cable marking - MARKING system

Plastic cable markers for insert labels, for assembly with cable binders



- KMK HP ... plastic cable markers for marking and bundling conductors and cables indoors
- Inflammability class V0 acc. to UL 94
- The KMK HP... cable markers are particularly suitable for use in the railway industry, traffic technology, and building technology thanks to their outstanding material properties
- The KMK... versions have eyelets and are attached with cable binders
- The printed insert label is protected from dirt by the sealing cap
- Labeling service: Phoenix Contact can custom-label all insert labels for plastic cable markers in accordance with your requirements



Notes:

For matching cable binders, see page 574 onwards in main catalog 5 or the product area on our website at phoenixcontact.net/products.



Lettering field size: 25 x 6 mm, for cable diameter > 6 mm

General data

| | |
|---|------------------|
| Material | PC |
| Inflammability class according to UL 94 | V0 |
| Temperature range | -40 ... 125 [°C] |
| Components | Halogen-free |

| Description | Color |
|---|-------------|
| Cable marker carrier for cable binder assembly | transparent |

UniCard, insert strip for KMK... cable marker carriers, can be marked with THERMOMARK CARD... and BLUEMARK CLED

Lettering field size: 25 x 6 mm, 15-section
 Lettering field size: 29 x 8 mm, 15-section
 Lettering field size: 60 x 15 mm, 3-section
 Lettering field size: 40 x 17 mm, 3-section

UniCard, insert strips for KMK... cable marker carriers, **marked according to customer specifications**

Lettering field size: 25 x 6 mm, 15-section
 Lettering field size: 29 x 8 mm, 15-section
 Lettering field size: 40 x 17 mm, 3-section
 Lettering field size: 60 x 15 mm, 3-section

UniSheet, 0.5 mm thick, inflammability class V0 according to UL 94
 84-section, lettering field size: 25 x 6 mm
 48-section, lettering field size: 29 x 8 mm
 9-section, lettering field size: 60 x 15 mm
 16-section, lettering field size: 40 x 17 mm

Insert labels for thermal transfer printer, halogen-free

Lettering field size: 25 x 6 mm, 5000 labels per roll

Lettering field size: 29 x 8 mm, 5400 labels per roll

Lettering field size: 60 x 15 mm, 2500 labels per roll

Lettering field size: 40 x 17 mm, 2300 labels per roll

Cable binder, inflammability class according to UL 94: V0, halogen-free, temperature range: -40°C ... 85 °C, maximum bundle Ø [mm]/minimum tensile strength [N]

35 / 130

50 / 220

79 / 220

Magazine, for THERMOMARK CARD ..., for accommodating UCT-EMP ...

Technical data

PC
 V0
 -40 ... 125
 Halogen-free

Ordering data

| Type | Order No. | Pcs. / Pkt. |
|---------------|-----------|-------------|
| KMK HP (25X6) | 0830720 | 100 |

Accessories

| | | |
|---------------------------|---------|-----|
| UCT-EMP (25X6) | 1014117 | 10 |
| UCT-EMP (25X6) CUS | 1014121 | 1 |
| US-EMP (25X6)-1 | 0802754 | 10 |
| EMT (25X6)R | 0817264 | 1 |
| WT-HP HF 3,6X140 | 0830982 | 100 |
| WT-HP HF 4,8X200 | 0830983 | 100 |
| WT-HP HF 4,5X290 | 0830984 | 100 |
| THERMOMARK CARD-UCT-MAG26 | 0802988 | 1 |



Lettering field size: 29 x 8 mm,
for cable diameter > 6 mm



Lettering field size: 60 x 15 mm,
for cable diameter > 9 mm



Lettering field size: 40 x 17 mm,
for cable diameter > 9 mm

| Technical data | | | Technical data | | | Technical data | | |
|--|-------------------------------|-------------------|--|-------------------------------|-------------------|--|-------------------------------|-------------------|
| PC V0 -40 ... 125 Halogen-free | | | PC V0 -40 ... 125 Halogen-free | | | PC V0 -40 ... 125 Halogen-free | | |
| Ordering data | | | Ordering data | | | Ordering data | | |
| Type | Order No. | Pcs. / Pkt. | Type | Order No. | Pcs. / Pkt. | Type | Order No. | Pcs. / Pkt. |
| KMK HP (29X8) | 0830721 | 100 | KMK HP (60X15) | 0830722 | 50 | KMK HP (40X17) | 0830723 | 50 |
| Accessories | | | Accessories | | | Accessories | | |
| UCT-EMP (29X8) | 1014118 | 10 | UCT-EMP (60X15) | 1014119 | 10 | UCT-EMP (40X17) | 1014120 | 10 |
| UCT-EMP (29X8) CUS | 1014122 | 1 | UCT-EMP (40X17) CUS | 1014124 | 1 | UCT-EMP (60X15) CUS | 1014123 | 1 |
| US-EMP (29X8) | 0829436 | 10 | US-EMP (60X15) | 0828781 | 10 | US-EMP (40X17) | 0829437 | 10 |
| EMT (29X8)R | 0817277 | 1 | EMT (60X15)R | 0801846 | 10 | EMT (40X17)R | 0817293 | 1 |
| WT-HP HF 3,6X140 WT-HP HF 4,8X200 WT-HP HF 4,5X290 | 0830982 0830983 0830984 | 100 100 100 | WT-HP HF 3,6X140 WT-HP HF 4,8X200 WT-HP HF 4,5X290 | 0830982 0830983 0830984 | 100 100 100 | WT-HP HF 3,6X140 WT-HP HF 4,8X200 WT-HP HF 4,5X290 | 0830982 0830983 0830984 | 100 100 100 |
| THERMOMARK CARD-UCT-MAG26 | 0802988 | 1 | THERMOMARK CARD-UCT-MAG26 | 0802988 | 1 | THERMOMARK CARD-UCT-MAG26 | 0802988 | 1 |

Conductor and cable marking - MARKING system

Plastic cable markers for insert labels, for assembly with cable binders



- KMK UV ... plastic cable markers for marking and bundling conductors and cables outdoors
- The KMK UV... cable markers are ultra-transparent, impact resistant, and have excellent weathering resistance. At the same time, they also possess outstanding chemical resistance
- The KMK... versions have eyelets and are attached with cable binders
- The printed insert label is protected from dirt by the sealing cap
- Labeling service: Phoenix Contact can custom-label all insert labels for plastic cable markers in accordance with your requirements



| Notes: |
|---|
| For matching cable binders, see page 574 onwards in main catalog 5 or the product area on our website at phoenixcontact.net/products. |
| ¹⁾ WT-UV HF...BK cable binders are weatherproof and UV resistant according to ISO 4892 (after QUV-B 600 hours) for up to 10 years. |



Lettering field size: 25 x 6 mm, for cable diameter > 6 mm

| General data | |
|---|------------------|
| Material | PA |
| Inflammability class according to UL 94 | HB |
| Temperature range | -40 ... 100 [°C] |
| Components | Halogen-free |

| Technical data | | |
|----------------|--|--|
| PA | | |
| HB | | |
| -40 ... 100 | | |
| Halogen-free | | |

| Description | Color |
|---|-------------|
| Cable marker carrier for cable binder assembly | transparent |

| Ordering data | | |
|---------------|-----------|-------------|
| Type | Order No. | Pcs. / Pkt. |
| KMK UV (25X6) | 1014106 | 100 |

UniCard, insert strip for KMK... cable marker carriers, can be marked with THERMOMARK CARD... and BLUEMARK CLED

Accessories

Lettering field size: 25 x 6 mm, 15-section
 Lettering field size: 29 x 8 mm, 15-section
 Lettering field size: 60 x 15 mm, 3-section
 Lettering field size: 40 x 17 mm, 3-section

| | | |
|----------------|---------|----|
| UCT-EMP (25X6) | 1014117 | 10 |
|----------------|---------|----|

UniCard, insert strips for KMK... cable marker carriers, **marked according to customer specifications**
 Lettering field size: 25 x 6 mm, 15-section
 Lettering field size: 29 x 8 mm, 15-section
 Lettering field size: 40 x 17 mm, 3-section
 Lettering field size: 60 x 15 mm, 3-section

| | | |
|--------------------|---------|---|
| UCT-EMP (25X6) CUS | 1014121 | 1 |
|--------------------|---------|---|

UniSheet, 0.5 mm thick, inflammability class V0 according to UL 94
 84-section, lettering field size: 25 x 6 mm
 48-section, lettering field size: 29 x 8 mm
 9-section, lettering field size: 60 x 15 mm
 16-section, lettering field size: 40 x 17 mm

| | | |
|-----------------|---------|----|
| US-EMP (25X6)-1 | 0802754 | 10 |
|-----------------|---------|----|

Insert labels for thermal transfer printer, halogen-free

Lettering field size: 25 x 6 mm, 5000 labels per roll
 Lettering field size: 29 x 8 mm, 5400 labels per roll
 Lettering field size: 60 x 15 mm, 2500 labels per roll
 Lettering field size: 40 x 17 mm, 2300 labels per roll

| | | |
|-------------|---------|---|
| EMT (25X6)R | 0817264 | 1 |
|-------------|---------|---|

Cable binder, halogen-free, inflammability class according to UL 94: V2, maximum bundle Ø [mm] / min. tensile strength [N]!

35 / 130
 50 / 220
 79 / 220

| | | |
|---------------------|---------|-----|
| WT-UV HF 3,6X140 BK | 3240832 | 100 |
| WT-UV HF 4,5X200 BK | 3240834 | 100 |
| WT-UV HF 4,5X290 BK | 3240835 | 100 |

Magazine, for THERMOMARK CARD ..., for accommodating UCT-EMP ...

| | | |
|---------------------------|---------|---|
| THERMOMARK CARD-UCT-MAG26 | 0802988 | 1 |
|---------------------------|---------|---|



Lettering field size: 29 x 8 mm,
for cable diameter > 6 mm



Lettering field size: 60 x 15 mm,
for cable diameter > 9 mm



Lettering field size: 40 x 17 mm,
for cable diameter > 9 mm

| Technical data | | |
|----------------|--|--|
| PA | | |
| HB | | |
| -40 ... 100 | | |
| Halogen-free | | |

| Ordering data | | |
|---------------|-----------|-------------|
| Type | Order No. | Pcs. / Pkt. |
| KMK UV (29X8) | 1014107 | 100 |

| Accessories | | |
|---------------------------|-----------|-------------|
| Type | Order No. | Pcs. / Pkt. |
| UCT-EMP (29X8) | 1014118 | 10 |
| UCT-EMP (29X8) CUS | 1014122 | 1 |
| US-EMP (29X8) | 0829436 | 10 |
| EMT (29X8)R | 0817277 | 1 |
| WT-UV HF 3,6X140 BK | 3240832 | 100 |
| WT-UV HF 4,5X200 BK | 3240834 | 100 |
| WT-UV HF 4,5X290 BK | 3240835 | 100 |
| THERMOMARK CARD-UCT-MAG26 | 0802988 | 1 |

| Technical data | | |
|----------------|--|--|
| PA | | |
| HB | | |
| -40 ... 100 | | |
| Halogen-free | | |

| Ordering data | | |
|----------------|-----------|-------------|
| Type | Order No. | Pcs. / Pkt. |
| KMK UV (60X15) | 1014108 | 50 |

| Accessories | | |
|---------------------------|-----------|-------------|
| Type | Order No. | Pcs. / Pkt. |
| UCT-EMP (60X15) | 1014119 | 10 |
| UCT-EMP (60X15) CUS | 1014124 | 1 |
| US-EMP (60X15) | 0828781 | 10 |
| EMT (60X15)R | 0801846 | 10 |
| WT-UV HF 3,6X140 BK | 3240832 | 100 |
| WT-UV HF 4,5X200 BK | 3240834 | 100 |
| WT-UV HF 4,5X290 BK | 3240835 | 100 |
| THERMOMARK CARD-UCT-MAG26 | 0802988 | 1 |

| Technical data | | |
|----------------|--|--|
| PA | | |
| HB | | |
| -40 ... 100 | | |
| Halogen-free | | |

| Ordering data | | |
|----------------|-----------|-------------|
| Type | Order No. | Pcs. / Pkt. |
| KMK UV (40X17) | 1014109 | 50 |

| Accessories | | |
|---------------------------|-----------|-------------|
| Type | Order No. | Pcs. / Pkt. |
| UCT-EMP (40X17) | 1014120 | 10 |
| UCT-EMP (60X15) CUS | 1014123 | 1 |
| US-EMP (40X17) | 0829437 | 10 |
| EMT (40X17)R | 0817293 | 1 |
| WT-UV HF 3,6X140 BK | 3240832 | 100 |
| WT-UV HF 4,5X200 BK | 3240834 | 100 |
| WT-UV HF 4,5X290 BK | 3240835 | 100 |
| THERMOMARK CARD-UCT-MAG26 | 0802988 | 1 |

Device marking - MARKING system

Adhesive UniCard device marking for applications in process engineering

Can be marked using:



UV LED technology



Unlabeled or labeled according to customer specifications

- The UC-EMLP...-EX UniCard labeling range includes self-adhesive device markers with good adhesive properties
- The marking requirements in terms of legibility, adhesion, and wipe resistance in potentially explosive areas (ATEX), according to IEC/EN 60079-0, can also be ensured following storage in typical gas atmospheres. Phoenix Contact developed these sheets especially for process engineering which is where these requirements typically arise. These sheets meet the requirements for wipe resistance according to DIN EN 61010-1 against aggressive media such as acetone, ethanol, and MEK
- Thanks to the special adhesive, the marker meets the demanding requirements of process engineering
- The markers can be marked quickly, easily, and inexpensively with the BLUEMARK CLED and LED
- By using modern UV LED printing technology, a highly resistant and optimum printing quality can be achieved, which is resistant to solvents and suitable for use even under harsh industrial conditions
- Labeling service: Phoenix Contact can custom-label all markers according to your requirements

| General data | |
|---|------|
| Can be marked with | |
| Material | |
| Inflammability class according to UL 94 | |
| Temperature range | [°C] |
| Wipe resistance | |
| Components | |

| Technical data | |
|--------------------------------|--|
| BLUEMARK CLED • BLUEMARK LED | |
| PA | |
| V2 | |
| -40 ... 120 | |
| DIN EN 61010-1 (VDE 0411-1) | |
| Free from silicone and halogen | |

| Description | Color |
|--|-------|
| UniCard, with self-adhesive plastic labels | |
| 6-section, lettering field size: 22 x 22 mm | white |
| 8-section, lettering field size: 27 x 18 mm | white |
| 6-section, lettering field size: 27 x 27 mm | white |
| 4-section, lettering field size: 49 x 15 mm | white |
| 3-section, lettering field size: 60 x 30 mm | white |
| UniCard, with self-adhesive plastic labels, labeled according to customer specifications¹⁾ | |
| 6-section, lettering field size: 22 x 22 mm | white |
| 8-section, lettering field size: 27 x 18 mm | white |
| 6-section, lettering field size: 27 x 27 mm | white |
| 4-section, lettering field size: 49 x 15 mm | white |
| 3-section, lettering field size: 60 x 30 mm | white |

| Ordering data | | | |
|------------------------|-----------|-------------|--|
| Type | Order No. | Pcs. / Pkt. | |
| UC-EMLP (22X22)-EX | 0803224 | 10 | |
| UC-EMLP (27X18)-EX | 0803225 | 10 | |
| UC-EMLP (27X27)-EX | 0803226 | 10 | |
| UC-EMLP (49X15)-EX | 0803227 | 10 | |
| UC-EMLP (60X30)-EX | 0803228 | 10 | |
| UC-EMLP (22X22)-EX CUS | 0803229 | 1 | |
| UC-EMLP (27X18)-EX CUS | 0803230 | 1 | |
| UC-EMLP (27X27)-EX CUS | 0803231 | 1 | |
| UC-EMLP (49X15)-EX CUS | 0803232 | 1 | |
| UC-EMLP (60X30)-EX CUS | 0803233 | 1 | |

Notes:
¹⁾ For an ordering example, see page 358 in main catalog 5.

Adhesive device marking for applications in process engineering



Can be marked using:



Thermal transfer for rolls



Unlabeled or labeled according to customer specifications

- The EML...-EX self-adhesive device markers have been specifically developed for marking various types of equipment in the Ex area
- The marking requirements in terms of legibility, adhesion, and wipe resistance in potentially explosive areas (ATEX), according to IEC/EN 60079-0, can also be ensured following storage in typical gas atmospheres. Phoenix Contact developed these labels especially for process engineering, which is where these requirements typically arise. These labels meet the requirements for wipe resistance according to DIN EN 61010-1 against aggressive media such as acetone, ethanol, and MEK
- They are only suitable in conjunction with the TM- RIBBON110-EX
- Thanks to the special surface and adhesive, the marker meets the demanding requirements of process engineering
- If high-quality ink ribbons are used, the labeling is resistant to solvents, making it suitable for use even under harsh industrial conditions
- A wide range of marker sizes and colors are available for custom designs
- The special packaging protects rolls that have already been started from the dirt found in industrial environments
- **Designation example:**
EML (10x4)R-EX
Lettering field size: 10 x 4 mm
Type of packaging: roll
- Marking service: Phoenix Contact can custom-mark all EML markers according to your requirements

| General data | |
|--------------------|------|
| Can be marked with | |
| Material | |
| Temperature range | [°C] |
| Wipe resistance | |
| Components | |

| Technical data | |
|--|--|
| THERMOMARK ROLL • THERMOMARK ROLL X1 • THERMOMARK X1.1 • THERMOMARK X1.2 • THERMOMARK S1.1 | |
| Polyester | |
| -40 ... 150 | |
| DIN EN 61010-1 (VDE 0411-1) | |
| Free from silicone and halogen | |

| Description | Color |
|--|-------|
| Labels | |
| 10,000 labels per roll | white |
| 2500 labels per roll | white |
| 2500 labels per roll | white |
| 2500 labels per roll | white |
| 1000 labels per roll | white |
| 400 labels per roll | white |
| 300 labels per roll | white |
| 300 labels per roll | white |
| 250 labels per roll | white |
| Labels, labeled according to customer requirements¹⁾ | |
| 8 labels per strip | white |
| 5 labels per strip | white |
| 4 labels per strip | white |
| 3 labels per strip | white |
| 2 labels per strip | white |
| 1 label per strip | white |
| 1 label per strip | white |
| 1 label per strip | white |
| 1 label per strip | white |

| Ordering data | | |
|----------------------|-----------|-------------|
| Type | Order No. | Pcs. / Pkt. |
| EML (10X4)R-EX | 0803251 | 1 |
| EML (15X9)R-EX | 0803253 | 1 |
| EML (20X8)R-EX | 0803254 | 1 |
| EML (30X20)R-EX | 0803255 | 1 |
| EML (40X25)R-EX | 0803256 | 1 |
| EML (70X50)R-EX | 0803257 | 1 |
| EML (100X40)R-EX | 0803258 | 1 |
| EML (100X73)R-EX | 0803259 | 1 |
| EML (100X90)R-EX | 0803260 | 1 |
| EML (10X4)R-EX CUS | 0803261 | 1 |
| EML (15X9)R-EX CUS | 0803262 | 1 |
| EML (20X8)R-EX CUS | 0803263 | 1 |
| EML (30X20)R-EX CUS | 0803264 | 1 |
| EML (40X25)R-EX CUS | 0803266 | 1 |
| EML (70X50)R-EX CUS | 0803267 | 1 |
| EML (100X40)R-EX CUS | 0803268 | 1 |
| EML (100X73)R-EX CUS | 0803269 | 1 |
| EML (100X90)R-EX CUS | 0803270 | 1 |

| |
|--|
| Ink ribbon , length: 300 m, width: 110 mm, color: black |
|--|

| Accessories | | |
|------------------|-----------|-------------|
| Accessories | Order No. | Pcs. / Pkt. |
| TM-RIBBON 110-EX | 0803211 | 1 |

Notes:
¹⁾ For an ordering example, see page 358 in main catalog 5.

Device marking - MARKING system

UniSheet device marking for sticking onto rough or textured surfaces

Can be marked using:

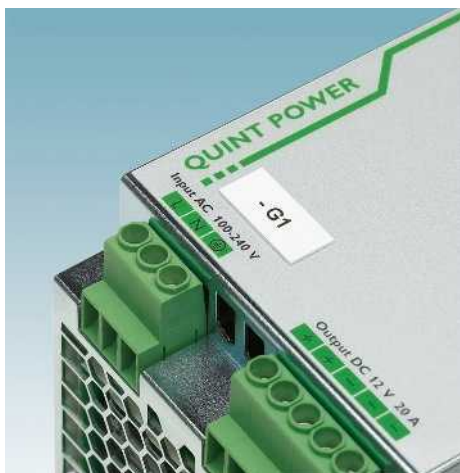

Thermal transfer for sheets and cards



Unlabeled or labeled according to customer specifications

- The US-EMLP-HA ... UniSheet marking range has excellent adhesive properties on rough, textured, and low-energy surfaces, thanks to the special adhesive
- The markers, which are supplied in uniform sheets, can be marked quickly, easily, and cost-effectively using THERMOMARK CARD and THERMOMARK CARD PLUS
- The perforated markers are easy to separate and can be easily fitted
- The sheets provide space for including function texts
- Marking service: Phoenix Contact can custom-mark all US-EMLP-HA ... markers according to your requirements

General data

| | |
|---|------|
| Can be marked with | |
| Material | |
| Inflammability class according to UL 94 | |
| Temperature range | [°C] |
| Wipe resistance | |
| Components | |

Technical data

| |
|--|
| THERMOMARK CARD PLUS • THERMOMARK CARD |
| PVC |
| V0 |
| -30 ... 80 |
| DIN EN 61010-1 (VDE 0411-1) |
| Silicone-free |

| Description | Color |
|---|--------|
| UniSheet, with self-adhesive plastic labels, 0.5 mm thick | |
| 108-section, lettering field size: 17 x 7 mm | white |
| 70-section, lettering field size: 20 x 9 mm | white |
| 4-section, lettering field size: 60 x 30 mm | white |
| 4-section, lettering field size: 60 x 30 mm | silver |
| 2-section, lettering field size: 85.6 x 54 mm | white |
| 2-section, lettering field size: 85.6 x 54 mm | silver |
| UniSheet, with self-adhesive plastic labels, 0.5 mm thick, labeled acc. to customer specifications | |
| 108-section, lettering field size: 17 x 7 mm | white |
| 70-section, lettering field size: 20 x 9 mm | white |
| 4-section, lettering field size: 60 x 30 mm | white |
| 4-section, lettering field size: 60 x 30 mm | silver |
| 2-section, lettering field size: 85.6 x 54 mm | white |
| 2-section, lettering field size: 85.6 x 54 mm | silver |

Ordering data

| Type | Order No. | Pcs. / Pkt. |
|-----------------------------|-----------|-------------|
| US-EMLP-HA (17X7) | 0830988 | 10 |
| US-EMLP-HA (20X9) | 0830989 | 10 |
| US-EMLP-HA (60X30) | 0830990 | 10 |
| US-EMLP-HA (60X30) SR | 0830991 | 10 |
| US-EMLP-HA (85,6X54) | 0830992 | 10 |
| US-EMLP-HA (85,6X54) SR | 0830993 | 10 |
| US-EMLP-HA (17X7) CUS | 0830994 | 1 |
| US-EMLP-HA (20X9) CUS | 0830995 | 1 |
| US-EMLP-HA (60X30) CUS | 0830996 | 1 |
| US-EMLP-HA (60X30) SR CUS | 0830997 | 1 |
| US-EMLP-HA (85,6X54) CUS | 0830998 | 1 |
| US-EMLP-HA (85,6X54) SR CUS | 0830999 | 1 |

| |
|--|
| Magazine, for THERMOMARK CARD... , for accommodating all US materials |
|--|

Accessories

| | | |
|-------------------------|---------|---|
| THERMOMARK CARD-US-MAG1 | 5146451 | 1 |
|-------------------------|---------|---|



RFMARK high-frequency handheld

RFMARK HF is a powerful handheld device for contact-free reading and writing of HF transponders. The RFMARK HF can identify and locate HF transponders. Data can be received, transmitted, and scanned on a contact-free basis and without visual contact.



RFMARK ultra-high frequency handheld

The RFMARK UHF is a powerful handheld device which is equipped with a crossed dipole antenna. This allows UHF transponders to be written and read regardless of their position. Bulk detection of 150 transponders per second is also possible.

Dimensions

| General data | [mm] |
|----------------------|-------|
| Degree of protection | |
| Temperature range | [°C] |
| Weight | [kg] |
| Frequency | [MHz] |
| Read/write format | [m] |
| Memory | |
| Display | |

Description

Handheld, high-frequency range

Range up to 0.1 m, depending on the environment

Handheld, ultra-high frequency range

Range up to 2.0 m, depending on the environment



Advantages and accessories

Advantages of the RFMARK readers:

- Easy operation via touch screen
- Low power consumption and long battery life
- 1D laser scanner and 2D imager

Matching accessories

You can make optimum use of the RFMARK readers and ensure they are as user-friendly as possible with our reader accessories.



Radio-frequency identification, RFID

Used for contact-free identification, data exchange, and localization of transponders/tags without visual contact. With the aid of an RFID handheld device, which acts as a transmitter and receiver, data is transmitted to and received from a transponder/tag by electromagnetic waves (UHF) or a magnetic field (HF).

Charging and data exchange station, with replacement battery, connection for USB 2.0 and Ethernet, charger

for RFMARK HF, with power supply unit and power cable (EU/UK)

for RFMARK UHF, with power supply unit and power cable (EU/UK/US/CN)

Replacement battery

for RFMARK HF, Li-ion 7.4 V, 2.6 Ah

for RFMARK UHF, Li-ion 3.7 V, 2.26 Ah

Protective bag, with strap, protection against splash water, touch screen operation not possible

for RFMARK HF

for RFMARK UHF

Belt pouch, touch screen can be operated

for RFMARK HF

for RFMARK UHF

Read and write USB stick,

Crossed dipole antenna, range: 1 m



Handheld, high-frequency (HF)



Handheld, ultra-high frequency (UHF)

| Technical data | | |
|-------------------------|--------|--------|
| Width | Length | Height |
| 90 | 250 | 45 |
| IP54 | | |
| -20 ... 55 | | |
| 0.55 | | |
| 13.56 | | |
| Max. 0.1 | | |
| 256 MB DDR RAM | | |
| 3.5" color touch screen | | |

| Technical data | | |
|-------------------------|--------|--------|
| Width | Length | Height |
| 60 | 147 | 39 |
| IP54 | | |
| -20 ... 55 | | |
| 0.235 | | |
| 868 | | |
| Max. 2 | | |
| 256 MB DDR RAM | | |
| 2.2" color touch screen | | |

| Ordering data | | |
|---------------|-----------|-------------|
| Type | Order No. | Pcs. / Pkt. |
| RFMARK HF | 5148010 | 1 |

| Ordering data | | |
|---------------|-----------|-------------|
| Type | Order No. | Pcs. / Pkt. |
| RFMARK UHF | 5148011 | 1 |

| Accessories | | |
|------------------------------|-----------|-------------|
| Type | Order No. | Pcs. / Pkt. |
| RFMARK HF POWER LINK STATION | 5148013 | 1 |
| RFMARK HF/ACCU | 5148015 | 1 |
| RFMARK HF PROTECTION CASE | 5148017 | 1 |
| RFMARK HF/BELTPOUCH | 5148018 | 1 |

| Accessories | | |
|-------------------------------|-----------|-------------|
| Type | Order No. | Pcs. / Pkt. |
| RFMARK UHF POWER LINK STATION | 5148014 | 1 |
| RFMARK UHF/ACCU | 5148016 | 1 |
| RFMARK UHF PROTECTION CASE | 5148020 | 1 |
| RFMARK UHF/BELTPOUCH | 5148021 | 1 |
| RFMARK UHF FD | 5148012 | 1 |

System marking - MARKING system

Adhesive system marking with RFID transponder

Can be marked using:



UV LED technology



Unlabeled

Markers

- The UCT-PMLP-RFID ... UniCard labeling range includes self-adhesive markers for system marking, with good adhesive properties
- The markers are integrated in a uniform matrix and can be printed quickly and easily with the BLUEMARK CLED
- The format automatically ensures printing with a high level of positional accuracy
- The wide temperature range means that the labels can be used both indoors and outdoors

Inlays

- The HF transponder inlays comply with ISO 15693 and ISO 18000-3 mode 1
- The UHF transponder inlays comply with EPC Class 1 Gen 2 and ISO 18000-6C

| General data | |
|--------------------|--------------------------------|
| Can be marked with | BLUEMARK CLED |
| Material | PVC/PC |
| Temperature range | -25 ... 80 [°C] |
| Wipe resistance | DIN EN 61010-1 (VDE 0411-1) |
| Components | Free from silicone and cadmium |

Technical data

| | | |
|--------------------------------|--|--|
| BLUEMARK CLED | | |
| PVC/PC | | |
| -25 ... 80 | | |
| DIN EN 61010-1 (VDE 0411-1) | | |
| Free from silicone and cadmium | | |

| Description | Color |
|---|-------|
| UniCard, self-adhesive plastic label, with integrated HF transponder 1-section, lettering field size: 90 x 38 mm, reading performance: max. 0.1 m, depending on the environment | white |
| UniCard, self-adhesive plastic label, with integrated UHF transponder 1-section, lettering field size: 90 x 38 mm, reading performance: max. 2.0 m, depending on the environment | white |

Ordering data

| Type | Order No. | Pcs. / Pkt. |
|--------------------------|-----------|-------------|
| UCT-PMLP-RFID/HF (90X38) | 0830956 | 10 |





Unlabeled

Technical data

BLUEMARK CLED
 PVC/PC
 -25 ... 80
 DIN EN 61010-1 (VDE 0411-1)
 Free from silicone and cadmium

Ordering data

| Type | Order No. | Pcs. / Pkt. |
|---------------------------|-----------|-------------|
| UCT-PMLP-RFID/UHF (90X38) | 0830957 | 10 |



Unlabeled



For securing with rivets on CARRIER-PMP ...



For mounting with screws, screw clamps, or cable binders

Technical data

BLUEMARK CLED
PVC/PC
V2
-25 ... 80
DIN EN 61010-1 (VDE 0411-1)
Free from silicone and cadmium

Technical data

-
PVC
V0
-30 ... 80
DIN EN 61010-1 (VDE 0411-1)
Silicone-free

Technical data

-
PA
V2
-40 ... 105
-
Free from silicone and halogen

Ordering data

| Type | Order No. | Pcs. / Pkt. |
|-----------------------------|-----------|-------------|
| UCT-PMP-RFID/UHF (90X38) | 0830955 | 10 |
| UCT-PMP-RFID/UHF (90X38) OG | 0803048 | 10 |

Ordering data

| Type | Order No. | Pcs. / Pkt. |
|----------------|-----------|-------------|
| PMST (9X38) | 0830960 | 100 |
| PMST (9X38) YE | 0830964 | 100 |
| PMST (9X38) OG | 0830966 | 100 |
| PMST (9X38) RD | 0830962 | 100 |
| PMST (9X38) VT | 0830967 | 100 |
| PMST (9X38) GN | 0830961 | 100 |
| PMST (9X38) GY | 0830963 | 100 |
| PMST (9X38) BN | 0830968 | 100 |
| PMST (9X38) BU | 0830969 | 100 |
| PMST (9X38) BK | 0830965 | 100 |

Ordering data

| Type | Order No. | Pcs. / Pkt. |
|----------------------|-----------|-------------|
| CARRIER-PMP (108X38) | 0830958 | 10 |

Accessories

| Type | Order No. | Pcs. / Pkt. |
|------|-----------|-------------|
|------|-----------|-------------|

Accessories

| Type | Order No. | Pcs. / Pkt. |
|------|-----------|-------------|
|------|-----------|-------------|

Accessories

| Type | Order No. | Pcs. / Pkt. |
|----------------|-----------|-------------|
| SCRT 9X16-27 | 0830970 | 50 |
| SCRT 9X25-40 | 0830971 | 50 |
| SCRT 9X40-60 | 0830972 | 25 |
| SCRT 9X60-80 | 0830973 | 25 |
| SCRT 9X80-100 | 0830974 | 25 |
| SCRT 9X100-120 | 0830975 | 25 |
| SCRT 9X140-160 | 0830976 | 25 |
| SCRT 9X160-180 | 0830977 | 25 |
| SCRT 9X180-200 | 0830978 | 25 |
| RVT-PA 3,5 BK | 0830959 | 100 |

System marking - MARKING system

System marking for sticking on or inserting into marker carriers



- The UCT-PMLP ... UniCard marking range includes self-adhesive markers for system marking, with good adhesive properties
- The UniCard UCT-PMP ... marking range includes markers for system marking, specially designed to fit into existing CARRIER-PMP (108x38) marker carriers
- The format automatically ensures printing with a high level of positional accuracy
- The wide temperature range means that the labels can be used both indoors and outdoors
- Labeling service: Phoenix Contact can custom-label all UniCard markers in accordance with your requirements
- The CARRIER-PMP ... marker carriers can be equipped with colored PMST markers according to DIN 2403

| Notes: |
|---|
| 1) For an ordering example, see page 358 in main catalog 5. |
| 2) RVT-PA...BK rivet for fixing PMST ... marker strips to the CARRIER-PMP ... |

Can be marked using:



UV LED technology



For self-adhesion

| Dimensions | |
|---|------|
| General data | |
| Can be marked with | |
| Material | |
| Inflammability class according to UL 94 | |
| Temperature range | [°C] |
| Wipe resistance | |
| Components | |

| Technical data | | |
|----------------|--------|--------|
| Width | Length | Height |

| | | |
|--------------------------------|--|--|
| BLUEMARK CLED | | |
| PC | | |
| V0 | | |
| -40 ... 120 | | |
| DIN EN 61010-1 (VDE 0411-1) | | |
| Free from silicone and halogen | | |

| Description | Color |
|---|--------|
| UniCard , plastic label, for gluing | |
| 1-section, lettering field size: 90 x 38 mm | white |
| UniCard , plastic label, for gluing, marked according to customer specifications ¹⁾ | |
| 1-section, lettering field size: 90 x 38 mm | white |
| UniCard , plastic label | |
| 1-section, lettering field size: 90 x 38 mm | white |
| 1-section, lettering field size: 90 x 38 mm | blue |
| 1-section, lettering field size: 90 x 38 mm | violet |
| 1-section, lettering field size: 90 x 38 mm | yellow |
| UniCard , plastic label, marked according to customer specifications ¹⁾ | |
| 1-section, lettering field size: 90 x 38 mm | white |
| 1-section, lettering field size: 90 x 38 mm | blue |
| 1-section, lettering field size: 90 x 38 mm | violet |
| 1-section, lettering field size: 90 x 38 mm | yellow |

Ordering data

| Type | Order No. | Pcs. / Pkt. |
|-----------------------------|-----------|-------------|
| UCT-PMLP (90X38) | 0803041 | 10 |
| UCT-PMLP (90X38) CUS | 0803042 | 1 |

| Marking label for conveyed fluids, for equipping CARRIER-PMP ... according to DIN 2403 |
|--|
| white |
| yellow |
| orange |
| red |
| violet |
| green |
| gray |
| brown |
| blue |
| black |

| Marker carriers, for UCT-PMP ... labels that can be inserted | |
|--|-------|
| Carrier size: 108 x 38 mm | black |



Mounting strip, can be screwed, for CARRIER-PMP ...

Plastic body-bound rivet, 3.5 mm diameter²⁾

Accessories

PRINTED
FOR YOU



For inserting into a marker carrier



For securing with rivets on CARRIER-PMP ...



For mounting with screws, screw clamps,
or cable binders

| Technical data | | |
|----------------|--------|--------|
| Width | Length | Height |

BLUEMARK CLED
PC
V0
-40 ... 120
DIN EN 61010-1 (VDE 0411-1)
Free from silicone and halogen

| Technical data | | |
|----------------|--------|--------|
| Width | Length | Height |

-
PVC
V0
-30 ... 80
DIN EN 61010-1 (VDE 0411-1)
Silicone-free

| Technical data | | |
|----------------|--------|--------|
| Width | Length | Height |

-
PA
V2
-40 ... 105
-
Free from silicone and halogen

| Ordering data | | |
|---------------|--|--|
|---------------|--|--|

| Type | Order No. | Pcs. / Pkt. |
|------------------------|-----------|-------------|
| UCT-PMP (90X38) | 0803039 | 10 |
| UCT-PMP (90X38) BU | 0803047 | 10 |
| UCT-PMP (90X38) VT | 0803132 | 10 |
| UCT-PMP (90X38) YE | 0803133 | 10 |
| UCT-PMP (90X38) CUS | 0803040 | 1 |
| UCT-PMP (90X38) BU CUS | 8190566 | 1 |
| UCT-PMP (90X38) VT CUS | 8190707 | 1 |
| UCT-PMP (90X38) YE CUS | 8190708 | 1 |

| Ordering data | | |
|---------------|--|--|
|---------------|--|--|

| Type | Order No. | Pcs. / Pkt. |
|----------------|-----------|-------------|
| PMST (9X38) | 0830960 | 100 |
| PMST (9X38) YE | 0830964 | 100 |
| PMST (9X38) OG | 0830966 | 100 |
| PMST (9X38) RD | 0830962 | 100 |
| PMST (9X38) VT | 0830967 | 100 |
| PMST (9X38) GN | 0830961 | 100 |
| PMST (9X38) GY | 0830963 | 100 |
| PMST (9X38) BN | 0830968 | 100 |
| PMST (9X38) BU | 0830969 | 100 |
| PMST (9X38) BK | 0830965 | 100 |

| Ordering data | | |
|---------------|--|--|
|---------------|--|--|

| Type | Order No. | Pcs. / Pkt. |
|----------------------|-----------|-------------|
| CARRIER-PMP (108X38) | 0830958 | 10 |

| Accessories | | |
|-------------|--|--|
|-------------|--|--|

| | | |
|--|--|--|
| | | |
|--|--|--|

| Accessories | | |
|-------------|--|--|
|-------------|--|--|

| | | |
|--|--|--|
| | | |
|--|--|--|

| Accessories | | |
|-------------|--|--|
|-------------|--|--|

| | | |
|----------------|---------|-----|
| SCRT 9X16-27 | 0830970 | 50 |
| SCRT 9X25-40 | 0830971 | 50 |
| SCRT 9X40-60 | 0830972 | 25 |
| SCRT 9X60-80 | 0830973 | 25 |
| SCRT 9X80-100 | 0830974 | 25 |
| SCRT 9X100-120 | 0830975 | 25 |
| SCRT 9X140-160 | 0830976 | 25 |
| SCRT 9X160-180 | 0830977 | 25 |
| SCRT 9X180-200 | 0830978 | 25 |
| RVT-PA 3,5 BK | 0830959 | 100 |



Material editor

The material editor allows you to create the required markings directly in the application environment via tablet PC or smartphone.



Product scanner

The product scanner allows you to quickly and easily call up technical data for the marking material or directly mark it via the material editor.

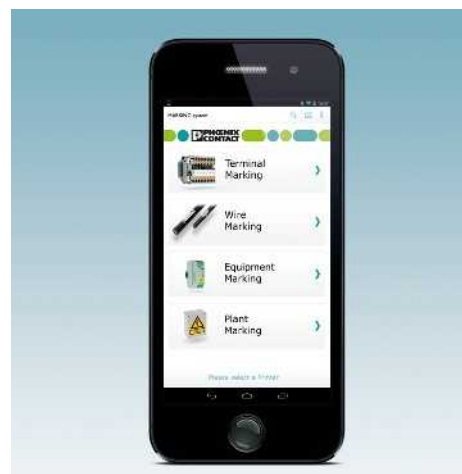

Search assistant

With the search assistant, you can carry out a structured, targeted search for suitable marking materials, even without knowledge of this field.

MARKING system app



You can retrofit your THERMOMARK LINE printer with MINI FD BLUETOOTH. MINI FD BLUETOOTH enables reliable, wireless data exchange between THERMOMARK LINE printers and mobile, Bluetooth-capable devices, such as smartphones and tablet PCs. This means that print orders can be conveniently sent to the printer using the MARKING system app.

Notes:
For additional information on the THERMOMARK LINE printers, please refer to the product area on our website at phoenixcontact.net/products or main catalog 5.



| General data | |
|--------------------|---------------|
| Application | USB/Bluetooth |
| Transmission speed | 3 [Mbps] |

| Description |
|------------------------------|
| Bluetooth USB adapter |

Thermal transfer printer for cards, incl. European power cable, US power cable, USB cable, DVD with CLIP PROJECT ADVANCED, CD with multilingual user manual/driver/firmware, DIN A5 printed English/German user manual, magazine for UCT-TM materials, magazine for US materials, one unit pack UCT-TM 6, one unit pack US-EMLP (85.6 x 54), one ink ribbon (50-meter sample roll)

Thermal transfer printer for material off the roll, including European power cable, US power cable, USB cable, DVD with CLIP PROJECT ADVANCED, CD with multilingual user manual/driver/firmware, A5 printed English/German user manual, one roll of EML (20x8) labels containing 1000 labels, one ink ribbon (50 meters)

Thermal transfer printer, incl. connecting cable, Windows® printer driver and operating instructions, software

| Technical data | | |
|----------------|--|--|
| USB/Bluetooth | | |
| 3 | | |

| Ordering data | | |
|-------------------|-----------|-------------|
| Type | Order No. | Pcs. / Pkt. |
| MINI FD BLUETOOTH | 0830986 | 1 |

| Accessories | | |
|----------------------|---------|---|
| THERMOMARK CARD | 5146464 | 1 |
| THERMOMARK CARD PLUS | 5146481 | 1 |
| THERMOMARK ROLL | 5146477 | 1 |
| THERMOMARK ROLL X1 | 5146723 | 1 |
| THERMOMARK X1.2 | 5146231 | 1 |

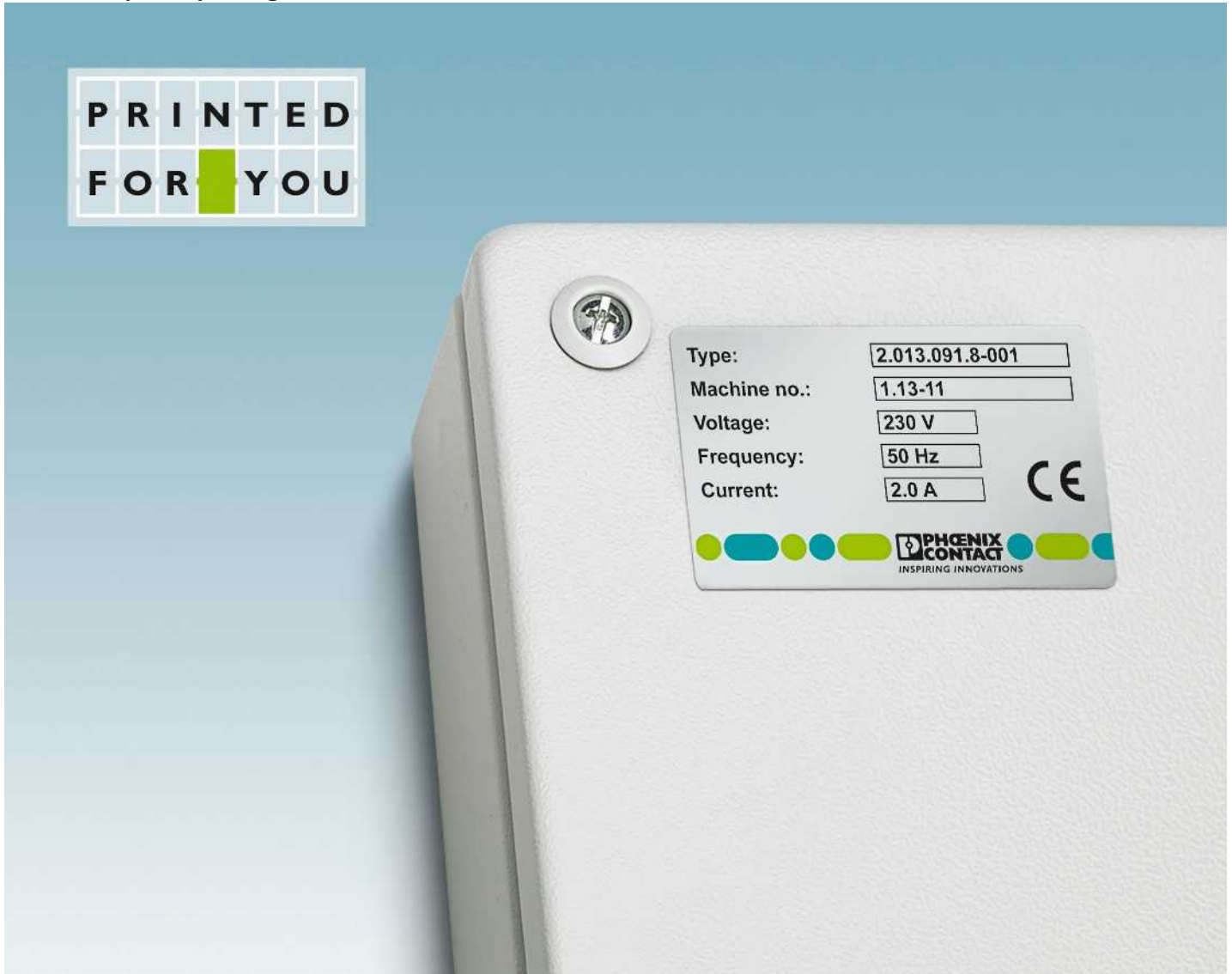

Easy ordering process via CLIP PROJECT and e-mail

You can create customer-specific marking quickly and easily via CLIP PROJECT and order via e-mail.



New: color-printed marking solutions

You can use marking materials in UniCard and UniSheet format as well as metal labels for color printing.



We mark marking materials according to your requirements

All materials which can be marked according to customer requirements are indicated with this symbol.

CLIP PROJECT
advanced and professional

CLIP PROJECT advanced

The CLIP PROJECT advanced program enables the quick planning and configuration of terminal strips for the control cabinet and field as well as custom-marking of terminal blocks, cables, and lines, plus devices and systems:

- The automatic correction function performs a logical test of the terminal strips and automatically adds the necessary accessories such as covers and end brackets
- The terminal strip configurator enables the distributed arrangement of individual terminal strips on different DIN rails
- 3D preview and complete documentation of the assembled DIN rails, such as order and mounting lists
- Numerous sorting and filter functions for efficient management of your print jobs
- One software for all output devices: CLIP PROJECT controls all marking technologies from Phoenix Contact, from the BLUEMARK CLED high-speed printer, the THERMOMARK LINE thermal transfer printer, and the plotter to the TOPMARK LASER desktop laser marker
- Continual extension of the output devices and marking materials via updates
- Automatic Internet update
- Intuitive Windows® user interface
- CLIP PROJECT supports all marking materials from Phoenix Contact, from V4A stainless steel and aluminum to plastics such as polyamide or polycarbonate or foils made of PVC or polyester. These are stored with preset parameters

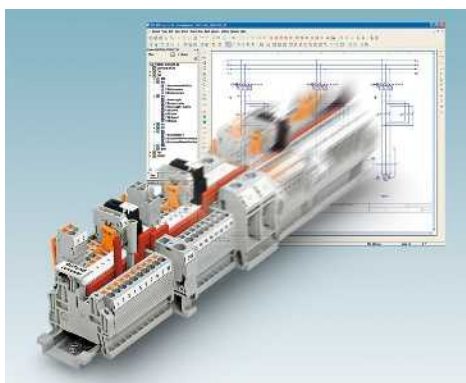

| |
|--|
| General data |
| Software interface |
| System requirements |
| Operating systems |
| Description |
| CLIP PROJECT advanced, planning and marking software, German/English/French/Dutch/Italian/Spanish/Russian/Polish/Hungarian/Czech/Turkish/Portuguese/Chinese and Japanese |
| CLIP PROJECT professional, planning and marking software, with template designer, German/English/French/Dutch/Italian/Spanish/Russian/Polish/Hungarian/Czech/Turkish/Portuguese/Chinese and Japanese |

| Technical data | | |
|---|-----------|-------------|
| EPLAN 5.7 EPLAN Electric P8 AUCOTEC ELCAD AUCOTEC Engineering Base AUCOTEC RUPLAN ZUKEN E³ Bentley Promis-e WSCAD IGE XAO PC-Schematic AUTOMATION SDProget SPAC | | |
| MS Windows XP SP3, MS Windows Vista, MS Windows 7 (32/64-bit), MS Windows 8 (32/64-bit) | | |
| Ordering data | | |
| Type | Order No. | Pcs. / Pkt. |
| CLIP-PROJECT ADVANCED | 5146040 | 1 |
| CLIP-PROJECT PROFESSIONAL | 5146053 | 1 |

CLIP PROJECT professional

- The professional version also includes an efficient template designer, which can be used to design signs of your choice and to adapt existing material descriptions
- Graphics, various barcode types, and geometric elements such as squares, circles, and lines can be accessed for design work
- Data can also be imported into the templates from various data sources

CRIMPHANDY - portable hand-held machine. Stripping and crimping in just one step.



Simply insert the conductor, ...



... stripping and crimping is carried out automatically, ...

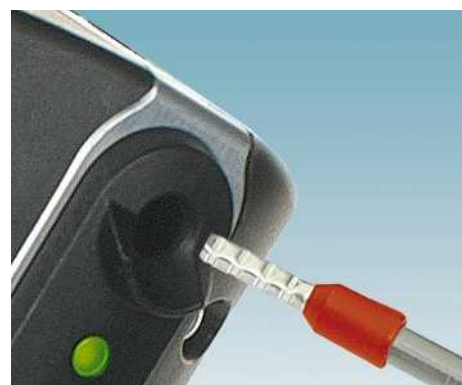

... and you're done.



Easy operation thanks to the automatic stripping and crimping function. One tool for both work steps, resulting in time savings of approx. 75%. The device signals the operating states clearly by means of colored LEDs.

Automatic cross-section monitoring prevents faulty crimping as a result of incorrect cross sections. The device displays a corresponding message.

The efficiency is particularly evident when used in combination with the push-in connection terminal block PT: conductors are processed and contacted in no time at all.



Integrated magazine for ferrules in strip form. The automatic feed enables conductors to be crimped one after another.

Easy to remove collecting chamber for discarded insulation. This guarantees a clean working environment. At around just 430 grams, the device can also easily be used inside the control cabinet.

Integrated lithium-ion polymer rechargeable battery for up to 2000 crimps. The fast charger provided charges the battery, which is easy to replace, in just 60 minutes.

Tools - TOOL fox

CRIMPHANDY, portable hand-held machine, for a 1.0 to 1.5 mm² conductor cross section



The product innovation for switchgear manufacturing – the CRIMPHANDY. With this portable hand-held machine, you can strip and crimp your conductors in under two seconds – 75% less time than before.

- The matching reel ferrules are suitable for use on all modular terminal blocks, particularly those from the CLIPLINE complete system:
- UT screw connection terminal blocks
- ST spring-cage connection terminal blocks
- PT push-in connection terminal blocks
- COMBI plug-in connection solutions

Notes:

An application video can be found in the download area for the relevant product on our website at phoenixcontact.net/products.



1.0 mm² conductor cross section

| Dimensions | |
|---------------|--------------------|
| | [mm] |
| General data | |
| Weight | [kg] |
| Conductor | [mm ²] |
| Working cycle | [s] |
| Compression | |

| Technical data | | |
|----------------|--------|--------|
| Width | Length | Height |
| 43 | 205 | 70 |
| 0.43 | - 1 | < 2 |
| Square crimp | | |

| Description | |
|---|--|
| Portable hand-held machine, battery-powered , for ferrules, 1.0 mm ² , incl. battery and charger, 100 - 240 V, in a robust case | |
| for standard PVC conductors | |
| Portable hand-held machine, battery-powered , for ferrules, 1.5 mm ² , incl. battery and charger, 100 - 240 V, in a robust case | |
| for standard PVC conductors | |

| Ordering data | | |
|-------------------|-----------|-------------|
| Type | Order No. | Pcs. / Pkt. |
| CF CRIMPHANDY 1,0 | 1212465 | 1 |

| |
|--|
| Reel ferrules , 1.0 mm ² , 8 mm, with plastic sleeve, according to DIN 46228-4, 50 pieces per strip, 20 strips per unit pack |
| Red, according to DIN 46228-4 |
| Yellow, special color |
| Reel ferrules , 1.5 mm ² , 8 mm, with plastic sleeve, according to DIN 46228-4, 50 pieces per strip, 20 strips per unit pack |
| Black, according to DIN 46228-4 |
| Red, special color |
| Replacement battery , for CF CRIMPHANDY..., Li-ion 7.4 V, 0.76 Ah |
| Replacement charger , for CF CRIMPHANDY..., 100 - 240 V AC |

| Accessories | | |
|-----------------------|-----------|-------------|
| Type | Order No. | Pcs. / Pkt. |
| AI 1,0-8 RD-S | 1212523 | 1000 |
| AI 1,0-8 YE-S | 1212782 | 1000 |
| CF CRIMPHANDY/ACCU | 1212518 | 1 |
| CF CRIMPHANDY/CHARGER | 1212519 | 1 |





1.5 mm² conductor cross section

Technical data

| Width | Length | Height |
|--------------|--------|--------|
| 43 | 205 | 70 |
| 0.43 | | |
| - 1.5 | | |
| < 2 | | |
| Square crimp | | |

Ordering data

| Type | Order No. | Pcs. / Pkt. |
|-------------------|-----------|-------------|
| CF CRIMPHANDY 1,5 | 1212466 | 1 |

Accessories

| | | |
|-----------------------|---------|------|
| AI 1,5-8 BK-S | 1212524 | 1000 |
| AI 1,5-8 RD-S | 1212781 | 1000 |
| CF CRIMPHANDY/ACCU | 1212518 | 1 |
| CF CRIMPHANDY/CHARGER | 1212519 | 1 |

Tools - TOOL fox

CUS tool sets, equipped with tools according to customer requirements



You can put together your own CUS tool set according to your individual requirements

- Six different bags are available, designed for typical applications
- Easily select your tools at phoenixcontact.net/products

Notes:

The CUS tool sets can be put together according to your requirements in the product area on our website at phoenixcontact.net/products.

TOOLS FOR YOU



Tool case, lockable, with straps

Description

Toolbox, lockable, with adjustable strap, equipped with: cable cutter, diagonal cutter, micro cutter, stripping and sheath stripping tools, crimping tool set, combination, needle-nose, and water pump pliers, VDE bladed and Phillips screwdrivers, control cabinet key, voltage tester, ferrule box, blades, tape measure, continuity tester, marking tool, ring, open-end, and adjustable wrench set, T-handle hexagonal wrench, safety glasses, hammer, 41-piece ratchet socket wrench set, 1/4"

Toolbox, lockable, with adjustable strap, equipped with tools according to customer requirements

Ordering data

| Type | Order No. | Pcs. / Pkt. |
|---------------|-----------|-------------|
| TOOL-CASE | 1212629 | 1 |
| TOOL-CASE CUS | 1200072 | 1 |

CUS tool sets, equipped with tools according to customer requirements

Notes:

The CUS tool sets can be put together according to your requirements in the product area on our website at phoenixcontact.net/products.

TOOLS FOR YOU



Tool bag, with document and laptop compartments

TOOLS FOR YOU



Tool bag, with strap

Ordering data

| Type | Order No. | Pcs. / Pkt. |
|--------------|-----------|-------------|
| TOOL-BAG CUS | 1200081 | 1 |

Ordering data

| Type | Order No. | Pcs. / Pkt. |
|------------------|-----------|-------------|
| TOOL-CARRIER CUS | 1200082 | 1 |

Description

Tool bag, with adjustable straps, with document and laptop compartments, equipped with tools according to customer requirements

Tool bag, with strap, very comfortable to carry thanks to ergonomic shape, equipped with tools according to customer requirements

CUS tool sets, equipped with tools according to customer requirements



Notes:
The CUS tool sets can be put together according to your requirements in the product area on our website at phoenixcontact.net/products.

TOOLS FOR YOU



Tool belt pouch

Description
Tool belt pouch, with two robust internal pockets, equipped with tools according to customer requirements

| Ordering data | | |
|--------------------|-----------|-------------|
| Type | Order No. | Pcs. / Pkt. |
| TOOL-BELTPOUCH CUS | 1200084 | 1 |

- Individual tool sets, with cutting, stripping, crimping, installation, and testing tools from the TOOL fox tool range
- Rugged and heavy-duty tool bags
- Select from six types of bag and equip these with the required tools at phoenixcontact.net/products

CUS tool sets, equipped with tools according to customer requirements

Notes:
The CUS tool sets can be put together according to your requirements in the product area on our website at phoenixcontact.net/products.

TOOLS FOR YOU



Tool case

TOOLS FOR YOU



Wrap-up tool bag

| Ordering data | | |
|---------------|-----------|-------------|
| Type | Order No. | Pcs. / Pkt. |
| TOOL-KIT CUS | 1200085 | 1 |

Description
Tool case, with elastic straps to hold the tools in place, equipped with tools according to customer requirements

Wrap-up tool bag, with slide-in compartments and robust elastic straps to hold the tools in place, equipped with tools according to customer requirements

| Ordering data | | |
|---------------|-----------|-------------|
| Type | Order No. | Pcs. / Pkt. |
| TOOL-WRAP CUS | 1200083 | 1 |

Tools - TOOL fox

CRIMPFOX pliers, laser marked according to customer specifications



- Customize your crimping tool!
- You can now use robust laser engraving to mark CRIMPFOX pliers
- Individual laser marking prevents your tools from being mixed up

Notes:

Matching accessories can be found in main catalog 5 or the product area on our website at phoenixcontact.net/products.

¹⁾ Tools with customer-specific laser marking can be ordered quickly and easily in the product area on our website at phoenixcontact.net/products.

- The advantages of our CRIMPFOX tools:
- Consistently high crimping quality
 - Unlockable pressure lock
 - Marked die stations for precise processing of the relevant cross sections
 - Easy work thanks to improved force transfer
 - Ergonomically designed, non-slip handles
 - CRIMPFOX 6S-F CUS: the self-adjusting die automatically adapts to the connector size

Description

Crimping pliers, for ferrules, according to DIN 46228-1 and -4, five marked die stations, **laser marked according to customer specifications¹⁾**

Lateral insertion, 0.25 - 6.0 mm², unlockable pressure lock, trapezoidal crimp

Front insertion, 0.5 - 6 mm², square crimp

Crimping pliers, unlockable pressure lock, lateral insertion, oval crimp, **laser marked according to customer specifications¹⁾**

For insulated cable lugs (light green, red), 0.14 - 1 mm², three marked die stations

For insulated cable lugs (red, blue), 0.75 - 2.5 mm², two marked die stations

Crimping pliers, for uninsulated cable lugs, three marked die stations, 0.34 - 2.5 mm², unlockable pressure lock, lateral insertion, indent crimp, **laser marked according to customer specifications¹⁾**

Crimping pliers, for uninsulated slip-on sleeves 2.8/4.8/6.3 mm, three marked die stations, B-crimp, 0.1 - 1.5 mm², unlockable pressure lock, lateral insertion, **laser marked according to customer specifications¹⁾**

Crimping pliers, for ferrules according to DIN 46228-1 and -4, self-adjusting die, trapezoidal crimp, 0.5 - 6 mm², unlockable pressure lock, **laser marked according to customer specifications¹⁾**

Front insertion
Lateral insertion

Crimping pliers, three marked die stations, 0.75 - 6 mm², oval crimp, unlockable pressure lock, lateral insertion, **laser marked according to customer specifications¹⁾**

For insulated cable lugs, symmetrical (red, blue, yellow)
For insulated cable lugs, asymmetrical (red, blue, yellow)

Crimping pliers, for ferrules according to DIN 46228-1 and -4, WM crimp, unlockable pressure lock, lateral insertion, **laser marked according to customer specifications¹⁾**

Three marked die stations, 10 - 25 mm²

Two marked die stations, 35 - 50 mm²

TOOLS FOR YOU



TOOLS FOR YOU



TOOLS FOR YOU



| Ordering data | | | Ordering data | | | Ordering data | | |
|----------------------|-----------|-------------|-------------------|-----------|-------------|----------------------|-----------|-------------|
| Type | Order No. | Pcs. / Pkt. | Type | Order No. | Pcs. / Pkt. | Type | Order No. | Pcs. / Pkt. |
| CRIMPFOX 6 CUS | 1212767 | 1 | | | | | | |
| CRIMPFOX 6S-F CUS | 1212769 | 1 | | | | | | |
| CRIMPFOX-RC1 1 CUS | 1212772 | 1 | | | | | | |
| CRIMPFOX-RC1 2,5 CUS | 1212773 | 1 | | | | | | |
| CRIMPFOX-RC 2,5 CUS | 1212777 | 1 | | | | | | |
| CRIMPFOX-SC 1,5 CUS | 1212779 | 1 | | | | | | |
| | | | CRIMPFOX 6T-F CUS | 1212771 | 1 | | | |
| | | | CRIMPFOX 6T CUS | 1212770 | 1 | | | |
| | | | | | | CRIMPFOX-RC1 6 CUS | 1212774 | 1 |
| | | | | | | CRIMPFOX-RC1 6-1 CUS | 1212775 | 1 |
| | | | | | | CRIMPFOX 25R CUS | 1212765 | 1 |
| | | | | | | CRIMPFOX 50R CUS | 1212766 | 1 |

Tools - TOOL fox

CRIMPFOX and WIREFOX pliers, laser marked according to customer specifications



- Customize your crimping and stripping tool!
- You can now use robust laser engraving to mark CRIMPFOX and WIREFOX pliers
- Individual laser marking prevents your tools from being mixed up

Notes:

Matching accessories can be found in main catalog 5 or the product area on our website at phoenixcontact.net/products.

¹⁾ Tools with customer-specific laser marking can be ordered quickly and easily in the product area on our website at phoenixcontact.net/products.

- The advantages of our WIREFOX tools:
- The special spring mechanism helps you to work precisely and safely
 - Ergonomically designed, non-slip handles
 - The WIREFOX pliers automatically adjust to different insulations and conductor diameters
 - Highly adjustable limit stop for the stripping length
 - Practical integrated wire cutter
 - Easily replaceable blade cassettes for different cross sections and insulation

Description

Crimping pliers, for uninsulated cable lugs, three marked die stations, indent crimp, unlockable pressure lock, lateral insertion, **laser marked according to customer specifications¹⁾**

4 - 10 mm²
10 - 25 mm²

Crimping pliers, for uninsulated slip-on sleeves 2.8/4.8/6.3 mm, three marked die stations, 0.5 - 6 mm², B-crimp, unlockable pressure lock, lateral insertion, **laser marked according to customer specifications¹⁾**

Crimping pliers, for ferrules according to DIN 46228, unlockable pressure lock, lateral insertion, **laser marked according to customer specifications¹⁾**

Square crimp, 0.14 - 10 mm²

HEX crimp, 0.14 - 6 mm²

Stripping tool, self-adjusting, easily replaceable blade cassettes, stripping length of up to 18 mm, cutting capacity: up to 1.5 mm² solid, up to 10 mm² stranded, **laser marked according to customer specifications¹⁾**

For cables and conductors from 0.1 - 4 mm², specifically also intended for rubber and other kinds of special insulation

For cables and conductors from 1.5 - 6 mm², specifically for short-circuit-proof cables and rubber insulation

For standard cables and conductors from 0.02 - 10 mm²

For standard cables and conductors from 4 - 16 mm²

TOOLS FOR YOU



TOOLS FOR YOU



TOOLS FOR YOU



| Ordering data | | | Ordering data | | | Ordering data | | |
|--------------------|-----------|-------------|------------------|-----------|-------------|-----------------|-----------|-------------|
| Type | Order No. | Pcs. / Pkt. | Type | Order No. | Pcs. / Pkt. | Type | Order No. | Pcs. / Pkt. |
| CRIMPFOX-RC 10 CUS | 1212776 | 1 | | | | | | |
| CRIMPFOX-RC 25 CUS | 1212778 | 1 | | | | | | |
| CRIMPFOX-SC 6 CUS | 1212780 | 1 | | | | | | |
| | | | CRIMPFOX 10S CUS | 1212764 | 1 | | | |
| | | | CRIMPFOX 6H CUS | 1212768 | 1 | | | |
| | | | | | | WIREFOX 4 CUS | 1212762 | 1 |
| | | | | | | WIREFOX 6SC CUS | 1212763 | 1 |
| | | | | | | WIREFOX 10 CUS | 1212760 | 1 |
| | | | | | | WIREFOX 16 CUS | 1212761 | 1 |



Surge protection for special applications
VAL-MS-AR... Page 306



Surge protection for special applications
VAL-MS-T1/T2... Page 307



Surge protection for NEMA
VAL-SQ NP... Page 309



Surge protection for measurement and control technology
PT-IQ-2X2... Page 310



Surge protection for measurement and control technology
PT-IQ-4X1... Page 310



Surge protection for intrinsically safe circuits
PT-IQ...EX Page 312



Surge protection for information technology
PT-IQ... Page 313



Surge protection for telecommunications interfaces
DT-TELE-SHDSL Page 314



Power supplies
QUINT POWER Page 315



Power supplies
UNO POWER Page 316



Mounting set
BATTERY MOUNTING CASE Page 320



Soldering base element
CB S-BE Page 321



Bridge plug
CB RC BRIDGE Page 321



VAL-MS-AR – surge protection for the American railway industry

The VAL-MS-AR surge protective devices offer reliable, touch-proof protection while also providing a connection block for railway and signaling systems.

The VAL-MS BE-AR... base element has been designed so that the field input and house output connections are on the same side. The ground connection is on the opposite side. The integrated isolator allows you to easily carry out field diagnostics and insulation measurements.

VAL-MS-AR... complies with the practices recommended by AREMA C&S. In contrast to conventional installation with bolts and nuts, the alternative connection technology with base elements and plugs considerably reduces the effort required for installation, tests, and repair measures.

In addition to the standard products, VAL-MS-AR... /FM feature a remote monitoring function. This means that immediate failure or the removal of a protective plug can be signaled via floating contacts.

Features:

- Easy to replace, plug-in surge protection
- Protects systems against direct lightning strikes and coupled surge voltages
- Mechanical status indicator on each protective plug
- Optional remote signaling via floating PDTs
- Integrated isolator for insulation measurements and field diagnostics
- Screw terminal blocks for copper wire up to 4 AWG (25 mm²), solid, stranded, stripped or with sleeves
- Convenient marking options



Field and house connection

Independent terminal points for field and house connection enable wiring from the field side and signal lines with one conductor each. The terminal points are designed for typical wire gauges for railway applications:

House: 20 - 6 AWG (0.5 – 15 mm²),

Field: 18 - 4 AWG (1.5 - 25 mm²).



Disconnect and test point

Integrated isolator for carrying out diagnostics and insulation measurements without tampering with the installation. The disconnect knife remains connected to the field side for testing.



Function monitoring

Each plug has an optical, mechanical status indicator. In the event of a fault, the status is changed via the thermal disconnect device. In the VAL-MS-AR.../FM versions, a floating PDT is thereby switched, so that the status can be remotely indicated.



Protective plug, free of leakage current

VAL-MS...VF... plugs have a series connection consisting of a varistor and a spark gap. The advantage of this component combination is that no leakage currents flow in the passive state and therefore signals are not impaired.



Lightning current plugs with latching

The "T1/T2" plugs are robust enough to cope with direct lightning current. They are heavier than standard plugs and are equipped with latching to keep them in place in the event of vibrations, shocks, and magnetic influences.



Ground and bridging options

The base elements can be easily bridged together with low impedance using pre-assembled MPB bridges. The terminal points for the ground connection accommodate conductors up to 2 AWG (35 mm²).

Surge protection and power supplies

Surge protection and interference filters

VAL-MS-AR surge protection with multifunctional base element

- Base element with isolator for easy field diagnostics and carrying out insulation measurements
- Independent inputs and outputs on one side of the base element, ground connection on the opposite side
- Optical, mechanical status indication for the individual arresters
- Disconnect device on each individual plug
- With or without floating remote indication contact
- Terminal block cases capable of bearing high-current, for solid or stranded conductors that are stripped or with sleeves



Type 1/2 lightning arrester SPD



Type 2 hybrid SPD

Total width 17.7 mm

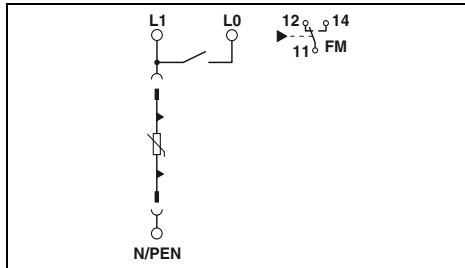

Total width 17.7 mm

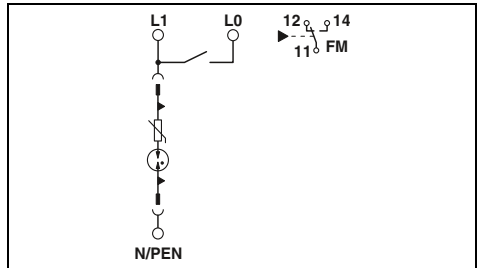

Technical data

| | |
|--|---|
| Electrical data | ... 75 |
| IEC test classification/EN type | I/II/T1/T2 |
| Nominal voltage U_N | 60 V DC |
| Maximum continuous operating voltage U_C | -75 V DC |
| Impulse discharge curr. I_{imp} (10/350)µs | Peak value 12.5 kA |
| | Charge 6.25 As |
| | Specific energy 39.00 kJ/Ω |
| Nominal discharge current I_n (8/20) µs | 12.5 kA |
| Max. discharge current I_{max} (8/20) µs | 50 kA |
| Residual voltage Without reference direction | ≤ 0.6 kV (at 5 kA) |
| Voltage protection level U_p Without reference direction | ≤ 0.7 kV |
| General data | |
| Dimensions W/H/D | 17.7 mm/160 mm/77.5 mm |
| Connection data, Ground solid / stranded / AWG | 1.5 ... 35 mm ² /1.5 ... 35 mm ² /15 - 2 |
| Connection data, Field solid/stranded/AWG | 1.5 ... 25 mm ² /1.5 ... 25 mm ² /12 - 4 |
| Connection data, House solid/stranded/AWG | 0.5 ... 15 mm ² /0.5 ... 15 mm ² /20 - 6 |
| Temperature range | -40°C ... 80°C |
| Inflammability class in acc. with UL 94 | V0 |
| Remote indication contact | PDT, 1-pos. |
| Connection data solid / stranded / AWG | 0.14 ... 1.5 mm ² /0.14 ... 1.5 mm ² /28 - 16 |
| Max. operating voltage | 250 V AC |
| Max. operating current | 1.5 A AC (250 V AC)/1.5 A DC (30 V DC) |

Ordering data

| | | | |
|---|-----------------------|---------|----|
| Description | | | |
| VAL-MS-AR, high-capacity lightning arrester | | | |
| without remote indication contact | VAL-MS-AR-T1/T2 75 | 2801491 | 10 |
| with remote indication contact | VAL-MS-AR-T1/T2 75/FM | 2801492 | 10 |
| VAL-MS-AR, hybrid SPD | | | |
| without remote indication contact | VAL-MS-AR 75 VF | 2801487 | 10 |
| with remote indication contact | VAL-MS-AR 75 VF/FM | 2801488 | 10 |
| without remote indication contact | VAL-MS-AR 350 VF | 2801489 | 10 |
| with remote indication contact | VAL-MS-AR 350 VF/FM | 2801490 | 10 |

Accessories

| | | | | |
|--|------------------------|-------------------------|---------|----|
| Protective plug, for inserting in base element | L-N / L-PEN 1L-N/PE | VAL-MS-T1/T2 75/12.5 ST | 2801146 | 10 |
| Base element, for individual assembly with protective connectors | | VAL-MS BE-AR/FM | 2801066 | 10 |
| with remote indication contact | | VAL-MS BE-AR | 2801065 | 10 |
| without remote indication contact | | FBS 2-18 | 2801068 | 10 |
| Plug-in bridge | | MPB 18/1-57 | 2809238 | 1 |
| 2-pos. | | | | |
| MPB wiring bridge, | | | | |
| 57-pos. | | | | |

Technical data

| | |
|-------------------------|---|
| ... 75 | ... 350 |
| II/T2 | II/T2 |
| 60 V DC (5 V...48 V AC) | 230 V AC |
| 75 V AC/100 V DC | 350 V AC/- |
| 3 kA | 3 kA |
| - | - |
| - | - |
| 10 kA | 10 kA |
| 20 kA | 20 kA |
| ≤ 350 V (at 5 kA) | ≤ 1 kV (at 5 kA) |
| ≤ 1.4 kV | ≤ 1.2 kV |
| | 17.7 mm/160 mm/75 mm |
| | 1.5 ... 35 mm ² /1.5 ... 35 mm ² /15 - 2 |
| | 1.5 ... 25 mm ² /1.5 ... 25 mm ² /12 - 4 |
| | 0.5 ... 15 mm ² /0.5 ... 15 mm ² /20 - 6 |
| | -40°C ... 80°C |
| | V0 |
| | PDT, 1-pos. |
| | 0.14 ... 1.5 mm ² /0.14 ... 1.5 mm ² /28 - 16 |
| | 250 V AC |
| | 1.5 A AC (250 V AC)/1.5 A DC (30 V DC) |

Ordering data

| | | |
|---------------------|-----------|-------------|
| Type | Order No. | Pcs. / Pkt. |
| VAL-MS-AR 75 VF | 2801487 | 10 |
| VAL-MS-AR 75 VF/FM | 2801488 | 10 |
| VAL-MS-AR 350 VF | 2801489 | 10 |
| VAL-MS-AR 350 VF/FM | 2801490 | 10 |

Accessories

| | | |
|------------------|---------|----|
| VAL-MS 75 VF ST | 2805318 | 10 |
| VAL-MS 350 VF ST | 2856595 | 10 |
| VAL-MS BE-AR/FM | 2801066 | 10 |
| VAL-MS BE-AR | 2801065 | 10 |
| FBS 2-18 | 2801068 | 10 |
| MPB 18/1-57 | 2809238 | 1 |

Lightning and surge arresters for 48 V DC applications

- Suitable for the protection of remote radio heads in telecommunications systems
- Extremely low voltage protection level U_p of < 400 V
- Consistent plug-in arresters, type 1/2
- Secure hold of plugs in the event of high lightning current loads and strong vibrations thanks to latching
- Thermal disconnect device for each individual plug
- Optical, mechanical status indication for the individual arresters
- Mechanical coding of all slots
- With or without floating remote indication contact
- Plugs can be checked with CHECKMASTER



Type 1/2 arrester for 48 V DC applications

Total width 35.6 mm

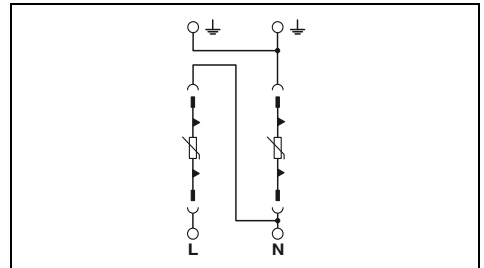

Technical data

| | |
|--|---|
| Electrical data | ... 48 |
| IEC test classification/EN type | I/II/T1/T2 |
| Nominal voltage U_N | 60 V AC |
| Maximum continuous operating voltage U_C | 75 V AC |
| Impulse discharge curr. I_{imp} (10/350) μ s | Peak value 12.5 kA |
| | Charge 6.25 As |
| | Specific energy 39.00 kJ/ Ω |
| Nominal discharge current I_n (8/20) μ s | 12.5 kA |
| Max. discharge current I_{max} (8/20) μ s | 30 kA |
| Voltage protection level U_p | ≤ 0.4 kV |
| Backup fuse max. in acc. with IEC | 160 A (gL/gG) |
| General data | |
| Dimensions W/H/D | 35.6 mm/97 mm/77.5 mm |
| Connection data solid / stranded / AWG | 1.5 ... 35 mm ² /1.5 ... 25 mm ² /15 - 2 |
| Temperature range | -40°C ... 80°C |
| Inflammability class in acc. with UL 94 | V0 |
| Test standards | IEC 61643-11/EN 61643-11/UL 1449 ed. 3 |
| Remote indication contact | PDT, 1-pos. |
| Connection data solid / stranded / AWG | 0.14 ... 1.5 mm ² /0.14 ... 1.5 mm ² /28 - 16 |
| Max. operating voltage | 250 V AC |
| Max. operating current | 1.5 A AC (250 V AC)/1.5 A DC (30 V DC) |

Ordering data

| Description | U_C | Type | Order No. | Pcs. / Pkt. |
|---|---------|------------------------------|-----------|-------------|
| VALVETRAB-MS, varistor-based lightning arrester | | | | |
| | 75 V AC | VAL-MS-T1/T2 48/12.5/1+1V | 2801532 | 1 |
| | 75 V AC | VAL-MS-T1/T2 48/12.5/1+1V-FM | 2801533 | 1 |

Accessories

| Replacement plug | L-N / L-PEN | VAL-MS-T1/T2 48/12.5 ST | 2801242 | 10 |
|------------------|-------------|-----------------------------------|---------|----|
| Marking material | | ZBN 18..., see Catalog 6, page 63 | | |



VAL-SQ NP... provides modular surge protection for an entire house or a small company. The surge protective device consists of a base element and plug. It has the same base area as two standard 1 inch wide circuit breakers to enable installation in the corresponding distributor boxes. Initial installation must be performed by an electrically skilled person. If necessary, the surge protection plug can be replaced by the house owner.

The status indicator on the plug indicates the state of the surge protection. If the protection fails, the VAL-SQ NP... ST protective plug can be replaced quickly and easily. Up to now, components in all other products of this type had to be replaced by an electrically skilled person in the event of a fault.

The high-performance protective circuit features a discharge capacity of 32 kA per phase. The individual protective paths are protected thermally as well as against overcurrent.

The VAL-SQ NP... is suitable for single-phase 120/240 V applications with common neutral conductor and ground.

Distributor box compatibility

VAL-SQ NP can be used in all distribution boxes for single-phase 120/240 AC SN systems with 1 inch pitch.

VAL-SQ NP... devices are compatible with the following distributor boxes:

Eaton

- BR series (prefix 1BR or B) distributor boxes

Siemens Industry, Inc.

- PL series (prefix P, PW or G)
- ES series (prefix S, SW or G)
- EQ series (prefix E or W)

General Electric Co.

- Powermark Gold series (prefix TL, TM or TP)

Schneider Electric USA Inc./ Square D Co.

- Homeline series (prefix HOM)

Surge protection for distributor boxes in houses and small businesses

- Installs in NEMA-style distributor boxes with 1-inch pitch
- Uses the same footprint as two standard 1-inch pitch circuit breakers
- Suitable for single-phase 120/240 V AC systems
- 32 kA surge current capacity per phase
- 10 kA (UL) nominal surge discharge current (I_N)
- LEDs provide continuous feedback on the status of each phase
- UL 1449 3rd edition

Notes:

The products are offered exclusively for export outside the European Economic Area (EEA).



SPD for distributor boxes with 1-inch pitch

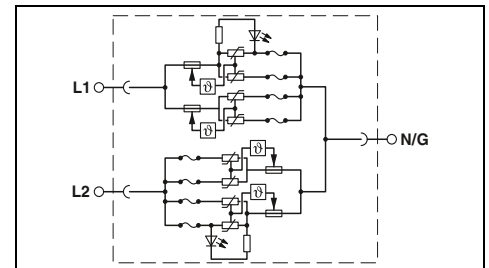

Technical data

| Electrical data | | |
|--|--------------------------|---------------------------------|
| MCOV | L-L / L-N | 350 V/175 V |
| Nominal voltage U_N | | 120 V AC |
| Maximum continuous operating voltage U_C | | 120 V AC |
| Voltage Protection Rating (VPR) | | |
| | L-N / L-PE N-PE / L-L | 800 V/ -/1200 V |
| Short-circuit current rating (SCCR) | | 10 kA |
| Nominal discharge current I_N | | 10 kA |
| General data | | |
| UL Type | | type 1 |
| Degree of protection | | IP20/NEMA 1 |
| Error/status indicator | | LEDs |
| Temperature range | | -55°C ... 70°C |
| Test standards | | UL 1449 3 rd edition |

Ordering data

| Description | Type | Order No. | Pcs. / Pkt. |
|--|----------------------|-----------|-------------|
| Plug and base assembly, 120/240 V AC single phase | | | |
| for distributor boxes with 1-inch pitch | VAL-SQ NP 120-2-A 32 | 2800371 | 1 |

Accessories

| Replacement plug | Type | Order No. | Pcs. / Pkt. |
|---------------------|-------------------------|-----------|-------------|
| Base element | | | |
| | VAL-SQ NP 120-2-A 32 ST | 2800369 | 1 |
| | VAL-SQ NP 120-2-A BE | 2800749 | 1 |

PLUGTRAB PT-IQ

Notes:

For approvals and dimensional drawing, visit phoenixcontact.net/products

- Surge protection system
- Multi-level state monitoring
- Collective message about supply and remote module
- Multi-level, floating remote signaling
- System supplied via DIN rail bus
- Up to 28 protection modules per supply module
- Maximum ease of maintenance, thanks to the two-piece design
- Plugs are coded
- Impedance-neutral disconnection of plug for maintenance purposes
- Base element remains an integral part of the installation



2 double conductors (loops), floating, 9/10 connection grounded directly

Total width 17.7 mm

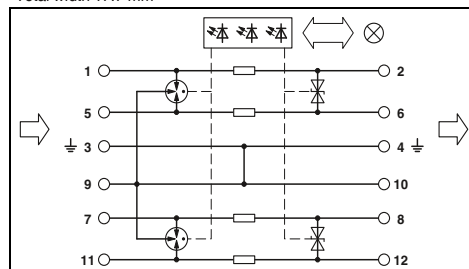

Technical data

| Electrical data | | ... 5DC | ... 48DC |
|--|--|--|--|
| IEC test classification/EN type | | C1/C2/C3/D1 | C1/C2/C3/D1 |
| Maximum continuous operating voltage U_c | | 6 V DC/4 V AC | 53 V DC/37 V AC |
| Impulse discharge curr. I_{imp} (10/350) μ s | | 2.5 kA | 2.5 kA |
| Nominal current I_N | | 700 mA (up to 50°C) | 300 mA |
| Nominal discharge current I_n (8/20) μ s | | | |
| Total surge current (8/20) μ s | | 10 kA/10 kA | 10 kA/10 kA |
| Voltage protection level U_p | | 20 kA | 20 kA |
| Resistance per path | | | |
| | | Core-core | $\leq 25 \text{ V}$ (C3 - 25 A) |
| | | Core-ground | $\leq 600 \text{ V}$ (C1 - 1 kV/500 A) |
| | | | $\leq 90 \text{ V}$ (C3 - 25 A) |
| | | | $\leq 600 \text{ V}$ (C1 - 1 kV/500 A) |
| | | | 1.2 Ω |
| | | | 1.2 Ω |
| General data | | | |
| PT-IQ...PT dimensions W/H/D | | 17.7 mm/109.3 mm/77.5 mm | |
| PT-IQ...UT dimensions W/H/D | | 17.7 mm/91.1 mm/77.5 mm | |
| Connection data, push-in solid/stranded with ferrule/AWG | | 0.2 ... 4 mm ² /0.2 ... 2.5 mm ² /24 - 12 | |
| Connection data solid/stranded with ferrule/AWG | | 0.2 ... 4 mm ² /0.2 ... 2.5 mm ² /24 - 12 | |
| Temperature range | | -40°C ... 70°C | |
| Degree of protection in acc. with IEC 60529/EN 60529 | | IP20 | |
| Inflammability class in acc. with UL 94 | | V0 | |
| Connection method | | Screw connection/push-in connection | |
| Test standards | | EN 61643-21/A1/IEC 61643-21/A1/EN 61000-6-2/ EN 61000-6-2/A1/EN 61000-6-3 | |
| Remote indication contact | | Via TBUS | |

Ordering data

| Description | Voltage U_N | Type | Order No. | Pcs. / Pkt. |
|--|---------------|--------------------------|----------------|-------------|
| MCR-PLUGTRAB , consisting of a plug, base element, and DIN rail bus, with screw connection technology | 5 V DC | PT-IQ-2X2-5DC-UT | 2800807 | 1 |
| | 48 V DC | PT-IQ-2X2-48DC-UT | 2800986 | 1 |
| MCR-PLUGTRAB , consisting of a plug, base element, and DIN rail bus, with push-in connection technology | 5 V DC | PT-IQ-2X2-5DC-PT | 2801259 | 1 |
| | 48 V DC | PT-IQ-2X2-48DC-PT | 2801265 | 1 |

Accessories

| Replacement plug | Type | Order No. | Pcs. / Pkt. |
|------------------|-------------------------|----------------|-------------|
| 5 V DC | PT-IQ-2X2-5DC-P | 2800802 | 1 |
| 48 V DC | PT-IQ-2X2-48DC-P | 2800810 | 1 |

Marking material

ZB 6, see Catalog 6, page 111



**2 double conductors (loops), floating,
9/10 connection grounded
via gas-filled surge**



**4-wire with common reference potential,
9/10 connection grounded directly**



**4-wire with common reference potential,
9/10 connection grounded
via gas-filled surge**

Total width 17.7 mm

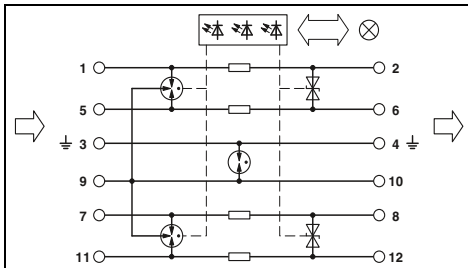

Technical data

| | |
|---------------------------|---------------------------|
| ... 5DC | ... 48DC |
| C1/C2/C3/D1 | C1/C2/C3/D1 |
| 6 V DC/4 V AC | 53 V DC/37 V AC |
| 2.5 kA | 2.5 kA |
| 700 mA (up to 50°C) | 300 mA |
| 10 kA/10 kA | 10 kA/10 kA |
| 20 kA | 20 kA |
| ≤ 25 V (C3 - 25 A) | ≤ 90 V (C3 - 25 A) |
| ≤ 900 V (C1 - 1 kV/500 A) | ≤ 900 V (C1 - 1 kV/500 A) |
| 1.2 Ω | 1.2 Ω |

17.7 mm/109.3 mm/77.5 mm
17.7 mm/91.1 mm/77.5 mm
0.2 ... 4 mm²/0.2 ... 2.5 mm²/24 - 12
0.2 ... 4 mm²/0.2 ... 2.5 mm²/24 - 12

-40°C ... 70°C
IP20
V0

Screw connection/push-in connection

EN 61643-21/A1/IEC 61643-21/A1/EN 61000-6-2/
EN 61000-6-2/A1/EN 61000-6-3
Via TBUS

Ordering data

| Type | Order No. | Pcs. / Pkt. |
|---------------------|-----------|-------------|
| PT-IQ-2X2+F-5DC-UT | 2800809 | 1 |
| PT-IQ-2X2+F-48DC-UT | 2800987 | 1 |
| PT-IQ-2X2+F-5DC-PT | 2801260 | 1 |
| PT-IQ-2X2+F-48DC-PT | 2801266 | 1 |

Accessories

| | | |
|------------------|---------|---|
| PT-IQ-2X2-5DC-P | 2800802 | 1 |
| PT-IQ-2X2-48DC-P | 2800810 | 1 |

ZB 6, see Catalog 6, page 111

Total width 17.7 mm

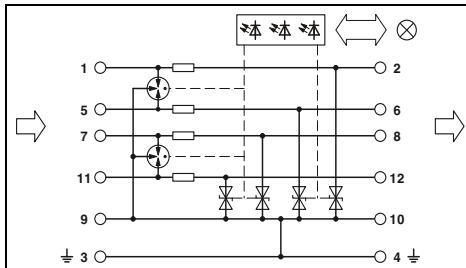

Technical data

| | |
|---------------------|---------------------------|
| ... 5DC | ... 48DC |
| C1/C2/C3/D1 | C1/C2/C3/D1 |
| 6 V DC/4 V AC | 53 V DC/37 V AC |
| 2.5 kA | 2.5 kA |
| 700 mA (up to 50°C) | 300 mA |
| -10 kA | 20 kA |
| ≤ 25 V (C3 - 25 A) | ≤ 900 V (C1 - 1 kV/500 A) |
| 1.2 Ω | 1.2 Ω |

17.7 mm/109.3 mm/77.5 mm
17.7 mm/91.1 mm/77.5 mm
0.2 ... 4 mm²/0.2 ... 2.5 mm²/24 - 12
0.2 ... 4 mm²/0.2 ... 2.5 mm²/24 - 12

-40°C ... 70°C
IP20
V0

Screw connection/push-in connection

EN 61643-21/A1/IEC 61643-21/A1/EN 61000-6-2/
EN 61000-6-2/A1/EN 61000-6-3
Via TBUS

Ordering data

| Type | Order No. | Pcs. / Pkt. |
|------------------|-----------|-------------|
| PT-IQ-4X1-5DC-UT | 2801215 | 1 |
| PT-IQ-4X1-5DC-PT | 2801267 | 1 |

Accessories

| | | |
|-----------------|---------|---|
| PT-IQ-4X1-5DC-P | 2800811 | 1 |
|-----------------|---------|---|

ZB 6, see Catalog 6, page 111

Total width 17.7 mm

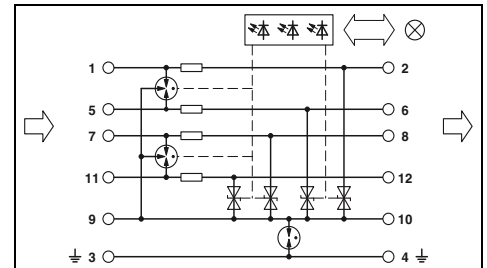

Technical data

| | |
|---------------------------|---------------------------|
| ... 5DC | ... 48DC |
| C1/C2/C3/D1 | C1/C2/C3/D1 |
| 6 V DC/4 V AC | 53 V DC/37 V AC |
| 2.5 kA | 2.5 kA |
| 700 mA (up to 50°C) | 300 mA |
| -10 kA | 20 kA |
| ≤ 720 V (C1 - 1 kV/500 A) | ≤ 900 V (C1 - 1 kV/500 A) |
| 1.2 Ω | 1.2 Ω |

17.7 mm/109.3 mm/77.5 mm
17.7 mm/91.1 mm/77.5 mm
0.2 ... 4 mm²/0.2 ... 2.5 mm²/24 - 12
0.2 ... 4 mm²/0.2 ... 2.5 mm²/24 - 12

-40°C ... 70°C
IP20
V0

Screw connection/push-in connection

EN 61643-21/A1/IEC 61643-21/A1/EN 61000-6-2/
EN 61000-6-2/A1/EN 61000-6-3
Via TBUS

Ordering data

| Type | Order No. | Pcs. / Pkt. |
|--------------------|-----------|-------------|
| PT-IQ-4X1+F-5DC-UT | 2801216 | 1 |
| PT-IQ-4X1+F-5DC-PT | 2801268 | 1 |

Accessories

| | | |
|-----------------|---------|---|
| PT-IQ-4X1-5DC-P | 2800811 | 1 |
|-----------------|---------|---|

ZB 6, see Catalog 6, page 111

Surge protection and power supplies

Surge protection and interference filters

PLUGTRAB PT-IQ EX With screw connection

- Tailored to the special requirements of intrinsically safe circuits
- Surge protection system
- Multi-level state monitoring
- Collective message about supply and remote module
- Multi-level, floating remote signaling
- System supplied via DIN rail bus
- Up to 10 protection modules per supply module
- Maximum ease of maintenance, thanks to the two-piece design
- Plugs are coded
- Impedance-neutral disconnection of plug for maintenance purposes
- Base element remains an integral part of the installation



Double conductor (loop), floating, 9/10 connection grounded directly



2 double conductors (loops), floating, 9/10 connection grounded directly

Total width 17.7 mm

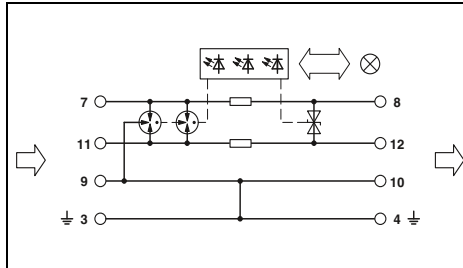

Technical data

| | |
|--|--|
| Electrical data | ... 24DC |
| IEC test classification/EN type | C1/C2/C3/D1 |
| Maximum continuous operating voltage U_C | 30 V DC/21 V AC |
| Impulse discharge curr. I_{imp} (10/350) μ s | 2 kA |
| Nominal current I_N | 350 mA |
| Nominal discharge current I_n (8/20) μ s | 10 kA/10 kA |
| | 20 kA |
| Total surge current (8/20) μ s | |
| Voltage protection level U_p | |
| | Core-core |
| | Core-ground |
| | Core-core |
| | Core-ground |
| Core-ground | ≤ 50 V (C3 - 25 A) |
| | ≤ 1.3 kV (C3 - 100 A) |
| Cut-off frequency f_g (3 dB) | typ. 1.1 MHz |
| | 1.2 Ω |
| Resistance per path | |
| Symmetrical in the 150 Ω system | |
| General data | |
| Dimensions W/H/D | 17.7 mm/91.1 mm/77.5 mm |
| Connection data solid/stranded with ferrule/AWG | 0.2 ... 4 mm ² /0.2 ... 2.5 mm ² /24 - 12 |
| Temperature range | -40°C ... 70°C |
| Degree of protection in acc. with IEC 60529/EN 60529 | IP20 |
| Inflammability class in acc. with UL 94 | V0 |
| Test standards | EN 61643-21/A1/IEC 61643-21/A1/EN 61000-6-2/ EN 61000-6-2/A1/EN 61000-6-3 |
| Remote indication contact | Via TBUS |

Total width 17.7 mm

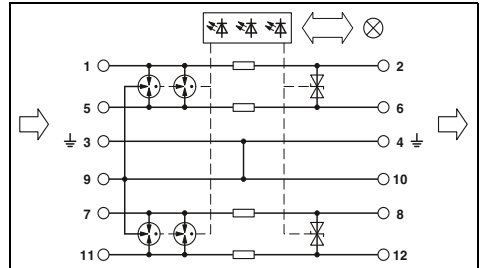

Technical data

| | |
|--|---------------|
| Description | Voltage U_N |
| MCR-PLUGTRAB, consisting of a plug, base element, and DIN rail bus, with screw connection technology | 24 V DC |
| Replacement plug | 24 V DC |
| Separating plate for DIN rail NS35/7.5 | |
| for DIN rail NS35/15 | |
| Marking material | |

Ordering data

| Type | Order No. | Pcs. / Pkt. |
|----------------------|-----------|-------------|
| PT-IQ-1X2-EX-24DC-UT | 2801512 | 1 |

Accessories

| | | |
|---------------------|---------|---|
| PT-IQ-1X2-EX-24DC-P | 2801514 | 1 |
| PT-IQ-EX-L-PP | 2905023 | 1 |
| PT-IQ-EX-H-PP | 2905024 | 1 |

ZB 6, see Catalog 6, page 111

Ordering data

| Type | Order No. | Pcs. / Pkt. |
|----------------------|-----------|-------------|
| PT-IQ-2X2-EX-24DC-UT | 2801513 | 1 |

Accessories

| | | |
|---------------------|---------|---|
| PT-IQ-2X2-EX-24DC-P | 2801515 | 1 |
| PT-IQ-EX-L-PP | 2905023 | 1 |
| PT-IQ-EX-H-PP | 2905024 | 1 |

ZB 6, see Catalog 6, page 111

PLUGTRAB PT-IQ

- Surge protection system
- Multi-level state monitoring
- Collective message about supply and remote module
- Multi-level, floating remote signaling
- System supplied via DIN rail bus
- Up to 28 protection modules per supply module
- Maximum ease of maintenance thanks to the two-piece design
- Plugs are coded
- Impedance-neutral disconnection of plug for maintenance purposes
- Base element remains an integral part of the installation

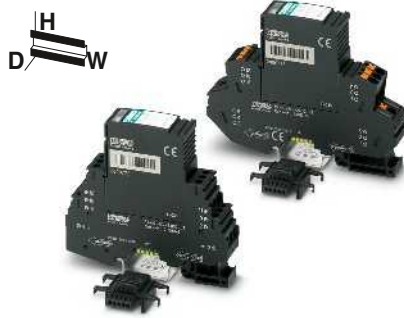

3-wire with common reference potential, 9/10 connection grounded directly

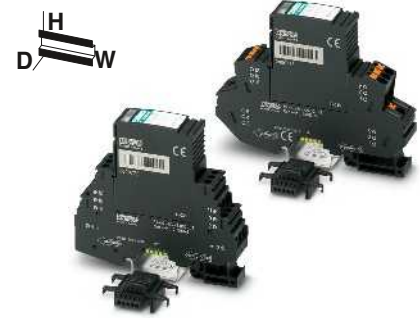

3-wire with common reference potential, 9/10 connection grounded via gas-filled surge

Total width 17.7 mm

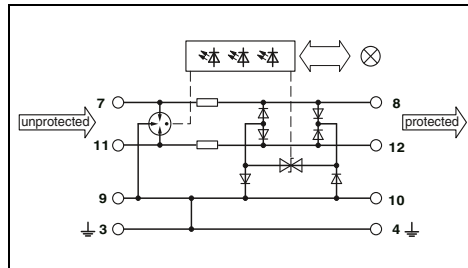

Total width 17.7 mm

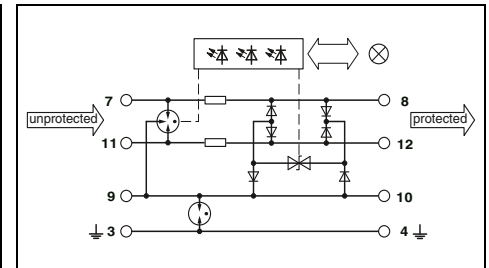

Technical data

| | | |
|--|--|---|
| Electrical data | ... 5DC | ... 12DC |
| IEC test classification/EN type | C1/C2/C3/D1 | C1/C2/C3/D1 |
| Maximum continuous operating voltage U_C | 6 V DC/4 V AC | 15 V DC/10 V AC |
| Impulse discharge curr. I_{imp} (10/350) μ s | 2.5 kA | 2.5 kA |
| Nominal current I_N | 600 mA (up to 40°C) | 600 mA (up to 40°C) |
| Nominal discharge current I_n (8/20) μ s | | |
| Total surge current (8/20) μ s | 10 kA/10 kA | 10 kA/10 kA |
| Voltage protection level U_p | 20 kA | 20 kA |
| | Core-core | Core-ground |
| | ≤ 30 V (C3 - 25 A) | ≤ 40 V (C3 - 25 A) |
| | Core-ground | Core-ground |
| | ≤ 30 V (C3 - 25 A) | ≤ 40 V (C3 - 25 A) |
| Cut-off frequency f_g (3 dB) | Symmetrical in the 150 Ω system | > 60 MHz |
| General data | | > 60 MHz |
| PT-IQ...PT dimensions W/H/D | | 17.7 mm/109.3 mm/77.5 mm |
| PT-IQ...UT dimensions W/H/D | | 17.7 mm/91.1 mm/77.5 mm |
| Connection data, push-in solid/stranded with ferrule/AWG | | 0.2 ... 4 mm ² /0.2 ... 2.5 mm ² /24 - 12 |
| Connection data solid/stranded with ferrule/AWG | | 0.2 ... 4 mm ² /0.2 ... 2.5 mm ² /24 - 12 |
| Temperature range | | -40°C ... 70°C |
| Degree of protection in acc. with IEC 60529/EN 60529 | | IP20 |
| Inflammability class in acc. with UL 94 | | V0 |
| Connection method | | Screw connection/push-in connection |
| Test standards | | EN 61643-21/A1/IEC 61643-21/A2/EN 61000-6-2/A1/EN 61000-6-3 |

Technical data

| | | |
|--|--|---|
| Electrical data | ... 5DC | ... 12DC |
| IEC test classification/EN type | C1/C2/C3/D1 | C1/C2/C3/D1 |
| Maximum continuous operating voltage U_C | 6 V DC/4 V AC | 15 V DC/10 V AC |
| Impulse discharge curr. I_{imp} (10/350) μ s | 2.5 kA | 2.5 kA |
| Nominal current I_N | 600 mA (up to 40°C) | 600 mA (up to 40°C) |
| Nominal discharge current I_n (8/20) μ s | | |
| Total surge current (8/20) μ s | 10 kA/10 kA | 10 kA/10 kA |
| Voltage protection level U_p | 20 kA | 20 kA |
| | Core-core | Core-ground |
| | ≤ 30 V (C3 - 25 A) | ≤ 40 V (C3 - 25 A) |
| | Core-ground | Core-ground |
| | ≤ 900 V (C3 - 25 A) | ≤ 900 V (C3 - 25 A) |
| Cut-off frequency f_g (3 dB) | Symmetrical in the 150 Ω system | > 60 MHz |
| General data | | > 60 MHz |
| PT-IQ...PT dimensions W/H/D | | 17.7 mm/109.3 mm/77.5 mm |
| PT-IQ...UT dimensions W/H/D | | 17.7 mm/91.1 mm/77.5 mm |
| Connection data, push-in solid/stranded with ferrule/AWG | | 0.2 ... 4 mm ² /0.2 ... 2.5 mm ² /24 - 12 |
| Connection data solid/stranded with ferrule/AWG | | 0.2 ... 4 mm ² /0.2 ... 2.5 mm ² /24 - 12 |
| Temperature range | | -40°C ... 70°C |
| Degree of protection in acc. with IEC 60529/EN 60529 | | IP20 |
| Inflammability class in acc. with UL 94 | | V0 |
| Connection method | | Screw connection/push-in connection |
| Test standards | | EN 61643-21/A1/IEC 61643-21/A2/EN 61000-6-2/A1/EN 61000-6-3 |

Ordering data

| Description | Voltage U_N |
|--|-------------------|
| MCR-PLUGTRAB, consisting of a plug, base element, and DIN rail bus, with screw connection technology | 5 V DC 12 V DC |
| MCR-PLUGTRAB, consisting of a plug, base element, and DIN rail bus, with push-in connection technology | 5 V DC 12 V DC |

| Type | Order No. | Pcs. / Pkt. |
|--------------------|-----------|-------------|
| PT-IQ-3-PB-UT | 2800785 | 1 |
| PT-IQ-3-HF-12DC-UT | 2800786 | 1 |
| PT-IQ-3-PB-PT | 2801286 | 1 |
| PT-IQ-3-HF-12DC-PT | 2801288 | 1 |

Ordering data

| Type | Order No. | Pcs. / Pkt. |
|----------------------|-----------|-------------|
| PT-IQ-3-PB+F-UT | 2800994 | 1 |
| PT-IQ-3-HF+F-12DC-UT | 2800995 | 1 |
| PT-IQ-3-PB+F-PT | 2801287 | 1 |
| PT-IQ-3-HF+F-12DC-PT | 2801289 | 1 |

Accessories

| Replacement plug |
|------------------|
| 5 V DC |
| 12 V DC |

| Type | Order No. | Pcs. / Pkt. |
|-------------------|-----------|-------------|
| PT-IQ-3-PB-P | 2800783 | 1 |
| PT-IQ-3-HF-12DC-P | 2800784 | 1 |

Accessories

| Type | Order No. | Pcs. / Pkt. |
|-------------------|-----------|-------------|
| PT-IQ-3-PB-P | 2800783 | 1 |
| PT-IQ-3-HF-12DC-P | 2800784 | 1 |

Marking material

ZB 6, see Catalog 6, page 111

ZB 6, see Catalog 6, page 111

Surge protection and power supplies

Surge protection and interference filters

Surge protection for SHDSL telecommunications interfaces

- Protection for two SHDSL ports
- Connection: RJ45 (RJ12/RJ11) and plug-in screw terminal block (COMBICON)
- Alternatively, can be snapped onto a DIN rail
- Protective circuit: Course/fine protection combination between all cables of signal wire pairs, as well as common mode voltage coarse protection between all signal wires and ground
- Separate ground connection line
- The adapter included enables conversion from RJ45 to RJ11 and RJ12 (for contacting, see circuit diagram)



Attachment plug for two SHDSL interfaces (ports)

Total width 25 mm

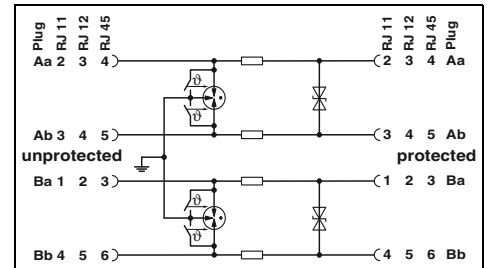

Technical data

| Electrical data | | |
|--|-----------------------|---|
| IEC test classification/EN type | | B2/C1/C2/C3/D1 |
| Maximum continuous operating voltage U_c | | 185 V DC |
| Nominal current I_N | | ≤ 380 mA (25°C) |
| Nominal discharge current I_n (8/20) μ s | Core-core/core-ground | ≤ 5 kA/≤ 5 kA |
| Total surge current (8/20) μ s | | 10 kA |
| Voltage protection level U_p | Core-core/core-ground | ≤ 250 V (C1 - 500 A)/≤ 580 V (C1 - 500 A) |
| Cut-off frequency fg (3 dB) | Core-core | 25 MHz |
| In a 100 Ω system | | |
| General data | | |
| Dimensions W/H/D | | 25 mm/103 mm/63 mm |
| Connection data solid / stranded / AWG | | 0.14 ... 1.5 mm ² /0.14 ... 1.5 mm ² /28 - 16 |
| Temperature range | | -40°C ... 85°C |
| Degree of protection in acc. with IEC 60529/EN 60529 | | IP20 |
| Connection method | | RJ45/Combicon |
| Test standards | | IEC 61643-21 |

Ordering data

| Description | Type | Order No. | Pcs. / Pkt. |
|---|----------------------|----------------|-------------|
| DATATRAB adapter , protective adapter with RJ45 and screw connection for two SHDSL telecommunications interfaces | DT-TELE-SHDSL | 2801593 | 1 |

QUINT POWER power supplies - with maximum functionality

- AC and DC input in a single device
- Specially designed for connection to two outer conductors of a three-phase system and to a DC intermediate circuit voltage of an inverter; typical applications include injection molding machines.
- Starts up with two-phase AC voltage or DC voltage. In the event of a mains failure connected 24 V loads continue to be supplied using the kinetic energy of the motor. In this way, the motor acts as a generator and supplies energy to the intermediate circuits as long as it is moving.
- Fast tripping of standard circuit breakers with dynamic power reserve SFB (selective fuse breaking) technology with up to 6 times the nominal current for 20 ms
- Reliably start difficult loads with the static POWER BOOST power reserve
- Preventive function monitoring warns against critical operating states before errors occur.



Power supply with two separate input circuits for frequency inverters
2 AC, 1 DC/24 V DC, 20 A

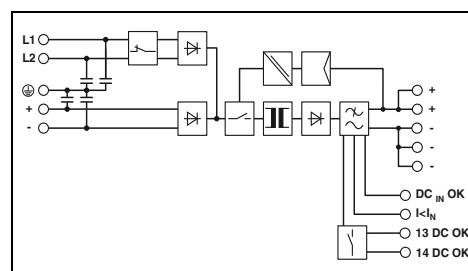

Technical data

| | | |
|------------------------------|--|---|
| Input data of AC | Nominal input voltage range Input voltage range AC Frequency range Current consumption (nominal load) Inrush current limitation at 25°C (typ.) / I ² t Mains buffering (I _N , typ.) | 2x 400 V AC ... 500 V AC 2x 360 V AC ... 575 V AC 45 Hz ... 65 Hz 2.5 A (400 V AC)/2.1 A (500 V AC) < 85 A/ \leq 1.5 A ² s > 20 ms (400 V AC) |
| Input data of DC | Nominal input voltage range Input voltage range DC Max. current consumption | 600 V DC 450 V DC ... 840 V DC approx. 0.9 A (600 V DC) |
| Output data | Nominal output voltage Setting range of the output voltage | 24 V DC \pm 1% 18 V DC ... 29.5 V DC (U _{IN} \geq 360 V AC/480 V DC) 18 V DC ... 26 V DC (< 480 V DC) 20 A/26 A/120 A |
| | Output current/POWER BOOST/SFB (20 ms) Magnetic fuse tripping Can be connected in parallel/series Max. power dissipation (no load/nominal load) Efficiency (typ.) Residual ripple | - Yes/Yes 11 W/51 W > 92% (600 V DC) < 50 mV _{PP} |
| Signaling | Signaling DC OK Boost signaling | LED, relay contact LED, active switching output |
| General data | Weight/dimensions W x H x D Spacing when mounting | 2 kg/120 x 130 x 125 mm Alignable: 5 mm horizontally, 15 mm next to active components, 50 mm vertically Screw connection |
| | Connection method Input connection data (solid/stranded/AWG) Output connection data (solid/stranded/AWG) Signal connection data (solid/stranded/AWG) Degree of protection/protection class MTBF (EN 29500, 40°C) Ambient temperature (operation) | 0.2 - 6 mm ² /0.2 - 4 mm ² /24 - 10 0.2 - 6 mm ² /0.2 - 4 mm ² /12 - 10 0.2 - 6 mm ² /0.2 - 4 mm ² /24 - 10 IP20/I > 500000 h -25°C ... 70°C (> 60°C derating) |
| Standards/regulations | Insulation voltage input/output | 2 kV AC (routine test)/1.5 kV AC (type test) |
| | Electromagnetic compatibility Electrical safety Electronic equipm. for electrical power installations Safe isolation UL approvals | Conformance with EMC Directive 2004/108/EC EN 60950-1/VDE 0805 (SELV) EN 50178/VDE 0160 (PELV) DIN VDE 0100-410 UL applied for |

Ordering data

| Description | Type | Order No. | Pcs. / Pkt. |
|--|--------------------------|-----------|-------------|
| DC-DC converter, primary switched mode | QUINT-PS/2AC/1DC/24DC/20 | 2320830 | 1 |

Surge protection and power supplies

Power supplies and UPS

UNO POWER power supplies - with basic functionality

- Save energy, thanks to particularly low idling losses and a high degree of efficiency
- Save space in the control cabinet through compact housing with high power density
- Robust and reliable at temperatures from -25 to 70°C

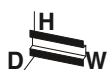

Power supply,
1 AC, 5 DC, 25 W



Power supply,
1 AC, 5 DC, 40 W

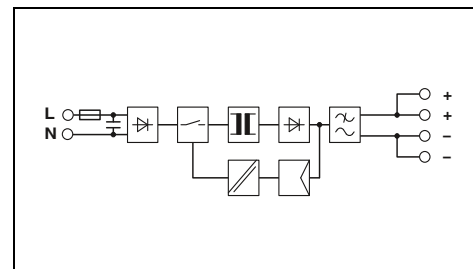
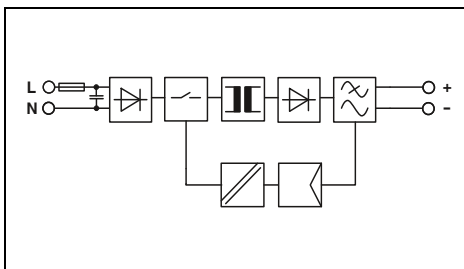

Technical data

Technical data

| | |
|---|---|
| Input data | |
| Nominal input voltage range | 100 V AC ... 240 V AC |
| Input voltage range AC/DC | 85 V AC ... 264 V AC |
| Frequency range | 45 Hz ... 65 Hz |
| Current consumption (nominal load) | 0.5 A (120 V AC)/0.3 A (230 V AC) |
| Inrush current limitation at 25°C (typ.) / I ² t | < 30 A/< 0.5 A ² s |
| Mains buffering (I _N , typ.) | > 35 ms (120 V AC)/> 135 ms (230 V AC) |
| Output data | |
| Nominal output voltage | 5 V DC ±1% |
| Output current | 5 A |
| Can be connected in parallel/series | Yes, with redundancy module/Yes |
| Max. power dissipation (no load/nominal load) | < 0.3 W/< 4.5 W |
| Efficiency (typ.) | > 84% |
| Residual ripple | < 40 mV _{pp} |
| Signaling | |
| Signaling DC OK | LED |
| General data | |
| Weight/dimensions W x H x D | 0.15 kg/22.5 x 90 x 84 mm |
| Spacing when mounting | Alignable: 0 mm horizontally, 30 mm vertically |
| Connection method | Screw connection |
| Connection data solid / stranded / AWG | 0.2 - 2.5 mm ² /0.2 - 2.5 mm ² /24 - 14 |
| Degree of protection / Protection class | IP20/II |
| MTBF (EN 29500, 40°C) | > 500000 h |
| Ambient temperature (operation) | -25°C ... 70°C (> 55° C derating) |
| Standards/regulations | |
| Insulation voltage input/output | 3 kV AC (routine test)/4 kV AC (type test) |
| Electromagnetic compatibility | Conformance with EMC Directive 2004/108/EC |
| Electrical safety | IEC 60950-1/VDE 0805 (SELV) |
| Electronic equipm. for electrical power installations | EN 50178/VDE 0160 (PELV) |
| Safe isolation | DIN VDE 0100-410 |
| UL approvals | UL/C-UL listed UL 508, UL/C-UL Recognized UL 60950 |
| Limitation of harmonic line currents | |
| | EN 61000-3-2 |

| | |
|---|---|
| Technical data | |
| Nominal input voltage range | 100 V AC ... 240 V AC |
| Input voltage range AC/DC | 85 V AC ... 264 V AC |
| Frequency range | 45 Hz ... 65 Hz |
| Current consumption (nominal load) | 0.5 A (120 V AC)/0.3 A (230 V AC) |
| Inrush current limitation at 25°C (typ.) / I ² t | < 30 A/< 0.5 A ² s |
| Mains buffering (I _N , typ.) | > 35 ms (120 V AC)/> 135 ms (230 V AC) |
| Output data | |
| Nominal output voltage | 5 V DC ±1% |
| Output current | 8 A |
| Can be connected in parallel/series | Yes, with redundancy module/Yes |
| Max. power dissipation (no load/nominal load) | < 0.3 W/< 7.5 W |
| Efficiency (typ.) | > 85% (for 230 V AC and nominal values) |
| Residual ripple | < 100 mV _{pp} |
| Signaling | |
| Signaling DC OK | LED |
| General data | |
| Weight/dimensions W x H x D | 0.21 kg/35 x 90 x 84 mm |
| Spacing when mounting | Alignable: 0 mm horizontally, 30 mm vertically |
| Connection method | Screw connection |
| Connection data solid / stranded / AWG | 0.2 - 2.5 mm ² /0.2 - 2.5 mm ² /24 - 14 |
| Degree of protection / Protection class | IP20/II |
| MTBF (EN 29500, 40°C) | > 500000 h |
| Ambient temperature (operation) | -25°C ... 70°C (> 55° C derating) |
| Standards/regulations | |
| Insulation voltage input/output | 3 kV AC (routine test)/4 kV AC (type test) |
| Electromagnetic compatibility | Conformance with EMC Directive 2004/108/EC |
| Electrical safety | IEC 60950-1/VDE 0805 (SELV) |
| Electronic equipm. for electrical power installations | EN 50178/VDE 0160 (PELV) |
| Safe isolation | DIN VDE 0100-410 |
| UL approvals | UL/C-UL listed UL 508, UL/C-UL Recognized UL 60950 |
| Limitation of harmonic line currents | |
| | EN 61000-3-2 |

| | |
|---|---|
| Technical data | |
| Nominal input voltage range | 100 V AC ... 240 V AC |
| Input voltage range AC/DC | 85 V AC ... 264 V AC |
| Frequency range | 45 Hz ... 65 Hz |
| Current consumption (nominal load) | 0.7 A (120 V AC)/0.5 A (230 V AC) |
| Inrush current limitation at 25°C (typ.) / I ² t | < 30 A/< 0.5 A ² s |
| Mains buffering (I _N , typ.) | > 30 ms (120 V AC)/> 120 ms (230 V AC) |
| Output data | |
| Nominal output voltage | 5 V DC ±1% |
| Output current | 8 A |
| Can be connected in parallel/series | Yes, with redundancy module/Yes |
| Max. power dissipation (no load/nominal load) | < 0.3 W/< 7.5 W |
| Efficiency (typ.) | > 85% (for 230 V AC and nominal values) |
| Residual ripple | < 100 mV _{pp} |
| Signaling | |
| Signaling DC OK | LED |
| General data | |
| Weight/dimensions W x H x D | 0.21 kg/35 x 90 x 84 mm |
| Spacing when mounting | Alignable: 0 mm horizontally, 30 mm vertically |
| Connection method | Screw connection |
| Connection data solid / stranded / AWG | 0.2 - 2.5 mm ² /0.2 - 2.5 mm ² /24 - 14 |
| Degree of protection / Protection class | IP20/II |
| MTBF (EN 29500, 40°C) | > 500000 h |
| Ambient temperature (operation) | -25°C ... 70°C (> 55° C derating) |
| Standards/regulations | |
| Insulation voltage input/output | 3 kV AC (routine test)/4 kV AC (type test) |
| Electromagnetic compatibility | Conformance with EMC Directive 2004/108/EC |
| Electrical safety | IEC 60950-1/VDE 0805 (SELV) |
| Electronic equipm. for electrical power installations | EN 50178/VDE 0160 (PELV) |
| Safe isolation | DIN VDE 0100-410 |
| UL approvals | UL/C-UL listed UL 508, UL/C-UL Recognized UL 60950 |
| Limitation of harmonic line currents | |
| | EN 61000-3-2 |

Ordering data

Ordering data

| Description | Type | Order No. | Pcs. / Pkt. |
|---|----------------------|-----------|-------------|
| Power supply, primary-switched, 1-phase | UNO-PS/1AC/ 5DC/ 25W | 2904374 | 1 |

| Description | Type | Order No. | Pcs. / Pkt. |
|---|----------------------|-----------|-------------|
| Power supply, primary-switched, 1-phase | UNO-PS/1AC/ 5DC/ 40W | 2904375 | 1 |



Power supply,
1 AC, 12 DC, 100 W



Power supply,
1 AC, 15 DC, 30 W



Power supply,
1 AC, 15 DC, 55 W

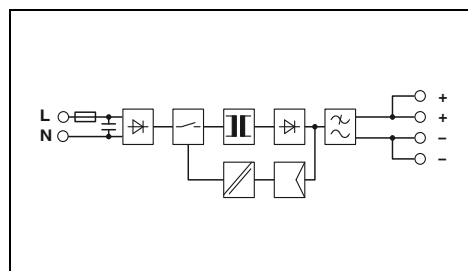
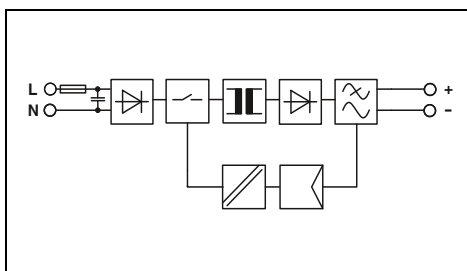
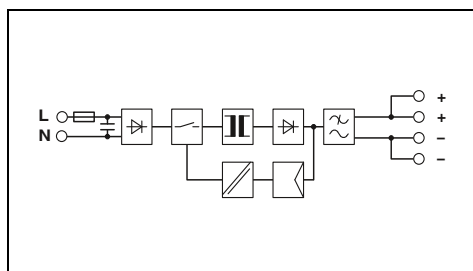

Technical data

100 V AC ... 240 V AC
85 V AC ... 264 V AC
45 Hz ... 65 Hz
1.7 A (120 V AC)/1 A (230 V AC)
< 30 A/< 1.5 A²s
> 20 ms (120 V AC)/> 85 ms (230 V AC)

12 V DC ±1%
8.3 A
Yes, with redundancy module/Yes
< 0.4 W/< 12 W
> 89.5%
< 75 mV_{pp}

LED

0.34 kg/55 x 90 x 84 mm
Alignable: 0 mm horizontally, 30 mm vertically
Screw connection
0.2 - 2.5 mm²/0.2 - 2.5 mm²/24 - 14
IP20/II
> 500000 h
-25°C ... 70°C (> 55° C derating)

3 kV AC (routine test)/4 kV AC (type test)
Conformance with EMC Directive 2004/108/EC
IEC 60950-1/VDE 0805 (SELV)
EN 50178/VDE 0160 (PELV)
DIN VDE 0100-410
UL/C-UL listed UL 508, UL/C-UL Recognized UL 60950

EN 61000-3-2

Technical data

100 V AC ... 240 V AC
85 V AC ... 264 V AC
45 Hz ... 65 Hz
0.6 A (120 V AC)/0.4 A (230 V AC)
< 30 A/< 0.3 A²s
> 20 ms (120 V AC)/> 115 ms (230 V AC)

15 V DC ±1%
2 A
Yes, with redundancy module/Yes
< 0.3 W/< 4.6 W
> 87% (for 230 V AC and nominal values)
< 40 mV_{pp}

LED

0.15 kg/22.5 x 90 x 84 mm
Alignable: 0 mm horizontally, 30 mm vertically
Screw connection
0.2 - 2.5 mm²/0.2 - 2.5 mm²/24 - 14
IP20/II
> 500000 h
-25°C ... 70°C (> 55° C derating)

3 kV AC (routine test)/4 kV AC (type test)
Conformance with EMC Directive 2004/108/EC
IEC 60950-1/VDE 0805 (SELV)
EN 50178/VDE 0160 (PELV)
DIN VDE 0100-410
UL/C-UL listed UL 508, UL/C-UL Recognized UL 60950

EN 61000-3-2

Technical data

100 V AC ... 240 V AC
85 V AC ... 264 V AC
45 Hz ... 65 Hz
1 A (120 V AC)/0.6 A (230 V AC)
< 25 A/< 0.5 A²s
> 25 ms (120 V AC)/> 90 ms (230 V AC)

15 V DC ±1%
3.7 A
Yes, with redundancy module/Yes
< 0.3 W/< 7 W
> 88.5% (for 230 V AC and nominal values)
< 50 mV_{pp}

LED

0.21 kg/35 x 90 x 84 mm
Alignable: 0 mm horizontally, 30 mm vertically
Screw connection
0.2 - 2.5 mm²/0.2 - 2.5 mm²/24 - 14
IP20/II
> 500000 h
-25°C ... 70°C (> 55° C derating)

3 kV AC (routine test)/4 kV AC (type test)
Conformance with EMC Directive 2004/108/EC
IEC 60950-1/VDE 0805 (SELV)
EN 50178/VDE 0160 (PELV)
DIN VDE 0100-410
UL/C-UL listed UL 508, UL/C-UL Recognized UL 60950

EN 61000-3-2

Ordering data

| Type | Order No. | Pcs. / Pkt. |
|----------------------|-----------|-------------|
| UNO-PS/1AC/12DC/100W | 2902997 | 1 |

Ordering data

| Type | Order No. | Pcs. / Pkt. |
|---------------------|-----------|-------------|
| UNO-PS/1AC/15DC/30W | 2903000 | 1 |

Ordering data

| Type | Order No. | Pcs. / Pkt. |
|---------------------|-----------|-------------|
| UNO-PS/1AC/15DC/55W | 2903001 | 1 |

Surge protection and power supplies

Power supplies and UPS

UNO POWER power supplies - with basic functionality

- Save energy, thanks to particularly low idling losses and a high degree of efficiency
- Save space in the control cabinet through compact housing with high power density
- Robust and reliable at temperatures from -25 to 70°C



Power supply,
1 AC, 15 DC, 100 W



Power supply,
1 AC, 24 DC, 90 W
NEC Class 2

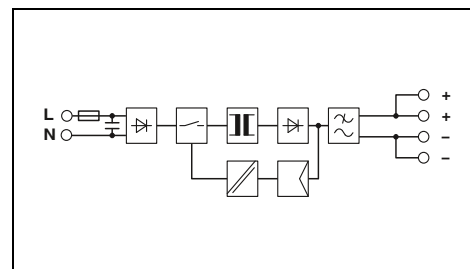
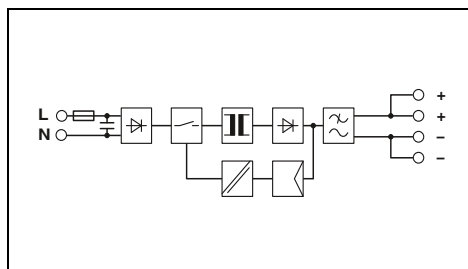

Technical data

| |
|---|
| Input data |
| Nominal input voltage range |
| Input voltage range AC/DC |
| Frequency range |
| Current consumption (nominal load) |
| Inrush current limitation at 25°C (typ.) / I ² t |
| Mains buffering (I _N , typ.) |
| Output data |
| Nominal output voltage |
| Output current |
| Can be connected in parallel/series |
| Max. power dissipation (no load/nominal load) |
| Efficiency (typ.) |
| Residual ripple |
| Signaling |
| Signaling DC OK |
| General data |
| Weight/dimensions W x H x D |
| Spacing when mounting |
| Connection method |
| Connection data solid / stranded / AWG |
| Degree of protection / Protection class |
| MTBF (EN 29500, 40°C) |
| Ambient temperature (operation) |
| Standards/regulations |
| Insulation voltage input/output |
| Electromagnetic compatibility |
| Electrical safety |
| Electronic equipm. for electrical power installations |
| Safe isolation |
| UL approvals |
| Limitation of harmonic line currents |

| |
|---|
| 100 V AC ... 240 V AC |
| 85 V AC ... 264 V AC |
| 45 Hz ... 65 Hz |
| 1.7 A (120 V AC)/1 A (230 V AC) |
| < 30 A/< 1.5 A ² s |
| > 20 ms (120 V AC)/> 85 ms (230 V AC) |
| 15 V DC ±1% |
| 6.67 A |
| Yes, with redundancy module/Yes |
| < 0.4 W/< 12 W |
| > 89% (for 230 V AC and nominal values) |
| < 75 mV _{pp} |
| LED |
| 0.34 kg/55 x 90 x 84 mm |
| Alignable: 0 mm horizontally, 30 mm vertically |
| Screw connection |
| 0.2 - 2.5 mm ² /0.2 - 2.5 mm ² /24 - 12 |
| IP20/II |
| > 500000 h |
| -25°C ... 70°C (> 55°C derating) |
| 3 kV AC (routine test)/4 kV AC (type test) |
| Conformance with EMC Directive 2004/108/EC |
| IEC 60950-1/VDE 0805 (SELV) |
| EN 50178/VDE 0160 (PELV) |
| DIN VDE 0100-410 |
| UL/C-UL listed UL 508, UL/C-UL Recognized UL 60950 |
| EN 61000-3-2 |

Technical data

| |
|--|
| 100 V AC ... 240 V AC |
| 85 V AC ... 264 V AC |
| 45 Hz ... 65 Hz |
| 1.5 A (120 V AC)/1 A (230 V AC) |
| < 40 A/< 1.5 A ² s |
| > 25 ms (120 V AC)/> 100 ms (230 V AC) |
| 24 V DC ±1% |
| 3.75 A |
| Yes, with redundancy module/Yes |
| < 0.5 W/< 12 W |
| > 88.5% (for 230 V AC and nominal values) |
| < 45 mV _{pp} |
| LED |
| 0.34 kg/55 x 90 x 84 mm |
| Alignable: 0 mm horizontally, 30 mm vertically |
| Screw connection |
| 0.2 - 2.5 mm ² /0.2 - 2.5 mm ² /24 - 14 |
| IP20/II |
| > 500000 h |
| -25°C ... 70°C (> 55°C derating) |
| 3 kV AC (routine test)/4 kV AC (type test) |
| Conformance with EMC Directive 2004/108/EC |
| IEC 60950-1/VDE 0805 (SELV) |
| EN 50178/VDE 0160 (PELV) |
| DIN VDE 0100-410 |
| UL/C-UL listed UL 508, UL/C-UL Recognized UL 60950, NEC Class 2 as per UL 1310 |
| EN 61000-3-2 |

Ordering data

| Description | Type | Order No. | Pcs. / Pkt. |
|---|----------------------|-----------|-------------|
| Power supply, primary-switched, 1-phase | UNO-PS/1AC/15DC/100W | 2903002 | 1 |

Ordering data

| Description | Type | Order No. | Pcs. / Pkt. |
|---|---------------------------|-----------|-------------|
| Power supply, primary-switched, 1-phase | UNO-PS/1AC/24DC/90W/C2LPS | 2902994 | 1 |



Power supply,
1 AC, 48 DC, 60 W

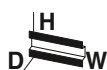

Power supply,
1 AC, 48 DC, 100 W



Power supply,
2 AC, 24 DC, 90 W
NEC Class 2

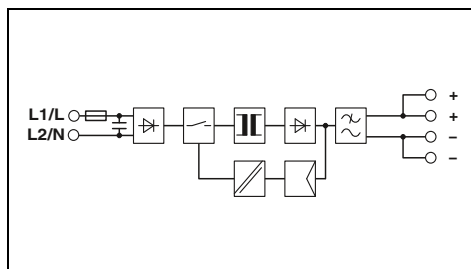
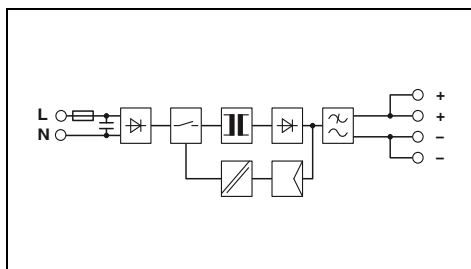
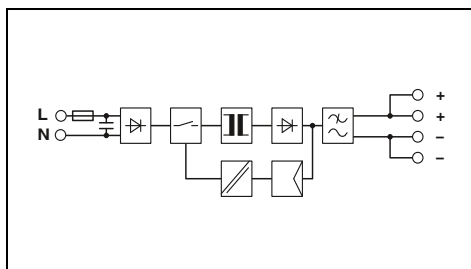

Technical data

100 V AC ... 240 V AC
85 V AC ... 264 V AC
45 Hz ... 65 Hz
1 A (120 V AC)/0.6 A (230 V AC)
< 30 A/< 0.5 A²s
> 20 ms (120 V AC)/> 90 ms (230 V AC)

48 V DC ±1%
1.25 A
Yes, with redundancy module/Yes
< 0.4 W/< 7 W
> 90% (for 230 V AC and nominal values)
< 35 mV_{pp}

LED

0.21 kg/35 x 90 x 84 mm
Alignable: 0 mm horizontally, 30 mm vertically
Screw connection
0.2 - 2.5 mm²/0.2 - 2.5 mm²/24 - 14
IP20/II
> 500000 h
-25°C ... 70°C (> 55° C derating)

3 kV AC (routine test)/4 kV AC (type test)
Conformance with EMC Directive 2004/108/EC
IEC 60950-1/VDE 0805 (SELV)
EN 50178/VDE 0160 (PELV)
DIN VDE 0100-410
UL/C-UL listed UL 508, UL/C-UL Recognized UL 60950

EN 61000-3-2

Technical data

100 V AC ... 240 V AC
85 V AC ... 264 V AC
45 Hz ... 65 Hz
1.7 A (120 V AC)/1 A (230 V AC)
< 40 A/< 1.4 A²s
> 25 ms (120 V AC)/> 90 ms (230 V AC)

48 V DC ±1%
2.08 A
Yes, with redundancy module/Yes
< 0.4 W/< 11 W
> 90% (for 230 V AC and nominal values)
< 40 mV_{pp}

LED

0.34 kg/55 x 90 x 84 mm
Alignable: 0 mm horizontally, 30 mm vertically
Screw connection
0.2 - 2.5 mm²/0.2 - 2.5 mm²/24 - 14
IP20/II
> 500000 h
-25°C ... 70°C (> 55° C derating)

3 kV AC (routine test)/4 kV AC (type test)
Conformance with EMC Directive 2004/108/EC
IEC 60950-1/VDE 0805 (SELV)
EN 50178/VDE 0160 (PELV)
DIN VDE 0100-410
UL/C-UL listed UL 508, UL/C-UL Recognized UL 60950

EN 61000-3-2

Technical data

2x 400 V AC ... 500 V AC
264 V AC ... 575 V AC
45 Hz ... 65 Hz
0.6 A (400 V AC)/0.5 A (500 V AC)
< 30 A/< 0.5 A²s
> 65 ms (400 V AC)/> 100 ms (500 V AC)

24 V DC ±1%
3.75 A/3.38 A
Yes, with redundancy module/Yes
< 0.7 W/< 12 W
> 89.5%
< 50 mV_{pp}

LED

0.32 kg/55 x 90 x 84 mm
Alignable: 0 mm horizontally, 30 mm vertically
Screw connection
0.2 - 2.5 mm²/0.2 - 2.5 mm²/24 - 14
IP20/II
> 500000 h
-25°C ... 70°C (> 55° C derating)

3 kV AC (routine test)/4 kV AC (type test)
Conformance with EMC Directive 2004/108/EC
IEC 60950-1/VDE 0805 (SELV)
EN 50178/VDE 0160 (PELV)
DIN VDE 0100-410
UL/C-UL listed UL 508, UL/C-UL Recognized UL 60950,
NEC Class 2 as per UL 1310
EN 61000-3-2

Ordering data

| Type | Order No. | Pcs. / Pkt. |
|----------------------|-----------|-------------|
| UNO-PS/1AC/48DC/ 60W | 2902995 | 1 |

Ordering data

| Type | Order No. | Pcs. / Pkt. |
|----------------------|-----------|-------------|
| UNO-PS/1AC/48DC/100W | 2902996 | 1 |

Ordering data

| Type | Order No. | Pcs. / Pkt. |
|---------------------------|-----------|-------------|
| UNO-PS/2AC/24DC/90W/C2LPS | 2904371 | 1 |

Mounting set

- Used for mounting power storage devices that cannot be mounted on DIN rails
- Suitable for wall and surface mounting



®

| Ordering data | | | |
|---------------------|------------------------------|----------------|-------------|
| Description | Type | Order No. | Pcs. / Pkt. |
| Mounting set | BATTERY MOUNTING CASE | 2320458 | 1 |

Accessories for device circuit breakers

Base element

- For accommodating CB TM.../CB E... device circuit breakers
- PCB module
- Codable

Bridge plug

- Signal contact bridging
- For equipping reserve spaces



Base element for the PCB



Plug for bridging contacts 11 to 14

Total width 12.3 mm

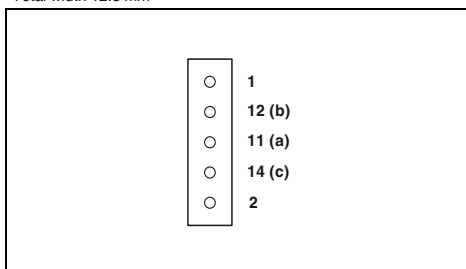

Technical data

Total width 12.3 mm

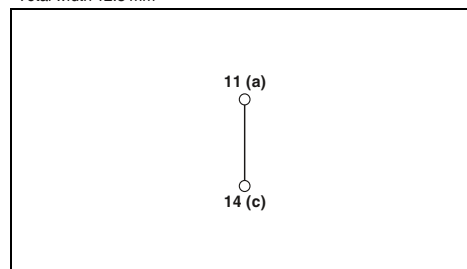

Technical data

| | |
|--|--------------------------------|
| Electrical data - bridge plug | |
| Auxiliary contacts | |
| | Operating voltage U_{max} - |
| | Operating current I_{max} - |
| Electrical data - base element | |
| Rated surge voltage 2.5 kV | |
| Rated insulation voltage U_i 80 V DC | |
| Main circuit | |
| | Rated voltage 80 V DC/277 V AC |
| | Rated current I_n 16 A |
| Remote indication circuit | |
| | Rated voltage 80 V DC/277 V AC |
| | Rated current I_n 1 A |
| General data | |
| Dimensions W/H/D 12.3 mm/34.8 mm/36.4 mm | |
| Ambient temperature (operation) -30°C ... 60°C | |
| Degree of protection in acc. with IEC 60529/EN 60529 IP30 (plug-in area with plugged-in device)/IP00 (connection area) | |
| Inflammability class in acc. with UL 94 V0 | |
| Connection method Solder connection | |
| Test standards DIN EN 50155/IEC 60068-2 | |

| | |
|---|--------------------------------|
| Technical data | |
| Operating voltage U_{max} 277 V AC/80 V DC | |
| Operating current I_{max} 1 A | |
| Rated surge voltage 2.5 kV | |
| Rated insulation voltage U_i 80 V DC | |
| Main circuit | |
| | Rated voltage 80 V DC/277 V AC |
| | Rated current I_n 16 A |
| Remote indication circuit | |
| | Rated voltage 80 V DC/277 V AC |
| | Rated current I_n 1 A |
| General data | |
| Dimensions W/H/D 12.3 mm/45 mm/52 mm | |
| Ambient temperature (operation) -30°C ... 60°C | |
| Degree of protection in acc. with IEC 60529/EN 60529 IP30 (actuation area)/IP00 (connection area) | |
| Inflammability class in acc. with UL 94 V0 | |
| Connection method Spade connection | |
| Test standards IEC 60068-2 | |

| | |
|---|--|
| Description | |
| Soldering base element , for accommodating device circuit breakers | |
| Bridge plug , for bridging contacts 11 to 14 for CB base elements | |

| Ordering data | | |
|---------------|-----------|-------------|
| Type | Order No. | Pcs. / Pkt. |
| CB S-BE | 2905067 | 30 |

| Ordering data | | |
|---------------|-----------|-------------|
| Type | Order No. | Pcs. / Pkt. |
| CB RC BRIDGE | 2801616 | 1 |



Highly compact signal conditioners - MINI Analog Pro
- 3-way signal conditioners
Page 326



Highly compact signal conditioners - MINI Analog Pro
- Temperature transducers for resistance thermometers and thermocouples
Page 330



Highly compact signal conditioners - MINI Analog Pro
- Potipotentiometers
Page 334



Highly compact signal conditioners - MINI Analog Pro
- Supply components, fault monitoring module, marking material
Page 336



Signal conditioners with PL d and SIL functional safety - MACX Safety
- Repeater power supply
Page 342
- Temperature transducers
Page 343



Signal conditioners with PL d and SIL functional safety - MACX Safety
- Repeater power supplies, Ex i
Page 344
- Temperature transducers, Ex i
Page 346



Energy and power measuring technology
- Software for usage data acquisition
Page 348
- Software for data logging
Page 349



Energy and power measuring technology
- Pressure sensor with IO-Link
Page 350



Current and voltage measuring technology
- PACT RCP... current transformers for retrofitting
Page 353



Programmable logic relay system - PLC logic
- Logic modules
Page 356
- Accessories
Page 358



Relay modules - RIFLINE complete
- Fully mounted RIF-0 relay modules with solid-state relay and push-in connection
Page 362



Relay modules - RIFLINE complete
- Fully mounted RIF-1 relay modules with relay with detectable manual operation, status LED, and push-in connection
Page 364

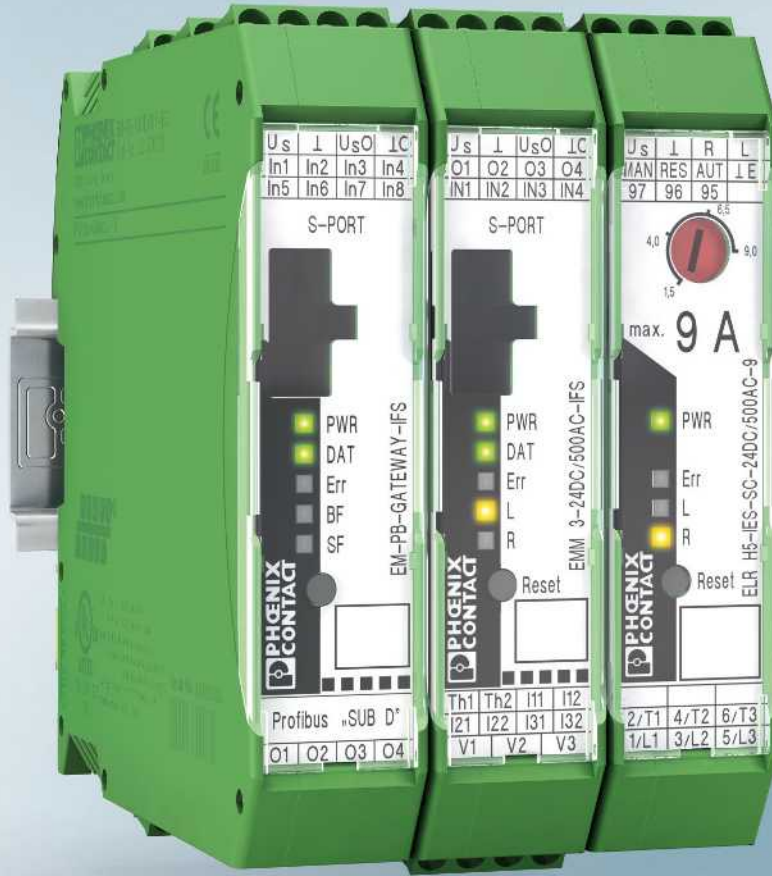

Relay modules - PLC series
- With integrated solid-state relay

Page 366



VARIOFACE system cabling
- VIP power cabling
Universal front adapters for
SIMATIC® S7-300

Page 368

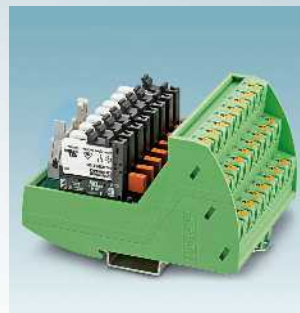

VARIOFACE system cabling
- VIP I/O modules

Page 370
- VIP interface module for Emerson DeltaV
Page 372



VARIOFACE wiring interface
- VIP potential distributor with fuses

Page 373



Easier than ever but slim as before

The new highly compact MINI Analog Pro signal conditioners offer the easiest installation and startup in a confined space.

Easily accessible terminal points, current measurement during operation, and the unique FASTCON Pro plug-in connection technology make your work considerably easier.

Choose the right MINI Analog signal conditioner for your application:

Analog IN/OUT

- Universal and standard 3-way signal conditioners
- 3-way repeater power supplies

Temperature

- Universal measuring transducers for resistance thermometers and thermocouples

Universal potiposition transducer

- Potiposition transducers with automatic potentiometer detection

Accessories

- Supply components
- Fault monitoring module
- Marking material
- Surge protection, see Catalog 6

Easy installation in a confined space

- Thanks to the front orientation, all terminal points are easily visible and accessible at all times – this not only saves time, but also space above and below devices
- All conductors can be fed individually and in any order, regardless of whether you start wiring from the input or output side
- The FASTCON Pro connection terminal blocks can be inserted and removed in any order

Measure current signals during operation

You can conveniently measure signals for startup and servicing during operation, thanks to integrated test disconnect terminal blocks:

- The circuit does not have to be separated in order to integrate the measuring device in the signal circuit
- By setting the plug to the disconnect position, signal circuits can be easily interrupted during servicing and startup

Numerous parameterization options

Easy DIP switch configuration

Many of the MINI Analog modules can be configured: the basic functions can be easily set using DIP switches – without the need for any software.

PC configuration for extended function and monitoring

For extended functionality, you can configure the modules conveniently with the S port interface on your PC using one of the free software solutions.

Smart configuration without accessories

Place your smartphone on the device and establish a wireless connection via near field communication (NFC). Depending on the device type, the free MINI Analog Pro app offers different functions.

App functions via NFC communication



Access to information
– Access module information



DIP switch setting help
– Access module information
– Display DIP switch setting help on the smartphone



Configuration via NFC
– Access module information
– Display DIP switch setting help
– Wireless configuration via smartphone

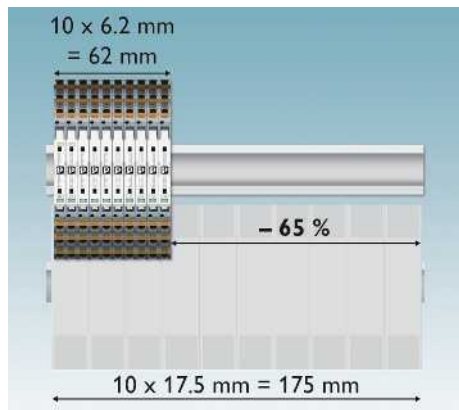

Space savings of up to 65%

- Compared to other signal conditioners on the market with design widths up to 17.5 mm.



Easy installation

- Easily visible and accessible terminal points and FASTCON Pro plug-in connection terminal blocks.



Power bridging and fault monitoring

- The DIN rail connector simplifies supply and enables group error monitoring via remote diagnostics.



Easy to start up and control

- Measure current signals during operation, without disconnecting current loops, plus optional disconnect function.



Numerous parameterization options

- Easy configuration via DIP switches as well as extended configuration via software or smartphone app without additional accessories.

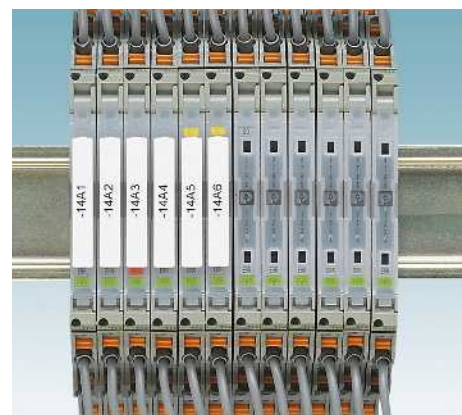

Easy maintenance

- Large-surface marking areas for complete loop identification using standard marking material as well as constantly visible status LEDs in every module.



Choice of connection technology

- Wiring with screw connection or fast and tool-free push-in technology.



Optimum signal quality

- The latest transmission technology and safe electrical isolation between input, output, and supply with 3 kV test voltage.

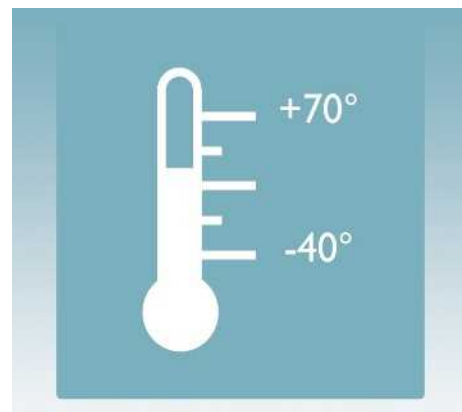

Suitable for any application

- Extended supply voltage and temperature range as well as multifunctional device types.

Analog IN / Analog OUT 3-way signal conditioner

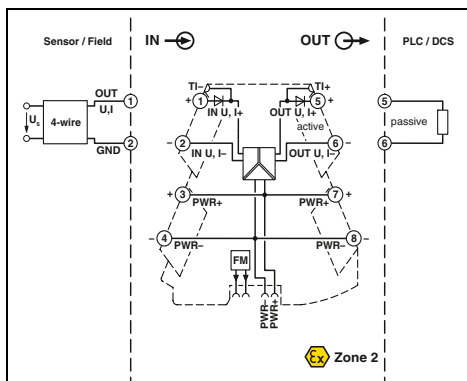

Ex n



**Configurable,
Up to 144 signal combinations**



Housing width 6.2 mm

Technical data

- Configurable, ultra-compact signal conditioner for electrical isolation, conversion, amplification, and filtering of standard analog signals
- Plug-in connection system
- Safe 3-way isolation
- Standard signal combinations configurable via DIP switches
- Power supply and fault monitoring possible via DIN rail connector
- Status LED

| Input data | U input | I input |
|---------------------------------------|---|---|
| Input signal | 0 V ... 5 V 1 V ... 5 V -5 V ... 5 V 0 V ... 10 V 2 V ... 10 V -10 V ... 10 V 0 V ... 20 V 4 V ... 20 V -20 V ... 20 V 0 V ... 24 V 4.8 V ... 24 V -24 V ... 24 V 0 V ... 30 V 6 V ... 30 V -30 V ... 30 V > 1000 kΩ | 0 mA ... 20 mA 4 mA ... 20 mA -20 mA ... 20 mA |
| Input resistance | | approx. 63 Ω |
| Output data | U output | I output |
| Output signal | 0 V ... 5 V 1 V ... 5 V -5 V ... 5 V 0 V ... 10 V 2 V ... 10 V -10 V ... 10 V | 0 mA ... 20 mA 4 mA ... 20 mA |
| Maximum output signal | | 22 mA |
| No-load voltage | | < 17 V |
| Short-circuit current | < 32 mA | |
| Load R_B | ≥ 10 kΩ | ≤ 600 Ω (at 20 mA) |
| Ripple | < 20 mV _{pp} (at 600 Ω) | < 20 mV _{pp} (at 600 Ω) |
| General data | U output | I output |
| Supply voltage U_B | 9.6 V DC ... 30 V DC | |
| Nominal supply voltage | 24 V DC | |
| Current consumption | 25 mA (current output, at 24 V DC incl. load) | 54 mA (current output, at 12 V DC incl. load) ≤ 800 mW (at $I_{OUT} = 20$ mA, 9.6 V DC, 600 Ω load) |
| Power consumption | | |
| Maximum transmission error | $\leq 0.1\%$ (of final value) | |
| Temperature coefficient | 0.01%/K | |
| Limit frequency (3 dB) | 30 Hz (via DIP switch) | |
| Step response (10-90%) | < 8.5 ms (with 30 Hz filter) | |
| Electrical isolation | Reinforced insulation in accordance with IEC 61010-1 | |
| Test voltage, input/output/supply | 3 kV (50 Hz, 1 min.) | |
| Degree of protection | IP20 | |
| Ambient temperature (operation) | -40°C ... 70°C | |
| Mounting | Any | |
| Housing material | PBT | |
| Dimensions W/H/D | 6.2/110.5/120.5 mm | |
| Push-in connection solid/stranded/AWG | 0.2 ... 2.5 mm ² /0.2 ... 2.5 mm ² /26 - 12 | |
| Screw connection solid/stranded/AWG | 0.2 ... 1.5 mm ² /0.2 ... 1.5 mm ² /26 - 16 | |
| EMC note | Class A product, see page 443 | |
| Conformance / approvals | CE-compliant | |
| Conformance | II 3 G Ex nA IIC T4 Gc X | |
| ATEX | 508 listing applied for Class I, Div. 2, Groups A, B, C, D T5 applied for | |
| UL, USA / Canada | GL applied for | |
| GL | | |

Ordering data

| Description | Type | Order No. | Pcs. / Pkt. | |
|--|--------------------|------------------------------|-------------|---|
| 3-way signal conditioner , for electrical isolation of analog signals | | | | |
| Standard configuration | Push-in connection | MINI MCR-2-UI-UI-PT | 2902040 | 1 |
| Standard configuration | Screw connection | MINI MCR-2-UI-UI | 2902037 | 1 |
| Order configuration | Push-in connection | MINI MCR-2-UI-UI-PT-C | 2902039 | 1 |
| Order configuration | Screw connection | MINI MCR-2-UI-UI-C | 2902036 | 1 |

Measurement and control technology - MINI Analog Pro highly compact signal conditioners

Order key for MINI-MCR-2-UI-UI...C 3-way signal conditioner (standard configuration entered as an example)

Order No. Input Output Cut-off frequency

| 2902036 | IN03 | OUT01 | 5K |
|--|---|--|----------------|
| 2902036 ≙ MINI-MCR-2- UI-UI-C | IN 01 ≙ 0...20 mA IN 02 ≙ 4...20 mA IN 03 ≙ 0...10 V IN 04 ≙ 2...10 V | OUT 01 ≙ 0...20 mA OUT 02 ≙ 4...20 mA OUT 03 ≙ 0...10 V OUT 04 ≙ 2...10 V | 30 Hz 5 kHz |
| 2902039 ≙ MINI-MCR-2- UI-UI-PT-C | IN 05 ≙ 0...5 V IN 06 ≙ 1...5 V IN 21 ≙ -5...5 V IN 22 ≙ -10...10 V IN 23 ≙ -20...20 V IN 32 ≙ 0...20 V IN 35 ≙ -20...20 mA IN 38 ≙ 0...24 V IN 39 ≙ 0...30 V IN 80 ≙ -30...30 V IN 93 ≙ -24...24 V IN 94 ≙ 4.8...24 V IN 95 ≙ 6...30 V IN 96 ≙ 4...20 V | OUT 05 ≙ 0...5 V OUT 06 ≙ 1...5 V OUT 13 ≙ -5...5 V OUT 14 ≙ -10...10 V | |

Signal combinations for MINI-MCR-2-UI-UI... signal conditioners

| Input | Output | | | | | | | |
|-------------|-----------|-----------|---------|---------|----------|----------|----------|------------|
| | 0...20 mA | 4...20 mA | 0...5 V | 1...5 V | -5...5 V | 0...10 V | 2...10 V | -10...10 V |
| 0...20 mA | X | X | X | X | X | X | X | X |
| 4...20 mA | X | X | X | X | X | X | X | X |
| -20...20 mA | X | X | X | X | X | X | X | X |
| 0...5 V | X | X | X | X | X | X | X | X |
| 1...5 V | X | X | X | X | X | X | X | X |
| -5...5 V | X | X | X | X | X | X | X | X |
| 0...10 V | X | X | X | X | X | X | X | X |
| 2...10 V | X | X | X | X | X | X | X | X |
| -10...10 V | X | X | X | X | X | X | X | X |
| 0...20 V | X | X | X | X | X | X | X | X |
| 4...20 V | X | X | X | X | X | X | X | X |
| -20...20 V | X | X | X | X | X | X | X | X |
| 0...24 V | X | X | X | X | X | X | X | X |
| 4.8...24 V | X | X | X | X | X | X | X | X |
| -24...24 V | X | X | X | X | X | X | X | X |
| 0...30 V | X | X | X | X | X | X | X | X |
| 6...30 V | X | X | X | X | X | X | X | X |
| -30...30 V | X | X | X | X | X | X | X | X |

Analog IN / Analog OUT
3-way signal conditioner

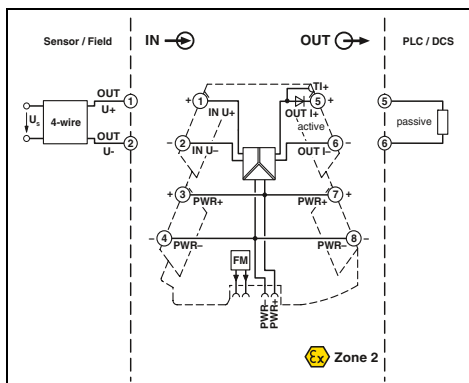

Ex n



With fixed signal combinations

- Highly compact signal conditioner for electrical isolation, conversion, amplification, and filtering of standard analog signals
- Fixed signal combinations
- Plug-in connection system
- Safe 3-way isolation
- Power supply and fault monitoring possible via DIN rail connector
- Status LED

| | | |
|---------------------------------------|---|----------------------------------|
| Input data | U input | I input |
| Input resistance | approx. 100 kΩ | approx. 63 Ω |
| Output data | U output | I output |
| Maximum output signal | 11 V | 22 mA |
| No-load voltage | | < 17 V |
| Short-circuit current | < 15 mA | |
| Load R _B | ≥ 10 kΩ | ≤ 600 Ω (at 20 mA) |
| Ripple | < 20 mV _{pp} (at 10 kΩ) | < 20 mV _{pp} (at 600 Ω) |
| General data | 9.6 V DC ... 30 V DC | |
| Supply voltage U _B | 24 V DC | |
| Nominal supply voltage | 25 mA (at 24 V DC) | |
| Typ. current consumption | 0.1% (of final value) | |
| Maximum transmission error | 0.01%/K | |
| Temperature coefficient | approx. 30 Hz | |
| Limit frequency (3 dB) | approx. 10 ms | |
| Step response (10-90%) | IP20 | |
| Degree of protection | Reinforced insulation in accordance with IEC 61010-1 | |
| Electrical isolation | 3 kV (50 Hz, 1 min.) | |
| Test voltage, input/output/supply | -40°C ... 70°C | |
| Ambient temperature (operation) | PBT | |
| Housing material | 6.2/110.5/120.5 mm | |
| Dimensions W/H/D | 0.2 ... 2.5 mm ² /0.2 ... 2.5 mm ² /26 - 12 | |
| Push-in connection solid/stranded/AWG | 0.2 ... 1.5 mm ² /0.2 ... 1.5 mm ² /26 - 16 | |
| Screw connection solid/stranded/AWG | Class A product, see page 443 | |
| EMC note | CE-compliant | |
| Conformance / approvals | Ex II 3 G Ex nA IIC T4 Gc X | |
| Conformance | 508 listing applied for | |
| ATEX | Class I, Div. 2, Groups A, B, C, D T5 applied for | |
| UL, USA / Canada | GL applied for | |
| GL | | |

| Technical data | | |
|---|----------------------------------|--|
| U input | I input | |
| approx. 100 kΩ | approx. 63 Ω | |
| U output | I output | |
| 11 V | 22 mA | |
| | < 17 V | |
| < 15 mA | | |
| ≥ 10 kΩ | ≤ 600 Ω (at 20 mA) | |
| < 20 mV _{pp} (at 10 kΩ) | < 20 mV _{pp} (at 600 Ω) | |
| 9.6 V DC ... 30 V DC | | |
| 24 V DC | | |
| 25 mA (at 24 V DC) | | |
| 0.1% (of final value) | | |
| 0.01%/K | | |
| approx. 30 Hz | | |
| approx. 10 ms | | |
| IP20 | | |
| Reinforced insulation in accordance with IEC 61010-1 | | |
| 3 kV (50 Hz, 1 min.) | | |
| -40°C ... 70°C | | |
| PBT | | |
| 6.2/110.5/120.5 mm | | |
| 0.2 ... 2.5 mm ² /0.2 ... 2.5 mm ² /26 - 12 | | |
| 0.2 ... 1.5 mm ² /0.2 ... 1.5 mm ² /26 - 16 | | |
| Class A product, see page 443 | | |
| CE-compliant | | |
| Ex II 3 G Ex nA IIC T4 Gc X | | |
| 508 listing applied for | | |
| Class I, Div. 2, Groups A, B, C, D T5 applied for | | |
| GL applied for | | |

| Description | Input signal | Output signal |
|---|--------------------------|--------------------------|
| 3-way signal conditioner, for electrical isolation of analog signals | | |
| Push-in connection | 0 ... 10 V | 0 ... 20 mA |
| Screw connection | 0 ... 10 V | 0 ... 20 mA |
| Push-in connection | 0 ... 10 V | 4 ... 20 mA |
| Screw connection | 0 ... 10 V | 4 ... 20 mA |
| Push-in connection | 0 ... 20 mA | 0 ... 10 V |
| Screw connection | 0 ... 20 mA | 0 ... 10 V |
| Push-in connection | 4 ... 20 mA | 0 ... 10 V |
| Screw connection | 4 ... 20 mA | 0 ... 10 V |
| Push-in connection | 0 ... 20 mA, 4 ... 20 mA | 0 ... 20 mA, 4 ... 20 mA |
| Screw connection | 0 ... 20 mA, 4 ... 20 mA | 0 ... 20 mA, 4 ... 20 mA |
| Push-in connection | 0 ... 10 V, -10 ... 10 V | 0 ... 10 V, -10 ... 10 V |
| Screw connection | 0 ... 10 V, -10 ... 10 V | 0 ... 10 V, -10 ... 10 V |

| Ordering data | | |
|--------------------|-----------|-------------|
| Type | Order No. | Pcs. / Pkt. |
| MINI MCR-2-U-I0-PT | 2902023 | 1 |
| MINI MCR-2-U-I0 | 2902022 | 1 |
| MINI MCR-2-U-I4-PT | 2902030 | 1 |
| MINI MCR-2-U-I4 | 2902029 | 1 |
| MINI MCR-2-I0-U-PT | 2902001 | 1 |
| MINI MCR-2-I0-U | 2902000 | 1 |
| MINI MCR-2-I4-U-PT | 2902003 | 1 |
| MINI MCR-2-I4-U | 2902002 | 1 |
| MINI MCR-2-I-I-PT | 2901999 | 1 |
| MINI MCR-2-I-I | 2901998 | 1 |
| MINI MCR-2-U-U-PT | 2902043 | 1 |
| MINI MCR-2-U-U | 2902042 | 1 |

Analog IN / Analog OUT
repeater power supplies

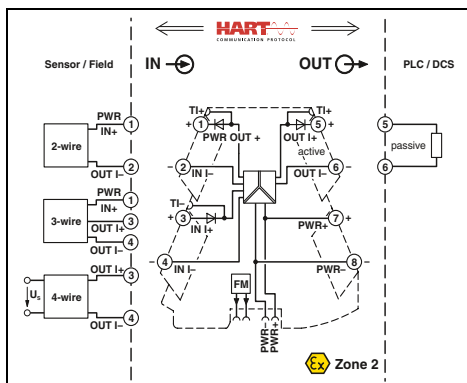
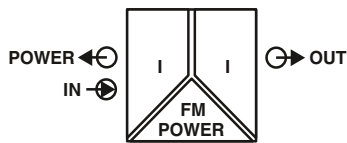

Repeater power supply with HART transmission

Housing width 6.2 mm

Technical data

Input data

Input signal
Input resistance
Transmitter supply voltage

Output data

Output signal
Maximum output signal
No-load voltage
Load R_B
Ripple

General data

Supply voltage U_B
Nominal supply voltage
Current consumption
Power consumption

Maximum transmission error
Temperature coefficient
Limit frequency (3 dB)
Communication

Step response (10-90%)

Electrical isolation
Test voltage, input/output/supply
Degree of protection

Ambient temperature (operation)
Mounting
Housing material
Dimensions W/H/D
Push-in connection solid/stranded/AWG
Screw connection solid/stranded/AWG
EMC note

Conformance / approvals

Conformance
ATEX
UL, USA / Canada

GL

0 ... 20 mA, isolator operation/4 ... 20 mA
approx. 68 Ω
> 19.5 V

0 ... 20 mA/4 ... 20 mA

< 20 V
 $\leq 600 \Omega$ (at 20 mA)
< 20 mV_{PP} (at 600 Ω)

9.6 V DC ... 30 V DC
24 V DC
25 mA (at 24 V DC and in isolator operation)
 ≤ 1400 mW (at $I_{OUT} = 20$ mA, 9.6 V DC, 600 Ω load)

0.1% (of final value)
0.01%/K,
> 1.75 kHz (typ.)
HART specification in both operating modes
(RPSS isolator/RPSS repeater power supply)
< 200 μ s (typ.)
Reinforced insulation in accordance with IEC 61010-1

IP20
-40°C ... 70°C
Any
PBT
6.2/110.5/120.5 mm
0.2 ... 2.5 mm²/0.2 ... 2.5 mm²/26 - 12
0.2 ... 1.5 mm²/0.2 ... 1.5 mm²/26 - 16
Class A product, see page 443

CE-compliant
II 3 G Ex nA IIC T4 Gc X
508 listing applied for
Class I, Div. 2, Groups A, B, C, D T5 applied for
GL applied for

Ordering data

| Description | Ordering data | | | |
|--|--------------------|------------------------|-------------|---|
| | Type | Order No. | Pcs. / Pkt. | |
| Repeater power supply with HART transmission | Push-in connection | MINI MCR-2-RPSS-I-I-PT | 2902015 | 1 |
| | Screw connection | MINI MCR-2-RPSS-I-I | 2902014 | 1 |

- Highly-compact repeater power supply for electrical isolation, conversion, amplification, and filtering of standard analog signals
- Supply of 2-wire and passive 3-wire sensors
- Can also be used as an isolator without supply
- Plug-in connection system
- Safe 3-way isolation
- Bidirectional HART transmission as an option
- Power supply and fault monitoring possible via DIN rail connector
- Status LED

Temperature

Temperature transducers for resistance thermometers

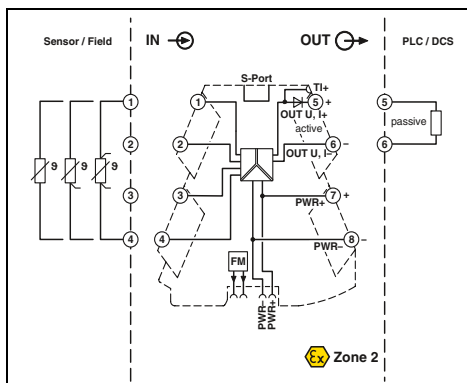

Ex n



Universal measuring transducer for resistance thermometers

Ex: Ex

Housing width 6.2 mm

Technical data

- Universally configurable, highly compact temperature transducer for electrical isolation, conversion, amplification, and filtering of resistance thermometer and remote resistance-type sensor signals
- For 2, 3 or 4-wire sensors according to IEC 751, JIS, GOST

- Plug-in connection system
- Safe 3-way isolation
- Standard signal combinations configurable via DIP switches
- Freely configurable via software or smartphone app
- Power supply and fault monitoring possible via DIN rail connector
- Status and error indicator LEDs

| | |
|--------------------------------|--|
| Input data | Input signal (can be configured using DIP switches) Temperature range |
| Measuring range span | Linear resistance measuring range |
| Output data | Output signal |
| Maximum output signal | Load R_B Ripple |
| General data | Supply voltage U_B Current consumption Power consumption |
| Transmission error | |
| Temperature coefficient | Step response (0–99%) |
| Electrical isolation | Test voltage, input/output/supply Ambient temperature (operation) Housing material Dimensions W/H/D Push-in connection solid/stranded/AWG Screw connection solid/stranded/AWG EMC note |
| Conformance / approvals | Conformance ATEX UL, USA / Canada GL |

| | |
|--|---|
| Pt, Ni, Cu sensors : 2, 3, 4-wire -200°C ... 850°C (range depending on the sensor type) | |
| ≥ 20 K 0 Ω ... 4000 Ω (Minimum measuring span: 10% of the selected measuring range) | |
| U output 0 ... 5 V/1 ... 5 V 0 ... 10 V/10 ... 0 V approx. 12.3 V ≥ 10 kΩ < 20 mV _{pp} | I output 0 ... 20 mA/4 ... 20 mA 20 ... 0 mA/20 ... 4 mA 24.6 mA ≤ 600 Ω (at 20 mA) < 20 mV _{pp} (at 600 Ω) |
| 9.6 V DC ... 30 V DC 32 mA (at 24 V DC) ≤ 850 mW (at $I_{OUT} = 20$ mA, 9.6 V DC, 600 Ω load) | |
| 0.1% * 350 K/set measuring range; 0.1% > 350 K (Pt/Ni) 0.3% * 200 K/set measuring range; 0.3% > 200 K (Cu) | |
| 0.01%/K Typ. 200 ms (2-wire) Typ. 500 ms (3-wire) Typ. 500 ms (4-wire) | |
| Reinforced insulation in accordance with IEC 61010-1 3 kV (50 Hz, 1 min.) -40°C ... 70°C PBT 6.2/110.5/120.5 mm 0.2 ... 2.5 mm ² /0.2 ... 2.5 mm ² /26 - 12 0.2 ... 1.5 mm ² /0.2 ... 1.5 mm ² /26 - 16 Class A product, see page 443 | |
| CE-compliant Ex II 3 G Ex nA IIC T4 Gc X 508 listing applied for Class I, Div. 2, Groups A, B, C, D T5 applied for GL applied for | |

Ordering data

| | |
|--|--------------------|
| Description | |
| Temperature transducers for resistance thermometers | |
| Standard configuration | Push-in connection |
| Standard configuration | Screw connection |
| Order configuration | Push-in connection |
| Order configuration | Screw connection |

| Type | Order No. | Pcs. / Pkt. |
|------------------------|-----------|-------------|
| MINI MCR-2-RTD-UI-PT | 2902052 | 1 |
| MINI MCR-2-RTD-UI | 2902049 | 1 |
| MINI MCR-2-RTD-UI-PT-C | 2902051 | 1 |
| MINI MCR-2-RTD-UI-C | 2902048 | 1 |

Accessories

| |
|--|
| Programming adapter for configuring modules with S-PORT interface |
|--|

| | | |
|----------------------|---------|---|
| IFS-USB-PROG-ADAPTER | 2811271 | 1 |
|----------------------|---------|---|

Measurement and control technology - MINI Analog Pro highly compact signal conditioners

Order key for MINI-MCR-2-RTD-UI...C temperature transducer (standard configuration entered as an example)

| Order No. | Sensor type | Connection technology | Measuring range | | Measuring unit | Output | | |
|----------------------------------|---|--|---|---|------------------|----------------|---|---|
| | | | Start | End | | Output signal | Start | End |
| 2902048 | PT100 | 3 | -50 | 150 | C | I | 4.0 | 20.0 |
| 2902048 ≙ MINI-MCR-2-RTD-UI-C | PT100 ≙ Pt 100 IEC 751 PT200 ≙ Pt 200 IEC 751 PT500 ≙ Pt 500 IEC 751 PT1000 ≙ Pt 1000 IEC 751 PT100G ≙ Pt 100 GOST 6651-2009 (α = 0.00394) PT1000G ≙ Pt 1000 GOST 6651-2009 (α = 0.00394) PT100J ≙ Pt 100 JIS C1604/1997 PT1000J ≙ Pt 1000 JIS C1604/1997 Ni100 ≙ Ni 100 DIN 43760 Ni1000 ≙ Ni 1000 DIN 43760 Cu50 ≙ Cu 50 GOST 6651-2009 (α = 0.00428) Cu100 ≙ Cu 100 GOST 6651-2009 (α = 0.00428) Cu53 ≙ Cu 53 GOST 6651-2009 (α = 0.00426) | 2 ≙ 2-wire 3 ≙ 3-wire 4 ≙ 4-wire | freely selectable between -200°C...850°C (measuring range limits depend on sensor type) | freely selectable between -200°C...850°C (measuring range limits depend on sensor type) | C ≙ °C F ≙ °F | I ≙ I U ≙ U | 0.0 ≙ 0 mA I: freely selectable between 0.0...21 mA U: freely selectable between 0.0...10.5 V | 20.0 ≙ 20 mA I: freely selectable between 0.0...21 mA U: freely selectable between 0.0...10.5 V |

Failure information

Behavior in the event of an error

Open circuit

Short circuit

Overrange

Underrange

| ... | NE43DO | 0.0 | 0.0 | 0.0 | 0.0 |
|--|---|---|---|---|---|
| FD ≙ Freely definable | 0.0 ≙ 0 mA I: freely selectable between 0.0...21.5 mA U: freely selectable between 0.0...11 V (signal type corresponds to selected output signal) | 0.0 ≙ 0 mA I: freely selectable between 0.0...21.5 mA U: freely selectable between 0.0...11 V (signal type corresponds to selected output signal) | 0.0 ≙ 0 mA I: freely selectable between 0.0...21.5 mA U: freely selectable between 0.0...11 V (signal type corresponds to selected output signal) | 0.0 ≙ 0 mA I: freely selectable between 0.0...21.5 mA U: freely selectable between 0.0...11 V (signal type corresponds to selected output signal) | 0.0 ≙ 0 mA I: freely selectable between 0.0...21.5 mA U: freely selectable between 0.0...11 V (signal type corresponds to selected output signal) |
| Note: failure information according to NE 43 can only be selected for 4...20 mA output | | | | | |
| NE43UP ≙ NE 43 upscale NE43DO ≙ NE 43 downscale NE430 ≙ NE 43 0 mA NE43UD ≙ NE 43 upscale/downscale | 21.5 mA 3.5 mA 0 mA 3.5 mA | 21.5 mA 3.5 mA 0 mA 3.5 mA | 21.5 mA 3.5 mA 0 mA 3.5 mA | 21.5 mA 3.5 mA 0 mA 21.5 mA | 21.5 mA 3.5 mA 0 mA 21.5 mA |

Sensor types and measuring ranges for MINI-MCR-2-RTD-UI... temperature transducers

| Sensor type | Standard | Measuring range | Smallest measuring span | Adjustable using: |
|---|--|-------------------|-------------------------|----------------------------|
| Pt100 | IEC 751 = GOST 6651-2009 (α = 0.00385) | -200°C ... +850°C | 20 K | DIP switch |
| Pt200 | IEC 751 = GOST 6651-2009 (α = 0.00385) | -200°C ... +850°C | 20 K | DIP switch |
| Pt500 | IEC 751 = GOST 6651-2009 (α = 0.00385) | -200°C ... +850°C | 20 K | Software or smartphone app |
| Pt1000 | IEC 751 = GOST 6651-2009 (α = 0.00385) | -200°C ... +850°C | 20 K | Software or smartphone app |
| Pt100 | GOST 6651-2009 (α = 0.00391) | -200°C ... +850°C | 20 K | Software or smartphone app |
| Pt1000 | GOST 6651-2009 (α = 0.00391) | -200°C ... +850°C | 20 K | Software or smartphone app |
| Pt100 | JIS C1604-1997 | -200°C ... +850°C | 20 K | Software or smartphone app |
| Pt1000 | JIS C1604-1997 | -200°C ... +850°C | 20 K | Software or smartphone app |
| Ni100 | DIN 43760 | -60°C ... +250°C | 20 K | Software or smartphone app |
| Ni1000 | DIN 43760 | -60°C ... +250°C | 20 K | Software or smartphone app |
| Cu50 | GOST 6651-2009 (α = 0.0428) | -180°C ... +200°C | 20 K | Software or smartphone app |
| Cu100 | GOST 6651-2009 (α = 0.0428) | -180°C ... +200°C | 20 K | Software or smartphone app |
| Cu53 | GOST 6651-2009 (α = 0.0426) | -50°C ... +180°C | 20 K | Software or smartphone app |
| Customer-specific characteristic curves | | -200°C ... +850°C | 20 K | Software or smartphone app |

Temperature

Temperature transducers for thermocouples

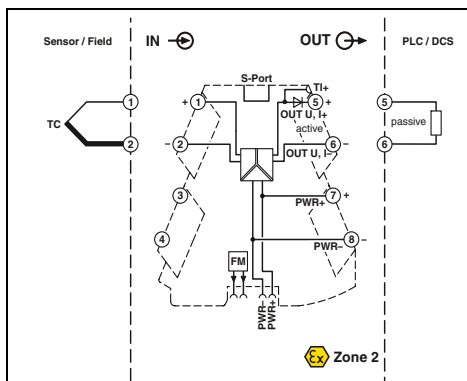
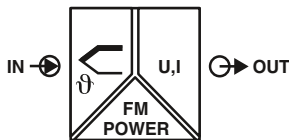

Universal measuring transducer for thermocouples

Ex: Ex

Housing width 6.2 mm

- Universally configurable, highly compact temperature transducer for electrical isolation, conversion, amplification, and filtering of thermocouple signals
- For thermocouples according to IEC 584 and GOST
- Internal cold junction compensation
- Plug-in connection system
- Safe 3-way isolation
- Standard signal combinations configurable via DIP switches
- Freely configurable via software or smartphone app
- Power supply and fault monitoring possible via DIN rail connector
- Status and error indicator LEDs

| | |
|--------------------------------|--|
| Input data | Input signal (can be configured using DIP switches) Temperature range |
| Measuring range span | |
| Output data | Output signal (configurable using the DIP switch) |
| Maximum output signal | No-load voltage Short-circuit current Load R_B Ripple |
| General data | Supply voltage U_B Current consumption Power consumption |
| Transmission error | |
| Cold junction errors | Temperature coefficient Step response (0-99%) Electrical isolation Test voltage, input/output/supply Ambient temperature (operation) Housing material Dimensions W/H/D Push-in connection solid/stranded/AWG Screw connection solid/stranded/AWG EMC note |
| Conformance / approvals | Conformance ATEX UL, USA / Canada GL |

Technical data

B, E, J, K, N, R, S, T, L, U, A-1, A-2, A-3, M, L
-250°C ... 2500°C (range depending on the sensor type)

| | |
|---------------------------|--|
| min. 50 K | |
| U output | I output |
| 0 ... 5 V/1 ... 5 V | 0 ... 20 mA/4 ... 20 mA |
| 0 ... 10 V/10 ... 0 V | 20 ... 0 mA/20 ... 4 mA |
| approx. 12.3 V | 24.6 mA |
| | < 17.5 V |
| < 31.5 mA | |
| $\geq 10 \text{ k}\Omega$ | $\leq 600 \Omega$ (at 20 mA) |
| < 20 mV _{PP} | < 20 mV _{PP} (at 600 Ω) |

9.6 V DC ... 30 V DC
32 mA (at 24 V DC)
 $\leq 850 \text{ mW}$ (at $I_{OUT} = 20 \text{ mA}$, 9.6 V DC, 600 Ω load)

0.1% * 600 K/set measuring range; 0.1% > 600 K (E, J, K, N, T, L, U, M Gost, L Gost)
0.2% * 600 K/set measuring range; 0.2% > 600 K (B, R, S, A1, A2, A3)
(0.2 K * ΔT) (typ. < 2 K)
 $\leq 0.01\%/K$
Typ. 400 ms
Reinforced insulation in accordance with IEC 61010-1
3 kV (50 Hz, 1 min.)
-40°C ... 70°C
PBT
6.2/110.5/120.5 mm
0.2 ... 2.5 mm²/0.2 ... 2.5 mm²/26 - 12
0.2 ... 1.5 mm²/0.2 ... 1.5 mm²/26 - 16
Class A product, see page 443

CE-compliant
Ex II 3 G Ex nA IIC T4 Gc X
508 listing applied for Class I, Div. 2, Groups A, B, C, D T5 applied for GL applied for

Ordering data

| | |
|--|--------------------|
| Description | |
| Temperature transducers for thermocouples | |
| Standard configuration | Push-in connection |
| Standard configuration | Screw connection |
| Order configuration | Push-in connection |
| Order configuration | Screw connection |

| Type | Order No. | Pcs. / Pkt. |
|-----------------------|-----------|-------------|
| MINI MCR-2-TC-UI-PT | 2905249 | 1 |
| MINI MCR-2-TC-UI | 2902055 | 1 |
| MINI MCR-2-TC-UI-PT-C | 2905248 | 1 |
| MINI MCR-2-TC-UI-C | 2902053 | 1 |

Accessories

| | |
|--|--|
| Programming adapter for configuring modules with S-PORT interface | |
|--|--|

| | | |
|-----------------------------|---------|---|
| IFS-USB-PROG-ADAPTER | 2811271 | 1 |
|-----------------------------|---------|---|

Measurement and control technology - MINI Analog Pro highly compact signal conditioners

Order key for MINI-MCR-2-TC-UI...C temperature transducer (standard configuration entered as an example)

| Order No. | Sensor type | Cold junction compensation | Measuring range Start | End | Measuring unit | Output Output signal | Start | End | ... |
|---------------------------------|---|----------------------------|--|--|------------------|-------------------------|---|---|-----|
| 2902048 | J | 1 | -200 | 1200 | C | I | 4.0 | 20.0 | ... |
| 2902253 ≙ MINI-MCR-2-TC-UI-C | B ≙ B IEC 584-1 (Pt130Rh-Pt6Rh) E ≙ E IEC 584-1 (NiCr-CuNi) J ≙ J IEC 584-1 (Fe-CuNi) K ≙ K IEC 584-1 (NiCr-Ni) N ≙ N IEC 584-1 (NiCrSi-NiSi) R ≙ R IEC 584-1 (Pt13Rh-Pt) S ≙ S IEC 584-1 (Pt10Rh-Pt) T ≙ T IEC 584-1 (Cu-CuNi) L ≙ L DIN 43760 (Fe-CuNi) U ≙ U DIN 43760 (Cu-CuNi) A1G ≙ A-1 GOST 8.585-2001 A2G ≙ A-2 GOST 8.585-2001 A3G ≙ A-3 GOST 8.585-2001 MG ≙ M GOST 8.585-2001 LG ≙ L GOST 8.585-2001 | 0 ≙ OFF 1 ≙ ON | freely selectable between -250°C...2500°C (measuring range limits depend on sensor type) | freely selectable between -250°C...2500°C (measuring range limits depend on sensor type) | C ≙ °C F ≙ °F | I ≙ I U ≙ U | 0.0 ≙ 0 mA I: freely selectable between 0.0...21 mA U: freely selectable between 0.0...10.5 V | 20.0 ≙ 20 mA I: freely selectable between 0.0...21 mA U: freely selectable between 0.0...10.5 V | ... |

Failure information

Behavior in the event of an error

Open circuit

Overrange

Underrange

| ... | NE43DO | 0.0 | 0.0 | 0.0 |
|---|--------|---|---|---|
| FD ≙ Freely definable | | 0.0 ≙ 0 mA I: freely selectable between 0.0...21.5 mA U: freely selectable between 0.0...11 V (signal type corresponds to selected output signal) | 0.0 ≙ 0 mA I: freely selectable between 0.0...21.5 mA U: freely selectable between 0.0...11 V (signal type corresponds to selected output signal) | 0.0 ≙ 0 mA I: freely selectable between 0.0...21.5 mA U: freely selectable between 0.0...11 V (signal type corresponds to selected output signal) |
| Note: failure information according to NE 43 can only be selected for 4...20 mA output | | | | |
| NE43UP ≙ NE 43 upscale | | 21.5 mA | 21.5 mA | 21.5 mA |
| NE43DO ≙ NE 43 downscale | | 3.5 mA | 3.5 mA | 3.5 mA |
| NE430 ≙ NE 43 0 mA | | 0 mA | 0 mA | 0 mA |
| NE43UD ≙ NE 43 upscale/downscale | | 3.5 mA | 21.5 mA | 21.5 mA |

Sensor types and measuring ranges for MINI-MCR-2-TC-UI... temperature transducers

| Sensor type | Standard | Measuring range | Smallest measuring span | Adjustable using: |
|---|------------|--------------------|-------------------------|----------------------------|
| B | IEC 584-1 | +500°C ... +1820°C | 50 K | Software or smartphone app |
| E | IEC 584-1 | -230°C ... +1000°C | 50 K | Software or smartphone app |
| J | IEC 584-1 | -210°C ... +1200°C | 50 K | DIP switch |
| K | IEC 584-1 | -250°C ... +1372°C | 50 K | DIP switch |
| N | IEC 584-1 | -200°C ... +1300°C | 50 K | Software or smartphone app |
| R | IEC 584-1 | -50°C ... +1768°C | 50 K | Software or smartphone app |
| S | IEC 584-1 | -50°C ... +1768°C | 50 K | Software or smartphone app |
| T | IEC 584-1 | -200°C ... +400°C | 50 K | Software or smartphone app |
| L | DIN 43710 | -200°C ... +900°C | 50 K | Software or smartphone app |
| U | DIN 43710 | -200°C ... +600°C | 50 K | Software or smartphone app |
| A-1 | GOST 8.585 | 0°C ... +2500°C | 50 K | Software or smartphone app |
| A-2 | GOST 8.585 | 0°C ... +1800°C | 50 K | Software or smartphone app |
| A-3 | GOST 8.585 | 0°C ... +1800°C | 50 K | Software or smartphone app |
| M | GOST 8.585 | -200°C ... +100°C | 50 K | Software or smartphone app |
| L | GOST 8.585 | -200°C ... +800°C | 50 K | Software or smartphone app |
| Customer-specific characteristic curves | | -250°C ... +2500°C | 50 K | Software or smartphone app |

Potentiometers, potiposition transducers

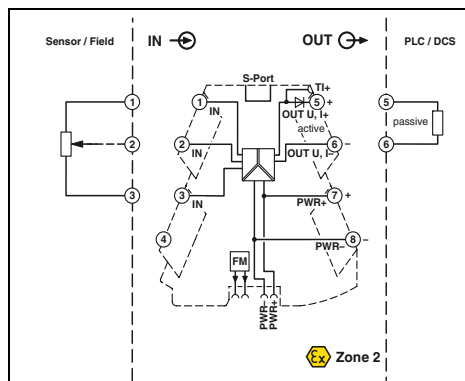
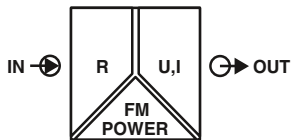

Configurable, automatic potentiometer detection

Ex: Ex

Housing width 6.2 mm

- Universally configurable, highly compact potiposition transducer for electrical isolation, conversion, amplification, and filtering of potentiometer signals
- For potentiometers from 100 Ω to 100 kΩ
- Automatic potentiometer detection without manual adjustment
- Plug-in connection system
- Safe 3-way isolation
- Standard signal combinations configurable via DIP switches
- Freely configurable via software or smartphone app
- Power supply and fault monitoring possible via DIN rail connector
- Status and error indicator LEDs

| | |
|-----------------------------------|--|
| Input data | Potentiometer Reference voltage source |
| Output data | Output signal |
| Maximum output signal | No-load voltage Short-circuit current Load R_B Ripple Behavior in the event of a sensor error |
| General data | Supply voltage U_B Nominal supply voltage Current consumption Power consumption |
| Maximum transmission error | Temperature coefficient Step response (0-99%) Electrical isolation Test voltage, input/output/supply Degree of protection Ambient temperature (operation) Mounting Housing material Dimensions W/H/D Push-in connection solid/stranded/AWG Screw connection solid/stranded/AWG EMC note |
| Conformance / approvals | Conformance ATEX UL, USA / Canada GL |

Technical data

| | |
|---|---|
| 100 Ω ... 100 kΩ | - |
| U output | I output |
| 1 ... 5 V/10 ... 0 V | 0 ... 20 mA/4 ... 20 mA |
| 0 ... 5 V/0 ... 10 V | 20 ... 0 mA/20 ... 4 mA |
| approx. 12.3 V | 24.6 mA |
| < 31.5 mA | < 17.5 V |
| ≥ 10 kΩ | ≤ 600 Ω (at 20 mA) |
| < 20 mV _{PP} (at 10 kΩ) | < 20 mV _{PP} |
| (configurable) | |
| 9,6 V DC ... 30 V DC | 24 V DC |
| 33 mA (at 24 V DC) | ≤ 850 mW (at $I_{OUT} = 20$ mA, 9,6 V DC, 600 Ω load) |
| < 0.1% ($R < 240$ Ω = < 0,2%) | 0.01%/K |
| - | - |
| Reinforced insulation in accordance with IEC 61010-1 | 3 kV (50 Hz, 1 min.) |
| IP20 | -40°C ... 70°C |
| Any | PBT |
| 6,2/110,5/120,5 mm | 0,2 ... 2,5 mm ² /0,2 ... 2,5 mm ² /26 - 12 |
| 0,2 ... 1,5 mm ² /0,2 ... 1,5 mm ² /26 - 18 | Class A product, see page 443 |
| CE-compliant | Ex II 3 G Ex nA IIC T4 Gc X |
| 508 listing applied for Class I, Div. 2, Groups A, B, C, D T5 applied for | GL applied for |

Ordering data

| | |
|--------------------------------|--------------------|
| Description | |
| Potiposition transducer | |
| Standard configuration | Push-in connection |
| Standard configuration | Screw connection |
| Order configuration | Push-in connection |
| Order configuration | Screw connection |

| Type | Order No. | Pcs. / Pkt. |
|-------------------------------|----------------|-------------|
| MINI MCR-2-POT-UI-PT | 2902017 | 1 |
| MINI MCR-2-POT-UI | 2902016 | 1 |
| MINI MCR-2-POT-UI-PT-C | 2905006 | 1 |
| MINI MCR-2-POT-UI-C | 2905005 | 1 |

Accessories

| | |
|--|--|
| Programming adapter for configuring modules with S-PORT interface | |
|--|--|

| | | |
|-----------------------------|----------------|---|
| IFS-USB-PROG-ADAPTER | 2811271 | 1 |
|-----------------------------|----------------|---|

Measurement and control technology - MINI Analog Pro highly compact signal conditioners

Order key for MINI-MCR-2-POT-UI...C 3-way signal conditioner (standard configuration entered as an example)

| Order No. | Automatic potentiometer detection | Output | | | Filter | Open circuit detect | ... |
|---|-----------------------------------|----------------|---|---|---|----------------------|-----|
| | | Output signal | Start | End | | | |
| 2905005 | AUTO | I | 4.0 | 20.0 | 1 | ON | |
| 2905005 ≙ MINI-MCR-2- POT-UI-C | AUTO ≙ ON OFF ≙ OFF | I ≙ I U ≙ U | 0.0 ≙ 0 mA I: freely selectable between 0.0...21 mA U: freely selectable between 0.0...10.5 V | 20.0 ≙ 20 mA I: freely selectable between 0.0...21 mA U: freely selectable between 0.0...10.5 V | 1 2 3 4 5 6 7 8 9 10 | ON ≙ ON OFF ≙ OFF | |
| 2905006 ≙ MINI-MCR-2- POT-UI-PT-C | | | | | | | |

Failure information

Behavior in the event of an error

Open circuit slider

Input open (no potentiometer connected)

Overrange

Underrange

| ... | NE43DO | 0.0 | 0.0 | 0.0 | 0.0 |
|--|--|--|--|--|--|
| FD ≙ Freely definable | 0.0 ≙ 0 mA I: freely selectable between 0.0...21.5 mA U: freely selectable between 0.0...11 V (only if open circuit detection is on) (signal type corresponds to selected output signal) | 0.0 ≙ 0 mA I: freely selectable between 0.0...21.5 mA U: freely selectable between 0.0...11 V (signal type corresponds to selected output signal) | 0.0 ≙ 0 mA I: freely selectable between 0.0...21.5 mA U: freely selectable between 0.0...11 V (signal type corresponds to selected output signal) | 0.0 ≙ 0 mA I: freely selectable between 0.0...21.5 mA U: freely selectable between 0.0...11 V (signal type corresponds to selected output signal) | 0.0 ≙ 0 mA I: freely selectable between 0.0...21.5 mA U: freely selectable between 0.0...11 V (signal type corresponds to selected output signal) |
| Note: failure information according to NE 43 can only be selected for 4...20 mA output | | | | | |
| NE43UP ≙ NE 43 upscale NE43DO ≙ NE 43 downscale NE430 ≙ NE 43 0 mA NE43UD ≙ NE 43 upscale/downscale | 21.5 mA 3.5 mA 0 mA 3.5 mA | 21.5 mA 3.5 mA 0 mA 3.5 mA | 21.5 mA 3.5 mA 0 mA 3.5 mA | 21.5 mA 3.5 mA 0 mA 21.5 mA | 21.5 mA 3.5 mA 0 mA 21.5 mA |

Accessories

ME 6,2 TBUS... DIN rail connector

- For bridging the supply voltage
- Reduces wiring costs
- Module replacement without interrupting the supply to the remaining modules (hot swappable)
- One DIN rail connector for two MINI Analog modules
- Only distinguished by color coding



For bridging the supply voltage



For bridging the supply voltage

| Description |
|---|
| DIN rail connector (TBUS) , for bridging the supply voltage, can be snapped onto 35 mm DIN rails as per EN 60715, with UL approval |
| Color: green Color: gray |

| Ordering data | | |
|--------------------------------|-----------|-------------|
| Type | Order No. | Pcs. / Pkt. |
| ME 6,2 TBUS-2 1,5/5-ST-3,81 GN | 2869728 | 10 |

| Ordering data | | |
|--------------------------------|-----------|-------------|
| Type | Order No. | Pcs. / Pkt. |
| ME 6,2 TBUS-2 1,5/5-ST-3,81 GY | 2695439 | 10 |

Accessories

Power terminal blocks

- Power terminal block for supplying the supply voltage to the DIN rail connector
- Plug-in connection system
- Increased output current of 3.2 A
- Monitoring of supplies in combination with the fault monitoring module
- Flexible redundant supply from one or both module sides
- Status and error indicator LEDs

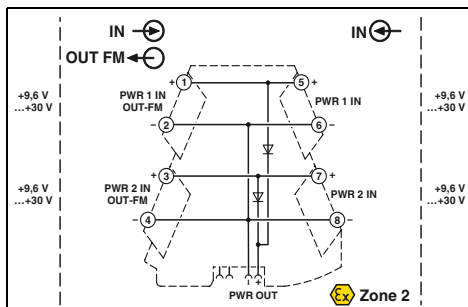

Redundant supply for existing 24 V

| Input data/output data |
|---------------------------------|
| Input voltage range |
| Output voltage |
| Output current |
| General data |
| Ambient temperature (operation) |
| Housing material |
| EMC note |
| Conformance / approvals |
| Conformance |
| ATEX |
| UL, USA / Canada |
| GL |

| Technical data |
|--|
| 9.9 V DC ... 30 V DC (Input voltage - 0.3 V) ≤ 3.2 A |
| -40°C ... 70°C |
| PBT |
| Class A product, see page 443 |
| CE-compliant |
| Ex II 3 G Ex nA IIC T4 Gc X |
| 508 listing applied for |
| Class I, Div. 2, Groups A, B, C, D T5 applied for |
| GL applied for |

| Description |
|---|
| MINI Analog Pro power terminal block |
| Push-in connection |
| Screw connection |

| Ordering data | | |
|-------------------|-----------|-------------|
| Type | Order No. | Pcs. / Pkt. |
| MINI MCR-2-PTB-PT | 2902067 | 1 |
| MINI MCR-2-PTB | 2902066 | 1 |

Accessories

ME 17,5 TBUS-... DIN rail connector

- For bridging the supply voltage when using a MINI POWER system power supply

Notes:

If the system power supply is used, two ME 17,5 TBUS DIN rail connectors are required. This allows you to establish the connection to the ME 6,2 TBUS DIN rail connector of the MINI Analog system and provide an effective power supply.

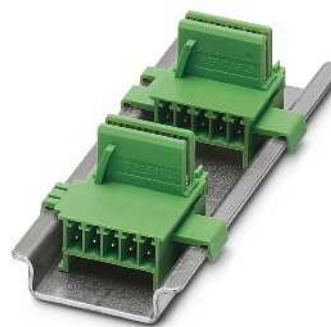

For system power supply

| |
|---|
| Description |
| DIN rail connector , for bridging the supply voltage, can be snapped onto 35 mm DIN rails as per EN 60715, with UL approval, two pieces are required per system power supply |

| Ordering data | | |
|--------------------------------|-----------|-------------|
| Type | Order No. | Pcs. / Pkt. |
| ME 17,5 TBUS 1,5/ 5-ST-3,81 GN | 2709561 | 10 |

Accessories

System power supply

- For supplying the supply voltage via the DIN rail connector where AC voltages are available
- 100 ... 240 V AC nominal input voltage range
- 24 V DC output voltage
- For up to 60 MINI Analog modules
- For up to 1.5 A, secondary
- Status and error signaling via diagnostic LEDs



For applications with local voltages of over 100 V

| |
|--|
| Description |
| System power supply , primary-switched, with zone 2 approval. Further information can be found in Catalog 6, Surge protection and power supplies. |
| System power supply , primary-switched (not for zone 2!) Further information can be found in Catalog 6, Surge protection and power supplies. |

| Ordering data | | |
|--------------------------------|-----------|-------------|
| Type | Order No. | Pcs. / Pkt. |
| MINI-PS-100-240AC/24DC/1.5/EX | 2866653 | 1 |
| MINI-SYS-PS-100-240AC/24DC/1.5 | 2866983 | 1 |

Accessories

Feed-through terminal blocks

- Feed-through terminal block for 1:1 forwarding of signals that are already electrically isolated in the MINI Analog Pro group
- Plug-in connection system

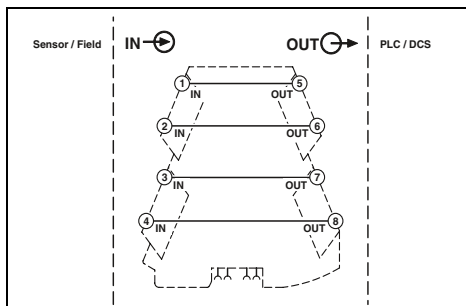

1:1 connection

| General data | |
|-------------------------------------|---|
| Degree of protection | IP20 |
| Ambient temperature (operation) | -40°C ... 70°C |
| Mounting | Any |
| Housing material | PBT |
| Dimensions W/H/D | 6.2/110.5/120.5 mm |
| Screw connection solid/stranded/AWG | 0.2 ... 1.5 mm ² /0.2 ... 1.5 mm ² /26 - 16 |
| Conformance / approvals | |
| Conformance | CE-compliant |
| ATEX | Ex II 3 G Ex nA IIC T4 Gc X |
| GL | GL applied for |

Technical data

| Degree of protection | IP20 |
|-------------------------------------|---|
| Ambient temperature (operation) | -40°C ... 70°C |
| Mounting | Any |
| Housing material | PBT |
| Dimensions W/H/D | 6.2/110.5/120.5 mm |
| Screw connection solid/stranded/AWG | 0.2 ... 1.5 mm ² /0.2 ... 1.5 mm ² /26 - 16 |
| Conformance / approvals | |
| Conformance | CE-compliant |
| ATEX | Ex II 3 G Ex nA IIC T4 Gc X |
| GL | GL applied for |

| Description | |
|--|------------------|
| MINI Analog Pro feed-through terminal block | |
| | Screw connection |

Ordering data

| Type | Order No. | Pcs. / Pkt. |
|----------------------|----------------|-------------|
| MINI MCR-2-TB | 2902068 | 1 |

Accessories

Error message modules

- Fault monitoring module for evaluating and reporting group errors from the fault monitoring system
- Monitoring of up to 115 connected MINI Analog Pro modules
- Plug-in connection system
- Monitoring of supply voltages of MINI MCR-2-PTB-(PT) power terminal blocks
- Drawing off the supply is possible
- Fault signaling via an N/C contact
- Status and error indicator LEDs

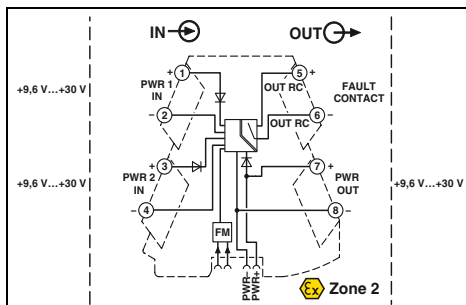

Group error message and supply monitoring

| Input data/output data | |
|---------------------------|--|
| Input signal | 9.9 V DC ... 30 V DC |
| Output signal | 9.6 V DC ... 29.7 V DC |
| Switching output | |
| Max. switching voltage | 30 V DC |
| Max. switching current | 50 mA |
| General data | |
| Test voltage input/output | 1.5 kV AC (50 Hz, 1 min.) |
| EMC note | Class A product, see page 443 |
| Conformance / approvals | |
| Conformance | CE-compliant |
| ATEX | Ex II 3 G Ex nA IIC T4 Gc X |
| UL, USA / Canada | 508 listing applied for Class I, Div. 2, Groups A, B, C, D T5 applied for |
| GL | GL applied for |

Technical data

| Input signal | 9.9 V DC ... 30 V DC |
|---------------------------|-------------------------------|
| Output signal | 9.6 V DC ... 29.7 V DC |
| Switching output | |
| Max. switching voltage | 30 V DC |
| Max. switching current | 50 mA |
| General data | |
| Test voltage input/output | 1.5 kV AC (50 Hz, 1 min.) |
| EMC note | Class A product, see page 443 |

| Description | |
|---|--------------------|
| MINI Analog Pro error signaling module | |
| | Push-in connection |
| | Screw connection |

Ordering data

| Type | Order No. | Pcs. / Pkt. |
|----------------------------|----------------|-------------|
| MINI MCR-2-FM-RC-PT | 2904508 | 1 |
| MINI MCR-2-FM-RC | 2904504 | 1 |

Accessories

Programming adapter

IFS-USB-PROG-ADAPTER programming adapter for configuring Phoenix Contact INTERFACE modules with S-PORT interface.

The adapter is used with FDT/DTM software or ANALOG-CONF software. For programming MACX Analog and MINI Analog.



| General data | | Technical data | | |
|---|--|-------------------------------|-----------|-------------|
| EMC note | | Class A product, see page 443 | | |
| Description | | Ordering data | | |
| Programming adapter for configuring modules with S-PORT interface | | Type | Order No. | Pcs. / Pkt. |
| | | IFS-USB-PROG-ADAPTER | 2811271 | 1 |

Accessories

Marking label for transparent cover

- Snap-in labels and adhesive labels with large-area for marking
- For snapping into or sticking onto MINI Analog Pro covers, without overlapping the status and error LEDs
- The sheets can be marked quickly and easily using the BLUEMARK CLED and the THERMOMARK CARD..
- They can also be custom printed according to customer requirements



| Description | | Ordering data | | | Ordering data | | |
|--|-------|--------------------|-----------|-------------|----------------|-----------|-------------|
| Description | Color | Type | Order No. | Pcs. / Pkt. | Type | Order No. | Pcs. / Pkt. |
| UniCard, can be labeled with THERMOMARK CARD and BLUEMARK | | | | | | | |
| Lettering field size: 30 x 5 mm | white | UCT-EM (30X5) | 0801505 | 10 | | | |
| Lettering field size: 30 x 5 mm | white | UCT-EM (30X5) CUS | 0801589 | 1 | | | |
| 10-section, lettering field size: 15 x 5 mm | white | UC-EMLP (15X5) | 0819301 | 10 | | | |
| 10-section, lettering field size: 15 x 5 mm | white | UC-EMLP (15X5) CUS | 0824550 | 1 | | | |
| Self-adhesive marker strips, unprinted, continuous, material off the roll, for marking with thermal transfer printer, can be separated using cutter, pitch as desired, strip length of up to 1000 mm, 10 strips, strip height of 5.0 mm, 1 roll = 90 m | | | | | | | |
| | white | | | | SK 5,0 WH:REEL | 0805221 | 1 |



Integrate analog signals safely

Integrate analog signals easily into your safety application according to the Machinery Directive. The MACX Safety analog signal conditioners are certified according to EN ISO 13849-1 with performance level PL d.

Ex i signals

MACX Safety Ex enables the easy and safe processing of intrinsically safe analog signals according to the Machinery Directive.

Cost savings

- Direct safe shutdown without an additional safety controller or in conjunction with a small-scale controller from Phoenix Contact offers a clear cost advantage
- Further cost savings can be made thanks to easy configuration and easy integration in the safety chain
- Versions with push-in technology save installation time

Choose the right MACX Safety signal conditioner for your application:

Analog IN

- 4...20 mA repeater power supplies and input signal conditioners with 2 electrically isolated outputs

Temperature

- Universal temperature transducers for resistance thermometers, resistance-type sensors, potentiometers, thermocouples, and mV sources – with safe limit value relay

Functional safety – from the initial idea to the finished product

Phoenix Contact meets the requirements of functional safety according to IEC 61508 in a standardized development process. Here, all fault avoidance and fault control measures are taken into consideration, from the very development and production of a device right up to device operation. The devices are examined by an independent test center.



DIN rail connector-compatible

The DIN rail connector enables the modular bridging of the 24 V supply voltage.



Wide range supply

The modules featuring a wide range supply (...-UP) can be used in all power supply networks the world over without the need for additional power supply units.



Safe and reliable functions

- Consistent PL d and SIL certification. This ensures the highest level of reliability and safety for your systems.

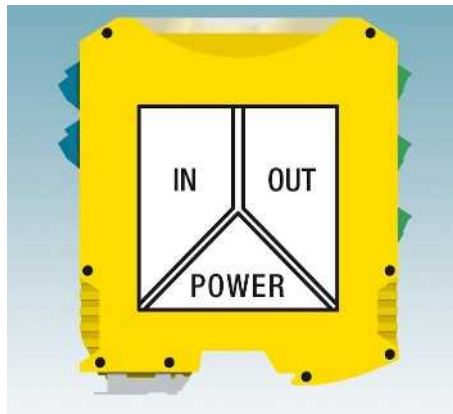

Precise transmission and high operational reliability

- Thanks to patented transmission concept
- Safe electrical isolation.

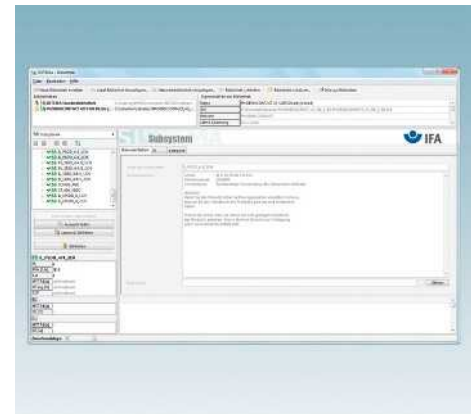

Easy integration with Sistema

- Easy integration into the safety chain via Sistema. The required data is already stored in Sistema.



Easy configuration and monitoring

- Easy configuration and monitoring with the ANALOG-CONF stand-alone software with integrated monitoring function or with FDT/DTM.



Easy to combine

- Analog signals, whether passive or active, can be easily combined with other safety modules.

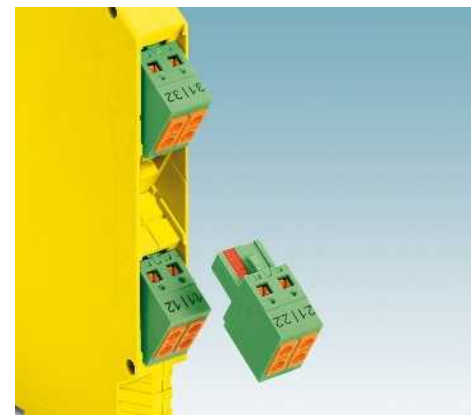

Easy-maintenance connection technology

- Plug-in connection terminal blocks with screw connection or fast push-in technology - coded, with integrated sockets.

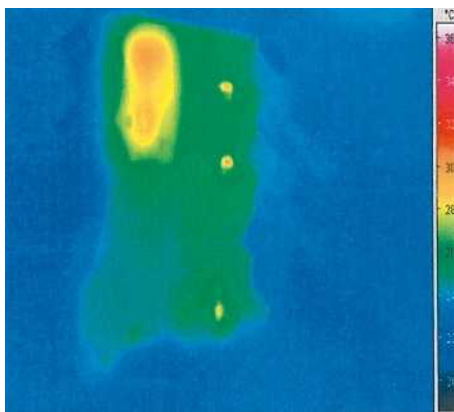

Precise transmission, long service life

- Patented circuit concepts ensure precise signal transmission and minimal self-heating.



Even for the Ex area

- Maximum explosion protection for all Ex zones with the MACX Safety Ex range as associated intrinsically safe equipment and for installation in zone 2.



Direct safety shutdown

- Simple and direct shutdown for small applications is possible without an expensive safety controller or in conjunction with a small-scale controller.

Analog IN

Repeater power supplies

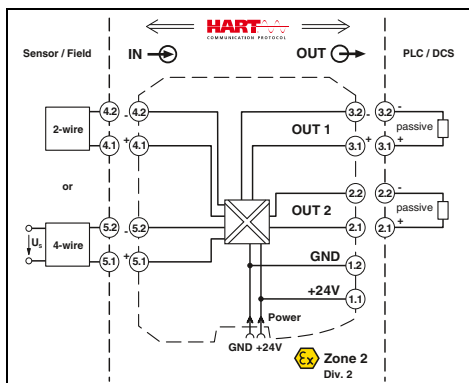
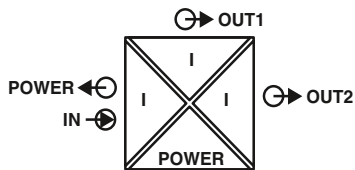

Ex n



Repeater power supply and input signal conditioner, with two electrically isolated outputs

Housing width 12.5 mm

Technical data

- 4...20 mA input, powered and not powered
- Two electrically isolated 4...20 mA (active) outputs
- PL d according to EN ISO 13849-1
- Up to SIL 2 according to EN 61508
- Installation in zone 2 possible
- Plug-in screw and push-in connection technology
- 4-way electrical isolation
- Bidirectional HART communication possible
- Power supply via DIN rail connector possible

| | |
|---|---|
| Input data | |
| Input signal | 4 mA ... 20 mA/4 mA ... 20 mA |
| Transmitter supply voltage | > 21.5 V (at 20 mA) |
| Voltage drop | < 3.9 V (in input signal conditioner operation) |
| Output data | |
| Output signal (per output) | 4 mA ... 20 mA (active) |
| Load | < 450 Ω (at 20 mA) |
| Output ripple | < 20 mV _{rms} |
| General data | |
| Supply voltage range | 19.2 V DC ... 30 V DC (24 V DC (-20% ... +25%)) |
| Current consumption | < 75 mA (at 24 V DC) |
| Power dissipation | < 1.45 W (at 24 V DC/20 mA) |
| Temperature coefficient | < 0.01%/K |
| Step response (10-90%) | < 1.3 ms (for 4 mA ... 20 mA step) |
| Transmission error, typical | < 0.05% (of final value) |
| Maximum transmission error | < 0.1% (of final value) |
| Under-/overload range | According to NE 43 |
| Electrical isolation | |
| Input/output/power supply | 300 V _{rms} (rated insulation voltage (surge voltage category II; pollution degree 2, safe isolation as per EN 61010-1)) 2.5 kV (50 Hz, 1 min., test voltage) |
| Output 1/output 2 | 1.5 kV AC (50 Hz, 1 min., test voltage) -20°C ... 60°C (any mounting position) Green LED (PWR supply voltage) Yes HART PA 66-FR 12.5/99/114.5 mm 0.2 ... 2.5 mm ² /0.2 ... 2.5 mm ² /24 - 14 0.2 ... 1.5 mm ² /0.2 ... 1.5 mm ² /24 - 16 Class A product, see page 443 |
| Ambient temperature range | |
| Status indication | |
| SMART communication (per output) | |
| Protocols supported | |
| Housing material | |
| Dimensions W/H/D | |
| Screw connection solid/stranded/AWG | |
| Spring-cage connection (solid/stranded/AWG) | |
| EMC note | |
| Conformance / approvals | |
| Conformance | CE-compliant, additionally EN 61326 |
| ATEX | Ex II 3 G Ex nA IIC T4 Gc X |
| SIL in accordance with IEC 61508 | 2 |
| Performance level according to ISO 13849 | PLd |

Ordering data

| Description | Type | Order No. | Pcs. / Pkt. | |
|--|------------------------|---------------------|-------------|---|
| Repeater power supplies and input signal conditioners, signal duplicator, with performance level | Screw connection | MACX PL-RPSSI-2I | 2904961 | 1 |
| | Spring-cage connection | MACX PL-RPSSI-2I-SP | 2904962 | 1 |

Temperature, temperature transducer



Universal, with limit value relays, wide range power supply



Housing width 35 mm

Technical data

| | | |
|--------------------------------------|--|--|
| Input data | Resistance thermometers Thermocouple sensors | Pt, Ni, Cu sensors: 2, 3, 4-wire B, E, J, K, N, R, S, T, L, U, CA, DA, A1G, A2G, A3G, MG, LG |
| Resistor Potentiometer Voltage | | 0 Ω ... 50 kΩ 0 Ω ... 50 kΩ -1000 mV ... 1000 mV |
| Output data | Output signal Maximum output signal Load R _B Behavior in the event of a sensor error | 4 mA ... 20 mA 22 mA ≤ 600 Ω (at 20 mA) According to NE 43 or freely configurable |
| Switching output | Contact type Contact material Max. switching voltage Max. switching current | Relay output 2 PDT AgSnO ₂ , hard gold-plated 250 V AC (250 V DC) 2 A (250 V AC)/2 A (28 V DC) |
| General data | Supply voltage range Power consumption Temperature coefficient Maximum transmission error Electrical isolation | 24 V ... 230 V AC/DC (-20%/+10%, 50/60 Hz) < 2.4 W 0.01%/K 0.1% (e.g. for Pt 100, 300 K span, 4 ... 20 mA) |
| | Input/output/power supply | 300 V _{ins} (rated insulation voltage (surge voltage category II; pollution degree 2, safe isolation as per EN 61010-1)) 2.5 kV (50 Hz, 1 min., test voltage) |
| | Input/output Input/power supply Input/switching output | 375 V (peak value in accordance with EN 60079-11) 375 V (peak value in accordance with EN 60079-11) 375 V (peak value in accordance with EN 60079-11) -20°C ... 65°C Typ. 5% ... 95% (non-condensing) PA 66-FR V0 35/99/114.5 mm 0.2 ... 2.5 mm ² /0.2 ... 2.5 mm ² /24 - 14 0.2 ... 1.5 mm ² /0.2 ... 1.5 mm ² /24 - 16 Class A product, see page 443 |
| Conformance / approvals | Ambient temperature range Humidity Housing material Inflammability class in acc. with UL 94 Dimensions W/H/D Screw connection solid/stranded/AWG Spring-cage connection (solid/stranded/AWG) EMC note | CE-compliant Ex II 3 G Ex nA nC ic IIC T4 Gc X Ex nA nC ic IIC T4 Gc X 2 PLd |
| | Conformance ATEX IECEX SIL in accordance with IEC 61508 Performance level according to ISO 13849 | |

- Input for resistance thermometers, thermocouples, resistance-type sensors, potentiometers, mV sources
- A safety-related limit value relay, by bridging two relays
- Differential measurement possible with Pt 100
- An additional limit value relay for non-safety-related function
- PL d according to EN ISO 13849-1
- Up to SIL 2 according to EN 61508
- Configuration via software (ANALOG-CONF or FDT/DTM)
- Cold junction compensation with separate plug
- Wide range power supply 19.2 ... 253 V AC/DC
- Status indicators for supply voltage, cable, sensor, and module errors
- Installation in zone 2 possible
- Plug-in screw and push-in connection technology

Ordering data

| Description | Type | Order No. | Pcs. / Pkt. | |
|---|------------------------|-----------------------|-------------|---|
| Temperature transducer and threshold value switch with performance level | Screw connection | MACX PL-T-UIREL-UP | 2904901 | 1 |
| | Spring-cage connection | MACX PL-T-UIREL-UP-SP | 2904903 | 1 |

Accessories

| | | | |
|--|----------------------|---------|---|
| Programming adapter for configuring modules with S-PORT interface | IFS-USB-PROG-ADAPTER | 2811271 | 1 |
| Plug with 50 Ω resistor , for current signals between +20 mA and -20 mA | MACX MCR-I20 | 2905680 | 1 |

Analog IN

Repeater power supply, Ex i

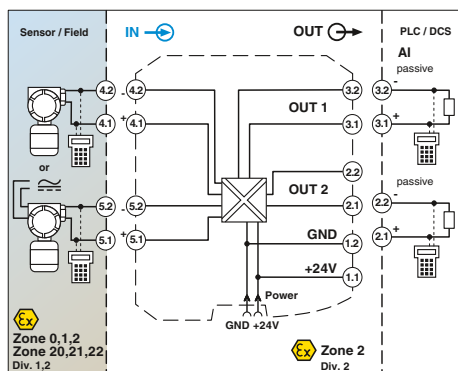

Repeater power supply and input signal conditioner, with two electrically isolated outputs

Housing width 12.5 mm

Technical data

- 4...20 mA input, [Ex ia], powered and not powered
- Two electrically isolated 4...20 mA (active) outputs
- PL d according to EN ISO 13849-1
- Up to SIL 2 according to EN 61508
- Installation in zone 2 possible
- Plug-in screw and push-in connection technology
- 4-way electrical isolation
- Bidirectional HART communication possible
- Power supply via DIN rail connector possible

Input data

Input signal
Transmitter supply voltage
Voltage drop

Output data

Output signal (per output)
Load
Output ripple

General data

Supply voltage range
Current consumption
Power dissipation
Temperature coefficient
Step response (10-90%)
Transmission error, typical
Maximum transmission error
Under-/overload range
Electrical isolation

Input/output/power supply

Input/output
Input/power supply
Output 1/output 2

Ambient temperature range

Status indication
SMART communication (per output)

Protocols supported

Housing material
Dimensions W/H/D
Screw connection solid/stranded/AWG
Spring-cage connection (solid/stranded/AWG)

EMC note

Safety data as per ATEX

Max. output voltage U_o
Max. output current I_o
Max. output power P_o
Maximum voltage U_m

Conformance / approvals

Conformance
ATEX

IECEX

SIL in accordance with IEC 61508
Performance level according to ISO 13849

4 mA ... 20 mA/4 mA ... 20 mA
> 16 V (at 20 mA)
< 3.9 V (in input signal conditioner operation)

4 mA ... 20 mA (active)
< 450 Ω (at 20 mA)
< 20 mV_{rms}

19.2 V DC ... 30 V DC (24 V DC (-20% ... +25%))
< 75 mA (24 V DC/ 20 mA)
< 1.45 W (24 V DC/ 20 mA)
< 0.01%/K
< 1.3 ms (for 4 mA ... 20 mA step)
< 0.05% (of final value)
< 0.1% (of final value)
According to NE 43

300 V_{rms} (rated insulation voltage (surge voltage category II; pollution degree 2, safe isolation as per EN 61010-1))
2.5 kV (50 Hz, 1 min., test voltage)

375 V (peak value in accordance with EN 60079-11)
375 V (peak value in accordance with EN 60079-11)
1.5 kV AC (50 Hz, 1 min., test voltage)
-20°C ... 60°C (any mounting position)
Green LED (PWR supply voltage)
Yes
HART
PA 66-FR
12.5/99/114.5 mm
0.2 ... 2.5 mm²/0.2 ... 2.5 mm²/24 - 14
0.2 ... 1.5 mm²/0.2 ... 1.5 mm²/24 - 16
Class A product, see page 443

252 V
93 mA
587 mW
253 V AC (125 V DC)

CE-compliant, additionally EN 61326

Ex II (1) G [Ex ia Ga] IIC/IIB
Ex II (1) D [Ex ia Da] IIIC
Ex II 3 (1) G Ex nA [ia Ga] IIC/IIB T4 Gc
[Ex ia Ga] IIC/IIB, [Ex ia Da], Ex nA [ia Ga] IIC/IIB T4 Gc
2
PLd

Ordering data

Description

Repeater power supplies and input signal conditioners, signal duplicator, with performance level, intrinsically safe input

Screw connection
Spring-cage connection

| Type | Order No. | Pcs. / Pkt. |
|------------------------|-----------|-------------|
| MACX PL-EX-RPSSI-2I | 2904959 | 1 |
| MACX PL-EX-RPSSI-2I-SP | 2904960 | 1 |

Analog IN

Repeater power supply, Ex i

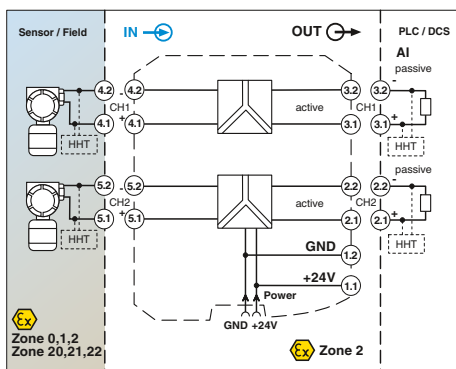
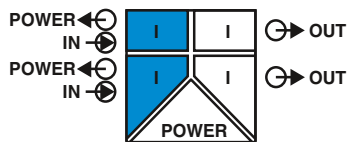

2-channel repeater power supply

- 2-channel
- 4...20 mA input, [Ex ia], powered
- 4 ... 20 mA output (active)
- PL d according to EN ISO 13849-1
- Up to SIL 3 according to IEC 61508
- Installation in zone 2 possible
- Plug-in screw and push-in connection technology
- 3-way electrical isolation, per channel
- Bidirectional HART communication possible
- Power supply via DIN rail connector possible

| | |
|---|--|
| Input data | |
| Input signal | |
| Transmitter supply voltage | |
| Underload/overload signal range | |
| Output data | |
| Output signal | |
| Load | |
| Underload/overload signal range | |
| General data | |
| Supply voltage range | |
| Current consumption | |
| Power dissipation | |
| Temperature coefficient | |
| Step response (10-90%) | |
| Transmission error, typical | |
| Maximum transmission error | |
| Electrical isolation | |
| Input/output, power supply | |
| Input/output | |
| Input/power supply | |
| Output 1/output 2/ power supply | |
| Ambient temperature range | |
| Status indication | |
| SMART communication | |
| Signal bandwidth | |
| Protocols supported | |
| Housing material | |
| Dimensions W/H/D | |
| Screw connection solid/stranded/AWG | |
| Spring-cage connection (solid/stranded/AWG) | |
| EMC note | |
| Safety data as per ATEX | |
| Max. output voltage U_o | |
| Max. output current I_o | |
| Max. output power P_o | |
| Maximum voltage U_m | |
| Conformance / approvals | |
| Conformance | |
| ATEX | |
| IECEx | |
| SIL in accordance with IEC 61508 | |
| Performance level according to ISO 13849 | |

Ex: Ex

Housing width 12.5 mm

Technical data

| | |
|---|--|
| per channel | |
| 4 mA ... 20 mA | |
| > 16 V (at 20 mA) | |
| 0 mA ... 24 mA | |
| per channel | |
| 4 mA ... 20 mA (active) | |
| ≤ 450 Ω (20 mA) | |
| 0 mA ... 24 mA | |
| 19.2 V DC ... 30 V DC (24 V DC (-20% ... +25%)) | |
| < 100 mA (24 V/20 mA) | |
| < 1.4 W (at 24 V DC/20 mA) | |
| < 0.01%/K | |
| < 1.3 ms (for 4 mA ... 20 mA step) | |
| < 0.05% (of final value) | |
| < 0.1% (of final value) | |
| 300 V _{rms} (rated insulation voltage (surge voltage category II; pollution degree 2, safe isolation as per EN 61010-1)) | |
| 2.5 kV (50 Hz, 1 min., test voltage) | |
| 375 V (peak value in accordance with EN 60079-11) | |
| 375 V (peak value in accordance with EN 60079-11) | |
| 1.5 kV (50 Hz, 1 min., test voltage) | |
| -20°C ... 60°C (any mounting position) | |
| Green LED (supply voltage) | |
| Yes | |
| as per HART specifications | |
| HART | |
| PA 66-FR | |
| 12.5/99/114.5 mm | |
| 0.2 ... 2.5 mm ² /0.2 ... 2.5 mm ² /24 - 14 | |
| 0.2 ... 1.5 mm ² /0.2 ... 1.5 mm ² /24 - 16 | |
| Class A product, see page 443 | |
| 25.2 V | |
| 93 mA | |
| 587 mW | |
| 253 V AC (125 V DC) | |
| CE-compliant, additionally EN 61326 | |
| Ex II (1) G [Ex ia Ga] IIC/IIB | |
| Ex II (1) D [Ex ia Da] IIIC | |
| Ex II 3(1) G Ex nA [ia Ga] IIC T4 Gc | |
| [Ex ia Ga] IIC/IIB, [Ex ia Da] IIIC, Ex nA [ia Ga] IIC T4 Gc | |
| 3 | |
| PLd | |

Ordering data

| Description | Type | Order No. | Pcs. / Pkt. |
|--|--------------------------|-----------|-------------|
| Repeater power supply, two-channel, with performance level, intrinsically safe input | | | |
| Screw connection | MACX PL-EX-RPSS-2I-2I | 2904963 | 1 |
| Spring-cage connection | MACX PL-EX-RPSS-2I-2I-SP | 2904964 | 1 |

Temperature

Temperature transducer, Ex i

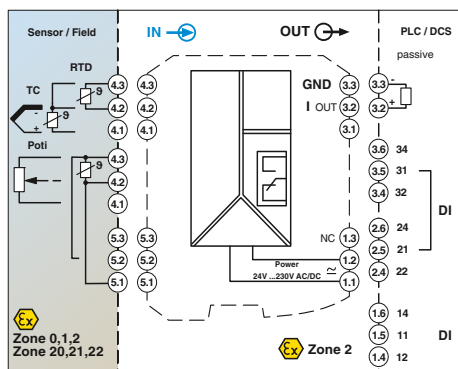
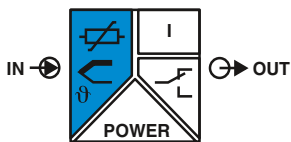

Universal, with limit value relays, wide range power supply

Housing width 35 mm

Technical data

- Input for resistance thermometers, thermocouples, resistance-type sensors, potentiometers, mV sources, [Ex ia]
- Differential measurement possible with Pt 100
- A safety-related limit value relay, by bridging two relays
- An additional limit value relay for non-safety-related function
- PL d according to EN ISO 13849-1
- Up to SIL 2 according to EN 61508
- Configuration via software (ANALOG-CONF or FDT/DTM)
- Cold junction compensation with separate plug
- Wide range power supply 19.2 ... 253 V AC/DC
- Status indicators for supply voltage, cable, sensor, and module errors
- Installation in zone 2 possible
- Plug-in screw and push-in connection technology

| | |
|--|--|
| Input data | Resistance thermometers Thermocouple sensors |
| Resistor | Potentiometer |
| Voltage | |
| Output data | |
| Output signal | |
| Maximum output signal | |
| Load R_B | |
| Behavior in the event of a sensor error | |
| Switching output | |
| Contact type | |
| Contact material | |
| Max. switching voltage | |
| Max. switching current | |
| General data | |
| Supply voltage range | |
| Power consumption | |
| Temperature coefficient | |
| Maximum transmission error | |
| Electrical isolation | |
| Input/output/power supply | 2.5 kV (50 Hz, 1 min., test voltage) |
| Input/output | 375 V (peak value in accordance with EN 60079-11) |
| Input/power supply | 375 V (peak value in accordance with EN 60079-11) |
| Input/switching output | 375 V (peak value in accordance with EN 60079-11) |
| Output/supply | 300 V _{rms} (rated insulation voltage (surge voltage category II; pollution degree 2, safe isolation as per EN 61010-1)) |
| Ambient temperature range | -20°C ... 65°C |
| Humidity | Typ. 5% ... 95% (non-condensing) |
| Housing material | PA 66-FR |
| Inflammability class in acc. with UL 94 | V0 |
| Dimensions W/H/D | 35/99/114.5 mm |
| Screw connection solid/stranded/AWG | 0.2 ... 2.5 mm ² /0.2 ... 2.5 mm ² /24 - 14 |
| Spring-cage connection (solid/stranded/AWG) | 0.2 ... 1.5 mm ² /0.2 ... 1.5 mm ² /24 - 16 |
| EMC note | Class A product, see page 443 |
| Safety data as per ATEX | |
| Max. output voltage U_o | 6 V |
| Max. output current I_o | 7.4 mA |
| Max. output power P_o | 11 mW |
| Conformance / approvals | |
| Conformance | CE-compliant |
| ATEX | [Ex] II (1) G [Ex ia Ga] IIC [Ex] II (1) D [Ex ia Da] IIIC [Ex] II 3 G Ex nA nC ic IIC T4 Gc X [Ex ia Ga] IIC, [Ex ia Da] IIIC, Ex nA nC ic IIC T4 Gc X |
| IECEX | 2 |
| SIL in accordance with IEC 61508 | PLd |
| Performance level according to ISO 13849 | |

Pt, Ni, Cu sensors: 2, 3, 4-wire
B, E, J, K, N, R, S, T, L, U, CA, DA, A1G, A2G, A3G, MG, LG

0 Ω ... 50 kΩ
0 Ω ... 50 kΩ
-1000 mV ... 1000 mV

4 mA ... 20 mA
22 mA
≤ 600 Ω (20 mA)
According to NE 43 or freely configurable

Relay output
2 PDT
AgSnO₂, hard gold-plated
250 V AC (250 V DC)
2 A (250 V AC)/2 A (28 V DC)

24 V ... 230 V AC/DC (-20%/+10%, 50/60 Hz)
< 2.4 W
0.01%/K
0.1% (e.g. for Pt 100, 300 K span, 4 ... 20 mA)

300 V_{rms} (rated insulation voltage (surge voltage category II; pollution degree 2, safe isolation as per EN 61010-1))

CE-compliant
[Ex] II (1) G [Ex ia Ga] IIC
[Ex] II (1) D [Ex ia Da] IIIC
[Ex] II 3 G Ex nA nC ic IIC T4 Gc X
[Ex ia Ga] IIC, [Ex ia Da] IIIC, Ex nA nC ic IIC T4 Gc X
2
PLd

Ordering data

| Type | Order No. | Pcs. / Pkt. |
|--------------------------|-----------|-------------|
| MACX PL-EX-T-UIREL-UP | 2904910 | 1 |
| MACX PL-EX-T-UIREL-UP-SP | 2904912 | 1 |

Accessories

| | | |
|----------------------|---------|---|
| IFS-USB-PROG-ADAPTER | 2811271 | 1 |
| MACX MCR-EX-I20 | 2905679 | 1 |

| | |
|--------------------|--|
| Description | Temperature transducer with threshold value switch, with performance level, intrinsically safe input |
| | Screw connection |
| | Spring-cage connection |

| |
|--|
| Programming adapter for configuring modules with S-PORT interface |
| Plug with 50 Ω resistor , for current signals between +20 mA and -20 mA |

Configuration software ANALOG-CONF and FDT/DTM

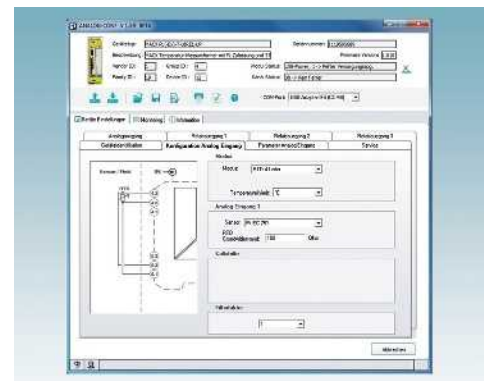
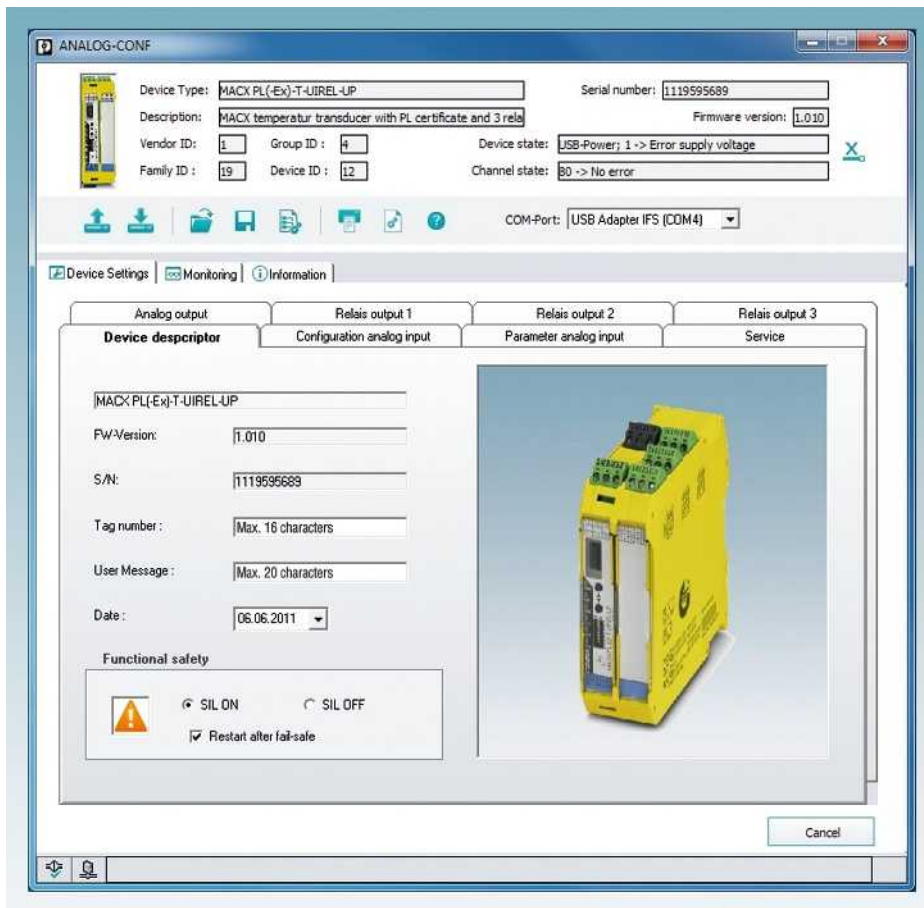

Input configuration with indication of the pin assignment

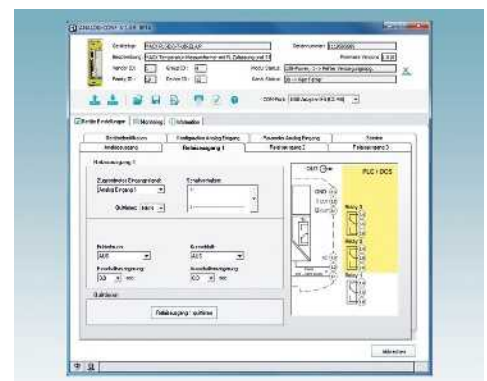

Relay configuration

ANALOG-CONF

The user-friendly ANALOG-CONF software allows you to quickly and clearly configure the temperature modules. The pin assignment for the input and output is directly displayed. You have access to the complete range of configurable parameters. You have the option to pre-configure parameters and then import them into any number of temperature transducers or read the data from the device and directly display the settings and measured values.

FDT/DTM

Configuration is also possible via the FDT/DTM universal configuration tool. The DTM files can simply be downloaded in the download area for the item.

The following parameters can be configured:

- Restart following failsafe

Input:

- Resistance thermometer
- Thermocouples
- Potentiometer
- Remote resistance-type sensor
- Voltage signals ± 1 V
- User characteristic curve
- Additional analog signals
- Filter
- Cold junction

Analog output:

- Type of fault signaling

Switching outputs:

- Acknowledgement, switching behavior
- Switch-on/off delay

Monitoring:

- Representation in diagram or value list, recording possible

Service:

- Reset, password protection, display DIP switch position
- and much more

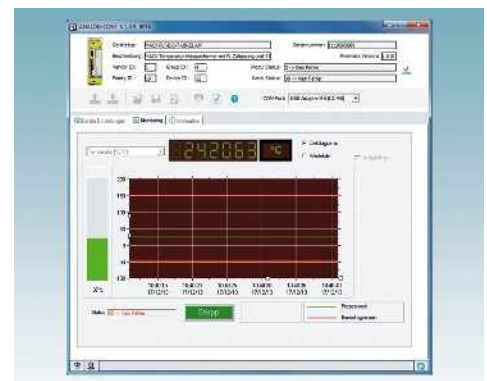

Monitoring function

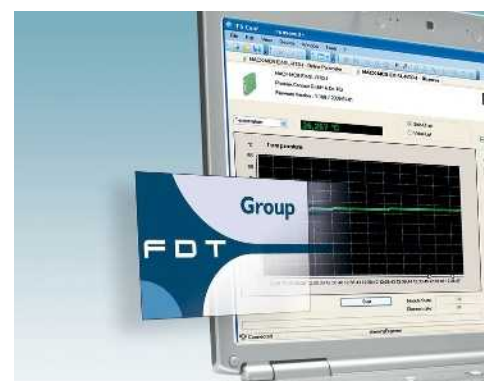

Configuration with FDT/DTM

Software for acquisition of usage data

The EMwise software from Phoenix Contact is the efficient solution for acquiring energy data regarding heat, cold, air or electricity in conjunction with a small-scale controller.

Integrate up to 24 digital inputs, 8 analog channels, 50 EMpro energy meters, 30 M-bus counters, and 4 IO-Link measuring sensors.

A web-based interface is available for system parameterization. Each device/channel can be configured individually, without any programming knowledge. The configuration is saved to a file and can be reused for identical systems.

Your advantages:

- Startup without programming knowledge
- Direct parameterization of predefined sensors

Three software versions, suitable for every application:

- EMWISE IMPULS: for up to 16 digital signals
- EMWISE IMP ANALOG: for up to 16 digital and 6 analog signals
- EMWISE EXTENDED: for up to 24 digital and 8 analog signals, EMpro energy meters, M-bus counters, M-bus level converters, IO-Link sensors



Technical data

See phoenixcontact.net/products

Ordering data

| Description |
|---|
| Program and configuration memory , plug-in, 2 GB with license key and application program for reading from measuring devices via pulses |
| Program and configuration memory , plug-in, 2 GB with license key and application program for reading from measuring devices via pulses and analog values |
| Program and configuration memory , plug-in, 2 GB with license key and application program for reading from measuring devices via pulses, analog values, M-bus, Modbus RTU, and IO-Link |

| Type | Order No. | Pcs. / Pkt. |
|--------------------------------|-----------|-------------|
| SD FLASH 2GB EMWISE IMPULS | 2701745 | 1 |
| SD FLASH 2GB EMWISE IMP ANALOG | 2701746 | 1 |
| SD FLASH 2GB EMWISE EXTENDED | 2701747 | 1 |

Software for data logging

Turn your controller into a data logger. The SD FLASH 512MB ILDLC FLEX memory card from Phoenix Contact provides all the software needed to extend your PLC for use as a data logger. The software contains the familiar application from the FLEX data logger kit.

In conjunction with the ILC 151 GSM/GPRS small-scale controller, 3 digital and 4 analog input or output terminal blocks can be mounted. The mounted terminals are automatically detected and started up by the controller. Different PCP channels can also be selected during parameterization.

Your advantages:

- Send digital and analog status information via SMS or e-mail or write it to an SQL database
- Startup without programming knowledge



Technical data

See phoenixcontact.net/products

Ordering data

| Description |
|---|
| SD FLASH card with data logger FLEX application |

| Type | Order No. | Pcs. / Pkt. |
|---------------------------|-----------|-------------|
| SD FLASH 512MB ILDLC FLEX | 2701873 | 1 |

Pressure sensor with IO-Link

Pressure sensors from Phoenix Contact detect the operating pressure of gas media in a range from -1 to 10 bar. The overload-proof ceramic measuring cell is designed for in excess of 100 million cycles and enables a high switching point accuracy. The pressure switch offers the option of using the set switching points via two switching outputs or reading all process data via the IO-Link interface.

Your advantages:

- IO-Link communication
- Parameterization, diagnostics, and process value monitoring via IO-Link
- Programmable function
- 4-character alphanumeric display

 IO-Link



| |
|--|
| Pressure monitoring |
| Measuring range |
| Pressure resistance |
| Process connection |
| Supply for module electronics |
| Connection method |
| No. of pos. |
| Supply voltage range |
| Current draw |
| Digital outputs |
| Number of outputs |
| Connection method |
| Delay time |
| IO-Link |
| Specification |
| Transmission speed |
| General data |
| Weight |
| Width |
| Height |
| Depth |
| Degree of protection |
| Protection class |
| Ambient temperature (operation) |
| Ambient temperature (storage/transport) |
| Vibration resistance in acc. with EN 60068-2-6/IEC 60068-2-6 |

Technical data

| |
|---|
| -1 bar ... 10 bar (minimum burst pressure 150 bar) |
| 75 bar |
| G1/4 I |
| M12 connector |
| 4 |
| 18 V DC ... 36 V DC |
| < 35 mA |
| 2 (OUT1 = switching output, OUT2 = switching output or diagnostic output) |
| M12 connectors, assigned four times |
| 0.3 s (operational readiness) |
| V1.1 |
| (38.4 kbaud) |
| 263 g |
| 34 mm |
| 91.5 mm |
| 48 mm |
| IP65 |
| III |
| -25°C ... 80°C |
| -40°C ... 100°C |
| 20g (10 Hz ... 2000 Hz) |

| |
|--|
| Description |
| Pressure switch with indicator, G1/4 I process connection, IO-Link communication |

Ordering data

| Type | Order No. | Pcs. / Pkt. |
|----------------|-----------|-------------|
| PSK APS7004IOL | 2700710 | 1 |

Current transformers for retrofitting PACT RCP

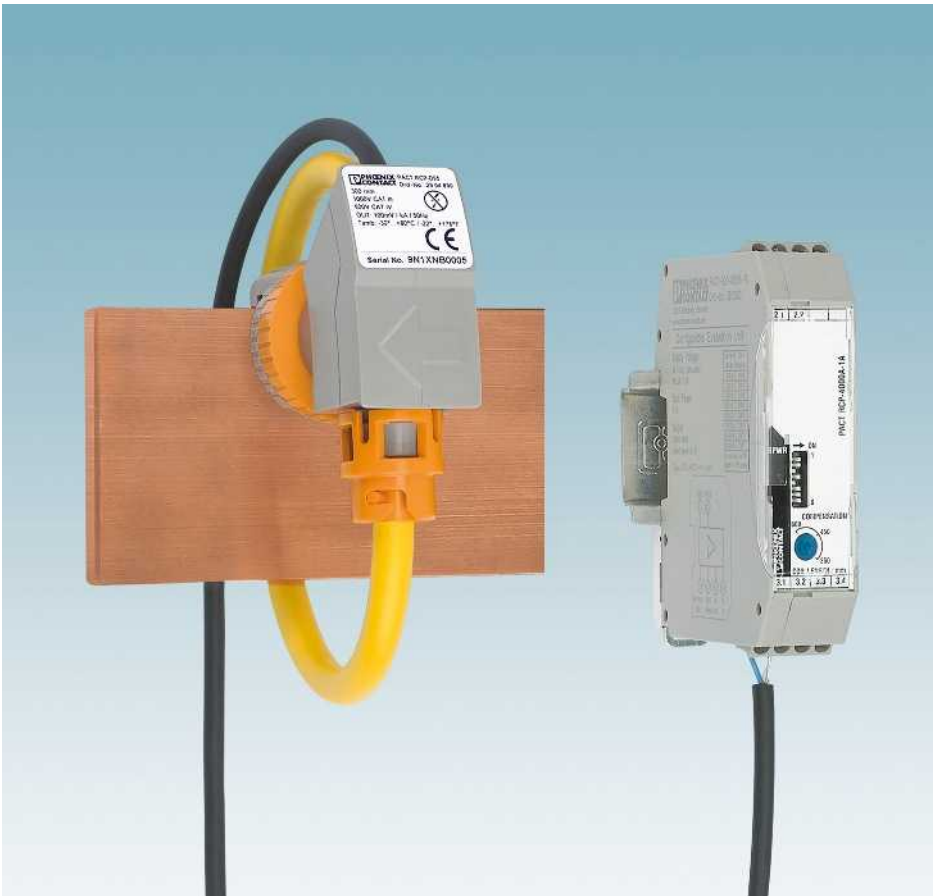

Fast installation without removing system parts



Eight different current measuring ranges from 100 to 4000 A

Fast installation in a confined space

PACT current transformers for retrofitting can be conveniently mounted where there is not enough space for split core current transformers. System downtimes are reduced as system parts do not have to be removed for installation.

Simply place the handy Rogowski coil quickly around power rails and circular conductors. The measuring transducer connected downstream supplies the same typical secondary currents as a standard current transformer.

Your advantages:

- High system availability due to reduced downtimes: fast installation without removing system parts
- Transform alternating currents up to 4000 A using a single measuring system
- Space saving and handy, as the current strength does not affect the size and weight of the coil
- Safe installation and operation: no dangerous open circuit voltages
- Harmonics and transients detected with phase accuracy with a large frequency spectrum from 10 to 5000 Hz
- Rogowski coil secured on power rails and circular conductors thanks to professional holding device



Detect harmonics and transients with a large frequency spectrum from 10 to 5000 Hz



Professional holding device for power rails

Current transformers for retrofitting PACT RCP

- Practical handling due to the flexible measuring coil for opening
- Universal application possibilities through 8 different current measuring ranges in one device: (0 ... 100/ ... / ... /4,000 A)
- The large bandwidth (10 ... 5,000 Hz) enables harmonics and transients to be detected
- It is not possible for dangerous open circuit voltages to occur
- The bracket ensures optimum alignment of the measuring coil to the power rail
- Low space requirement in the control cabinet



Current transformer for subsequent installation in the field

| Technical data | |
|---|--|
| Measuring coil input data | |
| Frequency range | 10 Hz ... 5000 Hz |
| Input signal | Sine |
| Position error | < 1% (the measuring coil is at right angles to the live connector.) |
| Measuring coil signal output | |
| Output signal (at 50 Hz) | 100 mV (no load, at 1,000 A) |
| General data, measuring coil | |
| Length of signal cable | 3000 mm |
| Rated insulation voltage | 1000 V AC (rms CAT III) 600 V AC (rms CAT IV) 10.45 kV (DC/1 min.) |
| Test voltage | |
| Ambient temperature (operation) | -30°C ... 80°C (measuring coil) |
| Ambient temperature (storage/transport) | -40°C ... 90°C (measuring coil) |
| Measuring transducer input data | |
| Measuring ranges (current) via DIP switch | 100 A 250 A 400 A 630 A 1000 A 1500 A 2000 A 4000 A |
| Phase angle | < 1° |
| Measuring transducer signal input | |
| Input signal (at 50 Hz) | 100 mV (1000 A) |
| Measuring transducer signal output | |
| Current output signal | 1 A AC (effective at sine) |
| Miscellaneous data for measuring transducer | |
| Nominal supply voltage | 24 V DC -20 % ... +25 % |
| Nominal supply voltage range | 19.2 V DC ... 30 V DC |
| Transmission error, maximum | ≤ 0.5% (from the range end value) |
| Linearity error | < 0.5% (from the range end value) |
| Frequency range | 45 Hz ... 65 Hz |
| Degree of protection | IP20 |
| Test voltage | 1.5 kV AC (supply/input and output) |
| Dimensions W/H/D | 22.5/70.4/85 mm |
| Ambient temperature (operation) | -20°C ... 70°C (measuring transducer) |
| Ambient temperature (storage/transport) | -25°C ... 85°C (measuring transducer) |
| General data for the set | |
| Altitude | < 2000 m |
| Permissible humidity (operation) | 5% ... 95% (non-condensing) |
| Approvals / conformities | |
| Standards/specifications | IEC 61010-1 IEC 61010-031 IEC 61010-2-031 IEC 61010-2-032 |

| Description |
|--|
| Current transformer for retrofitting , set consisting of Rogowski coil and measuring transducer, output signal: 1 A AC (effective for sine) |
| Length of measuring coil 300 mm |
| Length of measuring coil 450 mm |
| Length of measuring coil 600 mm |

| Holding device for power rail |
|-------------------------------|
| PACT RCP-CLAMP |

| Ordering data | | |
|------------------------|-----------|-------------|
| Type | Order No. | Pcs. / Pkt. |
| PACT RCP-4000A-1A-D95 | 2904921 | 1 |
| PACT RCP-4000A-1A-D140 | 2904922 | 1 |
| PACT RCP-4000A-1A-D190 | 2904923 | 1 |

| Accessories | | |
|----------------|-----------|-------------|
| Type | Order No. | Pcs. / Pkt. |
| PACT RCP-CLAMP | 2904895 | 1 |

Recommendations for the use of coil lengths and power rail dimensions

| Power rail | Dia-meter/coil length | 1 power rail per phase | 2 power rails per phase | 3 power rails per phase |
|------------|-----------------------|------------------------|-------------------------|-------------------------|
| [mm x mm] | [mm] | | | |
| 30 x 10 | 95/300 | X | X | |
| 40 x 10 | 95/300 | X | X | |
| 40 x 10 | 140/450 | | | X |
| 50 x 10 | 95/300 | X | | |
| 50 x 10 | 140/450 | | X | X |
| 60 x 10 | 95/300 | X | | |
| 60 x 10 | 140/450 | | X | X |
| 60 x 10 | 140/450 | X | X | X |
| 100 x 10 | 140/450 | X | X | |
| 100 x 10 | 190/600 | | | X |
| 120 x 10 | 140/450 | X | | |
| 120 x 10 | 190/600 | | X | X |
| 160 x 10 | 190/600 | X | X | X |

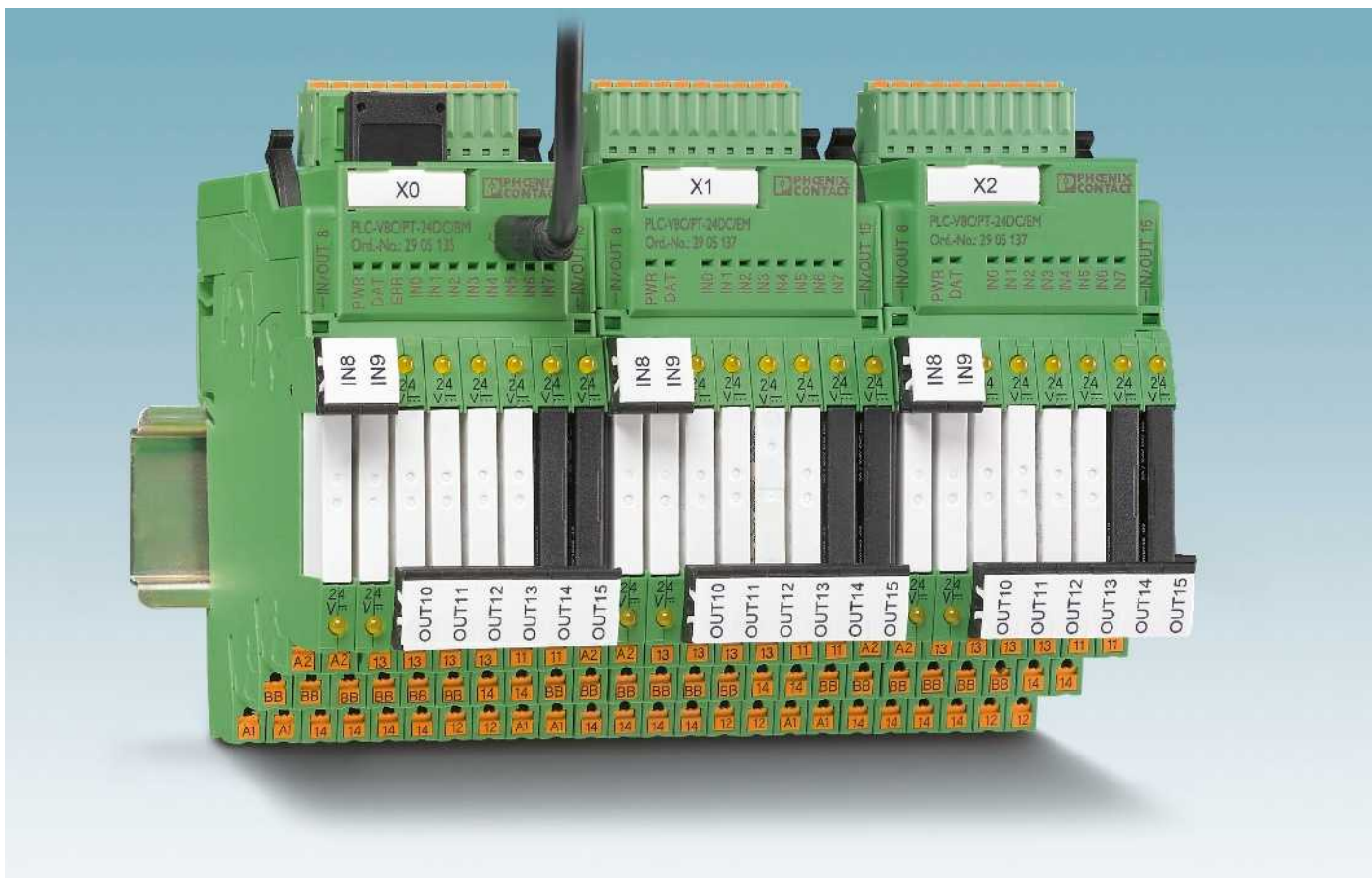

Extremely compact control

The PLC logic programmable logic relay system is the extremely compact way to carry out small automation tasks easily and flexibly. It consists of the PLC-V8C logic modules, the PLC-INTERFACE relay system, and the LOGIC+ software. The logic modules are simply plugged into a row of eight PLC-INTERFACE terminal blocks and combine the logic and interface level in one unit. Depending on the switching requirements, plug-in electromechanical and solid-state relays can be combined in order to flexibly switch and control the I/O signals.

PLC logic processes digital and analog input signals as well as logic functions and timer modules - and replaces conventional switching and control devices. Up to 16 I/O signals can be processed using the stand-alone logic modules - that's with a design width of just 50 mm. If more I/O signals are required, a maximum of 48 I/O signals can be linked using the basic and extension modules.

Switching and controlling with plug-in relays

- PLC logic brings together the standard combination of logic module and separate plug-in relay and eliminates the wiring effort and additional switching elements
- Convenient connections with screw or push-in connection technology, which also accommodate return conductors, remove the need for separate potential terminal blocks
- Each relay channel can be freely configured as an input or output. PLC logic therefore perfectly adapts to fit the application at hand

Intuitive programming

Programming is quick and easy with the intuitive LOGIC+ programming software. Ladder (LD) and function block diagrams (FBD) can be created by selecting the relevant functions and their connection using drag & drop. The graphical representation of PLC logic in the hardware editor supports intuitive operation. The programs created can be simulated offline on the PC and tested online during operation. Basic functions, such as AND, OR, NOT, etc. are complemented by special functions, such as counters, seven-day timers, timer modules, and mathematical functions, to name a few.



Logic module with plug-in relays

PLC logic combines a logic module and plug-in relay and eliminates the wiring effort and additional switching elements. Each relay channel can be flexibly equipped with an electromechanical or a solid-state relay. PLC logic processes 16 I/O signals with just one logic module and boasts an extremely compact design width of just 50 mm.



Intuitive programming with LOGIC+

- Function block diagram or ladder diagram
- Numerous integrated function blocks
- Specific function blocks are available to download
- Hardware view in the program
- Download free of charge at www.phoenixcontact.com.



Standard programming cable

PLC logic is connected to a PC via a standard micro USB cable. The drivers for PLC logic are automatically installed on connection by means of plug and play.



Easily connect extension modules

The basic module and the extension module are connected via integrated connectors - no tools required. A maximum of two extension modules can be connected to a basic module. This means that PLC logic can work with up to 48 I/Os.



Saving and copying data

PLC logic programs are saved by the memory block or can be easily copied to other devices.

If settings such as time or date are required on the new device, these values can be configured via the integrated web server. The new device does not need access to the LOGIC+ software for this.

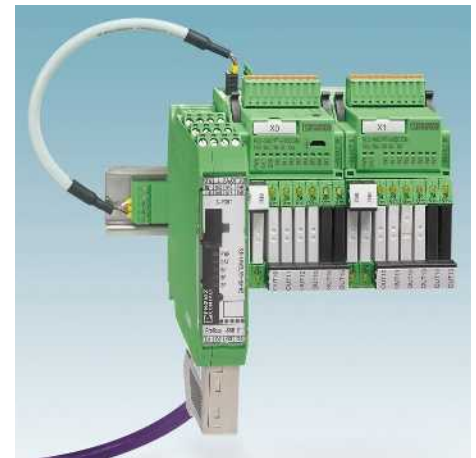

Integration into PROFIBUS DP

Adaptable fieldbus gateways, available as an option, can be used to integrate PLC logic into a PROFIBUS DP network. This enables communication with a higher-level controller for remote control, diagnostics, and visualization purposes.

DTM device drivers and GSD files for configuring the gateway can be downloaded free of charge at www.phoenixcontact.com.

Logic modules

PLC-V8C are the plug-in logic modules which form the PLC logic relay system in conjunction with the narrow 6.2 mm PLC-INTERFACE terminal blocks. Eight freely selectable PLC-INTERFACE terminal blocks must be separately ordered for each logic module. You can find an overview of matching PLC-INTERFACE terminal blocks on page 360.

All logic modules feature these properties:

- 8 integrated digital inputs (of which two inputs are configurable as analog inputs), connection via connector with screw or push-in connection technology
- A further 8 channels can be configured with matching PLC-INTERFACE terminal blocks as digital inputs or outputs
- Programming with the LOGIC+ software

PLC-V8C.../SAM

- Stand-alone logic module with 16 I/Os, not extendable
- Connection to PC via micro USB socket
- Integrated realtime clock (RTC)
- Accommodates external IFS-CONFSTICK memory block

PLC-V8C.../BM

- Basic logic module with 16 I/Os, can be extended with a maximum of two extension modules (PLC-V8C.../EM) to 48 I/Os
- Connection to PC via micro USB socket
- Integrated realtime clock (RTC)
- Accommodates external IFS-CONFSTICK memory block
- Optional connection to PROFIBUS-GATEWAY-IFS

PLC-V8C.../EM

- Extension logic module with 16 I/Os, for extending the basic module



Stand-alone module

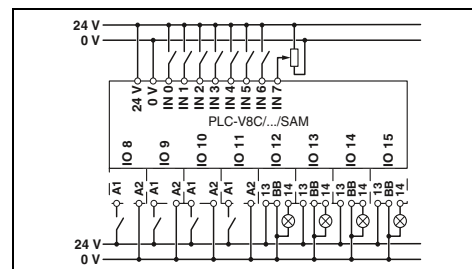

Technical data

| | |
|---|---|
| Supply | |
| Supply voltage | 24 V DC |
| Supply voltage range | 19.2 V DC ... 26.4 V DC |
| Max. input current at U_N | 120 mA |
| Input data (digital) | |
| Number of inputs | 8 (2 configurable as analog) |
| Input voltage | 24 V DC |
| Description of the input | EN 61131-2, type 3 |
| Input current 0-signal | < 1 mA |
| Input current 1-signal | Typ. 2.5 mA |
| Input data (analog) | |
| Number of inputs | 2 (IN6 and IN7 are configurable as analog) |
| Input voltage range | 0 V ... 10 V |
| Input resistance | > 4 kΩ |
| Input data (PLC-INTERFACE) | |
| Number of inputs | ≤ 8 |
| Output data (for controlling PLC-INTERFACE) | |
| Number of outputs | ≤ 8 |
| Nominal voltage | 24 V DC |
| Nominal current | 9 mA |
| Realtime clock (basic module only) | |
| Buffer time (capacitor) | 24 h (capacitor) |
| Realtime clock accuracy | ±2 s/d |
| General data | |
| Ambient temperature (operation) | -20°C ... 45°C |
| Ambient temperature (storage/transport) | -20°C ... 70°C |
| Permissible humidity (operation) | 90% |
| Air and creepage distances between the power circuits | DIN EN 50178 |
| Rated insulation voltage | 50 V |
| Rated surge voltage | 0.8 kV |
| Insulation | Basic insulation |
| Mounting type | Can be plugged onto 8 x PLC-INTERFACE |
| Degree of protection | IP20 |
| Screw connection solid/stranded/AWG | 0.14 - 1.5 mm ² /0.14 - 1.5 mm ² /28 - 16 |
| Push-in connection solid/stranded/AWG | 0.14 - 1.5 mm ² /0.14 - 1.5 mm ² /26 - 16 |

Ordering data

| Description | Type | Order No. | Pcs. / Pkt. |
|--------------------------------------|---------------------|-----------|-------------|
| PLC-V8C plug-in logic modules | | | |
| With screw connection | PLC-V8C/SC-24DC/SAM | 2905082 | 1 |
| With push-in connection | PLC-V8C/PT-24DC/SAM | 2905136 | 1 |



Basic module



Extension module

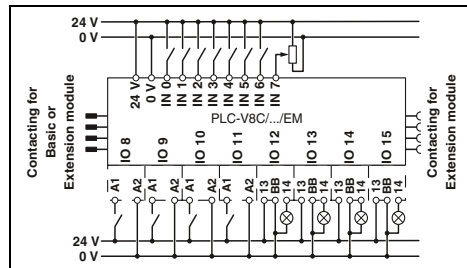
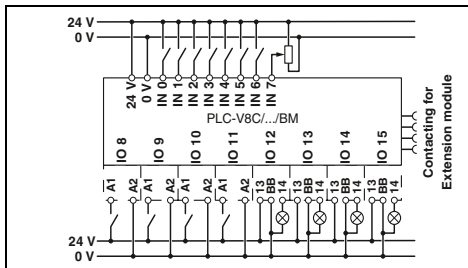

Technical data

24 V DC
19.2 V DC ... 26.4 V DC
120 mA

8 (2 configurable as analog)
24 V DC
EN 61131-2, type 3
< 1 mA
Typ. 2.5 mA

2 (IN6 and IN7 are configurable as analog)

0 V ... 10 V
> 4 kΩ

≤ 8

≤ 8
24 V DC
9 mA

24 h (capacitor)
±2 s/d

-20°C ... 45°C
-20°C ... 70°C
90%
DIN EN 50178

50 V
0.8 kV
Basic insulation
Can be plugged onto 8 x PLC-INTERFACE
IP20
0.14 - 1.5 mm²/0.14 - 1.5 mm²/28 - 16
0.14 - 1.5 mm²/0.14 - 1.5 mm²/26 - 16

Technical data

24 V DC
19.2 V DC ... 26.4 V DC
65 mA

8 (2 configurable as analog)
24 V DC
EN 61131-2, type 3
< 1 mA
Typ. 2.5 mA

2 (IN6 and IN7 are configurable as analog)

0 V ... 10 V
> 4 kΩ

≤ 8

≤ 8
24 V DC
9 mA

-

-20°C ... 45°C
-20°C ... 70°C
90%
DIN EN 50178

50 V
0.8 kV
Basic insulation
Can be plugged onto 8 x PLC-INTERFACE
IP20
0.14 - 1.5 mm²/0.14 - 1.5 mm²/28 - 16
0.14 - 1.5 mm²/0.14 - 1.5 mm²/26 - 16

Ordering data

| Type | Order No. | Pcs. / Pkt. |
|--------------------|-----------|-------------|
| PLC-V8C/SC-24DC/BM | 2903094 | 1 |
| PLC-V8C/PT-24DC/BM | 2905135 | 1 |

Ordering data

| Type | Order No. | Pcs. / Pkt. |
|--------------------|-----------|-------------|
| PLC-V8C/SC-24DC/EM | 2903095 | 1 |
| PLC-V8C/PT-24DC/EM | 2905137 | 1 |

Relay modules - PLC logic programmable logic relay system

Accessories

Programming cable and memory block

- The programming cable (MICRO USB B to USB A) is used to connect PLC logic to a PC, length: 2 m
- PLC logic programs are saved by the memory block or can be easily copied to other devices



| General data | | Technical data | | | Technical data | | |
|---|-------|----------------------------|-----------|-------------|-------------------------------|-----------|-------------|
| EMC note | | | | | Class A product, see page 443 | | |
| Description | | Ordering data | | | Ordering data | | |
| | Color | Type | Order No. | Pcs. / Pkt. | Type | Order No. | Pcs. / Pkt. |
| Programming cable | | CAB-USB A/MICRO USB B/2,0M | 2701626 | 1 | | | |
| Multi-functional memory block for the INTERFACE system | | | | | IFS-CONFSTICK | 2986122 | 1 |
| - Flat design | | | | | | | |

Accessories

Gateway to PROFIBUS DP

The gateways are connected to the PLC-V8C.../BM PLC logic basic modules via the ME 22,5 TBUS... DIN rail connector and the PLC-V8C/CAB... connecting cable.

The gateways are connected to a PC and configured via the integrated S-PORT interface and the IFS-USB-DATACABLE.

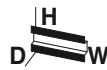

| General data | | Technical data | | | Technical data | | |
|--|-------|--------------------------------|-----------|-------------|-----------------------|-----------|-------------|
| EMC note | | Class A product, see page 443 | | | | | |
| Description | | Ordering data | | | Ordering data | | |
| | Color | Type | Order No. | Pcs. / Pkt. | Type | Order No. | Pcs. / Pkt. |
| IFS gateway for PROFIBUS DP | | EM-PB-GATEWAY-IFS | 2297620 | 1 | | | |
| Programming adapter for configuring modules with S-PORT interface Cable length: 3 m | | IFS-USB-DATACABLE | 2320500 | 1 | | | |
| DIN rail connector | | ME 22,5 TBUS 1,5/ 5-ST-3,81 GN | 2707437 | 50 | | | |
| Connecting cable for connecting PLC logic with the ME 22,5 TBUS DIN rail connector, cable length: 0.3 m | | | | | PLC-V8C/CAB/TBUS/0,3M | 2905263 | 1 |

Accessories

PLC logic starter kit

The PLC logic starter kit contains all the components needed to get started quickly and easily with PLC logic with push-in connection technology and 8 inputs and 8 outputs.

- PLC-V8C-PT/24DC/BM plug-in logic module
- PLC-RPT-24DC/1/ACT eight relay output terminal blocks
- Micro USB programming cable
- Software LOGIC+
- "PLC logic quick start guide" poster



| | | Ordering data | | |
|---|-------|------------------------------|----------------|-------------|
| Description | Color | Type | Order No. | Pcs. / Pkt. |
| PLC logic starter kit 1 , 8 integrated inputs (24 V DC) and 8 outputs via PLC-INTERFACE (switching capacity 250 V AC/DC, max. 6 A) | | PLC-LOGIC-STARTERKIT1 | 2905504 | 1 |

Dimensional drawing

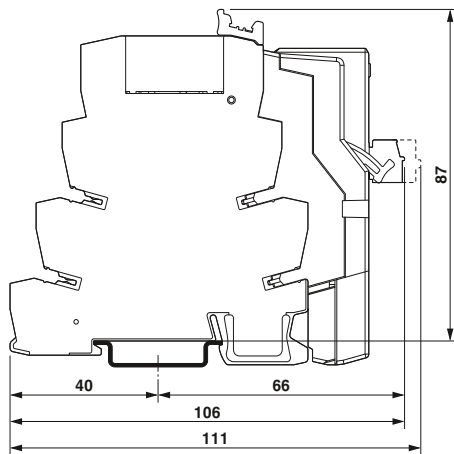

Selection table for PLC-INTERFACE

| Relay output | Push-in connection | | Screw connection | |
|--|--------------------------------|-----------|--------------------------------|-----------|
| | Type | Order No. | Type | Order No. |
| 1 PDT, output data 6 A, 250 V AC/DC | PLC-RPT-24DC/21 | 2900299 | PLC-RSC-24DC/21 | 2966171 |
| 1 PDT, output data 50 mA, 36 V DC, gold contact | PLC-RPT-24DC/21AU | 2900306 | PLC-RSC-24DC/21AU | 2966265 |
| 1 N/O contact, output data 6 A, 250 V AC/DC, actuator type | PLC-RPT-24DC/1/ACT | 2900312 | PLC-RSC-24DC/1/ACT | 2966210 |
| 1 N/O contact with switch, output data 6 A, 250 V AC/DC | PLC-RPT-24UC/1/S/H | 2900328 | PLC-RSC-24UC/1/S/H | 2982236 |
| Solid-state relay output | | | | |
| Output data 100 mA, 3 V DC - 48 V DC | PLC-OPT-24DC/48DC/100 | 2900352 | PLC-OSC-24DC/48DC/100 | 2966728 |
| Output data 3 A, 3 V DC - 33 V DC | PLC-OPT-24DC/24DC/2 | 2900364 | PLC-OSC-24DC/24DC/2 | 2966634 |
| Output data 750 mA, 24 V AC - 253 V AC | PLC-OPT-24DC/230AC/1 | 2900369 | PLC-OSC-24DC/230AC/1 | 2967840 |
| Output data 3 A, 3 V DC - 33 V DC, actuator type | PLC-OPT-24DC/24DC/2/ACT | 2900376 | PLC-OSC-24DC/24DC/2/ACT | 2966676 |
| Output data 750 mA, 24 V AC - 253 V AC, actuator type | | | PLC-OSC-24DC/230AC/1/ACT | 2967947 |
| Output data 1 A, 12 V DC - 300 V DC | PLC-OPT-24DC/300DC/1 | 2900383 | PLC-OSC-24DC/300DC/1 | 2980678 |
| Output data 10 A, 3 V DC - 33 V DC | PLC-OPT-24DC/24 DC/10/R | 2900398 | PLC-OSC-24DC/24DC/10/R | 2982702 |
| Output data 500 mA, 3 V DC - 48 V DC, electronic PDT | PLC-OPT-24DC/48DC/500/W | 2900378 | PLC-OSC-24DC/48DC/500/W | 2980636 |
| Output data, TTL, 50 mA, 5 V DC | PLC-OPT-24DC/TTL | 2900363 | PLC-OSC-24DC/TTL | 2982728 |
| Relay input | | | | |
| Input voltage 24 V DC | PLC-RPT-24DC/1AU/SEN | 2900313 | PLC-RSC-24DC/1AU/SEN | 2966317 |
| Input voltage 120 V AC/DC | PLC-RPT-120UC/1AU/SEN | 2900314 | PLC-RSC-120UC/1AU/SEN | 2966320 |
| Input voltage 230 V AC/DC | PLC-RPT-230UC/1AU/SEN | 2900315 | PLC-RSC-230UC/1AU/SEN | 2966333 |
| Input voltage 5 V DC (basic terminal block without relay) | | | PLC-BSC- 5DC/ 1/SEN | 2980267 |
| Relay for 5 V DC basic terminal block | | | REL-MR-4,5DC/21AU | 2961370 |
| Solid-state relay input | | | | |
| Input voltage 24 V DC | PLC-OPT-24DC/48DC/100/V8C/SEN | 2904693 | PLC-OSC-24DC/48DC/100/V8C/SEN | 2904690 |
| Input voltage 120 V AC/DC | PLC-OPT-120UC/48DC/100/V8C/SEN | 2904694 | PLC-OSC-120UC/48DC/100/V8C/SEN | 2904691 |
| Input voltage 230 V AC/DC | PLC-OPT-230UC/48DC/100/V8C/SEN | 2904695 | PLC-OSC-230UC/48DC/100/V8C/SEN | 2904692 |
| Dummy or reserve | | | | |
| Basic terminal block output | PLC-BPT-24DC/21 | 2900445 | PLC-BSC-24DC/21 | 2966016 |
| Basic terminal block input | PLC-BPT-24DC/1/SEN | 2900262 | PLC-BSC-24DC/1/SEN | 2966061 |

LOGIC+ programming software



Integrated web server

PLC logic basic settings are easily configured via the integrated web server. The LOGIC+ software does not need to be installed in order to do so.

- Time and date
- Password and access control
- Firmware update
- Status indicators for inputs and outputs
- General device information



LOGIC+ user interface

- Clear separation in program editor, toolbox, hardware view, and signaling window
- All elements can be easily placed using drag & drop
- Notes and errors are highlighted in color in the program editor



Hardware configurator

- Each relay channel can be configured as an input or output with an electromechanical or a solid-state relay
- Clear assignment of the inputs and outputs thanks to the graphical representation of the hardware connections

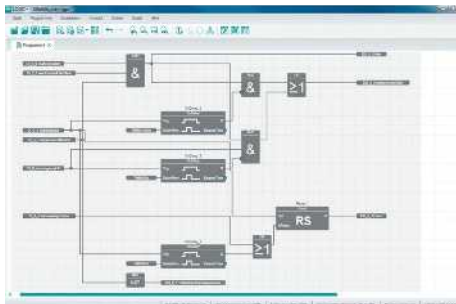

Function blocks

- Basic functions: AND, OR, NOT, XOR
- Mathematical functions: add, divide, multiply, subtract, generate absolute value
- Positive and negative edge detection
- RS and SR flip-flops
- Switch-on and switch-off delay, pulse encoder, pulse stretching, weekly clock timer
- Up and down counter
- Analog and digital comparators
- Special functions, e.g., solar altitude calculations are available for download

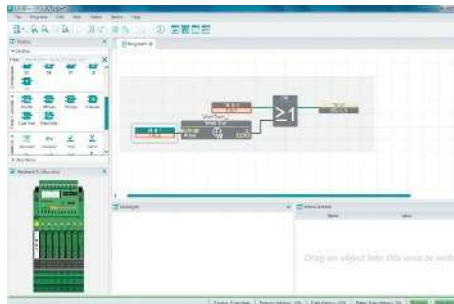

Simulation and online values

- Offline simulation:
 - Simulation of the created program directly in LOGIC+
 - Virtualization of the values in the program editor, hardware view, and in the observation window
- Online values:
 - Representation of the program running on the hardware in LOGIC+ with online values
 - Overwriting of values from LOGIC+

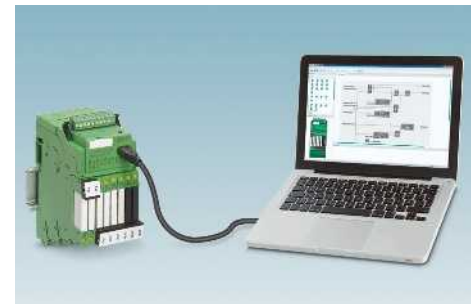

Example programs

Numerous application examples make it easy to get started with LOGIC+. These include:

- Underground garage ventilation
- Conveyor belt
- Pumping plant
- Two-way control
- Tips for creating shift registers or surge relays

Fully mounted RIF-0 relay modules

Fully mounted RIF-0 relay modules, consisting of:

- Relay base with push-in connection
- Solid-state relays
- Relay ejector lever on the housing

The advantages:

- Status LED integrated into the base
- RTIII sealed solid-state relay
- Zero voltage switch at AC output
- Professional bridging of adjacent modules saves wiring time



Max. DC voltage output of 3 A

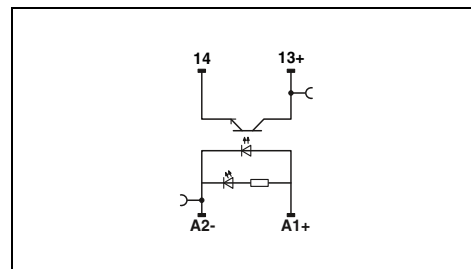

Technical data

| Input data | | ① |
|---|----------------|---|
| Rated actuating voltage range with reference to U_C | | 0.8 - 1.2 |
| Switching level (with reference to U_C) | 1 signal ("H") | > 0.8 |
| | 0 signal ("L") | < 0.4 |
| Rated actuating current I_C | [mA] | 8.5 |
| Typ. switch-on time at U_N | [ms] | 0.02 |
| Typ. switch-off time at U_N | [ms] | 0.3 |
| Transmission frequency f_{limit} | [Hz] | 300 |
| Input circuit DC | | Yellow LED, free-wheeling diode |
| Output data | | |
| Max. switching voltage | | 33 V DC |
| Min. switching voltage | | 3 V DC |
| Max. inrush current | | 15 A (10 ms) |
| Min./max. switching current | | -/3 A (see derating curve) |
| Output protection | | Protection against polarity reversal, surge protection |
| Voltage drop at max. limiting continuous current | | < 200 mV |
| Leakage current in off state | | - |
| Phase angle (cos ϕ) | | - |
| Max. load value | | - |
| General data | | |
| Test voltage input/output | | 2.5 kV _{rms} (50 Hz, 1 min.) |
| Ambient temperature (operation) | | -25°C ... 60°C |
| Standards/regulations | | DIN EN 50178 |
| Pollution degree/surge voltage category | | 2/III |
| Connection data solid/stranded/AWG | | 0.14 - 1.5 mm ² /0.14 - 1.5 mm ² /26 - 16 |
| Dimensions | W / H / D | 6.2 mm/93 mm/66 mm |
| EMC note | | Class A product, see page 443 |

Ordering data

| Description | Rated actuating voltage U_C | Type | Order No. | Pcs. / Pkt. |
|---|-------------------------------|-----------------------|-----------|-------------|
| Coupling relay modules with solid-state relay and push-in connection | ① 24 V DC | RIF-0-OPT-24DC/24DC/2 | 2905293 | 10 |

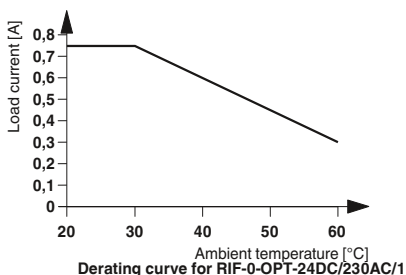
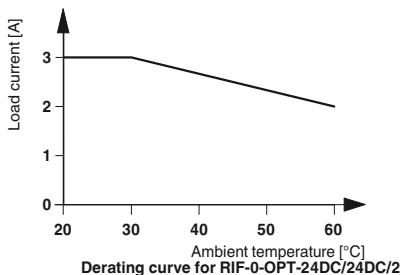

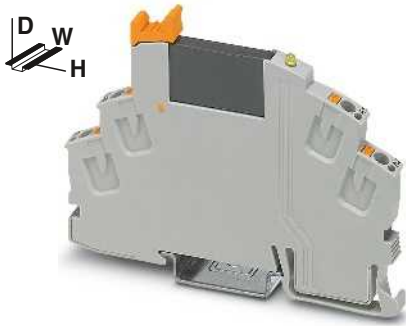

Max. DC voltage output of 100 mA



Max. AC voltage output of 750 mA

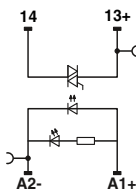
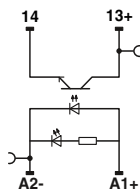

Technical data

①
 0.8 -
 1.2
 > 0.8
 < 0.4
 8.5
 0.02
 0.3
 300
 Yellow LED, free-wheeling diode

48 V DC
 3 V DC
 -
 -/100 mA
 Protection against polarity reversal, surge protection
 < 1 V
 -
 -
 -

2.5 kV_{rms} (50 Hz, 1 min.)
 -25°C ... 60°C
 DIN EN 50178
 2/III
 0.14 - 1.5 mm²/0.14 - 1.5 mm²/26 - 16
 6.2 mm/93 mm/66 mm
 Class A product, see page 443

Technical data

①
 0.8 -
 1.2
 > 0.8
 < 0.4
 8
 10
 10
 10
 10
 Yellow LED, free-wheeling diode

253 V AC
 24 V AC
 30 A (10 ms)
 10 mA/0.75 A (see derating curve)
 RCV circuit
 < 1 V
 1 mA (in off state)
 0.5
 4.5 A²s (tp = 10 ms, at 25°C)

2.5 kV_{rms} (50 Hz, 1 min.)
 -25°C ... 60°C
 DIN EN 50178
 2/III
 0.14 - 1.5 mm²/0.14 - 1.5 mm²/26 - 16
 6.2 mm/93 mm/66 mm
 Class A product, see page 443

Ordering data

| Type | Order No. | Pcs. / Pkt. |
|-------------------------|-----------|-------------|
| RIF-0-OPT-24DC/48DC/100 | 2905294 | 10 |

Ordering data

| Type | Order No. | Pcs. / Pkt. |
|------------------------|-----------|-------------|
| RIF-0-OPT-24DC/230AC/1 | 2905295 | 10 |

Relay modules - RIFLINE complete

Fully mounted RIF-1 relay modules

Fully mounted RIF-1 relay modules, consisting of:

- Relay base with push-in connection
- 1 or 2 PDT relays with detectable manual operation
- Relay retaining bracket
- Input module/interference suppr. module (AC types only)

The advantages:

- Relay with lockable manual operation and status LED
- With DC types, free-wheeling diode is integrated into relay
- Mechanical switch position indicator
- Professional bridging of adjacent modules saves wiring time

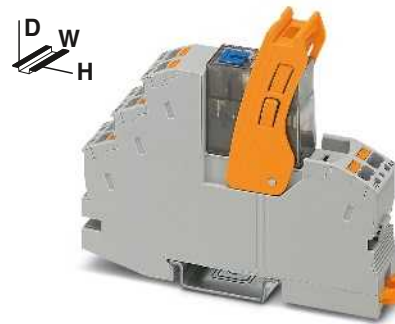

RIF-1 relay module with 1 PDT relay

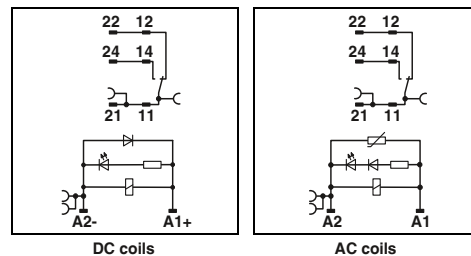

Technical data

| | ① | ② |
|--|---|--------|
| Input data | see diagram | |
| Permissible range (with reference to U_N) | 18 | 4.5 |
| Typ. input current at U_N | [mA] | 18 |
| Typ. response time at U_N | [ms] | 9 |
| Typ. release time at U_N | [ms] | 4 - 12 |
| Input circuit AC | | 10 |
| Input circuit DC | | 4 - 20 |
| Output data | Yellow LED, varistor | |
| Contact type | Yellow LED, damping diode | |
| Contact material | 1 PDT | |
| Max. switching voltage | AgNi | |
| Min. switching voltage | 250 V AC/DC | |
| Limiting continuous current | 12 V (at 10 mA) | |
| Max. inrush current | (see diagram) | |
| Min. switching current | 32 A (20 ms, N/O contact) | |
| General data | 10 mA (at 12 V) | |
| Test voltage (winding / contact) | 4 kV _{rms} (50 Hz, 1 min.) | |
| Ambient temperature (operation), AC | -40°C ... 50°C | |
| Ambient temperature (operation), DC | -40°C ... 70°C | |
| Nominal operating mode | 100% operating factor | |
| Mechanical service life | Approx. 5 x 10 ⁶ cycles | |
| Standards/regulations | DIN EN 50178, IEC 62103 | |
| Pollution degree/surge voltage category | 2/III | |
| Mounting position/mounting | Any/in rows with zero spacing | |
| Connection data solid/stranded/AWG | 0.14 - 1.5 mm ² /0.14 - 1.5 mm ² /26 - 16 | |
| Dimensions | 16 mm/93 mm/75 mm | |
| EMC note | Class A product, see page 443 | |

Ordering data

| Description | Input voltage U_N | Type | Order No. | Pcs. / Pkt. |
|---|---------------------|---------------------------|-----------|-------------|
| Coupling relay modules with power contact relay with manual operation and push-in connection | ① 24 V DC | RIF-1-RPT-LDP-24DC/1X21MS | 2905289 | 10 |
| | ② 230 V AC | RIF-1-RPT-LV-230AC/1X21MS | 2905290 | 10 |



RIF-1 relay module with 2 PDT relay

RIF-1-RPT.../1X21... (1 PDT)

Operating voltage range

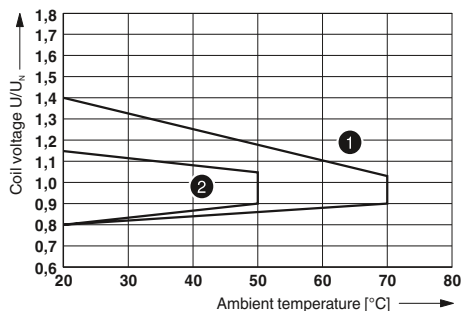

- ① DC coils
- ② AC coils

Interrupting rating

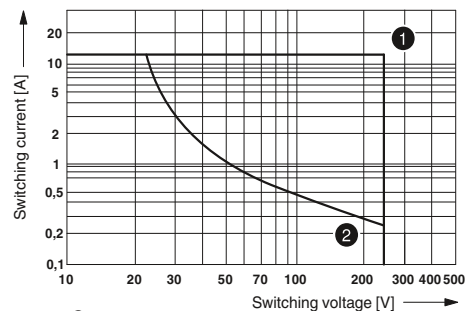

- ① = AC, ohmic load
- ② = DC, ohmic load

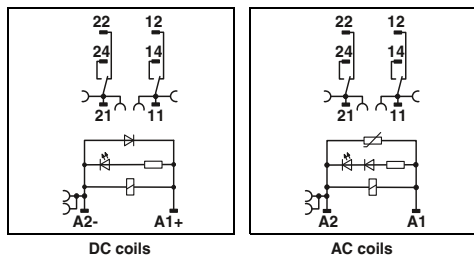

Contact derating

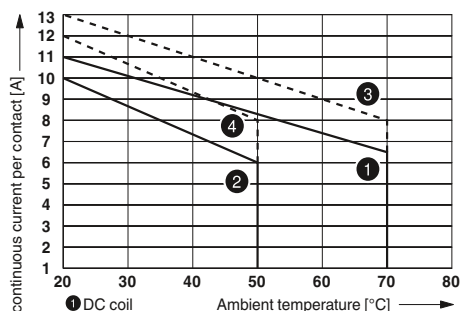

- ① DC coil
- ② AC coil
- ③ DC coil, jumper between 11 and 21
- ④ AC coil, jumper between 11 and 21

Electrical service life

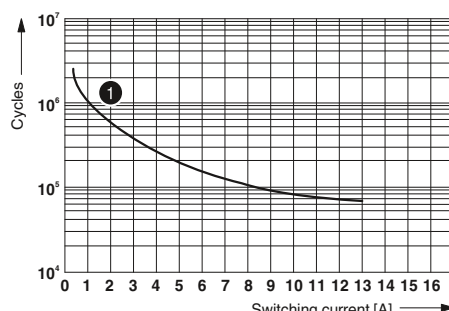

- ① = 250 V AC, ohmic load

Technical data

① ②
see diagram
18 4.5
9 4 - 12
10 4 - 20
Yellow LED, varistor
Yellow LED, damping diode

2 PDT
AgNi
250 V AC/DC
12 V (at 10 mA)
(see diagram)
16 A (20 ms, N/O contact)
10 mA (at 12 V)

4 kV_{ms} (50 Hz, 1 min.)
-40°C ... 50°C
-40°C ... 70°C
100% operating factor
Approx. 5 x 10⁶ cycles
DIN EN 50178, IEC 62103
2/III
Any/in rows with zero spacing
0.14 - 1.5 mm²/0.14 - 1.5 mm²/26 - 16
16 mm/93 mm/75 mm
Class A product, see page 443

Ordering data

| Type | Order No. | Pcs. / Pkt. |
|---------------------------|-----------|-------------|
| RIF-1-RPT-LDP-24DC/2X21MS | 2905291 | 10 |
| RIF-1-RPT-LV-230AC/2X21MS | 2905292 | 10 |

RIF-1-RPT.../2X21... (2 PDTs)

Operating voltage range

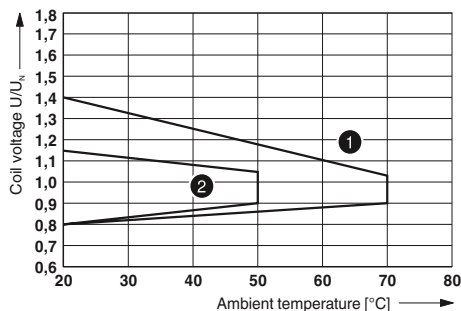

- ① DC coils
- ② AC coils

Interrupting rating

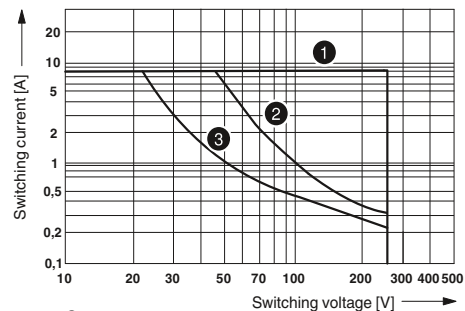

- ① AC, ohmic load
- ② DC, ohmic load, contacts in series
- ③ DC, ohmic load

Contact derating

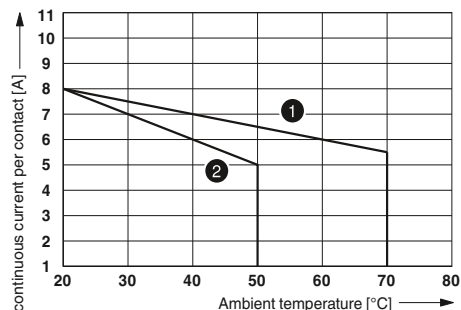

- ① DC coil
- ② AC coil

Electrical service life

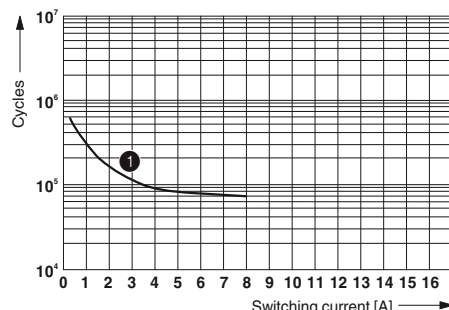

- ① 250 V AC, ohmic load

Relay modules - PLC series

PLC RELAY with an integrated solid-state relay

6.2 mm narrow solid-state relay for switching AC loads

- Status display
- Protection circuits in input and output
- Wear-free
- Switching capacity up to 230 V AC/2.4 A
- Screw and push-in connection technology



Solid-state power relay with AC voltage output of 2.4 A, max.

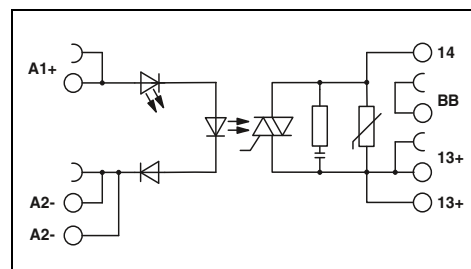

Technical data

| | |
|---|--|
| Input data | ① |
| Rated actuating voltage range with reference to U_C | 0.8 - 1.2 |
| Switching level (with reference to U_C) | 1 signal ("H") > 0.8 0 signal ("L") < 0.4 |
| Rated actuating current I_C | [mA] 8 |
| Typ. switch-on time at U_N | [ms] 10 |
| Typ. switch-off time at U_N | [ms] 10 |
| Transmission frequency f_{limit} | [Hz] 10 |
| Input circuit DC | Yellow LED, protection against polarity reversal, surge protection |
| Output data | |
| Max. switching voltage | 253 V AC |
| Min. switching voltage | 24 V AC |
| Max. inrush current | 250 A (20 ms) |
| Min./max. switching current | 10 mA/2.4 A (see derating) |
| Output protection | RCV circuit |
| Voltage drop at max. limiting continuous current | < 1 V |
| Leakage current in off state | < 1 mA |
| Phase angle (cos ϕ) | - |
| Max. load value | 340 A ² s (tp = 10 ms, at 25°C) |
| General data | |
| Rated insulation voltage | 260 V AC |
| Rated surge voltage | 4 kV |
| Insulation | Basic insulation |
| Ambient temperature (operation) | -25°C ... 60°C |
| Standards/regulations | DIN EN 50178 |
| Pollution degree/surge voltage category | 2/III |
| Connection data solid/stranded/AWG | 0.14 - 2.5 mm ² /0.14 - 2.5 mm ² /26 - 14 |
| Dimensions | 6.2 mm/80 mm/86 mm |
| EMC note | Class A product, see page 443 |

Ordering data

| Description | Rated actuating voltage U_C | Type | Order No. | Pcs. / Pkt. |
|---|-------------------------------|-----------------------------|-----------|-------------|
| PLC INTERFACE, with screw connection | | | | |
| ① | 24 V DC | PLC-OSC- 24DC/230AC/2.4/ACT | 2904631 | 10 |
| PLC-INTERFACE, with push-in connection | | | | |
| ① | 24 V DC | PLC-OPT- 24DC/230AC/2.4/ACT | 2904632 | 10 |

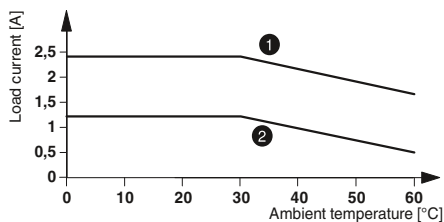

① = aligned with > 20 mm spacing
② = aligned without spacing

Load current as a function of the ambient temperature
Operating time: 100% operating factor

System cabling for controllers - VARIOFACE system cabling

VIP - power cabling

Universal front adapters for SIMATIC® S7-300

Four connection options are available:

- Connection of 40-pos. modules via four cables, each with a 10-pos. COMBI connector
- Connection of 20-pos. modules via two cables, each with a 10-pos. COMBI connector
- Connection of 40-pos. modules via 40 individual wires in rope structure (not assembled)
- Connection of 20-pos. modules via 20 individual wires in rope structure (not assembled)

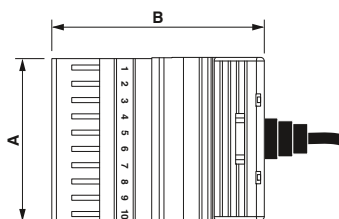

| | A | B |
|-----------------|----|----|
| ...4X10COMBI... | 52 | 70 |
| ...2X10COMBI... | | |
| ...4X10 PT... | 35 | 62 |
| ...2X10 PT... | | |



Front adapter with punched-on connectors for 40 plug-in modular terminal blocks

The front adapters have the following features:

- Can be screwed on/snapped in with the I/O module
- Suitable for all common S7-300 modules, up to max. 250 V AC/DC, 6 A
- Universal 1:1 connection
- Numerically marked wires/connectors

Combination example:

A front adapter with punched-on 10-pos. COMBI connectors can be combined with the following modular terminal blocks for field connection:

- 3045017 UT 2,5/1P
- 3210033 PT 2,5/1P
- 3040012 ST 2,5/1P
- 3040766 ST 2,5-TWIN-MT/1P

You can find further versions, accessories, and combination options in Catalog 3 “Modular terminal blocks” in the “Plug-in COMBI connection solutions” section, or online at phoenixcontact.net/products.

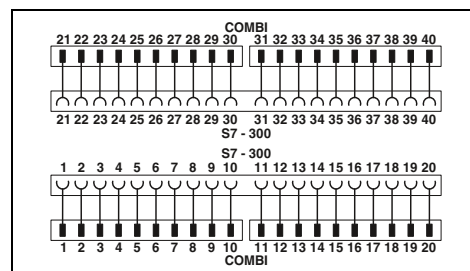

Technical data

Max. perm. operating voltage
Max. perm. current carrying capacity per path
Max. perm. total current
Rated surge voltage
Insulation
Max. conductor resistance
Conductor cross section
Conductor structure: stranded wires / material
Outside diameter
Ambient temperature range
Standards/regulations
Connection method

Front adapter
System cable

≤ 250 V AC/DC
6 A (per single wire at 40°C)
4 A (per single wire at 60°C)
20 A (per cable at 40°C)
16 A (per cable at 60°C)
4 kV
Basic insulation
39 Ω/km
AWG 21/0,5 mm²
16/Cu uninsulated
9 mm
-20°C ... 60°C
DIN EN 50178,
Can be plugged onto 40-pin I/O modules
COMBICON connectors SP-H 2,5/10

Ordering data

| Description | Cable length | Type | Order No. | Pcs. / Pkt. |
|---|--------------|-------------------------------|-----------|-------------|
| VIP - power adapter, for universal connection of the SIMATIC S7-300 | 0.5 m | VIP-PA-PWR/4X10COMBI/ 0,5M/S7 | 2904702 | 1 |
| | 1 m | VIP-PA-PWR/4X10COMBI/ 1,0M/S7 | 2904703 | 1 |
| | 1.5 m | VIP-PA-PWR/4X10COMBI/ 1,5M/S7 | 2904704 | 1 |
| | 2 m | VIP-PA-PWR/4X10COMBI/ 2,0M/S7 | 2904705 | 1 |
| | 2.5 m | VIP-PA-PWR/4X10COMBI/ 2,5M/S7 | 2904706 | 1 |
| | 3 m | VIP-PA-PWR/4X10COMBI/ 3,0M/S7 | 2904707 | 1 |
| | 4 m | VIP-PA-PWR/4X10COMBI/ 4,0M/S7 | 2904708 | 1 |
| | 5 m | VIP-PA-PWR/4X10COMBI/ 5,0M/S7 | 2904709 | 1 |
| | 6 m | VIP-PA-PWR/4X10COMBI/ 6,0M/S7 | 2904710 | 1 |
| | 8 m | VIP-PA-PWR/4X10COMBI/ 8,0M/S7 | 2904711 | 1 |
| | 10 m | VIP-PA-PWR/4X10COMBI/10,0M/S7 | 2904712 | 1 |



Front adapter with punched-on connectors for 20 plug-in modular terminal blocks



Front adapter with 40 open cable ends



Front adapter with 20 open cable ends

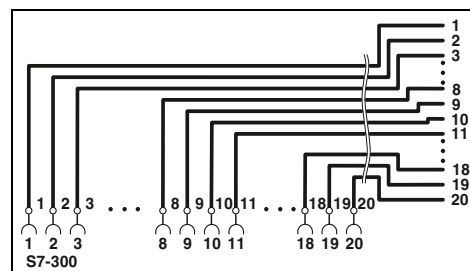
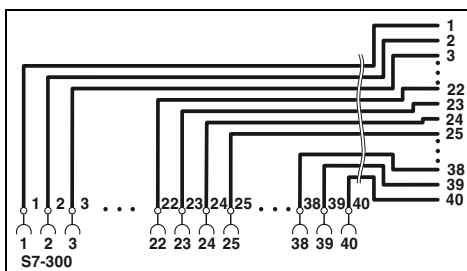
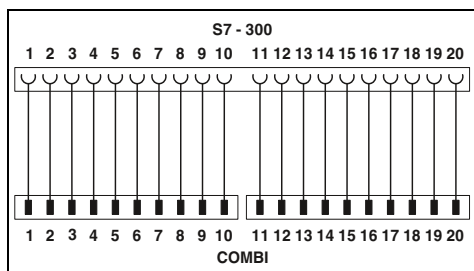

Technical data

≤ 250 V AC/DC
 6 A (per single wire at 40°C)
 4 A (per single wire at 60°C)
 20 A (per cable at 40°C)
 16 A (per cable at 60°C)
 4 kV
 Basic insulation
 39 Ω/km
 AWG 21/0.5 mm²
 16/Cu uninsulated
 9 mm
 -20°C ... 60°C
 DIN EN 50178,
 Can be plugged onto 20-pin I/O modules
 COMBICON connectors SP-H 2,5/10

Technical data

≤ 250 V AC/DC
 6 A (per single wire at 40°C)
 4 A (per single wire at 60°C)
 20 A (per cable at 40°C)
 16 A (per cable at 60°C)
 2.3 kV
 Basic insulation
 39 Ω/km
 AWG 21/0.5 mm²
 16/Cu uninsulated
 13 mm
 -20°C ... 60°C
 DIN EN 50178,
 Can be plugged onto 40-pin I/O modules
 Open cable end

Technical data

≤ 250 V AC/DC
 6 A (per single wire at 40°C)
 4 A (per single wire at 60°C)
 20 A (per cable at 40°C)
 16 A (per cable at 60°C)
 2.3 kV
 Basic insulation
 39 Ω/km
 AWG 21/0.5 mm²
 16/Cu uninsulated
 9 mm
 -20°C ... 60°C
 DIN EN 50178,
 Can be plugged onto 20-pin I/O modules
 Open cable end

Ordering data

| Type | Order No. | Pcs. / Pkt. |
|-------------------------------|-----------|-------------|
| VIP-PA-PWR/2X10COMBI/ 0,5M/S7 | 2904713 | 1 |
| VIP-PA-PWR/2X10COMBI/ 1,0M/S7 | 2904714 | 1 |
| VIP-PA-PWR/2X10COMBI/ 1,5M/S7 | 2904715 | 1 |
| VIP-PA-PWR/2X10COMBI/ 2,0M/S7 | 2904716 | 1 |
| VIP-PA-PWR/2X10COMBI/ 2,5M/S7 | 2904717 | 1 |
| VIP-PA-PWR/2X10COMBI/ 3,0M/S7 | 2904718 | 1 |
| VIP-PA-PWR/2X10COMBI/ 4,0M/S7 | 2904719 | 1 |
| VIP-PA-PWR/2X10COMBI/ 5,0M/S7 | 2904720 | 1 |
| VIP-PA-PWR/2X10COMBI/ 6,0M/S7 | 2904721 | 1 |
| VIP-PA-PWR/2X10COMBI/ 8,0M/S7 | 2904722 | 1 |
| VIP-PA-PWR/2X10COMBI/10,0M/S7 | 2904723 | 1 |

Ordering data

| Type | Order No. | Pcs. / Pkt. |
|---------------------------|-----------|-------------|
| VIP-PA-PWR/40XOE/ 1,0M/S7 | 2904731 | 1 |
| VIP-PA-PWR/40XOE/ 2,0M/S7 | 2904732 | 1 |
| VIP-PA-PWR/40XOE/ 3,0M/S7 | 2904733 | 1 |
| VIP-PA-PWR/40XOE/ 4,0M/S7 | 2904734 | 1 |
| VIP-PA-PWR/40XOE/ 6,0M/S7 | 2904735 | 1 |
| VIP-PA-PWR/40XOE/ 8,0M/S7 | 2904736 | 1 |
| VIP-PA-PWR/40XOE/10,0M/S7 | 2904737 | 1 |

Ordering data

| Type | Order No. | Pcs. / Pkt. |
|---------------------------|-----------|-------------|
| VIP-PA-PWR/20XOE/ 1,0M/S7 | 2904724 | 1 |
| VIP-PA-PWR/20XOE/ 2,0M/S7 | 2904725 | 1 |
| VIP-PA-PWR/20XOE/ 3,0M/S7 | 2904726 | 1 |
| VIP-PA-PWR/20XOE/ 4,0M/S7 | 2904727 | 1 |
| VIP-PA-PWR/20XOE/ 6,0M/S7 | 2904728 | 1 |
| VIP-PA-PWR/20XOE/ 8,0M/S7 | 2904729 | 1 |
| VIP-PA-PWR/20XOE/10,0M/S7 | 2904730 | 1 |

VIP output module

These VIP VARIOFACE output modules are used in combination with the respective front adapters. Like the front adapters, the modules are connected via 14-pos. system cables.

Features:

- Plug-in miniature relays, each with a PDT contact
- LED status display for each signal path and supply voltage
- Free-wheeling diode for each signal path
- Push-in connection



Output module with 8 miniature relays, 1 PDT and fuse per output circuit

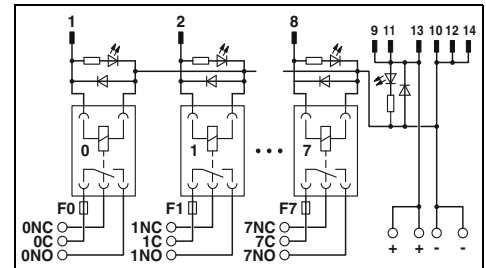

Technical data

| | | |
|------------------------------------|-------|---|
| Coil side | | |
| Operating voltage U_N | | 24 V DC |
| Typ. input current at U_N | | 9 mA |
| Typ. response time at U_N | | 5 ms |
| Typ. release time at U_N | | 8 ms |
| Input circuit | | Free-wheeling diode |
| Status display/channel | | Yellow LED |
| Connection method | | IDC/FLK pin strip (2.54 mm) |
| No. of pos. | | 14 |
| Contact side | | |
| Contact type | | Single contact, 1-PDT |
| Contact material | | AgSnO |
| Max. switching voltage | | 250 V AC/DC |
| Min. switching voltage | | 12 V AC/DC |
| Limiting continuous current | | 5 A (observe derating) |
| Min. switching current | | 10 mA |
| Max. interrupting rating: | | 24 V DC 140 W |
| | | 48 V DC 20 W |
| | | 60 V DC 18 W |
| | | 110 V DC 23 W |
| | | 220 V DC 40 W |
| | | 250 V AC 1500 VA |
| Connection method | | Push-in connection |
| Connection data solid/stranded/AWG | | 0.14 ... 2.5 mm ² /0.14 ... 2.5 mm ² /26 - 14 |
| General data | | |
| Ambient temperature (operation) | | -20°C ... 60°C |
| Nominal operating mode | | 100% operating factor |
| Mechanical service life | | 2 x 10 ⁷ cycles |
| Standards/regulations | | DIN EN 50178 |
| Mounting position | | Any |
| Mounting | | In rows with zero spacing |
| Dimensions | H / D | 109.8 mm/63 mm |
| EMC note | | Class A product, see page 443 |

Ordering data

| Description | Module width W | Type | Order No. | Pcs. / Pkt. |
|---|-------------------|----------------------------|-----------|----------------|
| VARIOFACE output module, with eight miniature relays, plugged, for 24 V DC (incl. relays) | 87.6 | VIP-8RPT-24DC/21/D0/FU/PLC | 2903601 | 1 |

VIP input module

These VIP VARIOFACE input modules are used in combination with the respective front adapters. Like the front adapters, the modules are connected via 14-pos. system cables.

Features:

- Plug-in miniature relays, each with an N/O contact
- LED status display for each signal path and supply voltage
- Free-wheeling diode for each signal path
- Push-in connection



Digital input module with 8 channels for 24 V DC



Digital input module with 8 channels for 120 V AC

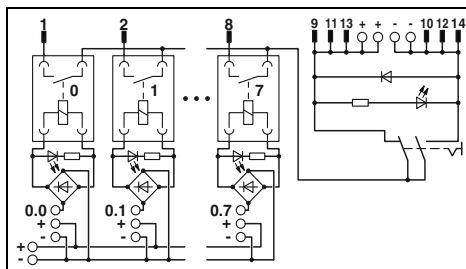

Technical data

| | |
|------------------------------------|---|
| Coil side | |
| Operating voltage U_N | 24 V DC $\pm 10\%$ (Supply, 2 A) |
| Typ. input current at U_N | 9 mA (per channel) |
| Typ. response time at U_N | 5 ms |
| Typ. release time at U_N | 8 ms |
| Input circuit | Free-wheeling diode |
| Status display/channel | Yellow LED |
| Connection method | Push-in connection |
| Connection data solid/stranded/AWG | 0.14 ... 2.5 mm ² /0.14 ... 2.5 mm ² /26 - 14 |
| Contact side | |
| Contact type | 1 N/O contact |
| Contact material | AgSnO, hard gold-plated |
| Limiting continuous current | 50 mA |
| Connection method | IDC/FLK pin strip (2.54 mm) |
| No. of pos. | 14 |
| General data | |
| Ambient temperature (operation) | -20°C ... 60°C |
| Nominal operating mode | 100% operating factor |
| Mechanical service life | 2 x 10 ⁷ cycles |
| Standards/regulations | DIN EN 50178 |
| Mounting position | Any |
| Mounting | In rows with zero spacing |
| Dimensions | 109.8 mm/63 mm |
| EMC note | Class A product, see page 443 |

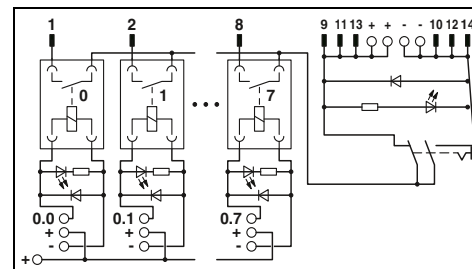

Technical data

| | |
|------------------------------------|---|
| Coil side | |
| Operating voltage U_N | 120 V AC $\pm 10\%$ (Supply, 2 A) |
| Typ. input current at U_N | 3.5 mA (per channel) |
| Typ. response time at U_N | 6 ms |
| Typ. release time at U_N | 15 ms |
| Input circuit | Free-wheeling diode |
| Status display/channel | Yellow LED |
| Connection method | Push-in connection |
| Connection data solid/stranded/AWG | 0.14 ... 2.5 mm ² /0.14 ... 2.5 mm ² /26 - 26 |
| Contact side | |
| Contact type | 1 N/O contact |
| Contact material | AgSnO, hard gold-plated |
| Limiting continuous current | 50 mA |
| Connection method | IDC/FLK pin strip (2.54 mm) |
| No. of pos. | 14 |
| General data | |
| Ambient temperature (operation) | -20°C ... 60°C |
| Nominal operating mode | 100% operating factor |
| Mechanical service life | 2 x 10 ⁷ cycles |
| Standards/regulations | DIN EN 50178 |
| Mounting position | Any |
| Mounting | In rows with zero spacing |
| Dimensions | 109.8 mm/63 mm |
| EMC note | Class A product, see page 443 |

Ordering data

| Description | Module width W |
|---|-------------------|
| VARIOFACE interface module , for eight channels, 24 V DC (incl. relays) | 92.7 |
| 120 V AC (incl. relays) | 92.7 |

| Type | Order No. | Pcs. / Pkt. |
|---------------------------------|----------------|-------------|
| VIP-8RPT-24DC/1AU/DI/PLC | 2903600 | 1 |

Ordering data

| Type | Order No. | Pcs. / Pkt. |
|----------------------------------|----------------|-------------|
| VIP-8RPT-120AC/1AU/DI/PLC | 2904576 | 1 |

Emerson DeltaV VIP controller board with fuses for 8 channels

System-specific interface module for use in combination with the respective system cables. The controller board is connected to 8-channel modules through 16-position "mass termination blocks" with flat ribbon cable connection.

Features:

- Fuse per channel
- Separate equipotential terminals per channel
- Knife disconnection for each channel
- Push-in connection

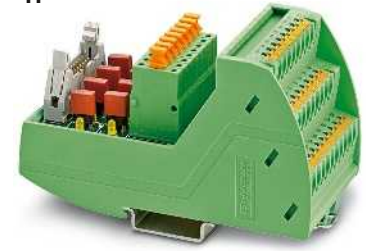

**Interface module with fuses
for 16-pos. mass termination block**

Technical data

| | |
|------------------------------------|---|
| Max. perm. operating voltage | 24 V DC |
| Max. perm. current (per branch) | 63 mA (in as supplied state, with one 63 mA fuse) |
| Ambient temperature (operation) | -20°C ... 60°C |
| Mounting position | Any |
| Standards/regulations | DIN EN 50178, |
| Connection method | Field level Push-in connection |
| | Controller level IDC/FLK pin strip (2.54 mm) |
| Connection data solid/stranded/AWG | 0.14 ... 2.5 mm ² /0.14 ... 2.5 mm ² /26 - 14 |
| Dimensions | H / D 109.8 mm/63 mm |

Ordering data

| Description | No. of pos. | Module width W | Type | Order No. | Pcs. / Pkt. |
|--|-------------|----------------|-------------------------------------|----------------|-------------|
| Interface module for 16-pos. mass termination block | 16 | 57.1 mm | VIP-PT/FLK16/DS/FU/LED/AN/DV | 2903599 | 1 |

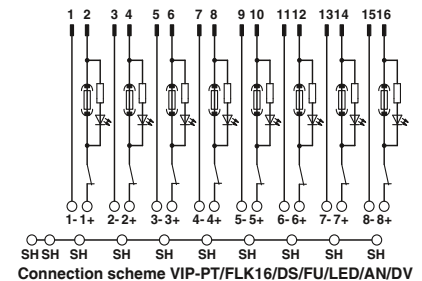

VIP potential distributor with fuses

The VIP-2/PT/PDM-2/16/FU 6.3A module has the following features:

- Two potential levels
- P1 potential has 6.3 A fusing
- Separate supply
- Consecutive labeling
- Push-in connection



Push-in connection and 2 potential levels

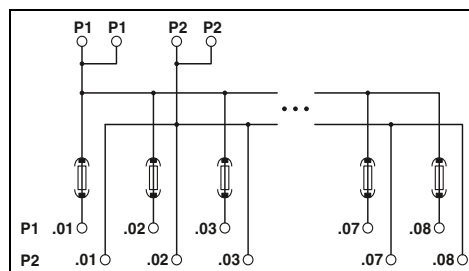

Technical data

| | |
|--|---|
| Operating voltage Max. perm. current (per branch) Total current Ambient temperature (operation) Mounting position Standards/regulations Supply connection data solid/stranded/AWG Distribution connection data solid/stranded/AWG Dimensions | 250 V AC/DC 6.3 A (fuse limited) 30 A (per potential) -20°C ... 60°C Any IEC 60664, DIN EN 50178, IEC 62103 0.2 - 10 mm ² /0.2 - 6 mm ² /24 - 8 0.14 - 2.5 mm ² /0.14 - 2.5 mm ² /26 - 14 H / D |
|--|---|

Ordering data

| Description | No. of pos. | Module width W | Type | Order No. | Pcs. / Pkt. |
|---|-------------|----------------|----------------------------------|----------------|-------------|
| VARIOFACE module with 2 busbars for potential distribution - 2 power terminal blocks/8 distributor blocks | | | VIP-2/PT/PDM-2/16/FU 6.3A | 2903603 | 1 |



Industrial Ethernet
Power over Ethernet switch Page 376
Lean Managed Switch Page 378
Smart Managed Switches Page 379
Advanced Managed Switches Page 380



Industrial Ethernet
Redundancy modules acc. to IEC 61850/IEEE 1613 Page 382
Managed Switches acc. to IEC 61850/IEEE 1613 Page 383
Media module Page 386



Industrial Ethernet
WLAN access point Page 387



Industrial communication technology
Media converters for Ethernet applications in realtime Page 388
COM server for extreme fields of application Page 390
Patch panel Page 392



Industrial communication technology
Remote signaling and remote control system Page 394



Industrial communication technology
Fast connection plugs Page 396



Industrial communication technology
Wireless system for license-free use in Europe Page 398
 Process infrastructure
Device couplers for field devices Page 399



Functional Safety
Multifunctional safety relays Page 400
 Configurable safety modules
Safe relay extension module Page 402



Functional Safety
Safe I/O modules Page 404



Functional Safety
Safe analog value processing Page 406



I/O systems — Axioline F
Bus coupler Page 408
Digital and analog input and output modules Page 410
Temperature recording modules Page 414



I/O systems — Inline
M-bus master terminal Page 416



HMIs and industrial PCs
HMIs for maritime applications Page 418



HMIs and industrial PCs
Box PCs Page 420
Panel PCs Page 422
Outdoor panel PCs Page 424
IP65 panel PCs Page 426



Software
Visualization app Page 428
Multiplexer function for retrofitting Page 429



Controllers
Standard logic modules Page 430
Programmable logic relay system Page 354

Industrial Ethernet switches

Power over Ethernet switch

Gigabit switch

The FL SWITCH 1708 M12 POE offers a unique combination of a high degree of protection, gigabit transmission, and Power over Ethernet.

The IP67 switches can be installed in a distributed manner and enable connection of Power over Ethernet devices with gigabit transmission.

Features:

- Connection via gigabit M12 plug CAT6A
- Flexible use of PoE devices thanks to powerful 30 W PoE ports (IEEE 802.3at)
- -40°C ... +70°C ambient temperature
- Gigabit support
- Jumbo frames with up to 9720 bytes
- Rugged metal housing
- IP67 protection
- Easy panel mounting

Ethernet



8 ports (M12 socket),
for wall mounting

| | |
|---|--|
| Ethernet interface | |
| Number of ports | 8 (M12 socket) |
| Transmission speed | 10/100/1000 Mbps |
| Connection method | M12 connector, 8-pos. |
| Function | |
| Basic functions | |
| Status and diagnostic indicators | |
| Network expansion parameters | |
| Cascading depth | Network, linear, and star structure: any |
| Maximum conductor length (twisted pair) | 100 m |
| Power supply | |
| Supply voltage | 24 V DC (M12 connector) |
| Residual ripple | 3.6 V _{PP} |
| Supply voltage range | 18 V DC ... 32 V DC |
| Typical current consumption | 300 mA (at U _S = 24 V DC) |
| General data | |
| Weight | 2300 g |
| Width | 176 mm |
| Height | 112 mm |
| Depth | 100 mm |
| Degree of protection | IP65/IP66/IP67 |
| Ambient temperature (operation) | -40°C ... 70°C (non-condensing) |
| Permissible humidity (operation) | 10% ... 95% |
| Noise emission | EN 61000-6-4 |
| Noise immunity | EN 61000-6-2:2005 |

Technical data

| | | |
|--|--|--|
| Technical data | | |
| Store-and-forward switch, 10/100/1000 Mbps, auto negotiation, complies with standard IEEE 802.3, 4 priority classes according to IEEE 802.1p, PoE according to IEEE 802.3at/802.3af, jumbo frames up to 9720 bytes | | |
| 3 status LEDs per Ethernet port: LINK, Activity, and PoE status. Supply voltage U _{S1} and U _{S2} (redundant supply voltage) as well as FAIL, PoE Power Status. | | |
| Ordering data | | |

| | |
|-------------|---|
| Description | Gigabit Power-over-Ethernet switch |
|-------------|---|

| Type | Order No. | Pcs. / Pkt. |
|------------------------|-----------|-------------|
| FL SWITCH 1708 M12 POE | 2701883 | 1 |

Industrial Ethernet switches

Managed switches

Lean Managed Switch

Maximum possible diagnostics in the minimum amount of space. The compact Ethernet switch is optimized for PROFINET applications in standard machine production.

The switch supports the functions required by PROFINET Class A, such as PTCP filter and Quality of Service. In addition, the Lean Managed Switch features important management functions such as a broadcast limiter, port mirroring, as well as the non-proprietary redundancy protocol RSTP.

Features:

- Compact housing
- PROFINET support
- RSTP
- PTCP filter
- Web-based management, SNMP
- Configuration can be stored externally
- Configurable alarm contact

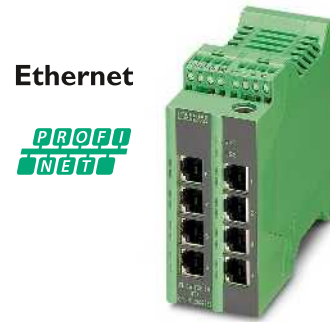

8 RJ45 ports

| Technical data | | | |
|---|--|------------------|-------------------|
| Ethernet interface | | | |
| Number of ports | 8 (RJ45 ports) | | |
| Transmission speed | 10/100 Mbps | | |
| Connection method | RJ45 | | |
| Other connections | | | |
| Serial (RS-232) | RS-232-C, 6-pos. MINI-DIN socket (PS/2) | | |
| Function | | | |
| Basic functions | Store-and-forward switch complies with IEEE 802.3 2, priority classes according to IEEE 802.1 P, TCP/IP protocol, BootP-compatible, port mirroring, integrated web server function, multicast filtering, IGMP snooping, VLAN, Rapid Spanning Tree (RSTP), DHCP server, PTCP filter | | |
| Supported browsers | Internet Explorer 5.5 or higher | | |
| SNMP – Simple Network Management Protocol | Supported SNMP-MIBs: Enterprise, MIB II, Bridge | | |
| Redundancy | Rapid Spanning Tree 802.1w, Fast Ring Detection | | |
| Status and diagnostic indicators | 2 status LEDs per Ethernet port: Link and Status Activity, 100 Mbps, full duplex, supply voltage U_{S1} and U_{S2} (redundant supply voltage) | | |
| Network expansion parameters | | | |
| Cascading depth | Network, linear, and star structure: any | | |
| Maximum conductor length (twisted pair) | 100 m | | |
| Power supply | | | |
| Supply voltage | 24 V DC | | |
| Residual ripple | 3.6 V _{PP} | | |
| Supply voltage range | 18.5 V DC ... 30.5 V DC | | |
| Typical current consumption | 250 mA (at $U_S = 24$ V DC) | | |
| General data | | | |
| Weight | 230 g | | |
| Width | 45 mm | | |
| Height | 99 mm | | |
| Depth | 112 mm | | |
| Degree of protection | IP20 | | |
| Ambient temperature (operation) | 0°C ... 55°C | | |
| Permissible humidity (operation) | 30% ... 95% (non-condensing) | | |
| EMC note | Class A product, see page 443 | | |
| Noise emission | EN 61000-6-3/-4 | | |
| Noise immunity | EN 61000-6-2:2005 | | |
| Ordering data | | | |
| Description | Type | Order No. | Pcs./ Pkt. |
| Lean Managed Switch | FL SWITCH LM 8TX-B | 2989446 | 1 |

Smart Managed Switches

The Smart Managed Narrow switch **FL SWITCH SMN 8TX-PN** is an Ethernet switch suitable for industrial applications with eight Fast Ethernet ports in RJ45 format. The switch is optimized for use in PROFINET RT and EtherNet/IP™ applications.

The switch has PROFINET mode activated by default. You can easily and quickly switch to EtherNet/IP™ or universal mode using the SMART button.

Features:

- Narrow design
- VLANs
- RSTP
- MRP client
- MRP master with FL MEM PLUG/MRM configuration memory as an option
- Web-based management, SNMP
- PROFINET device function
- LLDP

Ethernet



8 RJ45 ports

| Technical data | | |
|---|--|-------------|
| Ethernet interface | | |
| Number of ports | 8 (RJ45 ports) | |
| Transmission speed | 10/100 Mbps | |
| Connection method | RJ45 | |
| Other connections | | |
| Serial (RS-232) | RS-232-C, 6-pos. MINI-DIN socket (PS/2) | |
| Function | | |
| Basic functions | Store-and-forward switch complies with IEEE 802.3 4 priority classes in acc. with IEEE 802.1 P TCP/IP protocol, BootP-capable, port-mirroring, integrated web server function, multicast filtering, IGMP snooping, VLAN, Rapid Spanning Tree (RSTP), PROFINET Device, Media Redundancy Protocol (MRP). | |
| Status and diagnostic indicators | 2 status LEDs per Ethernet: LINK and selectable Status Activity, 100 Mbps, full duplex, supply voltage U_{S1} and U_{S2} (redundant supply voltage) and FAIL. FD/FO LED indicates duplex mode for Twisted-Pair ports and the system reserve for optical interfaces. | |
| Network expansion parameters | | |
| Cascading depth | Network, linear, and star structure: any | |
| Maximum conductor length (twisted pair) | 100 m | |
| Power supply | | |
| Supply voltage | 24 V DC | |
| Residual ripple | 3.6 V _{PP} | |
| Supply voltage range | 18 V DC ... 32 V DC | |
| Typical current consumption | 320 mA (at $U_S = 24$ V DC) | |
| General data | | |
| Weight | 720 g | |
| Width | 56 mm | |
| Height | 133 mm | |
| Depth | 125 mm | |
| Degree of protection | IP20 | |
| Ambient temperature (operation) | 0°C ... 55°C (non-condensing) | |
| Permissible humidity (operation) | 5% ... 95% (non-condensing) | |
| Noise emission | EN 61000-6-3 +A11 | |
| Noise immunity | EN 61000-6-2:2005 | |
| Ordering data | | |
| Type | Order No. | Pcs. / Pkt. |
| FL SWITCH SMN 8TX-PN | 2989501 | 1 |
| Accessories | | |
| FL MEM PLUG | 2891259 | 1 |
| FL MEM PLUG/MRM | 2891275 | 1 |
| Description | | |
| Smart Managed Narrow Switch | | |
| Configuration memory, replaceable | | |
| Configuration memory, can be replaced with MRM function | | |

Industrial Ethernet switches

Advanced Managed Switches

The automation switches in the 7000 series are the first switches to support direct integration into a Device Level Ring (DLR). Direct integration of the switches into the DLR is a considerable advantage when installing and operating EtherNet/IP™ networks.

Up to six devices can be integrated into a DLR via the FL SWITCH 7000. In system networks, the switches allow the redundant rings to be connected to the higher-level networking level. In this way, you can create networks with minimal switch-over times of less than three milliseconds (< 3 ms).

The Managed Switches of the 7000 series communicate directly via the Common Industrial Protocol (CIP) in the EtherNet/IP™ network. Via CIP, you can integrate the switch into an EtherNet/IP™ control system from where it can be configured and diagnosed.

Pure copper versions and versions with up to three fiberglass ports are available for flexible use.

Features:

- Narrow design
- -40°C ... +70°C ambient temperature
- VLANs
- Common Industrial Protocol (CIP)
- Device Level Ring (DLR)
- RSTP
- Web-based management



Ethernet



8 RJ45 ports

| Technical data | | | |
|---|---|--------------------|-------------|
| Ethernet interface | | | |
| Number of ports | 8 (RJ45 ports) | | |
| Transmission speed | 10/100 Mbps | | |
| Connection method | RJ45 | | |
| Fiber optic interface | | | |
| Number of ports | - | | |
| Transmission speed | - | | |
| Connection method | - | | |
| Transmission length | - | | |
| Fiber optic interface | | | |
| Number of ports | - | | |
| Transmission speed | - | | |
| Connection method | - | | |
| Transmission length | - | | |
| Function | | | |
| Basic functions | Store-and-forward switch complies with IEEE 802.3, 8 priority classes in acc. with IEEE 802.1 P (QoS), N:1 port mirroring, IGMP snooping, VLANs, Rapid Spanning Tree (RSTP), Large Tree Support, Fast Ring Detection (FRD), link aggregation (802.3ad), MAC-based port security, DHCP option 82, LLDP, ACD, Device Level Ring (DLR), Common Industrial Protocol (CIP) | | |
| Status and diagnostic indicators | 2 status LEDs per Ethernet: LINK and selectable status LED: activity, 100 Mbps, full duplex. Supply voltage: U _{S1} and U _{S2} (redundant supply voltage) and FAIL. EtherNet/IP™ status LED: Net, Mod | | |
| Network expansion parameters | | | |
| Cascading depth | Network, linear, and star structure: any | | |
| Maximum conductor length (twisted pair) | 100 m | | |
| Power supply | | | |
| Supply voltage | 24 V DC | | |
| Residual ripple | 3.6 V _{PP} | | |
| Supply voltage range | 12 V DC ... 60 V DC | | |
| Typical current consumption | 350 mA (at U _S = 24 V DC) | | |
| General data | | | |
| Weight | 900 g | | |
| Width | 60 mm | | |
| Height | 130 mm | | |
| Depth | 135.5 mm | | |
| Degree of protection | IP20 | | |
| Ambient temperature (operation) | -40°C ... 70°C | | |
| Permissible humidity (operation) | 10% ... 95% (non-condensing) | | |
| Noise emission | EN 61000-6-4 | | |
| Noise immunity | EN 61000-6-2:2005 | | |
| Ordering data | | | |
| Description | Type | Order No. | Pcs. / Pkt. |
| Advanced Managed Switch - 8 RJ45 ports - 6 RJ45 ports, 2 SC FO ports (multi-mode) - 5 RJ45 ports, 2 SC fiber optic ports (multi-mode), 1 SC fiber optic port (single-mode) | FL SWITCH 7008-EIP | 2701418 | 1 |
| Parameterization memory, replaceable | | Accessories | |
| | SD FLASH 512MB | 2988146 | 1 |

Ethernet



**6 RJ45 ports and
2 fiber optic ports (multi-mode)**

Ethernet



**5 RJ45 ports and
1 fiber optic port (multi-mode),
2 fiber optic ports (single-mode)**

Technical data

6 (RJ45 ports)
10/100 Mbps
RJ45

2 (SC multi-mode)
100 Mbps (full duplex)
SC
11000 m (fiberglass with F-G 62.5/125 0.7 dB/km F1000)

-
-
-
-

Store-and-forward switch complies with IEEE 802.3, 8 priority classes in acc. with IEEE 802.1 P (QoS), N:1 port mirroring, IGMP snooping, VLANs, Rapid Spanning Tree (RSTP), Large Tree Support, Fast Ring Detection (FRD), link aggregation (802.3ad), MAC-based port security, DHCP option 82, LLDP, ACD, Device Level Ring (DLR), Common Industrial Protocol (CIP)

2 status LEDs per Ethernet: LINK and selectable status LED: activity, 100 Mbps, full duplex. Supply voltage: U_{S1} and U_{S2} (redundant supply voltage) and FAIL. EtherNet/IP™ status LED: Net, Mod

Network, linear, and star structure: any
100 m

24 V DC
3.6 V_{pp}
12 V DC ... 60 V DC
470 mA (at $U_S = 24$ V DC)

990 g
60 mm
130 mm
135.5 mm
IP20
-40°C ... 70°C
10% ... 95% (non-condensing)
EN 61000-6-4
EN 61000-6-2:2005

Ordering data

| Type | Order No. | Pcs. / Pkt. |
|------------------------|-----------|-------------|
| FL SWITCH 7006/2FX-EIP | 2701419 | 1 |

Accessories

| | | |
|----------------|---------|---|
| SD FLASH 512MB | 2988146 | 1 |
|----------------|---------|---|

Technical data

5 (RJ45 ports)
10/100 Mbps
RJ45

1 (SC multi-mode)
100 Mbps (full duplex)
SC
11000 m (fiberglass with F-G 62.5/125 0.7 dB/km F1000)

2 (SC single-mode)
100 Mbps (full duplex)
SC
36000 m (fiberglass with F-G 9/125 0.36 dB/km)

Store-and-forward switch complies with IEEE 802.3, 8 priority classes in acc. with IEEE 802.1 P (QoS), N:1 port mirroring, IGMP snooping, VLANs, Rapid Spanning Tree (RSTP), Large Tree Support, Fast Ring Detection (FRD), link aggregation (802.3ad), MAC-based port security, DHCP option 82, LLDP, ACD, Device Level Ring (DLR), Common Industrial Protocol (CIP)

2 status LEDs per Ethernet: LINK and selectable status LED: activity, 100 Mbps, full duplex. Supply voltage: U_{S1} and U_{S2} (redundant supply voltage) and FAIL. EtherNet/IP™ status LED: Net, Mod

Network, linear, and star structure: any
100 m

24 V DC
3.6 V_{pp}
12 V DC ... 60 V DC
520 mA (at $U_S = 24$ V DC)

1000 g
60 mm
130 mm
135.5 mm
IP20
-40°C ... 70°C
10% ... 95% (non-condensing)
EN 61000-6-4
EN 61000-6-2:2005

Ordering data

| Type | Order No. | Pcs. / Pkt. |
|-----------------------------|-----------|-------------|
| FL SWITCH 7005/FX-2FXSM-EIP | 2701420 | 1 |

Accessories

| | | |
|----------------|---------|---|
| SD FLASH 512MB | 2988146 | 1 |
|----------------|---------|---|

Industrial Ethernet switches

Redundancy modules according to IEC 61850/IEEE 1613

Energy networks rely on particularly high fault tolerance. The new PRP redundancy modules enable parallel redundancy without switch-over time in the event of a fault. You can therefore ensure maximum availability of your network.

Interruption-free communication

- The FL RED 2000E redundancy module is equipped with the Parallel Redundancy Protocol (PRP)
- Interoperability in high-availability networks is possible, as required in the energy sector
- The system continues to operate in the case of redundancy without switch-over time

Robust design

- Developed according to the requirements of IEC 61850-3 and IEEE 1613: complies with the high requirements for network technology in this area
- Robust to withstand voltage fluctuations due to a wide input voltage range of 18 V DC ... 58 V DC
- Rugged metal housing
- -40°C ... 70°C operating temperature

Easy handling

- Design of a high-availability network without configuration
- LED indicators provide on-site information regarding the status of the network and redundancy
- Alarm signal contact indicates the status of the module and network

Ethernet

IEC 61850-3



Redundancy module

| | |
|--|--|
| Ethernet interface | |
| Number of ports | 3 (RJ45 ports) |
| Transmission speed | 10/100 Mbps |
| Transmission length | 100 m (per segment) |
| Fiber optic interface | |
| Interface | Ethernet FO |
| Number of ports | 2 |
| Transmission speed | 100 Mbps (full duplex) |
| Connection method | LC |
| Transmission length | 2 km (per segment) |
| Function | |
| Basic functions | |
| Status and diagnostic indicators | |
| LEDs: U _{S1} , U _{S2} (redundant voltage supply), link and activity per port | |
| Power supply | |
| Supply voltage | 24 V DC (redundant) 48 V DC (redundant) |
| Residual ripple | 3.6 V _{pp} |
| Supply voltage range | 18 V DC ... 58 V DC |
| Typical current consumption | 250 mA (@24 V DC) |
| General data | |
| Weight | |
| Width | 40 mm |
| Height | 100 mm |
| Depth | 109 mm |
| Degree of protection | IP20 |
| Ambient temperature (operation) | -40°C ... 70°C |
| Permissible humidity (operation) | 10% ... 95% (non-condensing) |
| Noise emission | EN 61000-6-4 |
| Noise immunity | IEC 61850-3, IEEE 1613, EN 61000-6-2: 2005 |

| Technical data | |
|--|------------------------|
| FL RED 2003E PRP | FL RED 2001E PRP 2LC |
| 3 (RJ45 ports) | 1 (RJ45 port) |
| | 10/100 Mbps |
| | 100 m (per segment) |
| - | Ethernet FO |
| - | 2 |
| - | 100 Mbps (full duplex) |
| - | LC |
| - | 2 km (per segment) |
| Ethernet redundancy module for the Parallel Redundancy Protocol | |
| LEDs: U _{S1} , U _{S2} (redundant voltage supply), link and activity per port | |
| 24 V DC (redundant) | |
| 48 V DC (redundant) | |
| 3.6 V _{pp} | |
| 18 V DC ... 58 V DC | |
| 250 mA (@24 V DC) | |
| 40 mm | |
| 100 mm | |
| 109 mm | |
| IP20 | |
| -40°C ... 70°C | |
| 10% ... 95% (non-condensing) | |
| EN 61000-6-4 | |
| IEC 61850-3, IEEE 1613, EN 61000-6-2: 2005 | |

| |
|--|
| Description |
| Redundancy module |
| - 3 RJ45 ports |
| - 1 RJ45 port, 2 LC fiber optic ports (multi-mode) |

| Ordering data | | |
|----------------------|-----------|-------------|
| Type | Order No. | Pcs. / Pkt. |
| FL RED 2003E PRP | 2701863 | 1 |
| FL RED 2001E PRP 2LC | 2701864 | 1 |

Managed Switches according to IEC 61850/IEEE 1613

Ethernet switches control Ethernet traffic and maximize uptime. Operation in extreme environments is assured with a wide temperature range and an electrical noise immunity up to four times that of normal industrial switches.

Features:

- DIN rail mounting
- Mix IEEE and Extended Ring redundancy options which provide 15 ms recovery time for hundreds of switches
- Comprehensive IEEE security and performance functions
- Unique web customization, diagnostic viewing mode and, help pages simplify maintenance
- Optional PRP redundancy modules provide 0 ms recovery times

Ethernet

IEC 61850-3



16 RJ45 ports

| | | Technical data | | |
|--|--|--|------------------------|-------------|
| | | FL SWITCH 3016E | FL SWITCH 3012E-2SFX | |
| Ethernet interface | | | | |
| Number of ports | | 16 (RJ45 ports) | 12 (RJ45 ports) | |
| Transmission speed | | 10/100 Mbps (with auto negotiation) | | |
| Fiber optic interface | | | | |
| Number of ports | | - | 2 (FO ports) | |
| Transmission speed | | - | 100 Mbps (full duplex) | |
| Connection method | | - | SFP ports | |
| Function | | Store and forward switch, Extended Ring and IEEE redundancy, Multicast control, IGMP snooping, trunking, Port and Tagging VLANs, Port and IEEE 802.1x security, SNMP V3 and Https security, SNTP, web customization, user accounts | | |
| Basic functions | | | | |
| Status and diagnostic indicators | | LEDs: U _{S1} , U _{S2} (redundant voltage supply), link and activity per port | | |
| Network expansion parameters | | | | |
| Cascading depth | | Network, linear, and star structure: any | | |
| Maximum conductor length (twisted pair) | | 100 m | | |
| Power supply | | | | |
| Supply voltage | | 24 V DC | | |
| Residual ripple | | 3.6 V _{pp} | | |
| Supply voltage range | | 12 V DC ... 48 V DC | | |
| Typical current consumption | | 312 mA (24 V DC) | | |
| General data | | | | |
| Weight | | | | |
| Width | | 66 mm | | |
| Height | | 173 mm | | |
| Depth | | 140 mm | | |
| Degree of protection | | IP20 | | |
| Ambient temperature (operation) | | -40°C ... 70°C | | |
| Permissible humidity (operation) | | 5% ... 95% (non-condensing) | | |
| EMC note | | Class A product, see page 443 | | |
| Noise emission | | EN 61000-6-4 | | |
| Noise immunity | | IEC 61850-3, IEEE 1613, EN 61000-6-2: 2005 | | |
| | | Ordering data | | |
| Description | | Type | Order No. | Pcs. / Pkt. |
| Managed switch | | | | |
| - 16 RJ45 ports | | FL SWITCH 3016E | 2891066 | 1 |
| - 12 RJ45 and 2 SFP FO ports | | FL SWITCH 3012E-2SFX | 2891067 | 1 |
| | | Accessories | | |
| Redundancy module | | | | |
| - 3 RJ45 ports | | FL RED 2003E PRP | 2701863 | 1 |
| - 1 RJ45 port, 2 LC fiber optic ports (multi-mode) | | FL RED 2001E PRP 2LC | 2701864 | 1 |

Industrial Ethernet switches

Managed Switches according to IEC 61850/IEEE 1613, 19" rack-mount

The FL SWITCH 4800E line of managed switches combines 24 ports of 10/100 Mbps device connections with four 10/100/1000 Mbps uplink ports for a total of 28 ports. Application flexibility is assured with different mixes of copper/fiber and fiber types, gigabit fiber/copper "combination" ports and modular power supplies. Operation in extreme environments is assured with a wide temperature range and an electrical noise immunity up to four times that of normal industrial switches.

Features:

- All switches have four Gigabit RJ45/SFP combination ports for supervisory or high throughput field network connections
- Flexible cabling using eight or 24 10/100 Mbps RJ45 connections with up to 16 fiber (100 Mbps) fiber connections
- Mix IEEE and Extended Ring redundancy options which provide 15 ms recovery time for hundreds of switches
- Optional PRP redundancy modules provide 0 ms recovery times
- Comprehensive IEEE security and performance functions
- Unique web customization, diagnostic viewing mode and help pages simplify maintenance
- Supports up to two modular, hot-swappable power supplies for maximum power flexibility and uptime
- Electrical noise immunity per IEC 61850-3 and IEEE 1613

Notes:
 1) Requires the installation of at least one FL SWITCH 4800E-P1 or FL SWITCH 4800E-P5 for operation.

Ethernet

IEC 61850-3



24 RJ45 ports and 4 gigabit combo (SFP or RJ45) ports

| | |
|---|--|
| Ethernet interface | |
| Number of ports | 24 (RJ45 ports) |
| Transmission speed | 10/100 Mbps |
| Ethernet (RJ45/FO combo) | |
| Interface | Ethernet (RJ45/FO combo) |
| Connection method | RJ45, shielded or SFP module (LC) |
| Note on connection method | Auto negotiation and autocrossing (RJ45 interface) |
| Fiber optic interface | |
| Number of ports | - |
| Transmission speed | - |
| Connection method | - |
| Transmission length | - |
| Function | |
| Basic functions | Store and forward switch, Extended Ring and IEEE redundancy, Multicast control, IGMP snooping, trunking, Port and Tagging VLANs, Port and IEEE 802.1x security, SNMP V3 and Https security, SNTp, web customization, user accounts |
| Status and diagnostic indicators | |
| | LEDs: U _{S1} , U _{S2} (redundant voltage supply), link and activity per port |
| Network expansion parameters | |
| Cascading depth | Network, linear, and star structure: any |
| Maximum conductor length (twisted pair) | 100 m |
| Power supply | |
| Power supply connection | From FL SWITCH 4800E-P... |
| Supply voltage | - |
| Nominal input voltage range | - |
| General data | |
| Weight | 4494 g |
| Width | 442 mm |
| Height | 44 mm |
| Depth | 375 mm |
| Degree of protection | IP20 |
| Ambient temperature (operation) | -40°C ... 70°C |
| Permissible humidity (operation) | 5% ... 95% (non-condensing) |
| Noise emission | EN 61000-6-4 |
| Noise immunity | IEC 61850-3, IEEE 1613, EN 61000-6-2: 2005 |

Technical data

| | | |
|---|--|--|
| Technical data | | |
| Ethernet interface | | |
| Number of ports | 24 (RJ45 ports) | |
| Transmission speed | 10/100 Mbps | |
| Ethernet (RJ45/FO combo) | | |
| Interface | Ethernet (RJ45/FO combo) | |
| Connection method | RJ45, shielded or SFP module (LC) | |
| Note on connection method | Auto negotiation and autocrossing (RJ45 interface) | |
| Fiber optic interface | | |
| Number of ports | - | |
| Transmission speed | - | |
| Connection method | - | |
| Transmission length | - | |
| Function | | |
| Basic functions | Store and forward switch, Extended Ring and IEEE redundancy, Multicast control, IGMP snooping, trunking, Port and Tagging VLANs, Port and IEEE 802.1x security, SNMP V3 and Https security, SNTp, web customization, user accounts | |
| Status and diagnostic indicators | | |
| | LEDs: U _{S1} , U _{S2} (redundant voltage supply), link and activity per port | |
| Network expansion parameters | | |
| Cascading depth | Network, linear, and star structure: any | |
| Maximum conductor length (twisted pair) | 100 m | |
| Power supply | | |
| Power supply connection | From FL SWITCH 4800E-P... | |
| Supply voltage | - | |
| Nominal input voltage range | - | |
| General data | | |
| Weight | 4494 g | |
| Width | 442 mm | |
| Height | 44 mm | |
| Depth | 375 mm | |
| Degree of protection | IP20 | |
| Ambient temperature (operation) | -40°C ... 70°C | |
| Permissible humidity (operation) | 5% ... 95% (non-condensing) | |
| Noise emission | EN 61000-6-4 | |
| Noise immunity | IEC 61850-3, IEEE 1613, EN 61000-6-2: 2005 | |

Ordering data

| Type | Order No. | Pcs. / Pkt. |
|-----------------------------------|-----------|-------------|
| FL SWITCH 4824E-4GC ¹⁾ | 2891072 | 1 |

Accessories

| | | |
|----------------------|---------|---|
| FL SWITCH 4800E-P1 | 2891075 | 1 |
| FL SWITCH 4800E-P5 | 2891076 | 1 |
| FL RED 2003E PRP | 2701863 | 1 |
| FL RED 2001E PRP 2LC | 2701864 | 1 |

| Description |
|--|
| Managed switch , 19-inch rack mounted - 24 RJ45 and 4 GB combo ports |
| Managed switch , 19-inch rack mounted with 8 RJ45 and 4 GB combo ports - 16 fiber optic (LC duplex) ports - 16 fiber optic (LC single-mode) ports - 16 fiber optic (SC duplex) ports - 16 fiber optic (SC single-mode) ports |
| Power supply , modular redundant - 48 V DC nominal - 230 V nominal |
| Redundancy module - 3 RJ45 ports - 1 RJ45 port, 2 LC fiber optic ports (multi-mode) |

Industrial Ethernet switches

Fiber optic interface module

Rugged, small form-factor pluggable (SFP) modules provide a variety of fiber optic interfaces. They are inserted into SFP sockets on managed switches, customizing both quantity and type of fiber used.

Features:

- Supports 100 Mbps full duplex fiber communication
- Electrical noise immunity per IEC 61850-3 and IEEE 1613
- Wide temperature range



IEC 61850-3

SFP modules for transmission ranges up to 40 km

| | | Technical data | | |
|--|--|---------------------------------|--------------------|-------------|
| Fiber optic interface | | FL SFP FX | FL SFP FX SM | |
| Number of ports | | 1 (LC multi-mode) | 1 (LC single-mode) | |
| Wavelength | | 1300 nm | | |
| Transmission length | | Typ. 2 km | Typ. 40 km | |
| Function | | SFP module as FO port | | |
| Basic functions | | via SFP slot | | |
| Power supply | | | | |
| Power supply connection | | | | |
| General data | | | | |
| Ambient temperature (operation) | | -40°C ... 85°C (non-condensing) | | |
| Permissible humidity (operation) | | 30% ... 95% (non-condensing) | | |
| | | Ordering data | | |
| Description | | Type | Order No. | Pcs. / Pkt. |
| Small form pluggable (SFP) fiber module (100 Mbps) | | | | |
| - Multi-mode (2 km) | | FL SFP FX | 2891081 | 1 |
| - Single-mode (40 km) | | FL SFP FX SM | 2891082 | 1 |

WLAN access point

The latest generation of WLAN modules offers maximum reliability, data throughput, and range.

Faster

- The new high-speed WLAN 5100 brings WLAN 802.11n to industrial applications and with it a data rate of up to 300 Mbps

Configuration

- Central cluster management enables the entire wireless network to be set up in just minutes

More reliable

- MiMo technology with three antennas for wireless communication that is more robust, faster, and covers a wider range

WLAN

**WLAN access point/client 2.4 GHz, 5 GHz
802.11 a, b, g, n
Approval for Japan**

| | Technical data |
|--|--|
| Wireless interface | |
| Wireless standard | IEEE 802.11 |
| Frequency band | 2.4 GHz/5 GHz |
| Antenna connection method | RSMA (female) |
| Number | 3 |
| Antenna | |
| Assembly instructions | Antennas not included in scope of supply |
| Ethernet ports | |
| Number | 2 |
| Connection method | RJ45 socket |
| Power supply for module electronics | |
| Supply voltage | 24 V DC |
| Connection method | Via COMBICON |
| Supply voltage range | 10 V DC ... 36 V DC |
| Supply current | 200 mA |
| Security | |
| | 802.11i WPA PSK (preshared key) WPA2 AES TKIP Supports 802.1X/RADIUS MAC filter |
| Function | |
| Operating modes | Access point/client adapter/repeater/WDS bridge |
| Basic functions | SNMP (V2/V3), CLI, WPS, DHCP, DCP, BootP, HTTP, HTTPS, Syslog, SD card, dual FW image, 1 x DI, 1 x DO, 2 x Ethernet 10/100 Mbit, auto crossover, auto negotiation, MODE button |
| Configuration | Cluster management, web-based management, WPS |
| General data | |
| Weight | 418 g |
| Width | 40 mm |
| Height | 109 mm |
| Depth | 109 mm |
| Degree of protection | IP20 |
| Ambient temperature (operation) | -25°C ... 60°C (extended temperature range on request) |
| Permissible humidity (operation) | 10% ... 95% (non-condensing) |
| Air pressure (operation) | 800 hPa ... 1080 hPa (up to 2000 m above mean sea level) |
| Shock in acc. with EN 60068-2-27/IEC 60068-2-27 | 30g |
| Vibration resistance in acc. with EN 60068-2-6/IEC 60068-2-6 | 5g |

| Ordering data | | |
|---------------|-----------|-------------|
| Type | Order No. | Pcs. / Pkt. |
| FL WLAN 5102 | 2701850 | 1 |
| Accessories | | |
| SD FLASH 2GB | 2988162 | 1 |

| Description |
|--|
| Wireless LAN Access Point - Approval for Japan |

| |
|---|
| Parameterization memory , Flash card without license |
|---|

Media converters

FL MC 2000T... media converters optimize the performance and reliability of industrial Ethernet applications and are optimized for use in extreme environments. Selectable port settings provide usability with a wider range of devices. Selectable low latency (700 ns) allows the media converter to be used in time-critical applications. Configurable link monitoring diagnostics increase network reliability.

Features:

- Optional multi-mode or single-mode SC duplex fiber optic connection at 100 Mbps
- DIP switch selectable auto negotiate or fixed port settings, data rate and half or full duplex
- DIP switch selectable store-and-forward or pass-through mode (low latency, 700 ns)
- Alarm contact provides power and link status diagnostics
- Link fault pass through (LFP) function for easy connection monitoring
- Wide operating temperature range (-40°C... 75°C)

Ethernet



Multi-mode fiberglass SC duplex or B-FOC (ST®) connection

| | |
|---|---|
| Supply | |
| Supply voltage | 12 V DC ... 48 V DC |
| Nominal current consumption | 110 mA (24 V DC) |
| FO interface | |
| Wavelength | 1310 nm |
| Transmission length Incl. 3 dB system reserve | 9.6 km (fiberglass with F-G 50/125 0.7 dB/km F1200) |
| Signal LEDs | |
| Switching output | LNK/ACT |
| Ethernet interface | |
| Connection method | RJ45 socket, shielded |
| Transmission speed | 10/100 Mbps |
| Link through | Link fault pass through |
| MDI-/MDI-X switchover | Auto-MDI(X) |
| Signal LEDs | LNK/ACT, 100 |
| General data | |
| Ambient temperature (operation) | -40°C ... 75°C |
| Test voltage | 500 V DC |
| Dimensions | 28 mm/110 mm/70 mm |

| Technical data | |
|---|---|
| Supply | |
| Supply voltage | 12 V DC ... 48 V DC |
| Nominal current consumption | 110 mA (24 V DC) |
| FO interface | |
| Wavelength | 1310 nm |
| Transmission length Incl. 3 dB system reserve | 9.6 km (fiberglass with F-G 50/125 0.7 dB/km F1200) |
| Signal LEDs | |
| Switching output | LNK/ACT |
| Ethernet interface | |
| Connection method | RJ45 socket, shielded |
| Transmission speed | 10/100 Mbps |
| Link through | Link fault pass through |
| MDI-/MDI-X switchover | Auto-MDI(X) |
| Signal LEDs | LNK/ACT, 100 |
| General data | |
| Ambient temperature (operation) | -40°C ... 75°C |
| Test voltage | 500 V DC |
| Dimensions | 28 mm/110 mm/70 mm |

| Description |
|---|
| FO converter, for converting 10/100 BASE-TX to: |
| Multi-mode fiberglass (1300 nm), SC duplex connection |
| Multi-mode fiberglass (1300 nm), B-FOC (ST®) connection |
| FO converter, for converting 10/100 BASE-TX to: |
| Single-mode fiberglass (1300 nm), SC duplex connection |
| Single-mode fiberglass (1300 nm), LC duplex connection |

| Ordering data | | |
|----------------|-----------|-------------|
| Type | Order No. | Pcs. / Pkt. |
| FL MC 2000T SC | 2891315 | 1 |
| FL MC 2000T ST | 2891316 | 1 |

Ethernet



Single-mode fiberglass
SC duplex connection

Ethernet



Single-mode fiberglass
SC duplex connection

Ethernet

IEC 61850-3



Single-mode fiberglass
LC duplex connection

| Technical data |
|--|
| 12 V DC ... 48 V DC 110 mA (24 V DC) |
| 1310 nm 20 km (fiberglass with F-G 9/125 0.3 dB/km) |
| LNK/ACT Floating relay output |
| RJ45 socket, shielded 10/100 Mbps Link fault pass through Auto-MDI(X) LNK/ACT, 100 |
| -40°C ... 75°C 500 V DC 28 mm/110 mm/70 mm |

| Technical data |
|--|
| 12 V DC ... 48 V DC 110 mA (24 V DC) |
| 1310 nm 40 km (fiberglass with F-G 9/125 0.3 dB/km) |
| LNK/ACT Floating relay output |
| RJ45 socket, shielded 10/100 Mbps Link fault pass through Auto-MDI(X) LNK/ACT, 100 |
| -40°C ... 75°C 500 V DC 28 mm/110 mm/70 mm |

| Technical data |
|---|
| 12 V DC ... 57 V DC 110 mA (24 V DC) |
| 1300 nm 40 km (typical) |
| LNK/ACT Floating relay output |
| RJ45 socket, shielded 100 Mbps Link fault pass through Auto-MDI(X) LNK/ACT, 100 |
| -40°C ... 75°C 500 V DC 30 mm/130 mm/100 mm |

| Ordering data | | |
|---------------------|-----------|-------------|
| Type | Order No. | Pcs. / Pkt. |
| FL MC 2000T SM20 SC | 2891317 | 1 |

| Ordering data | | |
|---------------------|-----------|-------------|
| Type | Order No. | Pcs. / Pkt. |
| FL MC 2000T SM40 SC | 2891318 | 1 |

| Ordering data | | |
|---------------------|-----------|-------------|
| Type | Order No. | Pcs. / Pkt. |
| FL MC 2000E SM40 LC | 2891156 | 1 |

COM server for extreme fields of application



The **FL COMSERVER...232/422/485-T** offer extended temperature and supply voltage ranges. This means that you can now integrate serial RS-232/422/485 interfaces in existing Ethernet networks, even under extreme ambient conditions. Implement functions such as cable replacement, network integration or a Modbus gateway with ease.

Both devices extend the existing FL COMSERVER product range.

- FL COMSERVER BASIC 232/422/485 (Order No.: 2313478)
- FL COMSERVER UNI 232/422/485 (Order No.: 2313452)
- FL COMSERVER WLAN 232/422/485 (Order No.: 2313559)
- FL COMSERVER PRO 232/422/485 (Order No.: 2313465)

Cable replacement

Two devices in combination tunnel serial connections via Ethernet, using either the TCP or UDP protocol.

Network integration

You can integrate automation devices such as controllers or frequency inverters into a network using corresponding programming and diagnostics software. COM diversion software creates a virtual COM port on the PC and transmits the data to the FL COMSERVER.

Modbus gateway

The integrated Modbus gateway function provided in FL COMSERVER UNI converts serial Modbus ASCII or RTU data into Modbus TCP. Naturally, the conversion process also works in the opposite direction.

Features of the T versions

- Extended temperature range -40°C to +70°C
- Supply voltage 12 ... 30 V AC/DC
- Serial interfaces: RS-232, RS-422, RS-485
- 10/100 Base-T(X) interface
- Software for virtual COM ports supplied as standard
- 3-way electrical isolation VCC // RS-232/RS-422/RS-485 // network
- Configuration via web-based management

FL COMSERVER UNI...-T

- Supports TCP, UDP, Modbus TCP/RTU/ASCII
- Can be used exactly as required on Modbus master or slave

FL COMSERVER BAS...-T

- Best-value version
- Supports TCP and UDP

| | | |
|---------------------------------|--------|-----------|
| Supply | | |
| Supply voltage | | |
| Nominal current consumption | | |
| Serial port | | |
| Interfaces | | |
| Connection method | RS-232 | |
| | RS-422 | |
| | RS-485 | |
| Data format/encoding | | |
| Data flow control/protocols | | |
| Transmission speed | | |
| Termination resistor | | |
| Ethernet interface | | |
| Connection method | | |
| Transmission speed | | |
| Transmission length | | |
| Supported protocols | | |
| Auxiliary protocols | | |
| Functions | | |
| Management | | |
| General data | | |
| Ambient temperature (operation) | | |
| Electrical isolation | | |
| Test voltage | | |
| Electromagnetic compatibility | | |
| Standards/regulations | | |
| Dimensions | | W / H / D |
| Conformance / approvals | | ATEX |

| | |
|---|--|
| Description | |
| FL COMSERVER...232/422/485 , for converting serial interfaces to Ethernet. COM port redirector software and additional software supplied as standard | |
| TCP, UDP, MODBUS, PPP | |
| TCP, UDP | |

| | |
|---|--|
| D-SUB plug , with screw connection | |
| - 9-pos., socket | |
| RS-232-D-SUB cable , length: 2 m | |
| - 9-pos. socket on 9-pos. socket | |
| - 9-pos. socket on 25-pos. socket | |
| Patch cable , CAT5, preassembled | |
| 3 m | |
| Shield connection clamp for RS-485/422 operation | |

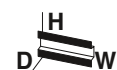

Ethernet



Universal device - Modbus gateway between RTU/ASCII and TCP



Ethernet



Basic version for redirector operation - TCP and UDP

| Technical data |
|---|
| 12 V AC/DC ... 30 V AC/DC (observe derating) 100 mA (24 V DC) |
| RS-232, RS-422, RS-485 D-SUB-9 plug Plug-in/screw connection via COMBICON Plug-in/screw connection via COMBICON UART/NRZ: 7/8 bit data, 1/2 bit stop, 1 bit parity |
| Software handshake, Xon/Xoff, or hardware handshake RTS/CTS // 3964 R compatible, Modbus RTU/ASCII |
| 0.3; 0.6; 1.2; 2.4; 4.8; 7.2; 9.6; 19.2; 38.4; 57.6; 115.2; 187.5; 230.4 kbps 390 Ω/180 Ω/390 Ω (configurable) |
| RJ45 socket, shielded 10/100 Mbps, auto negotiation ≤ 100 m (shielded twisted pair) TCP/IP, UDP, Modbus (TCP, RTU/ASCII), PPP ARP, DHCP, BOOTP, SNMP, RIP, RARP, HTTP, TFTP |
| Web-based management, SNMP, emergency exit with Telnet and serial |
| -40°C ... 70°C (free-standing, 40mm space on all sides) |
| DIN EN 50178 (VCC // Ethernet // Serial) 1.5 kV _{rms} (50 Hz, 1 min.) Conformance with EMC Directive 2004/108/EC EN 50121-4 45 mm/99 mm/116 mm |
| II 3G Ex nA IIC T4 Gc X |

| Technical data |
|--|
| 12 V AC/DC ... 30 V AC/DC (observe derating) 100 mA (24 V DC) |
| RS-232, RS-422, RS-485 D-SUB-9 plug Plug-in/screw connection via COMBICON Plug-in/screw connection via COMBICON UART/NRZ: 7/8 bit data, 1/2 bit stop, 1 bit parity |
| Software handshake, Xon/Xoff, or hardware handshake RTS/CTS // 3964 R compatible, Modbus RTU/ASCII |
| 0.3; 0.6; 1.2; 2.4; 4.8; 7.2; 9.6; 19.2; 38.4; 57.6; 115.2; 187.5; 230.4 kbps 390 Ω/180 Ω/390 Ω (configurable) |
| RJ45 socket, shielded 10/100 Mbps, auto negotiation ≤ 100 m (shielded twisted pair) TCP/IP, UDP ARP, DHCP, BOOTP, SNMP, RIP, RARP, HTTP, TFTP |
| Web-based management, SNMP, emergency exit with Telnet and serial |
| -40°C ... 70°C (free-standing, 40mm space on all sides) |
| DIN EN 50178 (VCC // Ethernet // Serial) 1.5 kV _{rms} (50 Hz, 1 min.) Conformance with EMC Directive 2004/108/EC EN 50121-4 45 mm/99 mm/116 mm |
| II 3G Ex nA IIC T4 Gc X |

| Ordering data | | |
|--------------------------------|-----------|-------------|
| Type | Order No. | Pcs. / Pkt. |
| FL COMSERVER UNI 232/422/485-T | 2904817 | 1 |

| Ordering data | | |
|--------------------------------|-----------|-------------|
| Type | Order No. | Pcs. / Pkt. |
| FL COMSERVER BAS 232/422/485-T | 2904681 | 1 |

| Accessories | | |
|---------------------------|---------|----|
| SUBCON 9/F-SH | 2761499 | 1 |
| PSM-KA9SUB9/BB/2METER | 2799474 | 1 |
| PSM-KA 9 SUB 25/BB/2METER | 2761059 | 1 |
| FL CAT5 PATCH 3,0 | 2832292 | 10 |
| ME-SAS | 2853899 | 10 |

| Accessories | | |
|---------------------------|---------|----|
| SUBCON 9/F-SH | 2761499 | 1 |
| PSM-KA9SUB9/BB/2METER | 2799474 | 1 |
| PSM-KA 9 SUB 25/BB/2METER | 2761059 | 1 |
| FL CAT5 PATCH 3,0 | 2832292 | 10 |
| ME-SAS | 2853899 | 10 |

Passive patch panel for the DIN rail

The mini patch panels provide a convenient alternative to on-site assembly of RJ45 plugs.

The cross-control-cabinet field cabling is simply connected to screw connection terminal blocks or RJ45 sockets, depending on the version selected.

The connection to the termination devices is then completed using pre-assembled RJ45 patch cables.

The new patch panels extend the product range of passive connection fields with new properties.

General features

- CAT5e
- 10/100 Mbps
- Mounted on DIN rails

FL-PP-RJ45/RJ45-B

Ethernet interface module with two RJ45 sockets as basic version with compact design and extended temperature range.

- Two RJ45 sockets
- 8-pin assignment: 1:1
- Extended temperature range -40°C to 85°C
- Narrow design W/H/D: 22.5 mm/78 mm/44 mm

FL-PP-RJ45-SCC/...

Y-splitter for transmission of two individual network connections with 10/100 Mbps via a CAT cable with eight wires.

- Spring-cage connection terminal blocks
- Option of shield contacting on DIN rail via jumpers
- For **FL-PP-.../SC041**: two RJ45 sockets, vertical
- For **FL-PP-.../SC045**: two RJ45 sockets, horizontal

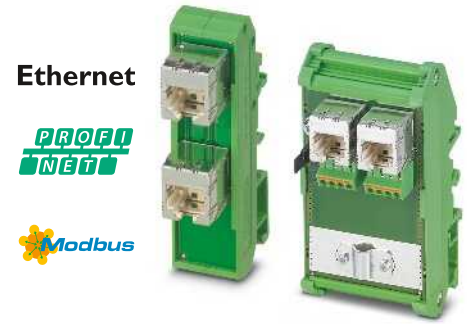

| General data | |
|-----------------------------|--|
| Cable impedance | 100 Ω |
| Transmission speed | 10/100 Mbps |
| Connection line | twisted pair, shielded, CAT5 or better |
| Transmission length | 100 m (including patch cables) |
| Plug connection | RJ45 CAT5 |
| Insertion/withdrawal cycles | ≤ 2500 |
| Degree of protection | IP20 |
| Housing material | PA 6.6-FR |
| Weight | 33 g |

| Technical data | | |
|-----------------------------|--|--|
| Cable impedance | 100 Ω | |
| Transmission speed | 10/100 Mbps | |
| Connection line | twisted pair, shielded, CAT5 or better | |
| Transmission length | 100 m (including patch cables) | |
| Plug connection | RJ45 CAT5 | |
| Insertion/withdrawal cycles | ≤ 2500 | |
| Degree of protection | IP20 | |
| Housing material | PA 6.6-FR | |
| Weight | 33 g | |

| Description | |
|---|--|
| Patch panel, two RJ45 sockets (1:1 assignment), extended temperature range , CAT5, 10/100 Mbps, DIN rail mounting, IP20, consistent shield, width 22.5 mm | |

| Ordering data | | |
|----------------------|-----------|-------------|
| Type | Order No. | Pcs. / Pkt. |
| FL-PP-RJ45/RJ45-B | 2904933 | 10 |
| FL-PP-RJ45-SCC/SC041 | 2903532 | 1 |
| FL-PP-RJ45-SCC/SC045 | 2904577 | 1 |

| Description | |
|--|--|
| Cable sharing module , two RJ45 sockets with Ethernet assignment, to 8 spring-cage connection terminal blocks, CAT5e, 10/100 Mbps, DIN rail mounting, IP20, option of shield contacting on DIN rail via jumpers | |
| - Cable outlet at the front, width 52 mm | |
| - Cable outlet at the top, width 56 mm | |

Remote signaling and remote control system

Alarm and remote control via the mobile phone network

Use the mobile phone network, monitor analog and digital values, and switch relays remotely using the TC mobile I/O product range.

Depending on the product version, data is transmitted via SMS, e-mail, GPRS or ODP protocol.

Thanks to the large voltage range and the different inputs, the signaling system is suitable for use in a wide range of applications.

Features:

- Event-controlled or continual communication
- 4 digital inputs
- 2 analog inputs (current/voltage)
- 4 relay outputs, switchable via mobile phone
- Alarming in case of voltage failure via SMS
- Configuration via USB and web browser
- Standard SIM card
- Compact design: 4 pitches (DIN 43880)
- Cover can be sealed
- Numerous helpful software functions

Applications:

- Machine, building and system monitoring
- Pumps, sewage treatment plants, water supply
- Light controllers, remote switching systems
- Lifts, doors
- Alarm and domestic engineering
- Climate and ventilation engineering
- Battery monitoring up to 60 V
- Railway applications according to EN 50121-4

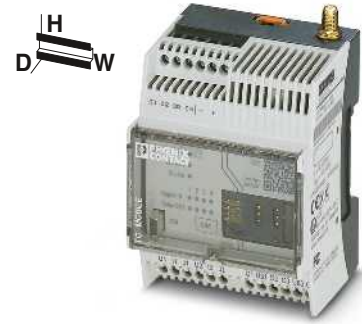

Communication via SMS and e-mail, 2 additional analog inputs

| | |
|---------------------------------|---|
| Supply | |
| Supply voltage | 10 V DC ... 60 V DC |
| Supply voltage | - |
| Nominal current consumption | 110 mA (24 V DC) |
| Stand-by current consumption | 40 mA (stand by) |
| USB interface | |
| Connection method | Mini-USB type B, 5-pos. |
| Transmission length | ≤ 3 m (only for configuration and diagnostics) |
| Mobile phone network | |
| Frequencies | 850 MHz (2 W (EGSM))/900 MHz (2 W (EGSM)) / 1800 MHz (1 W (EGSM))/1900 MHz (1 W (EGSM)) |
| Digital input | |
| Number of inputs | 4 |
| Analog input | |
| Number of inputs | 2 |
| Signal range | 0 V DC ... 60 V DC/0 mA ... 20 mA/4 mA ... 20 mA (configurable) |
| Resolution | 15 bit |
| Accuracy | ± 0.1% |
| Switching output | |
| Contact type | 4 x N/O contact |
| Max. switching voltage | 60 V |
| Limiting continuous current | 6 A |
| General data | |
| Ambient temperature (operation) | -25°C ... 70°C (for derating, see technical documentation) |
| Approvals for countries | EU, other countries in preparation |
| Electromagnetic compatibility | Conformance with EMC Directive 2004/108/EC |
| Dimensions | W / H / D 72 mm/90 mm/62 mm |
| ATEX | Ex II 3 G Ex nA nC IIC T4 Gc X |

| Technical data | | |
|---------------------------------|--|--|
| Supply | | |
| Supply voltage | | |
| Supply voltage | | |
| Nominal current consumption | | |
| Stand-by current consumption | | |
| USB interface | | |
| Connection method | | |
| Transmission length | | |
| Mobile phone network | | |
| Frequencies | | |
| Digital input | | |
| Number of inputs | | |
| Analog input | | |
| Number of inputs | | |
| Signal range | | |
| Resolution | | |
| Accuracy | | |
| Switching output | | |
| Contact type | | |
| Max. switching voltage | | |
| Limiting continuous current | | |
| General data | | |
| Ambient temperature (operation) | | |
| Approvals for countries | | |
| Electromagnetic compatibility | | |
| Dimensions | | |
| ATEX | | |

| |
|--|
| Description |
| Compact signaling system , for mobile phone networks, monitors inputs, switches relay outputs |
| - Analog and digital inputs |
| - Digital inputs |

| Ordering data | | |
|--------------------|-----------|-------------|
| Type | Order No. | Pcs. / Pkt. |
| TC MOBILE I/O X200 | 2903805 | 1 |

| |
|--|
| Multi-band antenna for UMTS and quad band GSM, with omnidirectional characteristic, 2 m antenna cable with SMA round plug, degree of protection: IP65, dimensions: 76 x 20 mm |
| Multiband antenna for external panel and external mast mounting for UMTS and quad-band GSM, with omnidirectional characteristics, 5 m antenna cable with SMA round plug |
| Antenna extension cable for UMTS and quad-band GSM, 5 m long, antenna cable with SMA plug and SMA coupling |
| Antenna extension cable for UMTS and quad-band GSM, 10 m long, antenna cable with SMA plug and SMA coupling |
| Power supply unit , primary-switched |
| USB connecting cable (individual) for configuration |
| Surge protection for UMTS and quad-band GSM antenna, with SMA plug and SMA coupling |

| Accessories | | |
|---------------------------|-----------|-------------|
| Type | Order No. | Pcs. / Pkt. |
| PSI-GSM/UMTS-QB-ANT | 2313371 | 1 |
| PSI-GSM/UMTS-ANT-OMNI-2-5 | 2900982 | 1 |
| PSI-CAB-GSM/UMTS- 5M | 2900980 | 1 |
| PSI-CAB-GSM/UMTS-10M | 2900981 | 1 |
| STEP-PS/ 1AC/24DC/0.75 | 2868635 | 1 |
| CABLE-USB/MINI-USB-3,0M | 2986135 | 1 |
| CSMA-LAMBDA/4-2.0-BS-SET | 2800491 | 1 |

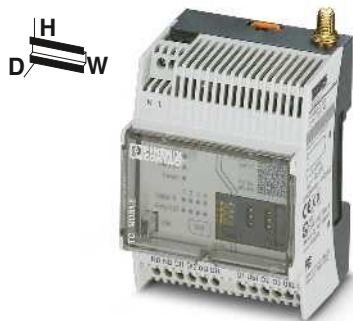

Communication via SMS and e-mail, with wide range power supply



Communication via ODP protocol, 2 additional analog inputs

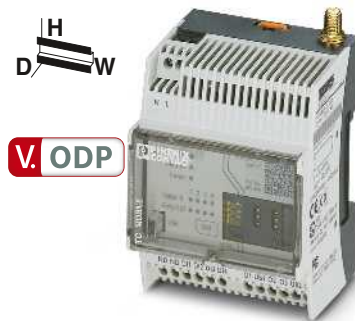

Communication via ODP protocol, with wide range power supply

| Technical data |
|---|
| - |
| 93 V AC ... 250 V AC (47.5 Hz ... 63 Hz) |
| 30 mA (230 V AC) |
| 10 mA (stand by) |
| USB 2.0 |
| Mini-USB type B, 5-pos. |
| ≤ 3 m (only for configuration and diagnostics) |
| 850 MHz (2 W (EGSM))/900 MHz (2 W (EGSM))/1800 MHz (1 W (EGSM))/1900 MHz (1 W (EGSM)) |
| 4 |
| - |
| - |
| - |
| - |
| 4 x N/O contact |
| 60 V |
| 5 A |
| -25°C ... 70°C (for derating, see technical documentation) |
| EU, other countries in preparation |
| Conformance with EMC Directive 2004/108/EC |
| 72 mm/90 mm/62 mm |
| Ex II 3 G Ex nA nC IIC T4 Gc X |

| Technical data |
|---|
| 10 V DC ... 60 V DC |
| - |
| 110 mA (24 V DC) |
| 40 mA (stand by) |
| USB 2.0 |
| Mini-USB type B, 5-pos. |
| ≤ 3 m (only for configuration and diagnostics) |
| 850 MHz (2 W (EGSM))/900 MHz (2 W (EGSM))/1800 MHz (1 W (EGSM))/1900 MHz (1 W (EGSM)) |
| 4 |
| 2 |
| 0 V DC ... 60 V DC/0 mA ... 20 mA/4 mA ... 20 mA (configurable) |
| 15 bit |
| ± 0.1% |
| 4 x N/O contact |
| 250 V AC |
| 6 A |
| -25°C ... 70°C (for derating, see technical documentation) |
| EU, other countries in preparation |
| Conformance with EMC Directive 2004/108/EC |
| 72 mm/90 mm/62 mm |
| Ex II 3 G Ex nA nC IIC T4 Gc X |

| Technical data |
|---|
| - |
| 93 V AC ... 250 V AC (48 Hz ... 62 Hz) |
| 30 mA (230 V AC) |
| 10 mA (stand by) |
| USB 2.0 |
| Mini-USB type B, 5-pos. |
| ≤ 3 m (only for configuration and diagnostics) |
| 850 MHz (2 W (EGSM))/900 MHz (2 W (EGSM))/1800 MHz (1 W (EGSM))/1900 MHz (1 W (EGSM)) |
| 4 |
| - |
| - |
| - |
| - |
| 4 x N/O contact |
| 250 V AC |
| 5 A |
| -25°C ... 70°C (for derating, see technical documentation) |
| EU, other countries in preparation |
| Conformance with EMC Directive 2004/108/EC |
| 72 mm/90 mm/62 mm |
| Ex II 3 G Ex nA nC IIC T4 Gc X |

| Ordering data | | |
|-----------------------|-----------|-------------|
| Type | Order No. | Pcs. / Pkt. |
| TC MOBILE I/O X200 AC | 2903806 | 1 |

| Ordering data | | |
|--------------------|-----------|-------------|
| Type | Order No. | Pcs. / Pkt. |
| TC MOBILE I/O X300 | 2903807 | 1 |

| Ordering data | | |
|-----------------------|-----------|-------------|
| Type | Order No. | Pcs. / Pkt. |
| TC MOBILE I/O X300 AC | 2903808 | 1 |

| Accessories | | |
|---------------------------|-----------|-------------|
| Accessories | Order No. | Pcs. / Pkt. |
| PSI-GSM/UMTS-QB-ANT | 2313371 | 1 |
| PSI-GSM/UMTS-ANT-OMNI-2-5 | 2900982 | 1 |
| PSI-CAB-GSM/UMTS- 5M | 2900980 | 1 |
| PSI-CAB-GSM/UMTS-10M | 2900981 | 1 |
| STEP-PS/ 1AC/24DC/0.75 | 2868635 | 1 |
| CABLE-USB/MINI-USB-3,0M | 2986135 | 1 |
| CSMA-LAMBDA/4-2.0-BS-SET | 2800491 | 1 |

| Accessories | | |
|---------------------------|-----------|-------------|
| Accessories | Order No. | Pcs. / Pkt. |
| PSI-GSM/UMTS-QB-ANT | 2313371 | 1 |
| PSI-GSM/UMTS-ANT-OMNI-2-5 | 2900982 | 1 |
| PSI-CAB-GSM/UMTS- 5M | 2900980 | 1 |
| PSI-CAB-GSM/UMTS-10M | 2900981 | 1 |
| STEP-PS/ 1AC/24DC/0.75 | 2868635 | 1 |
| CABLE-USB/MINI-USB-3,0M | 2986135 | 1 |
| CSMA-LAMBDA/4-2.0-BS-SET | 2800491 | 1 |

| Accessories | | |
|---------------------------|-----------|-------------|
| Accessories | Order No. | Pcs. / Pkt. |
| PSI-GSM/UMTS-QB-ANT | 2313371 | 1 |
| PSI-GSM/UMTS-ANT-OMNI-2-5 | 2900982 | 1 |
| PSI-CAB-GSM/UMTS- 5M | 2900980 | 1 |
| PSI-CAB-GSM/UMTS-10M | 2900981 | 1 |
| STEP-PS/ 1AC/24DC/0.75 | 2868635 | 1 |
| CABLE-USB/MINI-USB-3,0M | 2986135 | 1 |
| CSMA-LAMBDA/4-2.0-BS-SET | 2800491 | 1 |

**SUBCON-PLUS-M12-
fast connection**

The new SUBCON-PLUS fast connection plugs with M12 connection ensure error-free installation of bus systems, thanks to the use of fully-tested components, such as cables and connection plugs.

The innovative housing concept is lightweight yet offers optimum mechanical protection against environmental influences. This means that the fast connection plugs are ideal, even in applications subject to vibration.

The unique SPEEDCON fast locking system on the M12 connections offers reliable connection with just half a turn.

Features:

- Easy startup, plug and play
- Error-free installation, particularly in standard machine production
- Quick connection thanks to M12-SPEEDCON fast locking system
- Low weight
- Termination using M12 termination resistor
- Adapter between IP20 and IP67 environments
- For PROFIBUS and CANopen® systems

| General data | |
|---------------------------------|---|
| Cable entry | 90° (left) |
| Ambient temperature (operation) | -30°C ... 80°C |
| Degree of protection | IP40 |
| Housing material | Polyamide |
| Number of positions | 5 |
| Termination resistor | (separately via M12 termination resistor) |
| SUBCON fixing | 4-40 UNC 0.4 Nm |
| Dimensions | 16 mm/41 mm/93 mm |

| Description | |
|---|--|
| Fast connection plugs , for PROFIBUS systems, Pin assignment 3, 5, 6, 8 | |
| - Standard version | |
| Pg version with programming connection | |
| Fast connection plugs , for CAN-based systems, Pin assignment 2, 3, 5, 7, 9 | |
| - Standard version | |
| Pg version with programming connection | |

| | |
|---|--|
| PROFIBUS termination resistor | |
| - M12 pin design | |
| - M12 socket design | |
| PROFIBUS bus cable, | |
| Straight socket, shielded, M12 B-coded, 2-pos., | |
| Straight pin, shielded, M12 B-coded, 2-pos. | |
| - Cable length 1 m | |
| - Variable cable length | |
| DeviceNet™/CANopen® termination resistor | |
| - M12 pin design | |
| - M12 socket design | |
| DeviceNet™/CANopen® bus cable, | |
| Straight socket, shielded, M12 A-coded, 5-pos., | |
| Straight pin, shielded, M12 A-coded, 5-pos. | |
| - Cable length 1 m | |
| - Variable cable length | |

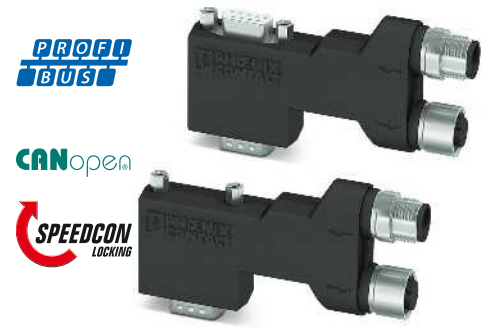

90° version, long,
suitable for Siemens S7

Technical data

| |
|---|
| 90° (left) |
| -30°C ... 80°C |
| IP40 |
| Polyamide |
| 5 |
| (separately via M12 termination resistor) |
| 4-40 UNC 0.4 Nm |
| 16 mm/41 mm/93 mm |

Ordering data

| Type | Order No. | Pcs. / Pkt. |
|-------------------------------|-----------|-------------|
| SUBCON-PLUS-PROFIB/90X/M12 | 2902729 | 1 |
| SUBCON-PLUS-PROFIB/90X/PG/M12 | 2902728 | 1 |
| SUBCON-PLUS-CAN/90X/M12 | 2902731 | 1 |
| SUBCON-PLUS-CAN/90X/PG/M12 | 2902730 | 1 |

Accessories

| | | |
|-----------------------------|---------|---|
| SAC-5P-M12MS PB TR | 1507803 | 5 |
| SAC-5P-M12FS PB TR | 1403911 | 1 |
| SAC-2P-MSB/ 1,0-910/FSB SCO | 1518122 | 1 |
| SAC-2P-MSB-FSB SCO/910/... | 1538092 | 1 |
| SAC-5P-M12MS CAN TR | 1507816 | 5 |
| SAC-5P-M12FS CAN TR | 1529344 | 5 |
| SAC-5P-MS/ 1,0-920/FS SCO | 1518274 | 1 |
| SAC-5P-MS-FS SCO/920/... | 1538157 | 1 |

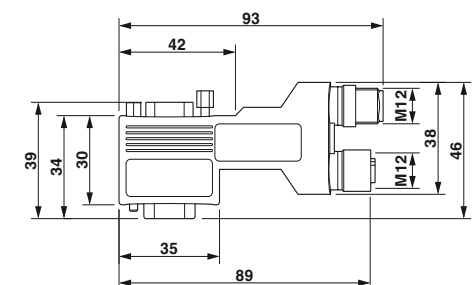

SUBCON-PLUS...90X...M12 dimensional drawing, long 90°
version

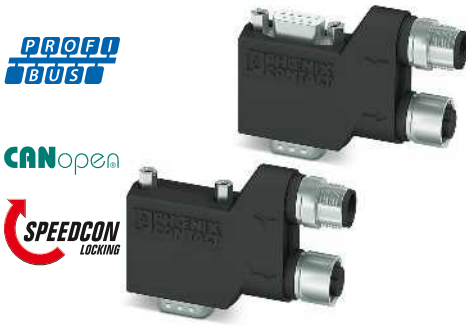

90° version, short, universal



35° version, universal

| Technical data |
|---|
| 90° (left) |
| -30°C ... 80°C |
| IP40 |
| Polyamide |
| 5 |
| (separately via M12 termination resistor) |
| 4-40 UNC 0.4 Nm |
| 16 mm/41 mm/72 mm |

| Technical data |
|---|
| 35° (left) |
| -30°C ... 80°C |
| IP40 |
| Polyamide |
| 5 |
| (separately via M12 termination resistor) |
| 4-40 UNC 0.4 Nm |
| 16 mm/48 mm /80 mm |

| Ordering data | | |
|------------------------------|-----------|-------------|
| Type | Order No. | Pcs. / Pkt. |
| SUBCON-PLUS-PROFIB/90/M12 | 2902318 | 1 |
| SUBCON-PLUS-PROFIB/90/PG/M12 | 2902317 | 1 |
| SUBCON-PLUS-CAN/90/M12 | 2902323 | 1 |
| SUBCON-PLUS-CAN/90/PG/M12 | 2902322 | 1 |

| Ordering data | | |
|------------------------------|-----------|-------------|
| Type | Order No. | Pcs. / Pkt. |
| SUBCON-PLUS-PROFIB/35/M12 | 2902320 | 1 |
| SUBCON-PLUS-PROFIB/35/PG/M12 | 2902319 | 1 |
| SUBCON-PLUS-CAN/35/M12 | 2902325 | 1 |
| SUBCON-PLUS-CAN/35/PG/M12 | 2902324 | 1 |

| Accessories | | |
|-----------------------------|---------|---|
| SAC-5P-M12MS PB TR | 1507803 | 5 |
| SAC-5P-M12FS PB TR | 1403911 | 1 |
| SAC-2P-MSB/ 1,0-910/FSB SCO | 1518122 | 1 |
| SAC-2P-MSB-FSB SCO/910/... | 1538092 | 1 |
| SAC-5P-M12MS CAN TR | 1507816 | 5 |
| SAC-5P-M12FS CAN TR | 1529344 | 5 |
| SAC-5P-MS/ 1,0-920/FS SCO | 1518274 | 1 |
| SAC-5P-MS-FS SCO/920/... | 1538157 | 1 |

| Accessories | | |
|-----------------------------|---------|---|
| SAC-5P-M12MS PB TR | 1507803 | 5 |
| SAC-5P-M12FS PB TR | 1403911 | 1 |
| SAC-2P-MSB/ 1,0-910/FSB SCO | 1518122 | 1 |
| SAC-2P-MSB-FSB SCO/910/... | 1538092 | 1 |
| SAC-5P-M12MS CAN TR | 1507816 | 5 |
| SAC-5P-M12FS CAN TR | 1529344 | 5 |
| SAC-5P-MS/ 1,0-920/FS SCO | 1518274 | 1 |
| SAC-5P-MS-FS SCO/920/... | 1538157 | 1 |

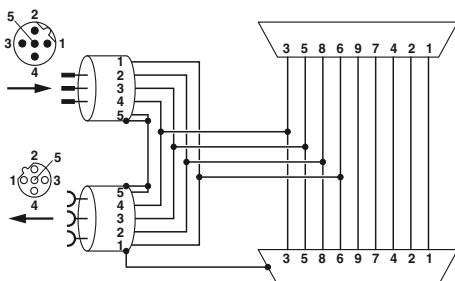

SUBCON-PLUS-PROFIB/...M12 function block diagram

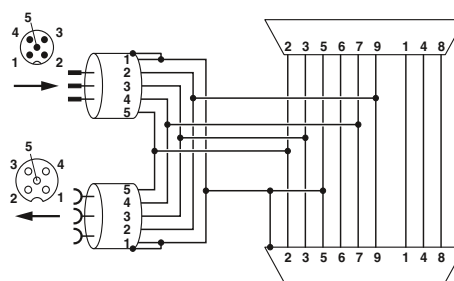

SUBCON-PLUS-CAN/...M12 function block diagram

Wireless system for license-free use in Europe

The RAD-868-IFS wireless module is suitable for license-free use in Europe.

Features:

- Trusted Wireless 2.0 wireless technology
- 868 MHz frequency band
- Adjustable transmission power up to 500 mW
- Range of up to several kilometers
- Integrated RS-232 and RS-485 interface
- Distribute signals at the turn of a switch (I/O mapping)
- Can be easily extended with up to 32 I/O extension modules via T-connector
- Optionally transmits I/O signals or serial data



868 MHz wireless transceiver, can be extended with I/O extension modules

Housing width 17.5 mm

| | |
|--|---|
| Wireless path | |
| Direction | Bi-directional |
| Frequency range | 869.4 MHz ... 869.65 MHz |
| Transmission power | ≤ 500 mW (default setting, adjustable) |
| Security | 128-bit data encryption |
| Connection method | RSMA (female) |
| Serial port | |
| Connection method | RS-232 COMBICON plug-in screw terminal block |
| Serial transmission speed | 0.3 ... 115.2 kbit/s |
| Termination resistor (switchable via DIP switches) | - |
| Analog output | |
| Signal range | RSSI voltage output 0 V ... 3 V |
| Digital output | |
| Contact type | RF link relay output PDT |
| Switching voltage | 30 V AC/60 V DC |
| Switching current | 500 mA |
| General data | |
| Supply voltage | 19.2 V DC ... 30.5 V DC |
| Degree of protection | IP20 |
| Ambient temperature range | -40°C ... 70°C |
| Permissible humidity (operation) | 20% ... 85% |
| Housing material | PA 6.6-FR |
| Dimensions W / H / D | 17.5/99/114.5 mm |
| Screw connection solid / stranded / AWG | 0.2 ... 2.5 mm ² /0.2 ... 2.5 mm ² /24 - 14 |
| Conformance / approvals | |
| Conformance | CE compliance (R&TTE directive 1999/5/EC) |
| ATEX | Ex II 3 G Ex nA nC IIC T4 Gc X |

Technical data

| | |
|---------------------------------------|--|
| RS-232 | |
| COMBICON plug-in screw terminal block | |
| 0.3 ... 115.2 kbit/s | |
| - | |
| RS-485 | |
| COMBICON plug-in screw terminal block | |
| 0.3 ... 187.5 kbit/s | |
| 390 Ω/150 Ω/390 Ω | |

| | |
|-----------------------------|--|
| RSSI voltage output | |
| 0 V ... 3 V | |
| RF link relay output | |
| PDT | |
| 30 V AC/60 V DC | |
| 500 mA | |

| | |
|---|--|
| Supply voltage | |
| 19.2 V DC ... 30.5 V DC | |
| Degree of protection | |
| IP20 | |
| Ambient temperature range | |
| -40°C ... 70°C | |
| Permissible humidity (operation) | |
| 20% ... 85% | |
| Housing material | |
| PA 6.6-FR | |
| Dimensions W / H / D | |
| 17.5/99/114.5 mm | |
| Screw connection solid / stranded / AWG | |
| 0.2 ... 2.5 mm ² /0.2 ... 2.5 mm ² /24 - 14 | |

CE compliance (R&TTE directive 1999/5/EC)
Ex II 3 G Ex nA nC IIC T4 Gc X

Ordering data

| |
|------------------------|
| Description |
| Wireless module |

| Type | Order No. | Pcs. / Pkt. |
|--------------------|----------------|-------------|
| RAD-868-IFS | 2904909 | 1 |

Accessories

| |
|---|
| Memory stick , for saving custom configuration data |
| USB cable , for diagnostics and extended configuration |

| | | |
|----------------------|----------------|---|
| RAD-MEMORY | 2902828 | 1 |
| RAD-CABLE-USB | 2903447 | 1 |

Device couplers for field devices

- Couple field devices and provide short-circuit current limiting
- Provide non-sparking and FISCO ic spur connections
- Single-sided connection configuration simplifies wiring in field housing
- Diagnostic LEDs indicate DC OK and errors at the spur connection
- Fulfills the requirements of EN 60079-0:2012, EN 60079-11:2012, EN 60079-15:2005, and EN 60079-15:2010.



Device couplers for 6 and 12 spurs

Ex:

| Technical data | |
|--|--|
| Supply | FB-6SP FB-12SP |
| Supply voltage range | 10.5 V DC ... 32 V DC (input on trunk line side) |
| Rated current | ≤ 2 A |
| Nominal current consumption | 4.8 mA 6.5 mA |
| Fieldbus interface | |
| Rated voltage | ≤ 32 V (each spur) ≤ 32 V (each spur) |
| Rated current | 38 mA 38 mA |
| Termination resistor | 100 Ω, external removable plug included |
| General data | FB-6SP FB-12SP |
| Screw connection solid / stranded / AWG | 0.2 - 2.5 mm ² /0.2 - 2.5 mm ² /24 - 12 |
| Weight | 240 g 395 g |
| Dimensions | W / H / D 148.2 mm/112.5 mm/83.5 mm 254.1 mm/112.5 mm/83.5 mm |
| Degree of protection | IP20 |
| Ambient temperature (operation) | -50°C ... 90°C |
| Max. permissible relative humidity (operation) | < 95% (non-condensing) |
| Conformance / approvals | |
| NE | NE21 |
| ATEX | Sira 13ATEX4247X; Ex nA [ic] IIC T4 Gc, Entity/FISCO ic spurs Ex nA [nL] IIC T4 Gc; Ex nA [ic] IIC T4 Gc, Entity/FISCO ic spurs; Ex nA [nL] IIC T4 Gc; Ex ic IIC T4 Gc, FISCO ic |
| IECEX | SIR 08.0110X; Ex nA [ic] IIC T4 Gc, Entity/FISCO ic spurs; Ex nA [nL] IIC T4 Gc; Ex ic IIC T4 Gc, FISCO ic |
| CSA, USA/Canada | Class I, Div. 2, Groups A, B, C, D; Ex nA [nL] IIC T4; Class I, Zone 2, AEx nA [nC] IIC T4 |
| Fieldbus Foundation | FF-846 |

| Ordering data | | | |
|---|---------|-----------|-------------|
| Description | Type | Order No. | Pcs. / Pkt. |
| Device coupler, for Foundation Fieldbus and PROFIBUS PA | | | |
| - 6 spurs | FB-6SP | 2316307 | 1 |
| - 12 spurs | FB-12SP | 2316310 | 1 |

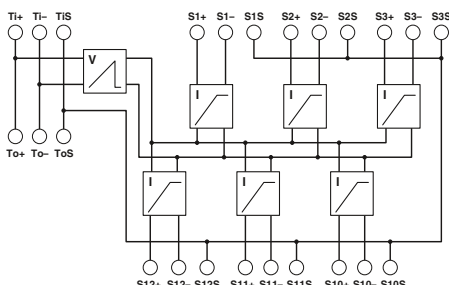

Connection diagram: FB-6SP

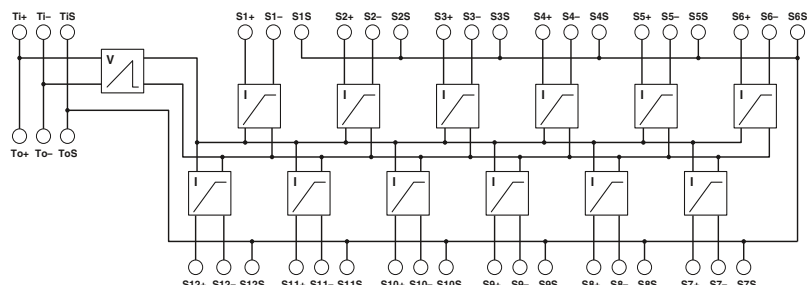

Connection diagram: FB-12SP

Functional Safety - safety switching devices

Multifunctional safety relays

You can easily implement three safety functions, such as emergency stop, safety door or light grid monitoring, with the PSR-MXF device range – and all using a single device.

In total, there are four function versions available each with three connection methods.

Features:

- Up to cat. 4/PL e according to EN ISO 13849-1
- Up to SIL 3 according to IEC 61508
- Up to SILCL 3 according to EN 62061
- Low housing width of only 22.5mm
- No software configuration required



Screw connection



Spring-cage connection

△ FS

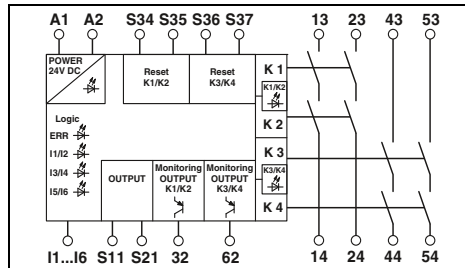

Technical data

| | |
|---|--|
| Input data | |
| Nominal input voltage U_N | 24 V DC |
| Permissible range (with reference to U_N) | 0.85 ... 1.1 |
| Typ. current consumption (with reference to U_N) | 125 mA (with actuated relays)/55 mA (two-channel 24 V/0 V + max. 200 mA control (message outputs 32/62) with non-actuated relays) |
| Recovery time | |
| | 1 s (availability time after activation of sensor circuit: 100ms) |
| Output data | |
| Contact type | |
| | 4 enabling current paths 2 semiconductor alarm outputs |
| Contact material | |
| Max./min. switching voltage | AgCuNi, +0.2 -0.4 μ m Au |
| Limiting continuous current | 250 V AC/DC/10 V AC/DC 6 A (N/O contact), max. 100 mA (Alarm output (24 V DC)) |
| Max./min. inrush current | |
| Min. switching power | 6 A/10 mA |
| Switching capacity (360/h cycles) | 0.1 W |
| Switching capacity (3600/h cycles) | 5 A (0.1 Hz; DC13; 24 V) 3 A (AC15; 230 V) |
| Short-circuit protection of the output circuits | 6 A gL/gG NEOZED (N/O contact), 4 A gL/gG NEOZED (for low-demand applications) |
| General data | |
| Ambient temperature range | |
| Air and creepage distances between the circuits | -20°C ... 45°C (see derating curve) DIN EN 50178/VDE 0160 |
| Rated surge voltage/insulation | 4 kV/basic isolation (safe isolation, reinforced insulation and 6 kV between input circuit, enabling current paths and safety circuit 1 (13/14, 23/24) and safety circuit 2 (43/44, 53/54).) |
| Dimensions | |
| W / H / D | 22.5 mm/112.2 mm/114.5 mm |
| Screw connection Solid/stranded/AWG | 0.2 - 2.5 mm ² /0.2 - 2.5 mm ² /24 - 12 |
| EMC note | Class A product, see page 443 |

△ FS

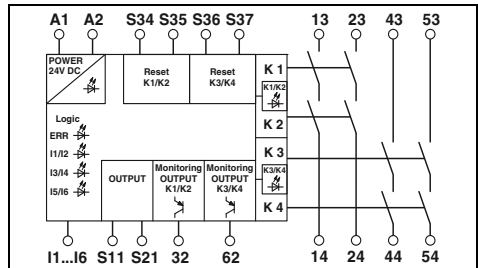

Technical data

| | |
|---|--|
| Input data | |
| Nominal input voltage U_N | 24 V DC |
| Permissible range (with reference to U_N) | 0.85 ... 1.1 |
| Typ. current consumption (with reference to U_N) | 125 mA (with actuated relays)/55 mA (two-channel 24 V/0 V + max. 200 mA control (message outputs 32/62) with non-actuated relays) |
| Recovery time | |
| | 1 s (availability time after activation of sensor circuit: 100ms) |
| Output data | |
| Contact type | |
| | 4 enabling current paths 2 semiconductor alarm outputs |
| Contact material | |
| Max./min. switching voltage | AgCuNi, +0.2 -0.4 μ m Au |
| Limiting continuous current | 250 V AC/DC/10 V AC/DC 6 A (N/O contact), max. 100 mA (Alarm output (24 V DC)) |
| Max./min. inrush current | |
| Min. switching power | 6 A/10 mA |
| Switching capacity (360/h cycles) | 0.1 W |
| Switching capacity (3600/h cycles) | 5 A (0.1 Hz; DC13; 24 V) 3 A (AC15; 230 V) |
| Short-circuit protection of the output circuits | 6 A gL/gG NEOZED (N/O contact), 4 A gL/gG NEOZED (for low-demand applications) |
| General data | |
| Ambient temperature range | |
| Air and creepage distances between the circuits | -20°C ... 45°C (see derating curve) DIN EN 50178/VDE 0160 |
| Rated surge voltage/insulation | 4 kV/basic isolation (safe isolation, reinforced insulation and 6 kV between input circuit, enabling current paths and safety circuit 1 (13/14, 23/24) and safety circuit 2 (43/44, 53/54).) |
| Dimensions | |
| W / H / D | 22.5 mm/117.4 mm/114.5 mm |
| Screw connection Solid/stranded/AWG | 0.2 - 1.5 mm ² /0.2 - 1.5 mm ² /24 - 16 |
| EMC note | Class A product, see page 443 |

Ordering data

| Description | Type | Order No. | Pcs. / Pkt. | |
|---|--|------------------------------|-------------|---|
| Multi-functional safety relay , three safety functions, one and two-channel, two local shutdown levels | - Emergency stop and safety door monitoring | PSR-SCP- 24DC/MXF1/4X1/2X2/B | 2902725 | 1 |
| | - Emergency stop and magnetic switch monitoring | PSR-SCP-24DC/MXF2/4X1/2X2/B | 2903254 | 1 |
| | - Emergency stop, safety door, and light grid monitoring | PSR-SCP-24DC/MXF3/4X1/2X2/B | 2903257 | 1 |
| | - Emergency stop, magnetic switch, and light grid monitoring | PSR-SCP-24DC/MXF4/4X1/2X2/B | 2903260 | 1 |

Ordering data

| Description | Type | Order No. | Pcs. / Pkt. | |
|---|--|-----------------------------|-------------|---|
| Multi-functional safety relay , three safety functions, one and two-channel, two local shutdown levels | - Emergency stop and safety door monitoring | PSR-SPP-24DC/MXF1/4X1/2X2/B | 2902726 | 1 |
| | - Emergency stop and magnetic switch monitoring | PSR-SPP-24DC/MXF2/4X1/2X2/B | 2903255 | 1 |
| | - Emergency stop, safety door, and light grid monitoring | PSR-SPP-24DC/MXF3/4X1/2X2/B | 2903258 | 1 |
| | - Emergency stop, magnetic switch, and light grid monitoring | PSR-SPP-24DC/MXF4/4X1/2X2/B | 2903261 | 1 |



Push-in connection

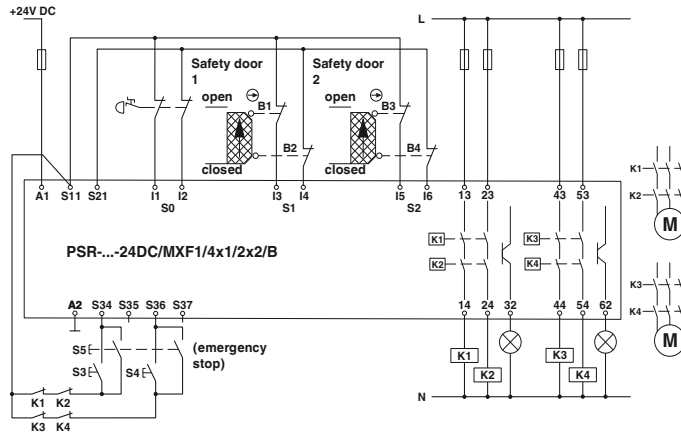

Emergency stop and safety door monitoring

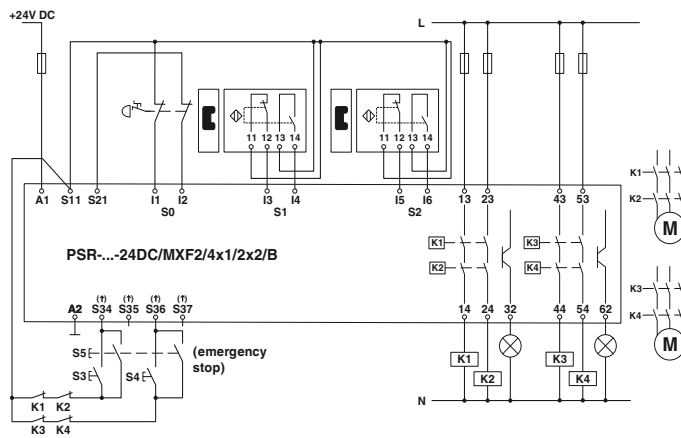

Emergency stop and magnetic switch monitoring

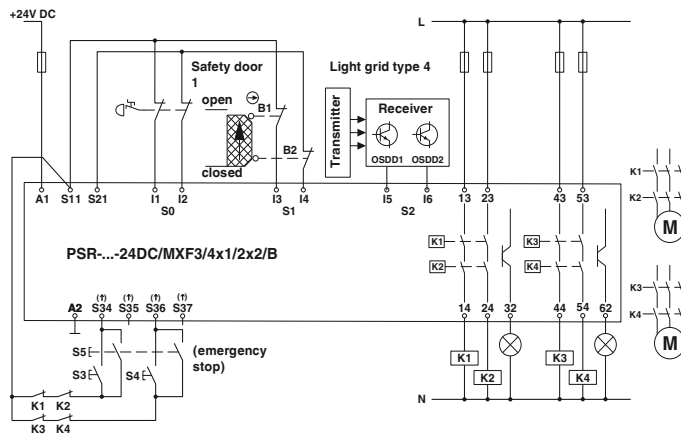

Emergency stop, safety door, and light grid monitoring

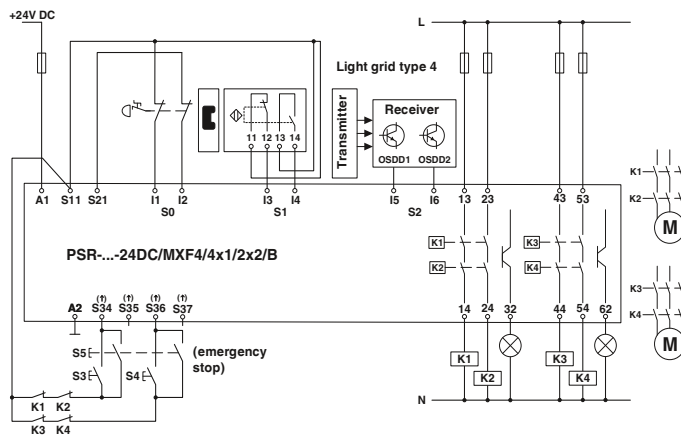

Emergency stop, magnetic switch, and light grid monitoring

FS

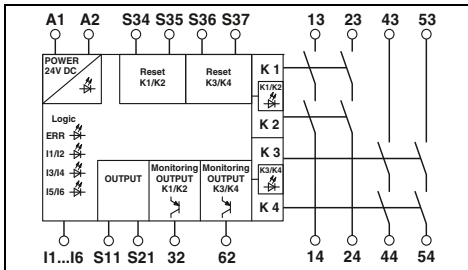

Technical data

24 V DC
0.85 ... 1.1
125 mA (with actuated relays)/55 mA (two-channel 24 V/0 V + max.
200 mA control (message outputs 32/62) with non-actuated relays)

1 s (availability time after activation of sensor circuit: 100ms)

4 enabling current paths
2 semiconductor alarm outputs
AgCuNi, +0.2 -0.4 μm Au
250 V AC/DC/10 V AC/DC
6 A (N/O contact), max. 100 mA (Alarm output (24 V DC))

6 A/10 mA
0.1 W
5 A (0.1 Hz; DC13; 24 V)
3 A (AC15; 230 V)
6 A gL/gG NEOZED (N/O contact),
4 A gL/gG NEOZED (for low-demand applications)

-20°C ... 45°C (see derating curve)
DIN EN 50178/VDE 0160
4 kV/basic isolation (safe isolation, reinforced insulation and 6 kV
between input circuit, enabling current paths and safety circuit 1
(13/14, 23/24) and safety circuit 2 (43/44, 53/54).)

22.5 mm/116.4 mm/114.5 mm
0.2 - 2.5 mm²/0.2 - 2.5 mm²/24 - 12
Class A product, see page 443

Ordering data

| Type | Order No. | Pcs. / Pkt. |
|-----------------------------|-----------|-------------|
| PSR-PIP-24DC/MXF1/4X1/2X2/B | 2903253 | 1 |
| PSR-PIP-24DC/MXF2/4X1/2X2/B | 2903256 | 1 |
| PSR-PIP-24DC/MXF3/4X1/2X2/B | 2903259 | 1 |
| PSR-PIP-24DC/MXF4/4X1/2X2/B | 2903262 | 1 |

PSR-TRISAFE modular

The PSR-TS-SDOR4 is a safe relay extension module for the PSR-TRISAFE-M safety module. It makes additional configurable relay outputs available to the master module.

Features:

- Output extension for PSR-TRISAFE-M (modular)
- 4 single-channel relay outputs or (configurable via SAFECONF) 2 two-channel relay outputs
- 4 signal outputs
- Slim 22.5 mm housing
- Including PSR-TBUS DIN rail connector for adapting to the PSR-TRISAFE-M master module
- Up to cat. 4/PL e according to EN ISO 13849-1
- Up to SIL 3 according to IEC 61508
- Up to SILCL 3 according to EN 62061

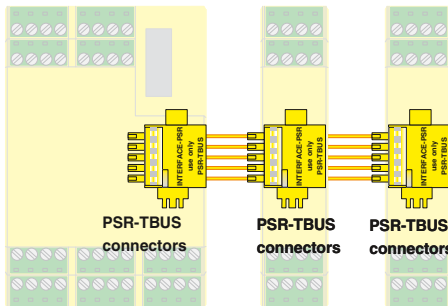

PSR-TBUS DIN rail connectors are used for cross-wiring between the modules.



Extension module with 4 relay outputs

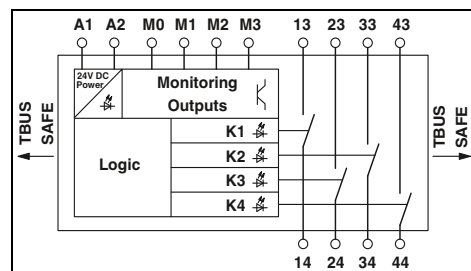

| | |
|---|------------------------|
| Module data | |
| Nominal input voltage U_N | 24 V DC (via PSR-TBUS) |
| Permissible range (with reference to U_N) | 0.85 ... 1.1 |
| Typ. current consumption (with reference to U_N) | 120 mA |
| Interfaces | |
| Output data | |
| Contact type | |
| Contact material | |
| Max./min. switching voltage | |
| Limiting continuous current | |
| Max./min. inrush current | |
| Min. switching power | |
| Switching capacity (3600/h cycles) | |
| Short-circuit protection of the output circuits | |
| Response time | |
| Alarm outputs | |
| General data | |
| Ambient temperature range | |
| Screw connection solid/stranded/AWG | |
| Spring-cage connection (solid/stranded/AWG) | |
| Dimensions | Screw version |
| W / H / D | Spring-cage version |
| EMC note | |

Technical data

| |
|---|
| 24 V DC (via PSR-TBUS) |
| 0.85 ... 1.1 |
| 120 mA |
| DIN rail TBUS for connection to the master module, supplied as standard |
| 4 enabling current paths |
| AgCuNi, + 0.2 μ m Au |
| 250 V AC/5 V AC/DC |
| 4 A (see derating curve) |
| 6 A/5 mA |
| 60 mW |
| 3 A (230 V (AC 15)); 5 A (24 V (DC13)) |
| 6 A gL/gG |
| Max. 50 ms |
| 4 |
| -20°C ... 55°C |
| 0.2 - 2.5 mm ² /0.2 - 2.5 mm ² /24 - 12 |
| 0.2 - 1.5 mm ² /0.2 - 1.5 mm ² /24 - 16 |
| 22.5 mm/99 mm/114.5 mm |
| 22.5 mm/112 mm/114.5 mm |
| Class A product, see page 443 |

| |
|--|
| Description |
| Extension module , 4 relay outputs (1-channel) or 2 relay outputs (2-channel) |
| With screw connection |
| With spring-cage connection |

Ordering data

| Type | Order No. | Pcs. / Pkt. |
|----------------------------|-----------|-------------|
| PSR-SCP- 24DC/TS/SDOR4/4X1 | 2986096 | 1 |
| PSR-SPP- 24DC/TS/SDOR4/4X1 | 2986106 | 1 |

| |
|--|
| Freely configurable master module , for monitoring emergency stops, safety doors, light grids, etc., with 20 safe inputs and 4 safe outputs, 4 alarm outputs and 2 clock outputs, safe and standard extension, including memory stick and PSR-TBUS DIN rail connector |
| With screw connection |
| With spring-cage connection |
| PSR-TBUS DIN rail connector , for supplying/controlling/monitoring (depending on the module) |

Accessories

| Type | Order No. | Pcs. / Pkt. |
|--------------------|-----------|-------------|
| PSR-SCP- 24DC/TS/M | 2986012 | 1 |
| PSR-SPP- 24DC/TS/M | 2986025 | 1 |
| PSR-TBUS | 2890425 | 50 |

Safe I/O modules

You can install the safety-related Axioline F PROFIsafe I/O modules anywhere inside an Axioline station. In addition to standard signals, this means you can now also read and output safe signals in the Axioline system.

Depending on the installation and parameterization, you can achieve the following safety characteristics with these modules:

- Up to cat. 4/PL e according to EN ISO 13849-1
- Up to SIL 3 according to IEC 61508
- Up to SILCL 3 according to EN 62061



Digital input module



Technical data

| | |
|--|--|
| Local bus interface | Axioline F local bus |
| Name | Bus base module |
| Connection method | |
| Power supply for module electronics | |
| Communications power U_{Bus} | 5 V DC (via bus base module) |
| Current consumption from U_{Bus} | Typ. 280 mA (Normal operation) |
| I/O supply | |
| Supply of digital input modules U_i | 24 V DC |
| Supply voltage range U_i | 19.2 V DC ... 30.2 V DC (including all tolerances, including ripple) |
| Current consumption from U_i | Typ. 40 mA (when using the appropriate clock supply) |
| Protective circuit | Protection against polarity reversal, EMC protective circuit, undervoltage detection |
| Digital inputs | |
| Connection method | 2, 3, 4-wire |
| Number of inputs | 4 (with two-channel assignment) 8 (for single-channel assignment) |
| Description of the inputs | IEC 61131-2 type 3 |
| Nominal input voltage U_{IN} | 24 V DC |
| Nominal input current at U_{IN} | Typ. 4.2 mA |
| Input filter time | 1.5 ms 3 ms (default) 5 ms 15 ms |
| General data | |
| Connection method | Direct plug-in technology |
| Connection data solid / stranded / AWG | 0.2 ... 1.5 mm ² /0.2 ... 1.5 mm ² /24 - 16 |
| Weight | 220 g |
| Width | 53.6 mm |
| Height | 126.1 mm |
| Depth | 54 mm |
| Ambient temperature (operation) | -35°C ... 60°C (mounting position: any) |

Ordering data

| Description | Type | Order No. | Pcs. / Pkt. |
|---|-------------------------|----------------|-------------|
| Fail-safe digital input module | | | |
| - 4 inputs (two-channel), 8 inputs (single-channel) | AXL F PSDI8/4 1F | 2701559 | 1 |

Safe I/O modules

You can install the safety-related Axioline F PROFI-safe I/O modules anywhere inside an Axioline station. In addition to standard signals, this means you can now also read and output safe signals in the Axioline system.

Depending on the installation and parameterization, you can achieve the following safety characteristics with these modules:

- Up to cat. 4/PL e according to EN ISO 13849-1
- Up to SIL 3 according to IEC 61508
- Up to SILCL 3 according to EN 62061

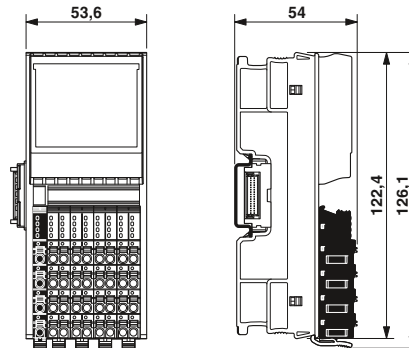

Digital output module

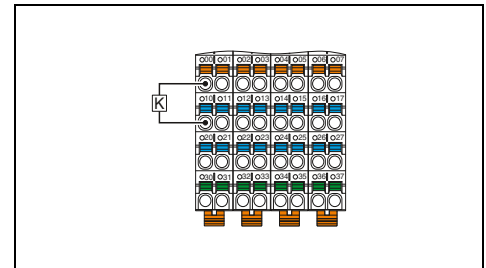

Technical data

| | |
|--|--|
| Local bus interface | |
| Name | Axioline F local bus |
| Connection method | Bus base module |
| Power supply for module electronics | |
| Communications power U_{Bus} | 5 V DC (via bus base module) |
| Current consumption from U_{Bus} | Typ. 260 mA (Normal operation) |
| I/O supply | |
| Supply of digital output modules U_o | 24 V DC |
| Supply voltage range U_o | 19.2 V DC ... 30.2 V DC (including all tolerances, including ripple) |
| Current consumption from U_o | Typ. 26 mA (all outputs set including actuator current) |
| Protective circuit | Protection against polarity reversal, EMC protective circuit, undervoltage detection |
| Digital outputs | |
| Connection method | 2, 3-wire |
| Number of outputs | 4 (with two-channel assignment) 8 (for single-channel assignment) |
| Output voltage | 24 V DC |
| Maximum output current per channel | 2 A |
| Maximum output current per module / terminal block | 8 A |
| Behavior with overload | Affected output is disabled and a diagnostic message is generated. |
| Protective circuit | Overload protection, freewheeling circuit for inductive loads, Discharge circuit for accelerated discharge of capacitive loads |
| General data | |
| Connection method | Direct plug-in technology |
| Connection data solid / stranded / AWG | 0.2 ... 1.5 mm ² /0.2 ... 1.5 mm ² /24 - 16 |
| Weight | 220 g |
| Width | 53.6 mm |
| Height | 126.1 mm |
| Depth | 54 mm |
| Ambient temperature (operation) | -35°C ... 60°C (mounting position: any) |

Ordering data

| Description | Type | Order No. | Pcs. / Pkt. |
|---|-------------------------|----------------|-------------|
| Fail-safe digital output module | AXL F PSD08/3 1F | 2701560 | 1 |
| - 4 outputs (two-channel), 8 outputs (single-channel) | | | |

Safe analog value processing

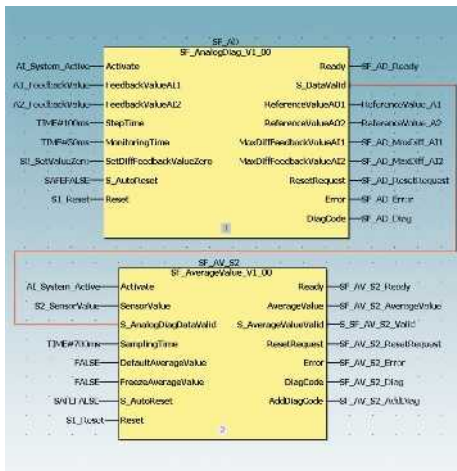

Wherever analog values need to be processed in a safety-related manner, the Safe AI solution package from Phoenix Contact is the ideal solution. With this TÜV-certified and software-based analog value processing, no safety-related I/O modules are required. This saves you money and offers flexibility.

Components of the Safe AI solution package:

- Initial application advice via telephone on the required software and hardware components
- License key for using the ANALOGINPUT_SF function block library including user documentation
- Advice from the Competence Center Safety in the form of a web meeting

24-hour safety hotline

+49 5281 9-462777
 safety-service@phoenixcontact.com

| Description |
|---|
| Function block library for safety-related analog acquisition with standard I/O modules |

| Ordering data | | |
|---------------|-----------|-------------|
| Type | Order No. | Pcs. / Pkt. |
| SAFE AI | 2400057 | 1 |

Bus couplers

The Axioline F bus coupler is the link between the Axioline F system and the higher-level third-generation Sercos network.

For startup tests, the Axioline F station can be started up independently of the higher-level network via either the service interface or an Ethernet port on the bus coupler using the Startup+ software.

Features:

- Sercos specification V1.3
- Minimum Sercos cycle time of 31.25 μs
- Two rotary encoding switches for address assignment
- 2 RJ45 connections (with integrated switch)
- Up to 63 additional Axioline devices can be connected
- Typical cycle time of the Axioline F local bus is around 10 μs
- Runtime in bus coupler is negligible (almost 0 μs)
- FSP-IO (Function Specific Profile-IO) for modular I/O devices
- Firmware can be updated
- Diagnostic and status indicators

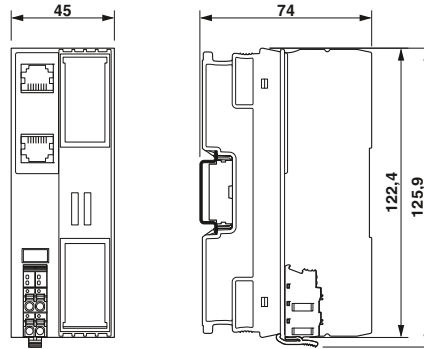

sercos
the automation bus



Sercos III bus coupler

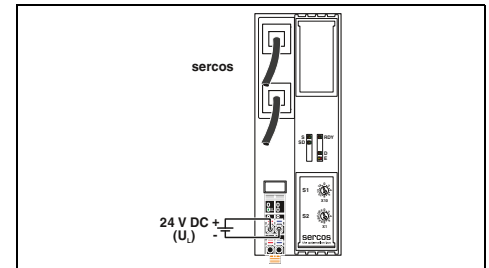

Technical data

| | |
|---|--|
| Interface | |
| Fieldbus system | Sercos |
| Connection method | RJ45 socket, auto negotiation and auto crossing |
| Number | 2 |
| Transmission speed | 100 Mbps (full duplex) |
| Transmission length | Max. 100 m |
| Network/bus system | |
| Device profile | FSP_IO |
| Equipment type | Sercos slave |
| Update rate | 31.25 μs |
| Local bus interface | |
| Name | Axioline F local bus |
| Connection method | Bus base module |
| Transmission speed | 100 Mbps |
| Number of supported devices | Max. 63 (per station) |
| Power supply for module electronics | |
| Supply of communications power U _L | 24 V DC |
| Maximum permissible voltage range | 19.2 V DC ... 30 V DC (including all tolerances, including ripple) |
| Communications power U _{Bus} | |
| Current supply at U _{Bus} | 5 V DC (via bus base module) |
| Protective circuit | 2 A |
| General data | |
| Connection method | Push-in technology |
| Connection data solid / stranded / AWG | 0.2 ... 1.5 mm ² /0.2 ... 1.5 mm ² /24 - 16 |
| Weight | 177 g |

| | | |
|--|--|--|
| Sercos | | |
| RJ45 socket, auto negotiation and auto crossing | | |
| 2 | | |
| 100 Mbps (full duplex) | | |
| Max. 100 m | | |
| FSP_IO | | |
| Sercos slave | | |
| 31.25 μs | | |
| Axioline F local bus | | |
| Bus base module | | |
| 100 Mbps | | |
| Max. 63 (per station) | | |
| 24 V DC | | |
| 19.2 V DC ... 30 V DC (including all tolerances, including ripple) | | |
| 5 V DC (via bus base module) | | |
| 2 A | | |
| Surge protection of the supply voltage | | |
| Polarity reversal protection of the supply voltage | | |

Ordering data

| | |
|-----------------------------|--|
| Description | |
| Axioline bus coupler | |
| - For Sercos | |

| Type | Order No. | Pcs. / Pkt. |
|--------------------|----------------|-------------|
| AXL F BK S3 | 2701686 | 1 |

Accessories

| |
|--|
| Axioline bus base module (replacement part) |
|--|

| | | |
|------------------|----------------|----------|
| AXL BS BK | 2701422 | 5 |
|------------------|----------------|----------|

Bus coupler

The Axioline F bus coupler is the link between the Axioline F system and the higher-level Ethernet system.

The new version of the device features web-based management. It can be used to access static information (e.g., technical data, MAC address, IP address) or dynamic information (e.g., IP address, status information).

For startup tests, the Axioline F station can be started up independently of the higher-level network via either the service interface or an Ethernet port on the bus coupler using the Startup+ software.

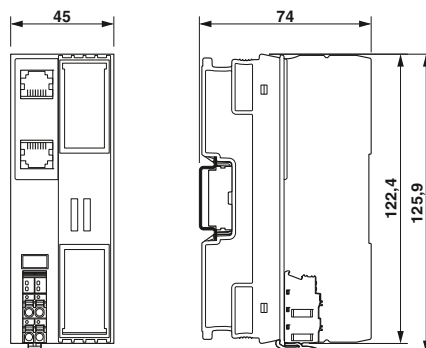

PROFINET bus coupler



Features:

- PROFINET RT and PROFINET IRT support
- Minimum cycle time of PROFINET for RT and IRT is 250 μs
- Module replacement without software possible
- 2 RJ45 connections (with integrated switch)
- Up to 63 additional Axioline devices can be connected
- Typical cycle time of the Axioline F local bus is around 10 μs
- MRP client
- Shared device
- Firmware can be updated
- Diagnostic and status indicators

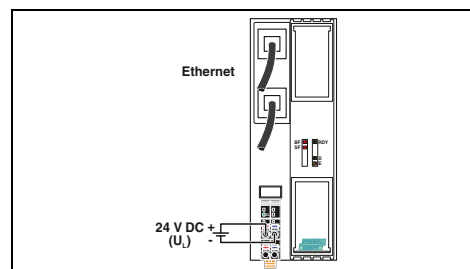

| | |
|--|--|
| Interface | |
| Fieldbus system | PROFINET |
| Connection method | RJ45 socket, auto negotiation and autocrossing |
| Number | 2 |
| Transmission speed | 100 Mbps (full duplex) |
| Transmission length | Max. 100 m |
| Local bus interface | |
| Name | Axioline F local bus |
| Connection method | Bus base module |
| Transmission speed | 100 Mbps |
| Number of supported devices | Max. 63 (per station) |
| Power supply for module electronics | |
| Supply of communications power U_L | 24 V DC |
| Maximum permissible voltage range | 19.2 V DC ... 30 V DC (including all tolerances, including ripple) |
| Communications power U_{Bus} | 5 V DC (via bus base module) |
| Current supply at U_{Bus} | 2 A |
| Protective circuit | Surge protection of the supply voltage Polarity reversal protection of the supply voltage |
| General data | |
| Connection method | Push-in technology |
| Connection data solid / stranded / AWG | 0.2 ... 1.5 mm ² /0.2 ... 1.5 mm ² /24 - 16 |
| Weight | 177 g |

Technical data

| | | |
|--|--|--|
| Technical data | | |
| PROFINET | | |
| RJ45 socket, auto negotiation and autocrossing | | |
| 2 | | |
| 100 Mbps (full duplex) | | |
| Max. 100 m | | |
| Local bus interface | | |
| Axioline F local bus | | |
| Bus base module | | |
| 100 Mbps | | |
| Max. 63 (per station) | | |
| Power supply for module electronics | | |
| 24 V DC | | |
| 19.2 V DC ... 30 V DC (including all tolerances, including ripple) | | |
| Communications power U_{Bus} | | |
| 5 V DC (via bus base module) | | |
| 2 A | | |
| Surge protection of the supply voltage | | |
| Polarity reversal protection of the supply voltage | | |
| General data | | |
| Push-in technology | | |
| 0.2 ... 1.5 mm ² /0.2 ... 1.5 mm ² /24 - 16 | | |
| 177 g | | |

| |
|---|
| Description |
| Axioline bus coupler - For PROFINET |

Ordering data

| Type | Order No. | Pcs. / Pkt. |
|-------------|-----------|-------------|
| AXL F BK PN | 2701815 | 1 |

| |
|--|
| Axioline bus base module (replacement part) |
|--|

Accessories

| | | |
|-----------|---------|---|
| AXL BS BK | 2701422 | 5 |
|-----------|---------|---|

Digital input and output modules

This module is designed for use within an Axioline F station.

It is used to acquire and output digital data.

You can adjust the filter times of the inputs to increase noise immunity. Filter times of 100 µs enable you to implement a counting function with a maximum input frequency of 5 kHz in the application.

Features:

- 8 digital inputs and 8 digital outputs
- 24 V DC, 500 mA
- Connection of sensors or actuators in single-wire technology
- Minimum update time < 100 µs, bus synchronous
- Filter times can be set in three increments: < 100 µs, 1000 µs or 3000 µs
- Maximum input frequency: 5 kHz
- Short-circuit-proof outputs
- Stored device rating plate
- Diagnostic and status indicators

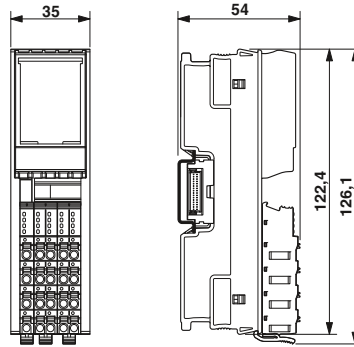

8 digital inputs and 8 digital outputs

BSH

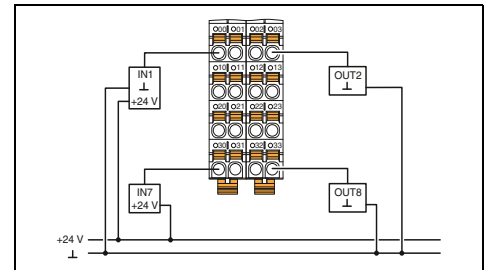

Technical data

| | |
|--|--|
| Local bus interface | Axioline F local bus |
| Name | Bus base module |
| Connection method | |
| Power supply for module electronics | 5 V DC (via bus base module) |
| Communications power U _{Bus} | Max. 120 mA |
| Current consumption from U _{Bus} | |
| I/O supply | 24 V DC |
| Digital input and output module supply U _{IO} | |
| Supply voltage range U _{IO} | 19.2 V DC ... 30 V DC (including all tolerances, including ripple) |
| Protective circuit | Surge protection of the supply voltage Polarity reversal protection of the supply voltage |
| Digital inputs | 1-wire |
| Connection method | 8 |
| Number of inputs | EN 61131-2 types 1 and 3 |
| Description of the inputs | 24 V DC |
| Nominal input voltage U _{IN} | 2.4 mA |
| Nominal input current at U _{IN} | < 100 µs |
| Input filter time | 1000 µs |
| | 3000 µs (default) |
| Protective circuit | Polarity reversal protection of the inputs |
| Digital outputs | 1-wire |
| Connection method | 8 |
| Maximum number of outputs | 24 V |
| Output voltage | 500 mA |
| Maximum output current per channel | 4 A (external fuse) |
| Maximum output current per module | Shutdown with automatic restart |
| Behavior with overload | Short-circuit protection, overload protection of the outputs |
| Protective circuit | |
| General data | |
| Connection method | Push-in technology |
| Connection data solid / stranded / AWG | 0.2 ... 1.5 mm ² /0.2 ... 1.5 mm ² /24 - 16 |
| Weight | 133 g |
| Width | 35 mm |
| Height | 126.1 mm |
| Depth | 54 mm |
| EMC note | Class A product, see page 443 |

Ordering data

| Type | Order No. | Pcs. / Pkt. |
|----------------------|-----------|-------------|
| AXL F DI8/1 DO8/1 1H | 2701916 | 1 |

Accessories

| | | |
|------------|---------|---|
| AXL F BS H | 2700992 | 5 |
|------------|---------|---|

| | |
|---|--|
| Description | Axioline digital input/output module, complete with accessories (bus base module) - 8 inputs, 8 outputs |
| Axioline bus base module (replacement part) | |

Analog input modules

This module is designed for use within an Axioline F station.

It is used to acquire standard analog voltage signals. Connection is via 2, 3 or 4-wire technology and a shield connection.

Features:

- 4 analog differential signal inputs
- Voltage measuring ranges
- Input filter selection
- Minimum update time of 250 µs, bus synchronous
- 16-bit measured value representation
- Stored device rating plate
- Integrated sensor supply
- Diagnostic and status indicators

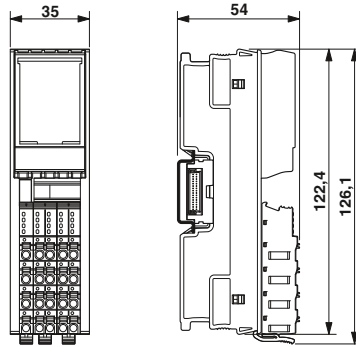

**4 analog inputs
Voltage signals**

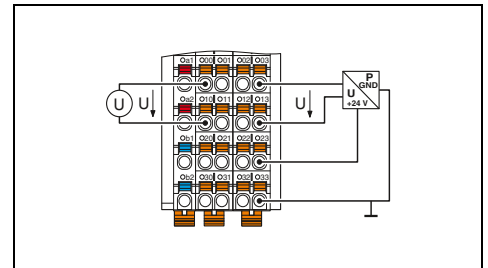

| Local bus interface | |
|---|---|
| Name | Axioline F local bus |
| Connection method | Bus base module |
| Power supply for module electronics | |
| Communications power U _{Bus} | 5 V DC (via bus base module) |
| Current consumption from U _{Bus} | Max. 150 mA |
| I/O supply | |
| Supply of analog modules U _A | 24 V DC |
| Protective circuit | Surge protection Protection against polarity reversal Transient protection |
| Analog inputs | |
| Connection method | 2, 3, 4-wire (shielded) |
| Number of inputs | Max. 4 (differential inputs, voltage) |
| Voltage input signal | 0 V ... 5 V/-5 V ... 5 V/0 V ... 10 V/-10 V ... 10 V |
| Characteristics | |
| Measured value representation | 16 bits (15 bits + sign bit) |
| Input filter | 30 Hz, 12 kHz and mean-value generation (can be parameterized) |
| Precision | 0.1% (of measuring range final value for active mean-value generation and 30 Hz filter) |
| General data | |
| Connection method | Push-in technology |
| Connection data solid / stranded / AWG | 0.2 ... 1.5 mm ² /0.2 ... 1.5 mm ² /24 - 16 |
| Weight | 145 g |

Technical data

Ordering data

| Description | Type | Order No. | Pcs. / Pkt. |
|---|-----------------------|----------------|-------------|
| Axioline analog input module , complete with accessories (bus base module) - 4 inputs | AXL F AI4 U 1H | 2688501 | 1 |

Accessories

| | | | |
|--|-----------------------|----------------|----------|
| Axioline bus base module (replacement part) | AXL F BS H | 2700992 | 5 |
| Axioline shield connection set | AXL SHIELD SET | 2700518 | 1 |

Analog input modules

This module is designed for use within an Axioline F station.

It is used to acquire standard analog current signals. Connection is via 2, 3 or 4-wire technology and a shield connection.

Features:

- 4 analog differential signal inputs
- Current measuring ranges
- Input filter selection
- Minimum update time of 250 µs, bus synchronous
- 16-bit measured value representation
- Stored device rating plate
- Integrated sensor supply
- Diagnostic and status indicators

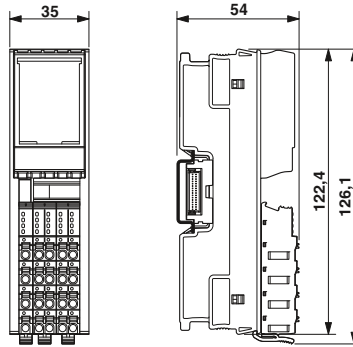

4 analog inputs
Current signals

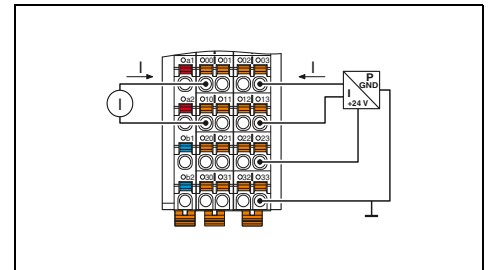

Technical data

| | |
|--|---|
| Local bus interface | |
| Name | Axioline F local bus |
| Connection method | Bus base module |
| Power supply for module electronics | |
| Communications power U_{Bus} | 5 V DC (via bus base module) |
| Current consumption from U_{Bus} | Max. 150 mA |
| I/O supply | |
| Supply of analog modules U_A | 24 V DC |
| Protective circuit | Surge protection Protection against polarity reversal Transient protection |
| Analog inputs | |
| Connection method | 2, 3, 4-wire (shielded) |
| Number of inputs | Max. 4 (differential inputs, current) |
| Current input signal | 0 mA ... 20 mA/4 mA ... 20 mA/-20 mA ... 20 mA |
| Characteristics | |
| Measured value representation | 16 bits (15 bits + sign bit) |
| Input filter | 30 Hz, 12 kHz and mean-value generation (can be parameterized) |
| Precision | 0.1% (of measuring range final value for active mean-value generation and 30 Hz filter) |
| General data | |
| Connection method | Push-in technology |
| Connection data solid / stranded / AWG | 0.2 ... 1.5 mm ² /0.2 ... 1.5 mm ² /24 - 16 |
| Weight | 145 g |

Ordering data

| Type | Order No. | Pcs. / Pkt. |
|----------------|-----------|-------------|
| AXL F AI4 I 1H | 2688491 | 1 |

Accessories

| | | | |
|---|----------------|---------|---|
| Axioline bus base module (replacement part) | AXL F BS H | 2700992 | 5 |
| Axioline shield connection set | AXL SHIELD SET | 2700518 | 1 |

| | |
|-------------|---|
| Description | Axioline analog input module , complete with accessories (bus base module) - 4 inputs |
|-------------|---|

Analog output modules

This module is designed for use within an Axioline F station.

The module is used to output standard analog current and voltage signals. It is connected using 2-wire technology and a shield connection.

Features:

- 4 analog outputs
- Bipolar voltage outputs, Unipolar current outputs
- Minimum update time of 250 μ s, bus synchronous
- 16-bit output value
- Overload and short-circuit protected
- Stored device rating plate
- Diagnostic and status indicators

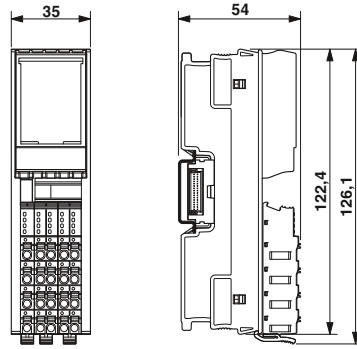

**4 analog outputs
Current/voltage signals**

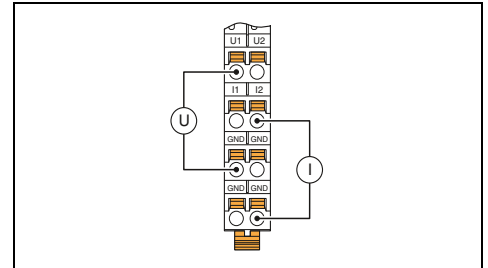

| Local bus interface | |
|--|---|
| Name | Axioline F local bus |
| Connection method | Bus base module |
| Power supply for module electronics | |
| Communications power U_{bus} | 5 V DC (via bus base module) |
| Current consumption from U_{bus} | Max. 150 mA |
| I/O supply | |
| Supply of analog modules U_A | 24 V DC |
| Analog outputs | |
| Connection method | 2-wire (shielded, twisted pair) |
| Number of outputs | 4 |
| Voltage output signal | 0 V ... 5 V/-5 V ... 5 V/0 V ... 10 V/-10 V ... 10 V |
| Current output signal | 0 mA ... 20 mA/4 mA ... 20 mA |
| Load/output load current output | to 500 Ω |
| Protective circuit | Short-circuit and overload protection Transient protection |
| Characteristics | |
| Representation of output values | 16 bits (15 bits + sign) |
| Precision | Typ. 0.1% (of output range final value) |
| General data | |
| Connection method | Push-in technology |
| Connection data solid / stranded / AWG | 0.2 ... 1.5 mm ² /0.2 ... 1.5 mm ² /24 - 16 |
| Weight | 145 g |

Technical data

Ordering data

| Description | Type | Order No. | Pcs. / Pkt. |
|---|---------------------|----------------|-------------|
| Axioline analog output module , complete with accessories (bus base module) - 4 outputs | AXL F AO4 1H | 2688527 | 1 |

Accessories

| | | | |
|--|-----------------------|----------------|----------|
| Axioline bus base module (replacement part) | AXL F BS H | 2700992 | 5 |
| Axioline shield connection set | AXL SHIELD SET | 2700518 | 1 |

Temperature recording modules

This module is designed for use within an Axioline F station.

It is used to record resistive temperature sensors. Connection is via 2, 3 or 4-wire technology and a shield connection.

RTD features:

- 4 inputs for temperature shunts
- 500 Ω and 5 kΩ linear inputs
- Programmable filters
- Short-circuit-proof inputs
- Stored device rating plate

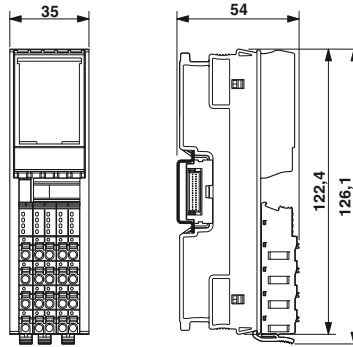

4 RTD inputs

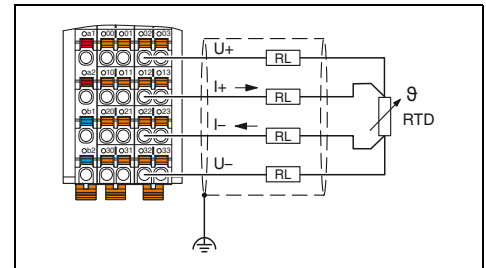

Technical data

| | |
|--|---|
| Local bus interface | Axioline F local bus |
| Name | Bus base module |
| Connection method | |
| Power supply for module electronics | 5 V DC (via bus base module) |
| Communications power U_{Bus} | Max. 140 mA |
| Current consumption from U_{Bus} | |
| I/O supply | 24 V DC |
| Supply of analog modules U_A | Surge protection |
| Protective circuit | Protection against polarity reversal |
| | Transient protection |
| Analog inputs | 2, 3, 4-wire (shielded) |
| Connection method | 4 (for resistance temperature detectors) |
| Number of inputs | Short-circuit protection, overload protection of the inputs |
| Protective circuit | Transient protection of inputs |
| | Transient protection of sensor supplies |
| Sensor types (RTD) that can be used | Pt, Ni, KTY, Cu sensors |
| Linear resistance measuring range | 0 Ω ... 500 Ω/0 kΩ ... 5 kΩ |
| Characteristics | 16 bits (15 bits + sign bit) |
| Measured value representation | 40 ms/60 ms/100 ms/120 ms (adjustable) |
| Input filter time | Typ. ± 0.1 K (Pt100 with 3-wire termination) |
| Accuracy | |
| General data | Push-in technology |
| Connection method | 0.2 ... 1.5 mm ² /0.2 ... 1.5 mm ² /24 - 16 |
| Connection data solid / stranded / AWG | 144 g |
| Weight | |

Ordering data

| Type | Order No. | Pcs. / Pkt. |
|----------------------|----------------|-------------|
| AXL F RTD4 1H | 2688556 | 1 |

Accessories

| | | | |
|--|-----------------------|---------|---|
| Axioline bus base module (replacement part) | AXL F BS H | 2700992 | 5 |
| Axioline shield connection set | AXL SHIELD SET | 2700518 | 1 |

Temperature recording modules

This module is designed for use within an Axioline F station.

It is used to acquire data from thermocouples. Connection is via 2-wire technology and a shield connection.

Features of UTH:

- 4 inputs for thermocouples
- Linear voltages from -100 mV to +100 mV
- 1 input from -5 V to +5 V
- 2 Pt 100 inputs (external cold junction)
- Configurable cold junction type
- Stored device rating plate



4 UTH inputs

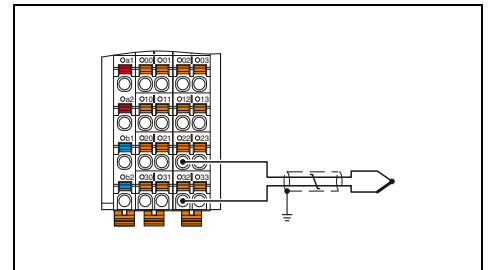

Technical data

| | |
|--|--|
| Local bus interface | |
| Name | Axioline F local bus |
| Connection method | Bus base module |
| Power supply for module electronics | |
| Communications power U_{Bus} | 5 V DC (via bus base module) |
| Current consumption from U_{Bus} | Max. 40 mA |
| I/O supply | |
| Supply of analog modules U_A | 24 V DC |
| Protective circuit | Surge protection of the supply voltage Polarity reversal protection of the supply voltage Transient protection |
| Analog inputs | |
| Connection method | 2-wire (shielded, twisted pair) |
| Number of inputs | 4 + 1 (4 inputs for thermocouples or linear voltage, plus 1 input -5 V to +5 V) |
| Protective circuit | Short-circuit protection, overload protection of the inputs Transient protection of inputs |
| Sensor types (RTD) that can be used | Pt 100 (2 external cold junctions, can also be used as a sensor input) |
| Linear voltage range | -100 mV ... 100 mV |
| Characteristics | |
| Measured value representation | 16 bits (15 bits + sign bit) |
| Input filter time | 40 ms/60 ms/100 ms/120 ms (adjustable) |
| Accuracy | Typ. ± 0.19 K (Thermocouple type K, plus tolerance of cold junction) |
| General data | |
| Connection method | Push-in technology |
| Connection data solid / stranded / AWG | 0.2 ... 1.5 mm ² /0.2 ... 1.5 mm ² /24 - 16 |
| Weight | 144 g |

Ordering data

| Description | Type | Order No. | Pcs. / Pkt. |
|--|----------------------|----------------|-------------|
| Axioline analog input module , complete with accessories (bus base module) - 4 inputs for connection of thermocouple sensors | AXL F UTH4 1H | 2688598 | 1 |

Accessories

| | | | |
|--|-----------------------|----------------|----------|
| Axioline bus base module (replacement part) | AXL F BS H | 2700992 | 5 |
| Axioline shield connection set | AXL SHIELD SET | 2700518 | 1 |

M-bus master terminal

The Inline terminal is designed for use within an Inline station.

It enables communication with standard M-bus counters according to EN 13757.

Features:

- M-bus connection for up to 30 devices
- Transmission speed can be set from 300 baud to 19,200 baud
- Parameterization via process data
- Process data width: 16 words
- Diagnostic and status indicators

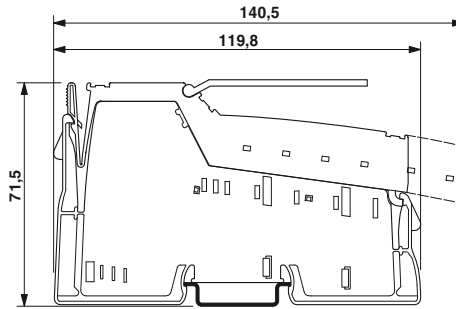

M-bus master

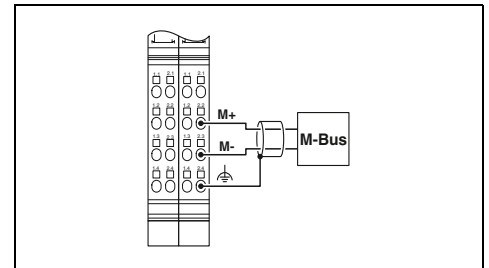

| |
|--|
| Local bus interface |
| Connection method |
| Communication interface |
| Interface |
| Connection method |
| Power supply for module electronics |
| Communications power U_L |
| Current consumption from U_L |
| General data |
| Connection method |
| Connection data solid / stranded / AWG |
| Weight |
| Width |
| Ambient temperature (operation) |

| Technical data | |
|---|--|
| Inline data jumper | |
| M-Bus | |
| Inline plugs | |
| 7.5 V (via potential jumper) | |
| Typ. 65 mA | |
| Spring-cage connection | |
| 0.08 ... 1.5 mm ² /0.08 ... 1.5 mm ² /28 - 16 | |
| 125 g | |
| 24.4 mm | |
| -25°C ... 55°C | |

| Description |
|--|
| Inline Modular communication terminal , complete with accessories (connector plug and labeling field) |
| - for the connection of M-bus devices |

| Ordering data | | |
|-----------------------|----------------|-------------|
| Type | Order No. | Pcs. / Pkt. |
| IB IL MBUS-PAC | 2701927 | 1 |

HMI and industrial PCS - HMIs

HMI for maritime applications

HMI devices for maritime applications are the reliable and robust solution for demanding applications on ships. The touch panels are specifically tested and approved for shipbuilding.

Your advantages:

- Tested quality - certified according to GL, LR, BV, DNV, and ABS
- Flexible communication, even with third-party systems, thanks to numerous drivers
- Save costs and increase service life, thanks to LED backlighting that can be adjusted directly via buttons
- Increase system availability, thanks to temperature and voltage monitoring
- Save costs for acoustic signaling devices: integrated buzzer
- Global use: additional fonts are easy to install
- Cost-effective solution, since there are no additional costs for SCADA runtime: unlimited runtime license for Visu+ RT and AX OPC Server included



17.8 cm (7") TFT color display

| |
|---------------------------------|
| Display data |
| Display |
| Monitor resolution |
| Display lighting type |
| Brightness |
| Display backlight MTBF |
| Color spectrum |
| Touch screen |
| Computer data |
| Operating systems |
| Processor |
| RAM |
| Mass storage |
| Interfaces |
| Network |
| External dimensions |
| Width |
| Height |
| Depth |
| Installation dimensions |
| Width |
| Height |
| Installation depth |
| General data |
| Degree of protection |
| Ambient temperature (operation) |
| Mounting type |
| Vibration (operation) |
| Shock |
| EMC note |

| Technical data | |
|--|--|
| 17.8 cm/7" TFT | |
| 800 x 480 pixels (WVGA) | |
| LED | |
| 350 cd/m ² , typical (adjustable) | |
| 50000 h | |
| 65,536 colors | |
| Resistive industrial touch screen | |
| Windows CE 6.0 | |
| Xscale® PXA320, 806 MHz | |
| 128 MByte SDRAM | |
| 1 GB Flash | |
| 2x USB Host 1.1, 1x Compact Flash® | |
| 1 x Ethernet (10/100 Mbps), RJ45 | |
| IP65 (front), IP20 (back) | |
| 0°C ... 55°C | |
| Installation in front plate | |
| DIN EN 60068-2-6 | |
| DIN EN 60068-2-27 | |
| Class A product, see page 443 | |

| |
|---|
| Description |
| Touch panel with graphics-capable display, for maritime applications |

| Ordering data | | |
|---------------|-----------|-------------|
| Type | Order No. | Pcs. / Pkt. |
| TP 07T/M 211 | 2701452 | 1 |

| |
|---|
| Stylus for touch screens |
| USB Flash memory |
| CMOS battery |
| Mounting kit , including hardware for installation |
| - panel installation |
| Protective foil for touch screen |

| Accessories | | |
|----------------------------|-----------|-------------|
| Type | Order No. | Pcs. / Pkt. |
| TOUCH PEN | 2701379 | 1 |
| 2 GB USB STICK | 2701382 | 1 |
| HMI BATTERY | 2701383 | 1 |
| HMI SCB MOUNTING KIT 6 | 2701385 | 1 |
| 7" DISPLAY PROTECTIVE FOIL | 2701374 | 1 |



26.4 cm (10.4") TFT color display



30.7 cm (12.1") TFT color display



38.1 cm (15") color TFT display

| Technical data |
|--|
| 26.4 cm/10.4" TFT |
| 640 x 480 pixels (VGA) |
| LED |
| 350 cd/m ² , typical (adjustable) |
| 50000 h |
| 65,536 colors |
| Resistive industrial touch screen |
| Windows CE 6.0 |
| Xscale® PXA320, 806 MHz |
| 128 MByte SDRAM |
| 1 GB Flash |
| 2x USB Host 1.1, 1x Compact Flash® |
| 1 x Ethernet (10/100 Mbps), RJ45 |
| 328 mm |
| 265 mm |
| 5 mm |
| 303 mm |
| 238 mm |
| 57 mm |
| IP65 (front), IP20 (back) |
| 0°C ... 55°C |
| Installation in front plate |
| DIN EN 60068-2-6 |
| DIN EN 60068-2-27 |
| Class A product, see page 443 |

| Technical data |
|--|
| 30.7 cm/12.1" TFT |
| 800 x 600 pixels (SVGA) |
| LED |
| 300 cd/m ² , typical (adjustable) |
| 50000 h |
| 65,536 colors |
| Resistive industrial touch screen |
| Windows CE 6.0 |
| Xscale® PXA320, 806 MHz |
| 128 MByte SDRAM |
| 1 GB Flash |
| 2x USB Host 1.1, 1x Compact Flash® |
| 1 x Ethernet (10/100 Mbps), RJ45 |
| 340 mm |
| 285 mm |
| 5 mm |
| 315 mm |
| 259 mm |
| 62 mm |
| IP65 (front), IP20 (back) |
| 0°C ... 55°C |
| Installation in front plate |
| DIN EN 60068-2-6 |
| DIN EN 60068-2-27 |
| Class A product, see page 443 |

| Technical data |
|------------------------------------|
| 38.1 cm/15" TFT |
| 1024 x 768 pixels (XGA) |
| LED |
| 480 cd/m ² |
| 50000 h |
| 256 colors |
| Resistive industrial touch screen |
| Windows CE 6.0 |
| Xscale® PXA320, 806 MHz |
| 128 MByte SDRAM |
| 1 GB Flash |
| 2x USB Host 1.1, 1x Compact Flash® |
| 1 x Ethernet (10/100 Mbps), RJ45 |
| 400 mm |
| 338 mm |
| 5 mm |
| 373 mm |
| 312 mm |
| 62 mm |
| IP65 (front), IP20 (back) |
| 0°C ... 55°C |
| Installation in front plate |
| DIN EN 60068-2-6 |
| DIN EN 60068-2-27 |
| Class A product, see page 443 |

| Ordering data | | |
|---------------|-----------|-------------|
| Type | Order No. | Pcs. / Pkt. |
| TP 10T/M 211 | 2701843 | 1 |

| Ordering data | | |
|---------------|-----------|-------------|
| Type | Order No. | Pcs. / Pkt. |
| TP 12T/M 211 | 2701844 | 1 |

| Ordering data | | |
|---------------|-----------|-------------|
| Type | Order No. | Pcs. / Pkt. |
| TP 15T/M 211 | 2701845 | 1 |

| Accessories | | |
|-------------------------------|-----------|-------------|
| | Order No. | Pcs. / Pkt. |
| TOUCH PEN | 2701379 | 1 |
| 2 GB USB STICK | 2701382 | 1 |
| HMI BATTERY | 2701383 | 1 |
| HMI SCB MOUNTING KIT 8 | 2701387 | 1 |
| 10,4" DISPLAY PROTECTIVE FOIL | 2701376 | 1 |

| Accessories | | |
|-------------------------------|-----------|-------------|
| | Order No. | Pcs. / Pkt. |
| TOUCH PEN | 2701379 | 1 |
| 2 GB USB STICK | 2701382 | 1 |
| HMI BATTERY | 2701383 | 1 |
| HMI SCB MOUNTING KIT 8 | 2701387 | 1 |
| 12,1" DISPLAY PROTECTIVE FOIL | 2701377 | 1 |

| Accessories | | |
|-------------------------------|-----------|-------------|
| | Order No. | Pcs. / Pkt. |
| TOUCH PEN | 2701379 | 1 |
| 2 GB USB STICK | 2701382 | 1 |
| HMI BATTERY | 2701383 | 1 |
| HMI SCB MOUNTING KIT 8 | 2701387 | 1 |
| 15,1" DISPLAY PROTECTIVE FOIL | 2701378 | 1 |

Box PCs

Box PCs are compact and flexible. They can be used in a wide variety of applications such as measurement, control and process testing. The compact size and numerous mounting options also work well for distributed systems with remote monitors.

Features:

- High system availability thanks to a fanless design or convection booster, suitable for industrial applications and absence of moving parts
- 3rd generation of Intel® Celeron® and Core™ i7 processors
- Versatile use, thanks to various mounting options, e.g., on the DIN rail
- Large-scale compatibility with open IT standards, numerous interfaces and operating system options



Box PC for DIN rail or wall mounting

| Technical data | | | |
|--|--|----------------|-------------|
| Computer data | Processor RAM (configuration option) | | |
| Mass storage (configuration option) | | | |
| Interfaces | | | |
| Network | | | |
| Power supply unit | | | |
| General data | | | |
| Width | 162 mm | | |
| Height | 146.2 mm | | |
| Depth | 49 mm | | |
| Degree of protection | IP20 | | |
| Ambient temperature (operation) | 0°C ... 50°C | | |
| Permissible humidity (operation) | 5% ... 95% (non-condensing) | | |
| Mounting type | Wall or DIN rail | | |
| Vibration (operation) | DIN EN 60068-2-6 | | |
| Shock | 15g, 11 ms in accordance with IEC 60068-2-27 | | |
| Ordering data | | | |
| Description | Type | Order No. | Pcs. / Pkt. |
| Industrial computer - Configurable | BL BPC 2000 | 2701712 | 1 |
| Industrial computer - Preconfigured with 2 GB RAM, no mass storage or operating system - Preconfigured with 4 GB RAM, no mass storage or operating system | BL BPC 2001 | 2701711 | 1 |



Box PC for wall mounting



High-performance box PC for wall mounting

| Technical data |
|--|
| Intel® Celeron® 1020E 2.2 GHz |
| 4 GB DDR3 SODIMM |
| 8 GB DDR3 SODIMM |
| 16 GB DDR3 SODIMM |
| CompactFlash® |
| 2.5" SATA hard drive |
| 2.5" SATA solid-state drive |
| 4x USB 2.0 |
| 1x COM (RS-232/422/485) |
| 2x COM (RS-232) |
| 2x Ethernet (10/100/1000 Mbps), RJ45 |
| 24 V DC ±20% |
| 357 mm |
| 190 mm |
| 87 mm |
| IP20 |
| 0°C ... 45°C |
| 5% ... 95% (non-condensing) |
| Wall mount |
| DIN EN 60068-2-6 |
| 15g, 11 ms in accordance with IEC 60068-2-27 |

| Technical data |
|--|
| Intel® Core™ i7-3555LE 3.2 GHz |
| 4 GB DDR3 SODIMM |
| 8 GB DDR3 SODIMM |
| 16 GB DDR3 SODIMM |
| CompactFlash® |
| 2.5" SATA hard drive |
| 2.5" SATA solid-state drive |
| 4x USB 2.0 |
| 1x COM (RS-232/422/485) |
| 2x COM (RS-232) |
| 2x Ethernet (10/100/1000 Mbps), RJ45 |
| 24 V DC ±20% |
| 357 mm |
| 190 mm |
| 87 mm |
| IP20 |
| 0°C ... 45°C |
| 5% ... 95% (non-condensing) |
| Wall mount |
| DIN EN 60068-2-6 |
| 15g, 11 ms in accordance with IEC 60068-2-27 |

| Ordering data | | |
|---------------|-----------|-------------|
| Type | Order No. | Pcs. / Pkt. |
| BL BPC 3000 | 2400082 | 1 |
| BL BPC 3001 | 2400080 | 1 |

| Ordering data | | |
|---------------|-----------|-------------|
| Type | Order No. | Pcs. / Pkt. |
| BL BPC 7000 | 2400083 | 1 |
| BL BPC 7001 | 2400081 | 1 |

Panel PCs

Panel PCs combine the advantages of a modern industrial PC with the operation and monitoring functions of a touch screen monitor. Typically installed in the front of the control cabinet, they provide monitoring and control directly on site.

Features:

- High system availability thanks to a fanless design or convection booster, suitable for industrial applications and absence of moving parts
- 3rd generation of Intel® Celeron® and Core™ i7 processors
- Large-scale compatibility with open IT standards, numerous interfaces and operating system options
- Display sizes from 12 (SVGA) to 17 (SXGA) inches
- High graphic performance with Intel HD graphics 4000



Panel PC with Atom™ processor

| | |
|--|--|
| Display data | |
| Display (configuration option) | |
| Monitor resolution | |
| Brightness | |
| Display backlight MTBF | |
| Touch screen | |
| Computer data | |
| Processor (configuration option) | |
| RAM (configuration option) | |
| Mass storage (configuration option) | |
| Interfaces | |
| Network | |
| Power supply unit | |
| General data | |
| Degree of protection | |
| Ambient temperature (operation) | |
| Permissible humidity (operation) | |
| Mounting type | |
| Vibration (operation) | |
| Shock | |
| EMC note | |

| Technical data | |
|--|--|
| 30.7 cm/12.1" TFT | |
| 38.1 cm/15" TFT | |
| 43.2 cm/17"-TFT | |
| 800 x 600 pixels (SVGA) | |
| 1024 x 768 pixels (XGA) | |
| 1280 x 1024 pixels (SXGA) | |
| 350 cd/m ² , typical (adjustable) | |
| > 50000 h | |
| Resistive industrial touch screen | |
| Intel® Atom™ N455 1.66 GHz | |
| 2 GB DDR3 SODIMM | |
| CompactFlash® | |
| 2.5" SATA hard drive | |
| 2.5" SATA solid-state drive | |
| 4x USB 2.0 | |
| 1x COM (RS-232/422/485) | |
| 2x COM (RS-232) | |
| 2x Ethernet (10/100/1000 Mbps), RJ45 | |
| 24 V DC ±20% | |
| IP65 (front), IP20 (back) | |
| 0°C ... 50°C | |
| 5% ... 95% (non-condensing) | |
| Panel PC for mounting in the front panel | |
| DIN EN 60068-2-6 | |
| 15g, 11 ms in accordance with IEC 60068-2-27 | |
| Class A product, see page 443 | |

| Description |
|--|
| Industrial panel PC (PPC) with resistive touch screen. Configurable options for display size, memory and mass storage. |
| - Atom processor |
| - Celeron processor |
| - Core i7 processor |
| Industrial panel PC (PPC) with resistive touch screen. |
| - Preconfigured with 12.1-inch display, 2 GB RAM, no mass storage or operating system |
| - Preconfigured with 15-inch display, 2 GB RAM, no mass storage or operating system |
| - Preconfigured with 17-inch display, 2 GB RAM, no mass storage or operating system |
| - Preconfigured with 15-inch display, 4 GB RAM, no mass storage or operating system |
| - Preconfigured with 17-inch display, 4 GB RAM, no mass storage or operating system |

| Ordering data | | |
|----------------------|----------------|-------------|
| Type | Order No. | Pcs. / Pkt. |
| BL PPC 1000 | 2701401 | 1 |
| BL PPC12 1000 | 2701336 | 1 |
| BL PPC15 1000 | 2701338 | 1 |
| BL PPC17 1000 | 2701337 | 1 |



Panel PC with Celeron® processor



Panel PC with Core™ i7 processor

| Technical data |
|--|
| 38.1 cm/15" TFT 43.2 cm/17"-TFT |
| 1024 x 768 pixels (XGA) 1280 x 1024 pixels (SXGA) |
| 350 cd/m ² , typical (adjustable) > 50000 h Resistive industrial touch screen |
| Intel® Celeron® 1020E 2.2 GHz 4 GB DDR3 SODIMM 8 GB DDR3 SODIMM 16 GB DDR3 SODIMM CompactFlash® 2.5" SATA hard drive 2.5" SATA solid-state drive 4x USB 2.0 1x COM (RS-232/422/485) 2x COM (RS-232) 2x Ethernet (10/100/1000 Mbps), RJ45 24 V DC ±20% |
| IP65 (front), IP20 (back) 0°C ... 45°C 5% ... 95% (non-condensing) Panel PC for mounting in the front panel DIN EN 60068-2-6 15g, 11 ms in accordance with IEC 60068-2-27 Class A product, see page 443 |

| Technical data |
|---|
| 38.1 cm/15" TFT 43.2 cm/17"-TFT |
| 1024 x 768 pixels (XGA) 1280 x 1024 pixels (SXGA) |
| 350 cd/m ² , typical (adjustable) > 50000 h Resistive industrial touch screen |
| Intel® Core™ i7-3555LE 3.2 GHz 4 GB DDR3 SODIMM 8 GB DDR3 SODIMM 16 GB DDR3 SODIMM CompactFlash® 2.5" SATA hard drive 2.5" SATA solid-state drive 4x USB 2.0 1x COM (RS-232/422/485) 2x COM (RS-232) 2x Ethernet (10/100/1000 Mbps), RJ45 24 V DC ±20% |
| IP65 (front), IP20 (back) 0°C ... 45°C 5% ... 95% (non-condensing) Panel PC for mounting in the front panel DIN EN 60068-2-6 15g, 11 ms in accordance with IEC 60068-2-27 Class A product, see page 443 |

| Ordering data | | |
|---------------|-----------|-------------|
| Type | Order No. | Pcs. / Pkt. |
| BL PPC 3000 | 2701397 | 1 |
| BL PPC15 3000 | 2701393 | 1 |
| BL PPC17 3000 | 2701394 | 1 |

| Ordering data | | |
|---------------|-----------|-------------|
| Type | Order No. | Pcs. / Pkt. |
| BL PPC 7000 | 2701398 | 1 |
| BL PPC15 7000 | 2701395 | 1 |
| BL PPC17 7000 | 2701396 | 1 |

Outdoor panel PCs

The new outdoor panel PCs fit seamlessly into the existing portfolio of panel PCs. Designed for use under extreme ambient conditions, the devices meet the requirements for an extended temperature range, easily readable displays in direct sunlight, UV resistance, and a high level of mechanical and chemical resistance.

Additional features:

- Display can be read in direct sunlight
- Resistant to UV and IR radiation
- Extended temperature range
- Watertight thanks to IP67 protection
- Resistant to environmental influences, such as salt spray and termites
- Resistant to chemicals, e.g., aggressive cleaning agents, deicers for aircraft
- Can be operated when wearing work gloves



17.8 cm (7") widescreen display

| |
|-------------------------------------|
| Display data |
| Display |
| Monitor resolution |
| Display lighting type |
| Brightness |
| Display backlight MTBF |
| Touch screen |
| Computer data |
| Processor |
| RAM |
| Mass storage (configuration option) |
| Interfaces |
| Slots |
| Monitor output |
| Network |
| Power supply unit |
| General data |
| Degree of protection |
| Ambient temperature (operation) |
| Permissible humidity (operation) |
| Mounting type |
| Vibration (operation) |
| Shock |

| Technical data | |
|--|--|
| 17.8 cm/7" TFT | |
| 800 x 400 pixels (WVGA) | |
| LED | |
| 350 cd/m ² , typical (adjustable) | |
| > 50000 h | |
| Resistive industrial touch screen (GFG) | |
| Intel® Atom™ E680T 1.6 GHz | |
| 2 GB DDR2 800 | |
| Flash SSD 8 GB | |
| Flash SSD 16 GB | |
| Flash SSD 32 GB | |
| 4 x USB host 2.0 | |
| SD card | |
| Without | |
| 1 x Ethernet (10/100/1000 Mbps), RJ45 | |
| 24 V DC ±20% | |
| IP67 (front), IP20 (back) | |
| -20°C ... 65°C | |
| 20% ... 85% (non-condensing) | |
| Installation in front plate | |
| DIN EN 60068-2-6 | |
| DIN EN 60068-2-27 | |

| |
|--|
| Description |
| Panel PC for outdoor applications |

| Ordering data | | |
|-----------------|-----------|-------------|
| Type | Order No. | Pcs. / Pkt. |
| EL PPC7 1000/WT | 2400065 | 1 |



30.5 cm (12.1") display



38.1 cm (15") display

| Technical data |
|--|
| 30.7 cm/12.1" TFT |
| 800 x 600 pixels (SVGA) |
| LED |
| 350 cd/m ² , typical (adjustable) |
| > 50000 h |
| Resistive industrial touch screen (GFG) |
| Intel® Atom™ E680T 1.6 GHz |
| 2 GB DDR2 800 |
| Flash SSD 8 GB |
| Flash SSD 16 GB |
| Flash SSD 32 GB |
| 4 x USB host 2.0 |
| SD card |
| Without |
| 1 x Ethernet (10/100/1000 Mbps), RJ45 |
| 24 V DC ±20% |
| IP67 (front), IP20 (back) |
| -20°C ... 65°C |
| 20% ... 85% (non-condensing) |
| Installation in front plate |
| DIN EN 60068-2-6 |
| DIN EN 60068-2-27 |

| Technical data |
|--|
| 38.1 cm/15" TFT |
| 1024 x 768 pixels (XGA) |
| LED |
| 350 cd/m ² , typical (adjustable) |
| > 50000 h |
| Resistive industrial touch screen (GFG) |
| Intel® Atom™ E680T 1.6 GHz |
| 2 GB DDR2 800 |
| Flash SSD 8 GB |
| Flash SSD 16 GB |
| Flash SSD 32 GB |
| 4 x USB host 2.0 |
| SD card |
| Without |
| 1 x Ethernet (10/100/1000 Mbps), RJ45 |
| 24 V DC ±20% |
| IP67 (front), IP20 (back) |
| -20°C ... 65°C |
| 20% ... 85% (non-condensing) |
| Installation in front plate |
| DIN EN 60068-2-6 |
| DIN EN 60068-2-27 |

| Ordering data | | |
|------------------|-----------|-------------|
| Type | Order No. | Pcs. / Pkt. |
| EL PPC12 1000/WT | 2400066 | 1 |

| Ordering data | | |
|------------------|-----------|-------------|
| Type | Order No. | Pcs. / Pkt. |
| EL PPC15 1000/WT | 2400067 | 1 |

HMIs and industrial PCs - industrial PCs

IP65 panel PCs

Designline 7000 IPCs are powerful panel PCs that utilize Intel® Core™ i7 processors. The fanless design and completely enclosed IP65 housing makes the Designline 7000 suitable for demanding industrial applications. VESA 100 mounting allows installation directly on a machine or system for an integrated, attractive appearance.

Features:

- 4th generation Intel Core i7 processors
- Projected capacitive touch screen (PCT)
- 15-inch XGA to 21.5-inch displays with Intel HD graphics 5000
- Fanless for clean, quiet operation
- Slim, attractive design
- All-in-one, IP65-rated design
- Conforms to VESA MIS-D, 100 mounting standard

Notes:
 1) Configuration options can affect the operating temperature. See data sheet for details.



Fully enclosed IP65 IPC with 38.1 cm (15") display

| | |
|-------------------------------------|---|
| Display data | |
| Display | 38.1 cm/15" TFT |
| Monitor resolution | 1024 x 768 pixels (XGA) |
| Display lighting type | LED |
| Brightness | 400 cd/m ² , typical (adjustable) |
| Display backlight MTBF | > 50000 h |
| Touch screen | Capacitive multi-touch screen |
| Computer data | |
| Processor | Intel®Core™ i7-4650U 3.30 GHz |
| RAM (configuration option) | 4 GB DDR3 8 GB DDR3 12 GB DDR3 |
| Mass storage (configuration option) | 2.5" SATA hard drive 2.5" SATA solid-state drive |
| Interfaces | |
| Network | 4x USB 2.0, 1x USB 3.0 1x COM (RS-232/422/485) 1x Audio 2x Ethernet (10/100/1000 Mbps), RJ45 |
| Power supply unit | 24 V DC ±20% |
| General data | |
| Degree of protection | IP65 |
| Ambient temperature (operation) | 0°C ... 45°C ¹⁾ |
| Permissible humidity (operation) | 5% ... 95% (non-condensing) |
| Mounting type | VESA MIS-D (100 x 100) |
| Vibration (operation) | 1g with SSD, 0.5g with HDD, according to EN 60068-2-6 |
| Shock | 15g, 11 ms in accordance with IEC 60068-2-27 |

Technical data

| | | |
|---|--|--|
| Technical data | | |
| 38.1 cm/15" TFT | | |
| 1024 x 768 pixels (XGA) | | |
| LED | | |
| 400 cd/m ² , typical (adjustable) | | |
| > 50000 h | | |
| Capacitive multi-touch screen | | |
| Intel®Core™ i7-4650U 3.30 GHz | | |
| 4 GB DDR3 | | |
| 8 GB DDR3 | | |
| 12 GB DDR3 | | |
| 2.5" SATA hard drive | | |
| 2.5" SATA solid-state drive | | |
| 4x USB 2.0, 1x USB 3.0 | | |
| 1x COM (RS-232/422/485) | | |
| 1x Audio | | |
| 2x Ethernet (10/100/1000 Mbps), RJ45 | | |
| 24 V DC ±20% | | |
| IP65 | | |
| 0°C ... 45°C ¹⁾ | | |
| 5% ... 95% (non-condensing) | | |
| VESA MIS-D (100 x 100) | | |
| 1g with SSD, 0.5g with HDD, according to EN 60068-2-6 | | |
| 15g, 11 ms in accordance with IEC 60068-2-27 | | |

| |
|--|
| Description |
| High performance IPC with touch screen and IP65 housing |
| - 38.1 cm (15") display |
| - 47 cm (18.5") display |
| - 54.6 cm (21.5") display |

Ordering data

| Type | Order No. | Pcs. / Pkt. |
|----------------|-----------|-------------|
| DL PPC15M 7000 | 2400017 | 1 |



Fully enclosed IP65 IPC with 47 cm (18.5") display



Fully enclosed IP65 IPC with 54.6 cm (21.5") display

| Technical data |
|---|
| 47 cm/18,5" TFT |
| 1366 x 768 pixels (WXGA) |
| LED |
| 300 cd/m ² , typical (adjustable) |
| > 50000 h |
| Capacitive multi-touch screen |
| Intel®Core™ i7-4650U 3.30 GHz |
| 4 GB DDR3 |
| 8 GB DDR3 |
| 12 GB DDR3 |
| 2.5" SATA hard drive |
| 2.5" SATA solid-state drive |
| 4x USB 2.0, 1x USB 3.0 |
| 1x COM (RS-232/422/485) |
| 1x Audio |
| 2x Ethernet (10/100/1000 Mbps), RJ45 |
| 24 V DC ±20% |
| IP65 |
| 0°C ... 45°C ¹⁾ |
| 5% ... 95% (non-condensing) |
| VESA MIS-D (100 x 100) |
| 1g with SSD, 0.5g with HDD, according to EN 60068-2-6 |
| 15g, 11 ms in accordance with IEC 60068-2-27 |

| Technical data |
|---|
| 54.6 cm/21,5" TFT |
| 1920 x 1080 pixels (Full HD) |
| LED |
| 300 cd/m ² , typical (adjustable) |
| > 50000 h |
| Capacitive multi-touch screen |
| Intel®Core™ i7-4650U 3.30 GHz |
| 4 GB DDR3 |
| 8 GB DDR3 |
| 12 GB DDR3 |
| 2.5" SATA hard drive |
| 2.5" SATA solid-state drive |
| 4x USB 2.0, 1x USB 3.0 |
| 1x COM (RS-232/422/485) |
| 1x Audio |
| 2x Ethernet (10/100/1000 Mbps), RJ45 |
| 24 V DC ±20% |
| IP65 |
| 0°C ... 45°C ¹⁾ |
| 5% ... 95% (non-condensing) |
| VESA MIS-D (100 x 100) |
| 1g with SSD, 0.5g with HDD, according to EN 60068-2-6 |
| 15g, 11 ms in accordance with IEC 60068-2-27 |

| Ordering data | | |
|------------------|-----------|-------------|
| Type | Order No. | Pcs. / Pkt. |
| DL PPC18.5M 7000 | 2400015 | 1 |

| Ordering data | | |
|------------------|-----------|-------------|
| Type | Order No. | Pcs. / Pkt. |
| DL PPC21.5M 7000 | 2400016 | 1 |



Extend your system visualization to smartphones or tablets with the **Visu+ mobile** visualization app from Phoenix Contact. You can design flexible operating and monitoring concepts, as the Visu+ mobile app allows you to access your system at any time and from any location.

Integrate Visu+ mobile quickly and easily in existing touch panel or industrial PC visualization solutions. The Visu+ web server required for the app is already pre-installed in numerous devices from Phoenix Contact, such as touch panels. IPCs with Visu+ simply need to be extended with the web license option.

You can conveniently download the app in the usual way from the Google Play Store for Android or the App Store for Apple devices.

Features:

- Familiar comfort: simply use conventional smartphones or tablets to perform operation and monitoring
- Conventional SCADA functions such as trend display or alarm handling now also available on mobile devices
- Easy installation via Google Play store or App store
- High-performance, scalable Visu+ web server: up to 100 clients can be operated simultaneously in its maximum configuration
- Convenient generation of HTML visualization pages for the Visu+ web server from the Visu+ development environment



Easy app installation via Google Play store or Apple app store

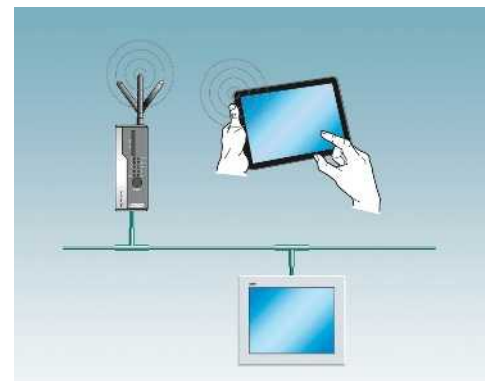

Visu+ mobile on a mobile termination device via access point, with a touch panel and web server

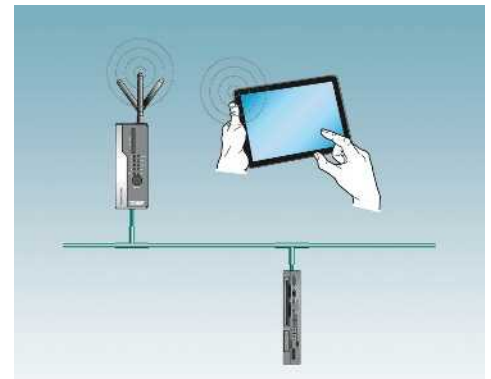

Visu+ mobile on a mobile termination device via access point, with an industrial PC and web server

Multiplexer function for retrofitting

With the software for multiplexer systems, you can create a multiplexer system from two ILC 131 ETH small-scale controllers. Without any time-consuming programming.

To do so, extend each small-scale controller with an SD FLASH 512MB MODULAR MUX SD card and the corresponding I/O panel. Configuration is easy with few wire bridges - you just need to define the master and slave.

The software is therefore ideal for all areas of application where a multiplexer solution is required, without additional programming work for the controller.

- Wireless, Ethernet cable or network connection
- Multiplexer solution with standard components (2x ILC 131 ETH and 2x SD FLASH 512MB MODULAR MUX)
- Integration in Ethernet network via web interface, with PC and standard browser

Notes:

When ordering, please note that you require two controllers and two SD cards respectively.



Technical data

See phoenixcontact.net/products

Ordering data

| Description | Type | Order No. | Pcs. / Pkt. |
|---|----------------------------|-----------|-------------|
| Multiplexer application on SD card for configuring two ILC 131 ETH controllers as a multiplexer | SD FLASH 512MB MODULAR MUX | 2701872 | 1 |

Logic modules

Minimal effort with maximum benefits – for Nanoline programmable logic modules the focus is on simplicity and flexibility. This means a modular and adaptable design with optimum networking options.

Your advantages:

- Save time – by intelligently controlling basic tasks
- Easy use without prior knowledge, thanks to intuitive programming
- Versatile communication with numerous integration and networking options
- Maximum flexibility, thanks to the modular design

Additional features:

- Two high-speed counters and two analog inputs
- Supports four mathematical functions
- Integrated digital I/O
- Add an additional digital I/O extension module for a maximum of 12 I/O points
- Support for large Nanoline operator panel
- Integrated realtime clock (RTC)
- Integrated RS-232 for connection to a PC for programming and configuration
- Integrated RS-232 and RS-485 allow you to use your logic module as a Modbus RTU server
- Flexible programming with nanoNavigator or LOGIC+

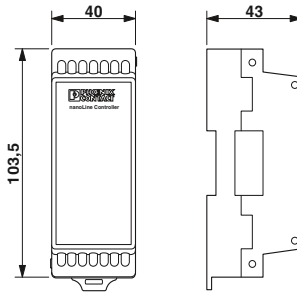

24 V DC, 4 digital inputs and 2 relay outputs

| | |
|--|----------------------------|
| Power supply | |
| Supply voltage | |
| Supply voltage range | 19.2 V DC ... 30 V DC |
| Typical current consumption | 74 mA |
| Max. current consumption | 81 mA |
| Digital inputs | |
| Number of inputs | 4 |
| Description of the inputs | PNP |
| Typical response time | 10 µs (channel 1 and 2) |
| Digital outputs | |
| Number of outputs | 2 |
| Description of the outputs | Relay output |
| Maximum output current per channel | 5 A |
| Maximum output current per module / terminal block | 10 A |
| Software interfaces | |
| Programming tool | nanoNavigator 4.2 or above |
| General data | |
| Connection method | Screw connection |
| Degree of protection | IP20 |
| Ambient temperature (operation) | -25°C ... 70°C |

| Technical data | |
|---|----------------------------|
| NLC-035-024D 041-02QRD-05A | NLC-040-024D-041-02QRD-05A |
| 24 V DC (power available to the I/O and Communications modules) | |
| 19.2 V DC ... 30 V DC | |
| 74 mA | |
| 81 mA | |
| 4 | |
| PNP | |
| 10 µs (channel 1 and 2) | |
| 2 | |
| Relay output | |
| 5 A | |
| 10 A | |
| nanoNavigator 4.2 or above | LOGIC+ |
| Screw connection | |
| IP20 | |
| -25°C ... 70°C | |

| | |
|---|--|
| Description | |
| Nanoline controller | |
| - Programmable with nanoNavigator 4.2 and above | |
| - Programmable with LOGIC+ | |

| Ordering data | | |
|----------------------------|-----------|-------------|
| Type | Order No. | Pcs. / Pkt. |
| NLC-035-024D 041-02QRD-05A | 2702031 | 1 |
| NLC-040-024D-041-02QRD-05A | 2400079 | 1 |

| | |
|---------------------------|--|
| Programming cable | |
| - 9-pos. D-SUB to RJ11/12 | |

| Accessories | | |
|----------------------|-----------|-------------|
| Type | Order No. | Pcs. / Pkt. |
| NLC-PC/SERIAL-CBL 1M | 2701234 | 1 |

Large operator panel

The operator panel is your interface for interacting with the Nanoline system. Read the status of all I/O points, registers, timers, counters, and system flags directly. In addition, the application program sends prompts and instructions to the display. The operator panel offers numerical (0-9), directional (up, down, left, right), and input keys. In addition, each of the 14 keys on the operator panel can be used to create user-specific menus in a flow chart.

Additional features:

- 76 mm diagonal screen
- Variable text sizes for enhanced readability of custom messages (4 x 20 or 2 x 10 or a combination)
- Cable length of up to 15 m allows remote mounting away from the logic module
- External 24 V DC
- Variable backlight: red, blue or green
- Adjustable backlight timer to save energy



User interface for Nanoline controllers

| Technical data | | | |
|--|--|-----------|-------------|
| Display data | Backlit LC display, monochrome, 4 lines with 20 characters or 2 lines with 10 characters | | |
| Display | | | |
| Interfaces | 9-pos. D-SUB male | | |
| Operator panel | Max. 15 m | | |
| Transmission length | | | |
| Power supply for module electronics | 24 V DC | | |
| Supply voltage | 3-pos. Combicon | | |
| Connection method | 38 mA (24 V DC) | | |
| Typical current consumption | 40 mA (24 V DC) | | |
| Max. current consumption | | | |
| General data | | | |
| Programming tool | nanoNavigator | | |
| Mounting type | Panel mounting | | |
| Keys | 17 | | |
| Height | 102 mm | | |
| Width | 128 mm | | |
| Depth | 44.5 mm | | |
| Degree of protection | IP66 | | |
| Ambient temperature (operation) | 0°C ... 50°C | | |
| Ambient temperature (storage/transport) | 0°C ... 60°C | | |
| Ordering data | | | |
| Description | Type | Order No. | Pcs. / Pkt. |
| Operator panel | NLC-OP2-LCD-076-4X20 | 2701945 | 1 |
| Accessories | | | |
| Base module for remote mounting Operator Panel (included in nLC-OP1-MKT) | NLC-OP1-MKT-BASE | 2701250 | 1 |
| D-SUB plug, with two cable entries, universal type, pin assignment 1,2,3,4,5,6,7,8,9 on every screw terminal block | SUBCON-PLUS-M/AX 9 | 2904467 | 1 |

Analog I/O extension module

Temperature extension module provides RTD and thermocouple inputs as well as four digital outputs.

- Two temperature sensor inputs
- Configuration options for PT100 and PT1000 RTD sensors with two or three wires
- Configuration options for thermocouple types B, E, J, K, N, R, S, and T
- Four PNP digital outputs
- Automatically recognized by nanoNavigator

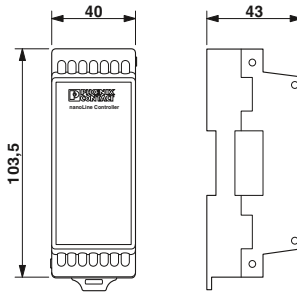

2 temperature inputs, 4 PNP outputs

| | |
|--|------------------------|
| Power supply for module electronics | |
| Supply voltage | 24 V |
| Temperature input | |
| Connection method | 2 or 3-wire (shielded) |
| Number of inputs | 2 |
| Sensor types (RTD) that can be used | Pt 100, Pt 1000 |
| Sensor types that can be used (TC) | B, E, J, K, N, R, S, T |
| Digital outputs | |
| Number of outputs | 4 |
| Description of the outputs | PNP outputs |
| Nominal output voltage | 24 V DC |
| Maximum output current per channel | 0.5 A |
| Maximum output current per module / terminal block | 2 A |
| Maximum switching voltage | 24 V DC |
| Minimum switching voltage | 0.8 V DC |
| General data | |
| Connection method | Screw connection |
| Ambient temperature (operation) | 0°C ... 60°C |

Technical data

| | |
|--|--|
| Description | |
| Nanoline controllers, I/O extension module | |
| - 2 temperature inputs, 4 PNP outputs | |

Ordering data

| Type | Order No. | Pcs. / Pkt. |
|--------------------------|-----------|-------------|
| NLC-IO-2RTD/UTH-4QTP-01A | 2701671 | 1 |

Digital I/O extension module for NLC-035 and NLC-040 logic modules

You can extend your Nanoline with an additional I/O extension module. Extension modules provide additional inputs and outputs beyond what is available on the logic module.

- The NLC-IOX is only compatible with the NLC-035 and NLC-040
- One module can be added to the right side of a logic module
- Automatically recognized by nanoNavigator

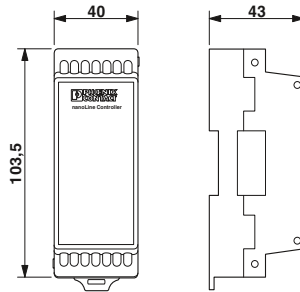

Digital I/O extension module

| |
|--|
| Power supply for module electronics |
| Supply voltage |
| Digital inputs |
| Maximum number of inputs |
| Description of the inputs |
| Digital outputs |
| Number of outputs |
| Description of the outputs |
| Maximum output current per channel |
| Maximum output current per module / terminal block |

Technical data

| | |
|--|--------------|
| Supply voltage | 24 V DC |
| Maximum number of inputs | 4 |
| Description of the inputs | PNP |
| Number of outputs | 2 |
| Description of the outputs | Relay output |
| Maximum output current per channel | 5 A |
| Maximum output current per module / terminal block | 10 A |

| |
|---|
| Description |
| Nanoline controllers, I/O extension module |
| - 4 digital inputs, 2 relay outputs |

Ordering data

| Type | Order No. | Pcs. / Pkt. |
|-----------------------|-----------|-------------|
| NLC-IOX-041-02QRD-05A | 2702032 | 1 |

Index

Alphabetical

| Type | Order No. | Page | Type | Order No. | Page | Type | Order No. | Page | Type | Order No. | Page |
|-------------------------------|-----------|------|----------------------|-----------|------|----------------------------|-----------|------|--------------------------------|-----------|------|
| 1 | | | A-INL-NPT3/8-P-BK | 1411236 | 228 | | | | CP-QPD | 1582459 | 195 |
| | | | A-INL-NPT3/8-P-GY | 1411231 | 227 | | | | CP-QPD 5X2.5 | 1404530 | 195 |
| | | | A-INL-PG11-N-S | 1411257 | 230 | B | | | CRIMPF0X 10S CUS | 1212764 | 301 |
| | | | A-INL-PG11-P-GY | 1411223 | 226 | | | | CRIMPF0X 25R CUS | 1212765 | 299 |
| 10.4" DISPLAY PROTECTIVE FOIL | 2701376 | 419 | A-INL-PG13.5-N-S | 1411259 | 230 | BATTERY MOUNTING CASE | 2320458 | 320 | CRIMPF0X 50R CUS | 1212766 | 299 |
| 12.1" DISPLAY PROTECTIVE FOIL | 2701377 | 419 | A-INL-PG13.5-P-GY | 1411224 | 226 | BL BPC 2000 | 2701712 | 420 | CRIMPF0X 6 CUS | 1212767 | 299 |
| 15.1" DISPLAY PROTECTIVE FOIL | 2701378 | 419 | A-INL-PG16-N-S | 1411260 | 230 | BL BPC 2001 | 2701711 | 420 | CRIMPF0X 6H CUS | 1212768 | 301 |
| | | | A-INL-PG16-P-GY | 1411225 | 226 | BL BPC 3000 | 2400082 | 421 | CRIMPF0X 6S-F CUS | 1212769 | 299 |
| | | | A-INL-PG21-N-S | 1411262 | 230 | BL BPC 3001 | 2400080 | 421 | CRIMPF0X 6T CUS | 1212770 | 299 |
| 2 | | | A-INL-PG21-P-GY | 1411226 | 226 | BL BPC 7000 | 2400083 | 421 | CRIMPF0X 6T-F CUS | 1212771 | 299 |
| | | | A-INL-PG29-N-S | 1411263 | 230 | BL BPC 7001 | 2400081 | 421 | CRIMPF0X-1,6/2.5-ED-4.0 | 1687419 | 185 |
| 2 GB USB STICK | 2701382 | 418 | A-INL-PG29-P-GY | 1411227 | 226 | BL PPC 1000 | 2701401 | 422 | CRIMPF0X-RC 10 CUS | 1212776 | 301 |
| | | | A-INL-PG36-N-S | 1411264 | 230 | BL PPC 3000 | 2701397 | 423 | CRIMPF0X-RC 2.5 CUS | 1212777 | 299 |
| | | | A-INL-PG36-P-GY | 1411228 | 226 | BL PPC 7000 | 2701398 | 423 | CRIMPF0X-RC 25 CUS | 1212778 | 301 |
| | | | A-INL-PG42-N-S | 1411265 | 230 | BL PPC12 1000 | 2701336 | 422 | CRIMPF0X-RC1 1 CUS | 1212772 | 299 |
| | | | A-INL-PG42-P-GY | 1411229 | 226 | BL PPC15 1000 | 2701338 | 422 | CRIMPF0X-RC1 2.5 CUS | 1212773 | 299 |
| | | | A-INL-PG48-N-S | 1411266 | 230 | BL PPC15 3000 | 2701393 | 423 | CRIMPF0X-RC1 6 CUS | 1212774 | 299 |
| 7 | | | A-INL-PG48-P-GY | 1411230 | 226 | BL PPC15 7000 | 2701395 | 423 | CRIMPF0X-RC1 6-1 CUS | 1212775 | 299 |
| | | | A-INL-PG7-N-S | 1411255 | 230 | BL PPC17 1000 | 2701337 | 422 | CRIMPF0X-SC 1.5 CUS | 1212779 | 299 |
| 7" DISPLAY PROTECTIVE FOIL | 2701374 | 418 | A-INL-PG7-P-GY | 1411221 | 226 | BL PPC17 3000 | 2701394 | 423 | CRIMPF0X-SC 6 CUS | 1212780 | 301 |
| | | | A-INL-PG9-N-S | 1411256 | 230 | BL PPC17 7000 | 2701396 | 423 | CSMA-LAMBDA/4-2.0-BS-SET | 2800491 | 394 |
| | | | A-INL-PG9-P-GY | 1411222 | 226 | | | | CUC-IND-C1ZNI-B/R4QE8 | 1406336 | 44 |
| | | | A-INLE-M12-N-S | 1411267 | 232 | | | | CUC-IND-C1ZNI-B/R4QE8:30 | 1406354 | 44 |
| | | | A-INLE-M16-N-S | 1411268 | 232 | | | | CUC-IND-C1ZNI-B/R4QP8 | 1406337 | 44 |
| | | | A-INLE-M20-N-S | 1411269 | 232 | | | | CUC-IND-C1ZNI-B/R4QP8:30 | 1406355 | 44 |
| A | | | A-INLE-M25-N-S | 1411270 | 232 | | | | CUC-IND-C1ZNI-S/R4QE8 | 1406333 | 44 |
| | | | A-INLE-M32-N-S | 1411271 | 232 | | | | CUC-IND-C1ZNI-S/R4QE8:30 | 1406351 | 44 |
| | | | A-INLE-M40-N-S | 1411272 | 232 | | | | CUC-IND-C1ZNI-S/R4QP8 | 1406334 | 44 |
| A-EXB-20-66L-N-S | 1411117 | 237 | A-INLE-M50-N-S | 1411273 | 232 | C-FCI 1,5/M3 | 3240032 | 96 | CUC-IND-C1ZNI-S/R4QP8:30 | 1406352 | 44 |
| A-EXB-20-66L-S-S | 1411118 | 237 | A-INLE-M63-N-S | 1411274 | 232 | C-FCI 2,5/M3 | 3240037 | 96 | CUC-IND-C1ZNI-T/R4QE8 | 1406339 | 45 |
| A-EXB-25-66L-N-S | 1411120 | 237 | A-INLE-PG11-N-S | 1411277 | 233 | C-RC1 1,5/M3 | 3240016 | 96 | CUC-IND-C1ZNI-T/R4QE8:30 | 1406357 | 45 |
| A-EXB-25-66L-S-S | 1411121 | 237 | A-INLE-PG13,5-N-S | 1411278 | 233 | C-RC1 2,5/M3 | 3240021 | 96 | CUC-IND-C1ZNI-T/R4QP8 | 1406340 | 45 |
| A-EXSH-M20-68L-N-S | 1411104 | 236 | A-INLE-PG16-N-S | 1411279 | 233 | CAB-USB A/MICRO USB B/2,0M | 2701626 | 358 | CUC-IND-C1ZNI-T/R4QP8:30 | 1406358 | 45 |
| A-EXSH-M20-68L-S-S | 1411105 | 236 | A-INLE-PG21-N-S | 1411280 | 233 | CABLE-USB/MINI-USB-3,0M | 2986135 | 394 | CUC-PP-FRAME-19 | 1407986 | 50 |
| A-EXSH-M25-68L-N-S | 1411107 | 236 | A-INLE-PG29-N-S | 1411281 | 233 | CARRIER-EMP (27X15) | 0827451 | 254 | CUC-PP-FRAME-19 BK | 1409140 | 50 |
| A-EXSH-M25-68L-S-S | 1411108 | 236 | A-INLE-PG36-N-S | 1411282 | 233 | CARRIER-EMP (49X15) | 0827452 | 254 | CUC-PP-MODUL-COVER | 1407988 | 50 |
| A-EXSH-M32-68L-N-S | 1411109 | 236 | A-INLE-PG7-N-S | 1411275 | 233 | CARRIER-EMP (60X15) | 0827453 | 254 | CUC-PP-MODUL-RJ45:6-RJ45:6/... | 1407995 | 50 |
| A-EXSH-M32-68L-S-S | 1411110 | 236 | A-INLE-PG9-N-S | 1411276 | 233 | CARRIER-EMP (60X30) | 0827454 | 254 | CUC-PP-PATCHBAY | 1407994 | 50 |
| A-EXSH-M40-68L-N-S | 1411111 | 236 | A-SEW-20-P-W | 1411283 | 238 | CARRIER-EMP (85,6X54) | 0829365 | 254 | CUC-PP-PATCHBAY-MH | 1409283 | 50 |
| A-EXSH-M40-68L-S-S | 1411112 | 236 | A-SEW-25-P-W | 1411284 | 238 | CARRIER-EMP 22 (27X15) | 0827447 | 254 | CUC-PP-PATCHBAY-MH BK | 1409284 | 50 |
| A-EXSH-M50-68L-N-S | 1411113 | 236 | A-SEW-32-P-W | 1411285 | 238 | CARRIER-EMP 22 (27X18) | 0827448 | 254 | CUC-V14-C1ZNI-B/R4IE8 | 1408011 | 47 |
| A-EXSH-M50-68L-S-S | 1411114 | 236 | A-SEW-40-P-W | 1411286 | 238 | CARRIER-PMP (108X38) | 0830958 | 285 | CUC-V14-C1ZNI-B/R4IE8:10 | 1467804 | 47 |
| A-EXSH-M63-68L-N-S | 1411115 | 236 | A-SEW-50-P-W | 1411287 | 238 | CB RC BRIDGE | 2801616 | 321 | CUC-V14-C1ZNI-B/R4IP8 | 1407895 | 47 |
| A-EXSH-M63-68L-S-S | 1411116 | 236 | A-SEW-63-P-W | 1411288 | 238 | CB S-BE | 2905067 | 321 | CUC-V14-C1ZNI-B/R4IP8:10 | 1408046 | 47 |
| A-INL-M12-N-S | 1411240 | 229 | AI 1,0-8 RD-S | 1212523 | 294 | CES-B16-8XSRC-BK | 1411073 | 222 | CUC-V14-C1ZNI-B/SJFG:10 | 1408056 | 49 |
| A-INL-M12-P-BK | 1411213 | 225 | AI 1,0-8 YE-S | 1212782 | 294 | CES-B24-10XSRC-BK | 1411074 | 222 | CUC-V14-C1ZNI-S/R4IE8 | 1407890 | 46 |
| A-INL-M12-P-GY | 1411205 | 224 | AI 1,5-8 BK-S | 1212524 | 295 | CES-SFFS-H | 0801728 | 222 | CUC-V14-C1ZNI-S/R4IE8:10 | 1467901 | 46 |
| A-INL-M16-N-S | 1411241 | 229 | AI 1,5-8 RD-S | 1212781 | 295 | CF CRIMPHANDY 1,0 | 1212465 | 294 | CUC-V14-C1ZNI-S/R4IP8 | 1407889 | 46 |
| A-INL-M16-P-BK | 1411214 | 225 | ALU-SB | 1404531 | 195 | CF CRIMPHANDY 1,5 | 1212466 | 295 | CUC-V14-C1ZNI-S/R4IP8:10 | 1408039 | 46 |
| A-INL-M16-P-GY | 1411206 | 224 | AP RSC-T | 3059139 | 101 | CF CRIMPHANDY/ACCU | 1212518 | 294 | CUC-V14-C1ZNI-T/R4IE8 | 1468007 | 46 |
| A-INL-M20-N-S | 1411242 | 229 | AP-FTP | 3069899 | 101 | CF CRIMPHANDY/CHARGER | 1212519 | 294 | CUC-V14-C1ZNI-T/R4IE8:10 | 1467807 | 46 |
| A-INL-M20-P-BK | 1411215 | 225 | AP-ME | 3034361 | 101 | CK2,5-ED-0,50BU AG | 1663640 | 199 | CUC-V14-C1ZNI-T/R4IP8 | 1408027 | 46 |
| | | | METER | | | | | | | | |
| | | | METER | | | | | | | | |
| A-INL-M20-P-GY | 1411207 | 224 | APH-ME | 3034374 | 101 | CK2,5-ED-0,50BU AU | 1674859 | 199 | CUC-V14-C1ZNI-T/R4IP8:10 | 1408092 | 46 |
| A-INL-M20-S-S | 1411249 | 238 | APH-UTWE 6-2 | 3069057 | 101 | CK2,5-ED-0,50ST AG | 1663572 | 199 | CUC-V14-C1ZNI-T/SJFG:10 | 1408095 | 48 |
| A-INL-M25-N-S | 1411243 | 229 | APT-ME | 3034358 | 93 | CK2,5-ED-0,50ST AU | 1674804 | 199 | CUTFOX-ES | 1212621 | 222 |
| A-INL-M25-P-BK | 1411216 | 225 | ATP-QTC QUATTRO | 3206225 | 173 | CK2,5-ED-0,75ST AG | 1663585 | 199 | | | |
| | | | | | | CK2,5-ED-1,00BU AG | 1663666 | 199 | | | |
| A-INL-M25-P-GY | 1411208 | 224 | ATP-QTC TWIN | 3206212 | 172 | CK2,5-ED-1,00BU AG | 1674833 | 199 | | | |
| A-INL-M25-S-S | 1411250 | 238 | ATP-ST QUATTRO | 3030815 | 157 | CK2,5-ED-1,00ST AG | 1663598 | 199 | | | |
| A-INL-M32-N-S | 1411244 | 229 | ATP-ST-TWIN | 3030789 | 156 | CK2,5-ED-1,00ST AU | 1674781 | 199 | D-PT 1,5/S-MT-0,8 | 3210303 | 156 |
| A-INL-M32-P-BK | 1411217 | 225 | ATP-STTB 4 | 3030747 | 157 | CK2,5-ED-1,50BU AG | 1663608 | 199 | D-PT 1,5/S-MT-0,8 OG | 3210304 | 156 |
| | | | | | | CK2,5-ED-1,50BU AU | 1674820 | 199 | D-PT 1,5/S-QUATTRO-MT-0,8 | 3210333 | 157 |
| A-INL-M32-P-GY | 1411209 | 224 | ATP-UK | 3003224 | 170 | CK2,5-ED-1,50ST AG | 1663608 | 199 | D-PT 1,5/S-QUATTRO-MT-0,8 OG | 3210334 | 157 |
| A-INL-M32-S-S | 1411251 | 238 | ATP-UT-TWIN | 3047183 | 162 | CK2,5-ED-1,50ST AU | 1674778 | 199 | D-PT 1,5/S-TWIN-MT-0,8 | 3210313 | 157 |
| A-INL-M40-N-S | 1411246 | 229 | AXL BS BK | 2701422 | 408 | CK2,5-ED-2,50BU AG | 1663682 | 199 | D-PTT 2,5-2MT-0,8 OG | 3210314 | 157 |
| A-INL-M40-P-BK | 1411218 | 225 | AXL F A14 1 1H | 2688491 | 412 | CK2,5-ED-2,50BU AU | 1674862 | 199 | D-PTT 1,5/S-2MT-0,8 | 3210353 | 157 |
| | | | | | | CK2,5-ED-2,50ST AG | 1663611 | 199 | D-PTT 1,5/S-2MT-0,8 OG | 3210354 | 157 |
| A-INL-M40-P-GY | 1411210 | 224 | AXL F A14 U 1H | 2688501 | 411 | CK2,5-ED-2,50ST AU | 1674817 | 199 | D-PTT 2,5-2MT-0,8 | 3210300 | 158 |
| A-INL-M40-S-S | 1411252 | 238 | AXL F AO4 1H | 2688527 | 413 | CK2,5-ED-4,00BU AG | 1663705 | 199 | D-PTT 2,5-2MT-0,8 OG | 3210299 | 158 |
| A-INL-M50-N-S | 1411247 | 229 | AXL F BK PN | 2701815 | 409 | CK2,5-ED-4,00BU AU | 1674846 | 199 | D-PTTB 2,5-2MTB | 3210404 | 160 |
| A-INL-M50-P-BK | 1411219 | 225 | AXL F BK S3 | 2701686 | 408 | CK2,5-ED-4,00ST AG | 1663637 | 199 | D-QTC 2,5-QUATTRO | 3206449 | 173 |
| | | | | | | CK2,5-ED-4,00ST AU | 1674794 | 199 | | | |
| A-INL-M50-P-GY | 1411211 | 224 | AXL F BS H | 2700992 | 410 | CK2,5-M-2,5 AG | 1409207 | 77 | D-QTC 2,5-TWIN-MT | 3050511 | 172 |
| A-INL-M50-S-S | 1411253 | 238 | AXL F D18/1 DO8/1 1H | 2701916 | 410 | CK2,5-M-4 AG | 1409208 | 77 | D-UK 4-SD | 3246862 | 170 |
| A-INL-M63-N-S | 1411248 | 229 | AXL F PSD18/4 1F | 2701559 | 404 | CK2,5-M-6 AG | 1409209 | 77 | D-UTT 2,5/4 | 3044676 | 164 |
| A-INL-M63-P-BK | 1411220 | 225 | AXL F PSD08/3 1F | 2701560 | 405 | | | | DL PPC15M 7000 | 2400017 | 426 |
| | | | | | | | | | | | |
| A-INL-M63-P-GY | 1411212 | 224 | AXL F RTD4 1H | 2688556 | 414 | CLIP-PROJECT ADVANCED | 5146040 | 291 | DL PPC18.5M 7000 | 2400015 | 427 |
| A-INL-M63-S-S | 1411254 | 238 | AXL F UTH4 1H | 2688598 | 415 | CLIP-PROJECT PROFESSIONAL | 5146053 | 291 | DL PPC21.5M 7000 | 2400016 | 427 |
| A-INL-NPT1-P-BK | 1411239 | 228 | AXL SHIELD SET | 2700518 | 411 | CP-DMC 1,5-THR NAT | 1790647 | 35 | DMET 5X20 | 3032075 | 168 |
| A-INL-NPT1-P-GY | 1411235 | 227 | | | | CP-HC-S | 1410916 | 221 | DP-UTT 2,5/4 | 3044677 | 164 |
| A-INL-NPT1/2-P-BK | 1411237 | 228 | | | | | | | | | |
| A-INL-NPT1/2-P-GY | 1411233 | 227 | | | | | | | | | |
| A-INL-NPT3/4-P-BK | 1411238 | 228 | | | | | | | | | |
| A-INL-NPT3/4-P-GY | 1411234 | 227 | | | | | | | | | |

| Type | Order No. | Page | Type | Order No. | Page | Type | Order No. | Page | Type | Order No. | Page |
|---------------|-----------|------|--------------------------------|-----------|------|--------------------------|-----------|------|---------------------------|-----------|------|
| DS-QTC 2.5 | 3206607 | 173 | FBP-2/A7 | 3069497 | 103 | FOC-V14-C1ZNI-B/SJFH | 1407904 | 49 | G-EDSWU-M40-L66L-STES-S | 1411099 | 235 |
| DT-TELE-SHDSL | 2801593 | 314 | FBP-2/B14 | 3069501 | 111 | FOC-V14-C1ZNI-B/SJFH:10 | 1408055 | 49 | G-EDSWU-M50-L66L-STES-S | 1411101 | 235 |
| | | | FBP-2/B19 | 3069503 | 115 | FOC-V14-C1ZNI-B/SJFH | 1407902 | 49 | G-EDSWU-M63-L66L-STES-S | 1411103 | 235 |
| | | | FBP-2/B7 | 3069498 | 105 | FOC-V14-C1ZNI-B/SJFP:10 | 1408053 | 49 | G-ESS-M20-S66L-NTES-S | 1411075 | 234 |
| | | | FBP-2/C14 | 3069502 | 113 | FOC-V14-C1ZNI-S/SJFG | 1407898 | 48 | G-ESS-M20-S66L-STES-S | 1411076 | 234 |
| | | | FBP-2/C19 | 3069504 | 117 | FOC-V14-C1ZNI-S/SJFG:10 | 1408049 | 48 | G-ESS-M25-M66L-NTES-S | 1411077 | 234 |
| | | | FBP-2/D19 | 3069671 | 119 | FOC-V14-C1ZNI-S/SJFH | 1407897 | 48 | G-ESS-M25-M66L-STES-S | 1411078 | 234 |
| | | | FBP-2/E7 | 3069499 | 107 | FOC-V14-C1ZNI-S/SJFH:10 | 1408048 | 48 | G-ESS-M32-M66L-NTES-S | 1411079 | 234 |
| | | | FBP-2/F19 | 3069675 | 121 | FOC-V14-C1ZNI-S/SJFP | 1407896 | 48 | G-ESS-M32-M66L-STES-S | 1411080 | 234 |
| | | | FBP-2/G19 | 3069676 | 123 | FOC-V14-C1ZNI-S/SJFP:10 | 1408047 | 48 | G-ESS-M40-L66L-NTES-S | 1411081 | 234 |
| | | | FBP-2/H19 | 3069677 | 125 | FOC-V14-C1ZNI-T/SJFG | 1408030 | 48 | G-ESS-M40-L66L-STES-S | 1411082 | 234 |
| | | | FBP-2/I19 | 3069678 | 127 | FOC-V14-C1ZNI-T/SJFH | 1408029 | 48 | G-ESS-M50-L66L-NTES-S | 1411084 | 234 |
| | | | FBS 1/3-8 | 3032363 | 101 | FOC-V14-C1ZNI-T/SJFH:10 | 1408094 | 48 | G-ESS-M50-L66L-STES-S | 1411085 | 234 |
| | | | FBS 1/3/5-8 | 3032389 | 101 | FOC-V14-C1ZNI-T/SJFP | 1408028 | 48 | G-ESS-M63-L66L-NTES-S | 1411086 | 234 |
| | | | FBS 1/4-8 | 3032376 | 101 | FOC-V14-C1ZNI-T/SJFP:10 | 1408093 | 48 | G-ESS-M63-L66L-STES-S | 1411087 | 234 |
| | | | FBS 1/4/7/10-8 | 3032402 | 101 | FT NUT M25 BK | 1457937 | 77 | G-ESSWU-M20-M66L-NTES-S | 1411090 | 235 |
| | | | FBS 2-5 | 3030161 | 160 | FTP-2/1 | 3069469 | 103 | G-ESSWU-M20S-S66L-NTES-S | 1411088 | 235 |
| | | | FBS 2-6 | 3030336 | 166 | FTP-2/10 | 3001712 | 96 | G-ESSWU-M25-M66L-NTES-S | 1411092 | 235 |
| | | | FBS 2-8 | 3030284 | 100 | FTP-2/12 | 3001714 | 96 | G-ESSWU-M32-L66L-NTES-S | 1411094 | 235 |
| | | | FBS 3-5 | 3030174 | 160 | FTP-2/14 | 3001716 | 96 | G-ESSWU-M40-L66L-NTES-S | 1411097 | 235 |
| | | | FBS 3-6 | 3030242 | 166 | FTP-2/15 | 3001717 | 96 | G-ESSWU-M50-L66L-NTES-S | 1411100 | 235 |
| | | | FBS 3-8 | 3030297 | 100 | FTP-2/17 | 3001720 | 96 | G-ESSWU-M63-L66L-NTES-S | 1411102 | 235 |
| | | | FBS 4-5 | 3030187 | 160 | FTP-2/19 | 3001723 | 96 | G-INS-M12-S68N-NNES-S | 1411160 | 229 |
| | | | FBS 4-6 | 3030255 | 166 | FTP-2/20 | 3001724 | 96 | G-INS-M12-S68N-PNES-BK | 1411131 | 225 |
| | | | FBS 4-8 | 3030307 | 100 | FTP-2/21 | 3001725 | 96 | G-INS-M12-S68N-PNES-GY | 1411123 | 224 |
| | | | FBS 5-5 | 3030190 | 160 | FTP-2/22 | 3001726 | 96 | G-INS-M16-S68N-NNES-S | 1411162 | 229 |
| | | | FBS 5-6 | 3030349 | 166 | FTP-2/25 | 3001729 | 96 | G-INS-M16-S68N-PNES-BK | 1411132 | 225 |
| | | | FBS 5-8 | 3030310 | 100 | FTP-2/4 | 3001706 | 96 | G-INS-M16-S68N-PNES-GY | 1411124 | 224 |
| | | | FBS 6-8 | 3032470 | 100 | FTP-2/5 | 3001707 | 96 | G-INS-M20-S68N-NNES-S | 1411163 | 229 |
| | | | FBS 10-3,5 | 3213056 | 156 | FTP-2/9 | 3001711 | 96 | G-INS-M20-S68N-PNES-BK | 1411133 | 225 |
| | | | FBS 10-5 | 3030213 | 160 | FTP-2/A14 | 3069474 | 109 | G-INS-M20-S68N-PNES-GY | 1411125 | 224 |
| | | | FBS 10-6 | 3030271 | 166 | FTP-2/A7 | 3069470 | 103 | G-INS-M25-M68N-NNES-S | 1411165 | 229 |
| | | | FBS 10-8 | 3030323 | 100 | FTP-2/B14 | 3069475 | 111 | G-INS-M25-M68N-PNES-BK | 1411134 | 225 |
| | | | FBS 2-18 | 2801068 | 306 | FTP-2/B19 | 3069477 | 115 | G-INS-M25-M68N-PNES-GY | 1411126 | 224 |
| | | | FBS 2-3,5 | 3213014 | 156 | FTP-2/B7 | 3069471 | 105 | G-INS-M32-M68N-NNES-S | 1411166 | 229 |
| | | | FBS 20-3,5 | 3213069 | 156 | FTP-2/C14 | 3069476 | 113 | G-INS-M32-M68N-PNES-BK | 1411136 | 225 |
| | | | FBS 20-5 | 3030226 | 160 | FTP-2/C19 | 3069478 | 117 | G-INS-M32-M68N-PNES-GY | 1411127 | 224 |
| | | | FBS 20-6 | 3030365 | 166 | FTP-2/D19 | 3069479 | 119 | G-INS-M40-M68N-NNES-S | 1411167 | 229 |
| | | | FBS 3-3,5 | 3213027 | 156 | FTP-2/E7 | 3069472 | 107 | G-INS-M40-M68N-PNES-BK | 1411137 | 225 |
| | | | FBS 4-3,5 | 3213030 | 156 | FTP-2/F19 | 3069480 | 121 | G-INS-M40-M68N-PNES-GY | 1411128 | 224 |
| | | | FBS 5-3,5 | 3213043 | 156 | FTP-2/G19 | 3069481 | 123 | G-INS-M50-L68L-PNES-BK | 1411138 | 225 |
| | | | FBS-FV | 3032185 | 160 | FTP-2/H19 | 3069482 | 125 | G-INS-M50-L68L-PNES-GY | 1411129 | 224 |
| | | | FBSR 16-8 | 3033816 | 100 | FTP-2/I19 | 3069483 | 127 | G-INS-M50-L68N-NNES-S | 1411168 | 229 |
| | | | FBSRH 2-8 | 3033802 | 100 | FTPR-2/10 | 3001688 | 96 | G-INS-M63-L68L-PNES-BK | 1411139 | 225 |
| | | | FBSRH 3-8 | 3033803 | 100 | FTPR-2/12 | 3001690 | 96 | G-INS-M63-L68L-PNES-GY | 1411130 | 224 |
| | | | FBSRH 4-8 | 3033804 | 100 | FTPR-2/14 | 3001692 | 96 | G-INS-M63-L68N-NNES-S | 1411169 | 229 |
| | | | FL CAT5 PATCH 3,0 | 2832292 | 391 | FTPR-2/15 | 3001693 | 96 | G-INS-N11-M68L-PNES-BK | 1411159 | 228 |
| | | | FL COMSERVER BAS 232/422/485-T | 2904681 | 391 | FTPR-2/17 | 3001696 | 96 | G-INS-N11-M68L-PNES-GY | 1411155 | 227 |
| | | | FL COMSERVER UNI 232/422/485-T | 2904817 | 391 | FTPR-2/19 | 3001698 | 96 | G-INS-N12-S68L-PNES-BK | 1411157 | 228 |
| | | | FL MC 2000E SM40 LC | 2891156 | 389 | FTPR-2/20 | 3001699 | 96 | G-INS-N12-S68L-PNES-GY | 1411153 | 227 |
| | | | FL MC 2000T SC | 2891315 | 388 | FTPR-2/21 | 3001700 | 96 | G-INS-N3/4-M68L-PNES-BK | 1411158 | 228 |
| | | | FL MC 2000T SM20 SC | 2891317 | 389 | FTPR-2/22 | 3001701 | 96 | G-INS-N3/4-M68L-PNES-GY | 1411154 | 227 |
| | | | FL MC 2000T SM40 SC | 2891318 | 389 | FTPR-2/25 | 3001704 | 96 | G-INS-N3/8-S68L-PNES-BK | 1411156 | 228 |
| | | | FL MC 2000T ST | 2891316 | 388 | FTPR-2/4 | 3001681 | 96 | G-INS-N3/8-S68L-PNES-GY | 1411152 | 227 |
| | | | FL MEM PLUG | 2891259 | 379 | FTPR-2/6 | 3001683 | 96 | G-INS-NPT1-M68L-NNES-S | 1411185 | 231 |
| | | | FL MEM PLUG/MRM | 2891275 | 379 | FTPR-2/9 | 3001687 | 96 | G-INS-NPT1/2-S68L-NNES-S | 1411183 | 231 |
| | | | FL RED 2001E PRP 2LC | 2701864 | 382 | FTPR-2/A14 | 3069487 | 109 | G-INS-NPT3/4-M68L-NNES-S | 1411184 | 231 |
| | | | FL RED 2003E PRP | 2701863 | 382 | FTPR-2/A7 | 3069484 | 103 | G-INS-NPT3/8-S68L-NNES-S | 1411182 | 231 |
| | | | FL SFP FX | 2891081 | 386 | FTPR-2/B14 | 3069488 | 111 | G-INS-PG11-S68N-NNES-S | 1411172 | 230 |
| | | | FL SFP FX SM | 2891082 | 386 | FTPR-2/B19 | 3069490 | 115 | G-INS-PG11-S68N-PNES-GY | 1411142 | 226 |
| | | | FL SWITCH 1708 M12 POE | 2701883 | 376 | FTPR-2/B7 | 3069485 | 105 | G-INS-PG13,5-S68N-NNES-S | 1411173 | 230 |
| | | | FL SWITCH 3012E-2SFX | 2891067 | 383 | FTPR-2/C14 | 3069489 | 113 | G-INS-PG13,5-S68N-PNES-GY | 1411143 | 226 |
| | | | FL SWITCH 3016E | 2891066 | 383 | FTPR-2/C19 | 3069491 | 117 | G-INS-PG16-S68N-NNES-S | 1411174 | 230 |
| | | | FL SWITCH 4800E-P1 | 2891075 | 384 | FTPR-2/D19 | 3069492 | 119 | G-INS-PG16-S68N-PNES-GY | 1411144 | 226 |
| | | | FL SWITCH 4800E-P5 | 2891076 | 384 | FTPR-2/E7 | 3069486 | 107 | G-INS-PG21-M68N-NNES-S | 1411175 | 230 |
| | | | FL SWITCH 4808E-16FX LC-4GC | 2891073 | 385 | FTPR-2/F19 | 3069493 | 121 | G-INS-PG21-M68N-PNES-GY | 1411145 | 226 |
| | | | FL SWITCH 4808E-16FX SM LC-4GC | 2891074 | 385 | FTPR-2/G19 | 3069494 | 123 | G-INS-PG29-M68N-NNES-S | 1411176 | 230 |
| | | | FL SWITCH 4808E-16FX SM-4GC | 2891080 | 385 | FTPR-2/H19 | 3069495 | 125 | G-INS-PG29-M68N-PNES-GY | 1411146 | 226 |
| | | | FL SWITCH 4808E-16FX-4GC | 2891079 | 385 | FTPR-2/I19 | 3069496 | 127 | G-INS-PG36-L68N-NNES-S | 1411178 | 230 |
| | | | FL SWITCH 4824E-4GC | 2891072 | 384 | | | | G-INS-PG36-L68N-PNES-GY | 1411147 | 226 |
| | | | FL SWITCH 7005/FX-2FXSM-EIP | 2701420 | 381 | | | | G-INS-PG42-L68N-NNES-S | 1411179 | 230 |
| | | | FL SWITCH 7006/2FX-EIP | 2701419 | 381 | | | | G-INS-PG42-L68N-PNES-GY | 1411149 | 226 |
| | | | FL SWITCH 7008-EIP | 2701418 | 380 | | | | G-INS-PG48-L68N-NNES-S | 1411181 | 230 |
| | | | FL SWITCH LM 8TX-B | 2989446 | 378 | | | | G-INS-PG48-L68N-PNES-GY | 1411150 | 226 |
| | | | FL SWITCH SMN 8TX-PN | 2989501 | 379 | | | | G-INS-PG7-S68N-NNES-S | 1411170 | 230 |
| | | | FL WLAN 5102 | 2701850 | 387 | | | | G-INS-PG7-S68N-PNES-GY | 1411140 | 226 |
| | | | FL-PP-RJ45-SCC/SC041 | 2903532 | 392 | G-EDSWU-M20-M66L-STES-S | 1411091 | 235 | G-INS-PG9-S68N-NNES-S | 1411171 | 230 |
| | | | FL-PP-RJ45-SCC/SC045 | 2904577 | 392 | G-EDSWU-M20S-S66L-STES-S | 1411089 | 235 | G-INS-PG9-S68N-PNES-GY | 1411141 | 226 |
| | | | FL-PP-RJ45/RJ45-B | 2904933 | 392 | G-EDSWU-M25-M66L-STES-S | 1411093 | 235 | G-INSEC-M12-S68N-NCRS-S | 1411187 | 232 |
| | | | FOC-V14-C1ZNI-B/SJFG | 1407905 | 49 | G-EDSWU-M32-L66L-STES-S | 1411095 | 235 | G-INSEC-M16-S68N-NCRS-S | 1411188 | 232 |

Index

Alphabetical

| Type | Order No. | Page | Type | Order No. | Page | Type | Order No. | Page | Type | Order No. | Page |
|----------------------------|-----------|------|---------------------------------|-----------|------|------------------------------|-----------|------|----------------------------|-----------|------|
| G-INSEC-M20-S68N-NCRS-S | 1411189 | 232 | HC-EVO-B16-CHWS-ELC-AL | 1411464 | 208 | HMI SCB MOUNTING KIT 8 | 2701387 | 419 | KV-DI-PG16-1XASI | 1582462 | 195 |
| G-INSEC-M25-S68N-NCRS-S | 1411190 | 232 | HC-EVO-B16-HHFD-EL-AL | 1411460 | 209 | HSCH 2,5-2U-2220 9005 | 2201792 | 35 | KV-DI-PG16-2XASI | 1582464 | 195 |
| G-INSEC-M32-M68N-NCRS-S | 1411191 | 232 | HC-EVO-B16-HHFS-EL-AL | 1411461 | 208 | HC-EVO-B16-HHFD-EL-AL | 2201791 | 35 | | | |
| G-INSEC-M40-M68N-NCRS-S | 1411192 | 232 | HC-EVO-B16-HHWD-EL-AL | 1411462 | 210 | HSCH 2,5-2U-TTTT 9005 | 2201790 | 35 | | | |
| G-INSEC-M50-L68N-NCRS-S | 1411193 | 232 | HC-EVO-B16PT-BWD-HH-M25ELC-AL | 1411489 | 209 | HSCH 2,5-2U/ 8 9005 | 2201789 | 35 | | | |
| G-INSEC-M63-L68N-NCRS-S | 1411194 | 232 | HC-EVO-B16PT-BWSC-HH-M25ELC-AL | 1411492 | 208 | HSCH 2,5-3U/12 9005 | 2201788 | 35 | | | |
| G-INSEC-PG11-S68N-NCRS-S | 1411197 | 233 | HC-EVO-B24-CHWD-ELC-AL | 1411475 | 212 | HSCP-SP 2,5-1U-20 7035 | 2201782 | 35 | | | |
| G-INSEC-PG13,5-S68N-NCRS-S | 1411198 | 233 | HC-EVO-B24-CHWS-ELC-AL | 1411476 | 211 | HSCP-SP 2,5-1U-TT 7035 | 2201781 | 35 | | | |
| G-INSEC-PG16-S68N-NCRS-S | 1411199 | 233 | HC-EVO-B24-HHFD-EL-AL | 1411472 | 212 | | | | | | |
| G-INSEC-PG21-L68N-NCRS-S | 1411200 | 233 | HC-EVO-B24-HHFS-EL-AL | 1411473 | 211 | HSCP-SP 2,5-1U/ 4 7035 | 2201780 | 35 | LS-EML (180X180) BK-WH | 0831784 | 262 |
| G-INSEC-PG29-M68N-NCRS-S | 1411201 | 233 | HC-EVO-B24-HHWD-EL-AL | 1411474 | 213 | | | | LS-EML (180X180) BK-WH CUS | 0832070 | 262 |
| G-INSEC-PG36-L68N-NCRS-S | 1411202 | 233 | HC-EVO-B24PT-BWD-HH-M32ELC-AL | 1411490 | 212 | | | | LS-EMLP (100X60) SR | 0831726 | 257 |
| | | | | | | | | | LS-EMLP (100X60) SR CUS | 0832012 | 259 |
| G-INSEC-PG42-L68N-NCRS-S | 1411203 | 233 | HC-EVO-B24PT-BWSC-HH-M32ELC-AL | 1411493 | 211 | | | | LS-EMLP (100X60) WH | 0831699 | 256 |
| G-INSEC-PG48-L68N-NCRS-S | 1411204 | 233 | HC-EVO-D15-BWS-PLR-BK | 1411336 | 196 | | | | LS-EMLP (100X60) WH CUS | 0831985 | 258 |
| G-INSEC-PG7-S68N-NCRS-S | 1411195 | 233 | HC-EVO-D15-BWSC-PLR-BK | 1411337 | 196 | | | | LS-EMLP (100X60) YE | 0831753 | 257 |
| G-INSEC-PG9-S68N-NCRS-S | 1411196 | 233 | HC-EVO-D15-CHWS-PL-BK | 1411338 | 196 | | | | LS-EMLP (100X60) YE CUS | 0832039 | 259 |
| | | | | | | | | | | | |
| GPE 13X 9 WH | 0806932 | 195 | HC-EVO-D15-HHFS-PL-BK | 1411340 | 196 | IB IL MBUS-PAC | 2701927 | 416 | LS-EMLP (11X9) SR | 0831705 | 257 |
| | | | HC-EVO-D15-SLWS-2SSM25-PLR-BK | 1411341 | 196 | IFS-CONFSTICK | 2986122 | 358 | LS-EMLP (11X9) SR CUS | 0831991 | 259 |
| | | | HC-EVO-D15-SLWSC-2SSM25-PLR-BK | 1411343 | 196 | IFS-USB-DATACABLE | 2320500 | 358 | LS-EMLP (11X9) WH | 0831678 | 256 |
| | | | HC-EVO-D25-BWS-PLR-BK | 1411344 | 197 | IFS-USB-PROG-ADAPTER | 2811271 | 339 | LS-EMLP (11X9) WH CUS | 0831964 | 258 |
| | | | | | | | | | | | |
| | | | HC-EVO-D25-BWSC-PLR-BK | 1411345 | 197 | | | | LS-EMLP (11X9) YE | 0831732 | 257 |
| | | | HC-EVO-D25-CHWS-PLR-BK | 1411346 | 197 | IMC 1,5/ 2-G-3,5 P20 THR | 1830414 | 16 | LS-EMLP (11X9) YE CUS | 0832018 | 259 |
| | | | HC-EVO-D25-HHFS-PL-BK | 1411347 | 197 | IMC 1,5/ 3-G-3,5 P20 THR | 1830427 | 16 | LS-EMLP (13X9) SR | 0831706 | 257 |
| | | | HC-EVO-D25-SLWS-2SSM25-PLR-BK | 1411348 | 197 | IMC 1,5/ 3-G-3,5 RN P20 THR | 1830579 | 17 | LS-EMLP (13X9) SR CUS | 0831992 | 259 |
| | | | | | | | | | | | |
| | | | HC-EVO-D25-SLWSC-2SSM25-PLR-BK | 1411349 | 197 | IMC 1,5/ 4-G-3,5 P20 THR | 1830430 | 16 | LS-EMLP (13X9) WH | 0831679 | 256 |
| | | | HC-EVO-D15-BWS-PLR-BK | 1411122 | 214 | IMC 1,5/ 4-G-3,5 RN P20 THR | 1830582 | 17 | LS-EMLP (13X9) WH CUS | 0831965 | 258 |
| | | | HC-HPR-B06-HHWH-1STM20-EM-BK | 1411878 | 214 | IMC 1,5/ 5-G-3,5 P20 THR | 1830443 | 16 | LS-EMLP (13X9) YE | 0831733 | 257 |
| | | | HC-HPR-B06-HHWH-1STM25-EM-BK | 1411119 | 214 | IMC 1,5/ 5-G-3,5 RN P20 THR | 1830595 | 17 | LS-EMLP (13X9) YE CUS | 0832019 | 259 |
| | | | | | | | | | | | |
| | | | HC-HPR-B06-HHWH-1TTM20-EM-BK | 1411879 | 214 | IMC 1,5/ 6-G-3,5 P20 THR | 1830456 | 16 | LS-EMLP (17,5X12) SR | 0831709 | 257 |
| | | | HC-HPR-B06-HHWH-1TTM25-EM-BK | 1411106 | 214 | IMC 1,5/ 6-G-3,5 RN P20 THR | 1830605 | 17 | LS-EMLP (17,5X12) SR CUS | 0831995 | 259 |
| | | | HC-HPR-B06-SHFH-2SSM20-EMR-BK | 1411880 | 214 | IMC 1,5/ 7-G-3,5 P20 THR | 1830469 | 16 | LS-EMLP (17,5X12) WH | 0831682 | 256 |
| | | | HC-HPR-B06-SHFH-2SSM25-EMR-BK | 1411103 | 214 | IMC 1,5/ 7-G-3,5 RN P20 THR | 1830618 | 17 | LS-EMLP (17,5X12) WH CUS | 0831968 | 258 |
| | | | | | | | | | | | |
| | | | HC-HPR-B10-BFH-EMR-BK | 1411083 | 215 | IMC 1,5/ 8-G-3,5 P20 THR | 1830472 | 16 | LS-EMLP (17,5X12) YE | 0831736 | 257 |
| | | | HC-HPR-B10-HHWH-1STM25EM-BK | 1411881 | 215 | IMC 1,5/ 8-G-3,5 RN P20 THR | 1830621 | 17 | LS-EMLP (17,5X12) YE CUS | 0832022 | 259 |
| | | | HC-HPR-B10-HHWH-1STM32-EM-BK | 1411070 | 215 | IMC 1,5/ 9-G-3,5 P20 THR | 1830485 | 16 | LS-EMLP (17,5X15) SR | 0831710 | 257 |
| | | | HC-HPR-B10-HHWH-1TTM25-EM-BK | 1411882 | 215 | IMC 1,5/ 9-G-3,5 RN P20 THR | 1830634 | 17 | LS-EMLP (17,5X15) SR CUS | 0831996 | 259 |
| | | | | | | | | | | | |
| | | | HC-HPR-B10-HHWH-1TTM32-EM-BK | 1411067 | 215 | IMC 1,5/10-G-3,5 P20 THR | 1830498 | 16 | LS-EMLP (17,5X15) WH | 0831683 | 256 |
| | | | HC-HPR-B10-SHFH-2SSM25-EMR-BK | 1411883 | 215 | IMC 1,5/10-G-3,5 RN P20 THR | 1830647 | 17 | LS-EMLP (17,5X15) WH CUS | 0831969 | 258 |
| | | | HC-HPR-B10-SHFH-2SSM32-EMR-BK | 1411096 | 215 | IMC 1,5/11-G-3,5 P20 THR | 1830508 | 16 | LS-EMLP (17,5X15) YE | 0831737 | 257 |
| | | | HC-HPR-B16-BFH-EMR-BK | 1411060 | 216 | IMC 1,5/11-G-3,5 RN P20 THR | 1830650 | 17 | LS-EMLP (17,5X15) YE CUS | 0832023 | 259 |
| | | | | | | | | | | | |
| | | | HC-HPR-B16-HHWH-1STM32-EM-BK | 1411058 | 216 | IMC 1,5/12-G-3,5 P20 THR | 1830511 | 16 | LS-EMLP (17X7) SR | 0831707 | 257 |
| | | | HC-HPR-B16-HHWH-1STM40-EM-BK | 1411884 | 216 | IMC 1,5/12-G-3,5 RN P20 THR | 1830663 | 17 | LS-EMLP (17X7) SR CUS | 0831993 | 259 |
| | | | HC-HPR-B16-HHWH-1TTM32-EM-BK | 1411059 | 216 | IMCV 1,5/ 2-G-3,5 P20 THR | 1830715 | 17 | LS-EMLP (17X7) WH | 0831680 | 256 |
| | | | HC-HPR-B16-HHWH-1TTM40-EM-BK | 1411885 | 216 | IMCV 1,5/ 2-G-3,5 RN P20 THR | 1830867 | 17 | LS-EMLP (17X7) WH CUS | 0831966 | 258 |
| | | | | | | | | | | | |
| | | | HC-HPR-B16-SHFH-2SSM32-EMR-BK | 1411054 | 216 | IMCV 1,5/ 3-G-3,5 P20 THR | 1830728 | 17 | LS-EMLP (17X7) YE | 0831734 | 257 |
| | | | HC-HPR-B16-SHFH-2SSM40-EMR-BK | 1411886 | 216 | IMCV 1,5/ 3-G-3,5 RN P20 THR | 1830870 | 17 | LS-EMLP (17X7) YE CUS | 0832020 | 259 |
| | | | HC-HPR-B24-BFH-EMR-BK | 1411055 | 217 | IMCV 1,5/ 4-G-3,5 P20 THR | 1830731 | 17 | LS-EMLP (17X9) SR | 0831708 | 257 |
| | | | HC-HPR-B24-HHWH-1STM32-EM-BK | 1411887 | 217 | IMCV 1,5/ 4-G-3,5 RN P20 THR | 1830883 | 17 | LS-EMLP (17X9) SR CUS | 0831994 | 259 |
| | | | | | | | | | | | |
| | | | HC-HPR-B24-HHWH-1STM40-EM-BK | 1411061 | 217 | IMCV 1,5/ 5-G-3,5 P20 THR | 1830744 | 17 | LS-EMLP (17X9) WH | 0831681 | 256 |
| | | | HC-HPR-B24-HHWH-1TTM32-EM-BK | 1411888 | 217 | IMCV 1,5/ 5-G-3,5 RN P20 THR | 1830896 | 17 | LS-EMLP (17X9) WH CUS | 0831967 | 258 |
| | | | HC-HPR-B24-HHWH-1TTM40-EM-BK | 1411062 | 217 | IMCV 1,5/ 6-G-3,5 P20 THR | 1830757 | 17 | LS-EMLP (17X9) YE | 0831735 | 257 |
| | | | HC-HPR-B24-SHFH-2SSM32-EMR-BK | 1411889 | 217 | IMCV 1,5/ 6-G-3,5 RN P20 THR | 1830906 | 17 | LS-EMLP (17X9) YE CUS | 0832021 | 259 |
| | | | | | | | | | | | |
| | | | HC-HPR-B24-SHFH-2SSM40-EMR-BK | 1411063 | 217 | IMCV 1,5/ 7-G-3,5 P20 THR | 1830760 | 17 | LS-EMLP (20X7) SR | 0831711 | 257 |
| | | | HC-HS06-I-UT-F | 1406530 | 201 | IMCV 1,5/ 7-G-3,5 RN P20 THR | 1830919 | 17 | LS-EMLP (20X7) SR CUS | 0831997 | 259 |
| | | | HC-HS06-I-UT-F 7-12 | 1406533 | 201 | IMCV 1,5/ 8-G-3,5 P20 THR | 1830773 | 17 | LS-EMLP (20X7) WH | 0831684 | 256 |
| | | | HC-HS06-I-UT-M | 1406531 | 201 | IMCV 1,5/ 8-G-3,5 RN P20 THR | 1830922 | 17 | LS-EMLP (20X7) WH CUS | 0831970 | 258 |
| | | | | | | | | | | | |
| | | | HC-HS06-I-UT-M 7-12 | 1406534 | 201 | IMCV 1,5/ 9-G-3,5 P20 THR | 1830786 | 17 | LS-EMLP (20X7) YE | 0831738 | 257 |
| | | | HC-K-BS-M25 BK | 1411245 | 219 | IMCV 1,5/ 9-G-3,5 RN P20 THR | 1830935 | 17 | LS-EMLP (20X7) YE CUS | 0832024 | 259 |
| | | | HC-K-BS-M32-BK | 1410754 | 219 | IMCV 1,5/10-G-3,5 P20 THR | 1830799 | 17 | LS-EMLP (20X8) SR | 0831712 | 257 |
| | | | HC-K-BS-M40-BK | 1410767 | 219 | IMCV 1,5/10-G-3,5 RN P20 THR | 1830948 | 17 | LS-EMLP (20X8) SR CUS | 0831998 | 259 |
| | | | | | | | | | | | |
| | | | HC-K-KV-M20(5-13)BK | 1411261 | 218 | IMCV 1,5/11-G-3,5 P20 THR | 1830809 | 17 | LS-EMLP (20X8) WH | 0831685 | 256 |
| | | | HC-K-KV-M25(8-17)BK | 1411258 | 218 | IMCV 1,5/11-G-3,5 RN P20 THR | 1830951 | 17 | LS-EMLP (20X8) WH CUS | 0831971 | 258 |
| | | | HC-K-KV-M32(12-21)BK | 1407673 | 218 | IMCV 1,5/12-G-3,5 P20 THR | 1830812 | 17 | LS-EMLP (20X8) YE | 0831739 | 257 |
| | | | HC-K-KV-M40(16-28)BK | 1407674 | 218 | IMCV 1,5/12-G-3,5 RN P20 THR | 1830964 | 17 | LS-EMLP (20X8) YE CUS | 0832025 | 259 |
| | | | | | | | | | | | |
| | | | HC-EVO-A16UT-BWSC-HH-M25-PLR-BK | 1411359 | 197 | ISH 2,5/0,2 | 3002843 | 160 | LS-EMLP (22X12) SR | 0831713 | 257 |
| | | | HC-EVO-A10UT-BWSC-HH-M20-PLR-BK | 1411356 | 196 | ISH 2,5/0,5 | 3002856 | 160 | LS-EMLP (22X12) SR CUS | 0831999 | 259 |
| | | | HC-EVO-A10UT-BWSC-HH-M20-PLR-BK | 1411357 | 196 | ISH 2,5/1,0 | 3002869 | 160 | LS-EMLP (22X12) WH | 0831686 | 256 |
| | | | HC-EVO-A16UT-BWSC-HH-M25-PLR-BK | 1411358 | 197 | | | | LS-EMLP (22X12) WH CUS | 0831972 | 258 |
| | | | | | | | | | | | |
| | | | HC-EVO-B06-CHWS-ELC-AL | 1411459 | 204 | | | | | | |
| | | | HC-EVO-B06-HHFS-EL-AL | 1411447 | 204 | | | | | | |
| | | | HC-EVO-B06-HLFS-EL-AL | 1411448 | 204 | | | | | | |
| | | | | | | | | | | | |
| | | | HC-EVO-B06PT-BWSC-HL-M20ELC-AL | 1411487 | 204 | HC-STA-B06-BWS-ELC-AL | 1411318 | 204 | LS-EMLP (22X12) YE | 0831740 | 257 |
| | | | HC-EVO-B10-CHWD-ELC-AL | 1411458 | 206 | HC-STA-B06-BWSC-ELC-AL | 1411319 | 204 | LS-EMLP (22X12) YE CUS | 0832026 | 259 |
| | | | HC-EVO-B10-CHWS-ELC-AL | 1411459 | 205 | HC-STA-B10-BFDC-ELC-AL | 1411323 | 207 | LS-EMLP (22X22) SR | 0831714 | 257 |
| | | | HC-EVO-B10-HHFD-EL-AL | 1411451 | 206 | HC-STA-B10-BWD-ELC-AL | | | | | |

| Type | Order No. | Page | Type | Order No. | Page | Type | Order No. | Page | Type | Order No. | Page |
|---------------------------|-----------|------|-----------------------------|-----------|------|-----------------------------|-----------|------|-------------------------------|-----------|------|
| LS-EMLP (27X12,5) YE | 0831743 | 257 | LS-EMLP-AL (100X60) | 0831586 | 252 | LS-EMSP-AL (150X80) | 0831621 | 251 | LS-WMTB-V4A (29X8) | 0831516 | 247 |
| LS-EMLP (27X12,5) YE CUS | 0832029 | 259 | LS-EMLP-AL (100X60) BK | 0831595 | 253 | LS-EMSP-AL (150X80) BK | 0831632 | 251 | LS-WMTB-V4A (29X8) CUS | 0831802 | 247 |
| LS-EMLP (27X15) SR | 0831717 | 257 | LS-EMLP-AL (100X60) BK CUS | 0831881 | 253 | LS-EMSP-AL (150X80) BK CUS | 0831918 | 251 | LS-WMTB-V4A (40X15) | 0831517 | 247 |
| LS-EMLP (27X15) SR CUS | 0832003 | 259 | LS-EMLP-AL (100X60) CUS | 0831872 | 252 | LS-EMSP-AL (150X80) CUS | 0831907 | 251 | LS-WMTB-V4A (40X15) CUS | 0831803 | 247 |
| LS-EMLP (27X15) WH | 0831690 | 256 | LS-EMLP-AL (27X15) | 0831580 | 252 | LS-EMSP-AL (170X180) | 0831623 | 251 | LS-WMTB-V4A (60X15) | 0831518 | 247 |
| LS-EMLP (27X15) WH CUS | 0831976 | 258 | LS-EMLP-AL (27X15) BK | 0831589 | 253 | LS-EMSP-AL (170X180) BK | 0831634 | 251 | LS-WMTB-V4A (60X15) CUS | 0831804 | 247 |
| LS-EMLP (27X15) YE | 0831744 | 257 | LS-EMLP-AL (27X15) BK CUS | 0831875 | 253 | LS-EMSP-AL (170X180) BK CUS | 0831920 | 251 | LS-WMTB-V4A (D25) | 0831520 | 249 |
| LS-EMLP (27X15) YE CUS | 0832030 | 259 | LS-EMLP-AL (27X15) CUS | 0831866 | 252 | LS-EMSP-AL (170X180) CUS | 0831909 | 251 | LS-WMTB-V4A (D25) CUS | 0831806 | 249 |
| LS-EMLP (27X18) SR | 0831718 | 257 | LS-EMLP-AL (27X18) | 0831581 | 252 | LS-EMSP-AL (39X15) | 0831615 | 251 | LS-WMTB-V4A (D30) | 0831521 | 249 |
| LS-EMLP (27X18) SR CUS | 0832004 | 259 | LS-EMLP-AL (27X18) BK | 0831590 | 253 | LS-EMSP-AL (39X15) BK | 0831626 | 251 | LS-WMTB-V4A (D30) CUS | 0831807 | 249 |
| LS-EMLP (27X18) WH | 0831691 | 256 | LS-EMLP-AL (27X18) BK CUS | 0831876 | 253 | LS-EMSP-AL (39X15) BK CUS | 0831912 | 251 | | | |
| LS-EMLP (27X18) WH CUS | 0831977 | 258 | LS-EMLP-AL (27X18) CUS | 0831867 | 252 | LS-EMSP-AL (39X15) CUS | 0831901 | 251 | | | |
| LS-EMLP (27X18) YE | 0831745 | 257 | LS-EMLP-AL (49X15) | 0831582 | 252 | LS-EMSP-AL (50X15) | 0831616 | 251 | | | |
| LS-EMLP (27X18) YE CUS | 0832031 | 259 | LS-EMLP-AL (49X15) BK | 0831591 | 253 | LS-EMSP-AL (50X15) BK | 0831627 | 251 | | | |
| LS-EMLP (27X27) SR | 0831719 | 257 | LS-EMLP-AL (49X15) BK CUS | 0831877 | 253 | LS-EMSP-AL (50X15) BK CUS | 0831913 | 251 | | | |
| LS-EMLP (27X27) SR CUS | 0832005 | 259 | LS-EMLP-AL (49X15) CUS | 0831868 | 252 | LS-EMSP-AL (50X15) CUS | 0831902 | 251 | | | |
| LS-EMLP (27X27) WH | 0831692 | 256 | LS-EMLP-AL (60X15) | 0831583 | 252 | LS-EMSP-AL (50X30) | 0831617 | 251 | MACX MCR-EX-I20 | 2905679 | 346 |
| LS-EMLP (27X27) WH CUS | 0832008 | 258 | LS-EMLP-AL (60X15) BK | 0831592 | 253 | LS-EMSP-AL (50X30) BK | 0831628 | 251 | MACX MCR-I20 | 2905680 | 343 |
| LS-EMLP (27X27) YE | 0831746 | 257 | LS-EMLP-AL (60X15) BK CUS | 0831878 | 253 | LS-EMSP-AL (50X30) BK CUS | 0831914 | 251 | MACX PL-EX-RPSS-2I-2I | 2904963 | 345 |
| LS-EMLP (27X27) YE CUS | 0832032 | 259 | LS-EMLP-AL (60X15) CUS | 0831869 | 252 | LS-EMSP-AL (50X30) BU | 0831645 | 251 | MACX PL-EX-RPSS-2I-2I-SP | 2904964 | 345 |
| LS-EMLP (27X8) SR | 0831715 | 257 | LS-EMLP-AL (60X30) | 0831584 | 252 | LS-EMSP-AL (50X30) BU CUS | 0831931 | 251 | MACX PL-EX-RPSSI-2I | 2904959 | 344 |
| LS-EMLP (27X8) SR CUS | 0832001 | 259 | LS-EMLP-AL (60X30) BK | 0831593 | 253 | LS-EMSP-AL (50X30) BK | 0831903 | 251 | MACX PL-EX-RPSSI-2I-SP | 2904960 | 344 |
| LS-EMLP (27X8) WH | 0831688 | 256 | LS-EMLP-AL (60X30) BK CUS | 0831879 | 253 | LS-EMSP-AL (50X30) GN | 0831649 | 251 | MACX PL-EX-T-UIREL-UP | 2904910 | 346 |
| LS-EMLP (27X8) WH CUS | 0831974 | 258 | LS-EMLP-AL (60X30) BU | 0831606 | 253 | LS-EMSP-AL (50X30) GN CUS | 0831935 | 251 | MACX PL-EX-T-UIREL-UP-SP | 2904912 | 346 |
| LS-EMLP (27X8) YE | 0831742 | 257 | LS-EMLP-AL (60X30) BU CUS | 0831892 | 253 | LS-EMSP-AL (50X30) OG | 0831641 | 251 | MACX PL-RPSSI-2I | 2904961 | 342 |
| LS-EMLP (27X8) YE CUS | 0832004 | 259 | LS-EMLP-AL (60X30) CUS | 0831870 | 252 | LS-EMSP-AL (50X30) OG CUS | 0831927 | 251 | MACX PL-RPSSI-2I-SP | 2904962 | 342 |
| LS-EMLP (45X14) SR | 0831720 | 257 | LS-EMLP-AL (60X30) GN | 0831610 | 253 | LS-EMSP-AL (50X30) RD | 0831637 | 251 | MACX PL-T-UIREL-UP | 2904901 | 343 |
| LS-EMLP (45X14) SR CUS | 0832006 | 259 | LS-EMLP-AL (60X30) GN CUS | 0831896 | 253 | LS-EMSP-AL (50X30) RD CUS | 0831923 | 251 | MACX PL-T-UIREL-UP-SP | 2904903 | 343 |
| LS-EMLP (45X14) WH | 0831693 | 256 | LS-EMLP-AL (60X30) OG | 0831602 | 253 | LS-EMSP-AL (75,6X54) | 0831618 | 251 | MC 1,5/13-G-3,81 P20 THR | 1829056 | 18 |
| LS-EMLP (45X14) WH CUS | 0831979 | 258 | LS-EMLP-AL (60X30) OG CUS | 0831888 | 253 | LS-EMSP-AL (75,6X54) BK | 0831629 | 251 | MC 1,5/13-G-3,81 P20 THRR72 | 1828691 | 20 |
| LS-EMLP (45X14) YE | 0831747 | 257 | LS-EMLP-AL (60X30) RD | 0831598 | 253 | LS-EMSP-AL (75,6X54) BK CUS | 0831915 | 251 | MC 1,5/13-GF-3,81 P20 THR | 1829137 | 19 |
| LS-EMLP (45X14) YE CUS | 0832033 | 259 | LS-EMLP-AL (60X30) RD CUS | 0831884 | 253 | LS-EMSP-AL (75,6X54) BU | 0831646 | 251 | MC 1,5/13-GF-3,81 P20 THRR72 | 1828772 | 21 |
| LS-EMLP (45X15) SR | 0831721 | 257 | LS-EMLP-AL (85,6X54) | 0831585 | 252 | LS-EMSP-AL (75,6X54) BU CUS | 0831932 | 251 | MC 1,5/14-G-3,81 P20 THR | 1829072 | 18 |
| LS-EMLP (45X15) SR CUS | 0832007 | 259 | LS-EMLP-AL (85,6X54) BK | 0831594 | 253 | LS-EMSP-AL (75,6X54) CUS | 0831904 | 251 | MC 1,5/14-G-3,81 P20 THRR88 | 1828701 | 20 |
| LS-EMLP (45X15) WH | 0831694 | 256 | LS-EMLP-AL (85,6X54) BK CUS | 0831880 | 253 | LS-EMSP-AL (75,6X54) GN | 0831650 | 251 | MC 1,5/14-GF-3,81 P20 THR | 1829140 | 19 |
| LS-EMLP (45X15) WH CUS | 0831980 | 258 | LS-EMLP-AL (85,6X54) BU | 0831607 | 253 | LS-EMSP-AL (75,6X54) GN CUS | 0831936 | 251 | MC 1,5/14-GF-3,81 P20 THRR88 | 1828785 | 21 |
| LS-EMLP (45X15) YE | 0831748 | 257 | LS-EMLP-AL (85,6X54) BU CUS | 0831893 | 253 | LS-EMSP-AL (75,6X54) OG | 0831642 | 251 | MC 1,5/15-G-3,81 P20 THR | 1829072 | 18 |
| LS-EMLP (45X15) YE CUS | 0832034 | 259 | LS-EMLP-AL (85,6X54) CUS | 0831871 | 252 | LS-EMSP-AL (75,6X54) OG CUS | 0831928 | 251 | MC 1,5/15-G-3,81 P20 THRR88 | 1828714 | 20 |
| LS-EMLP (49X15) SR | 0831722 | 257 | LS-EMLP-AL (85,6X54) GN | 0831611 | 253 | LS-EMSP-AL (75,6X54) RD | 0831638 | 251 | MC 1,5/15-GF-3,81 P20 THR | 1829153 | 19 |
| LS-EMLP (49X15) SR CUS | 0832008 | 259 | LS-EMLP-AL (85,6X54) GN CUS | 0831897 | 253 | LS-EMSP-AL (75,6X54) RD CUS | 0831924 | 251 | MC 1,5/15-GF-3,81 P20 THRR88 | 1828798 | 21 |
| LS-EMLP (49X15) WH | 0831695 | 256 | LS-EMLP-AL (85,6X54) OG | 0831603 | 253 | LS-EMSP-AL (90X60) | 0831619 | 251 | MC 1,5/16-G-3,81 P20 THR | 1829085 | 18 |
| LS-EMLP (49X15) WH CUS | 0831981 | 258 | LS-EMLP-AL (85,6X54) OG CUS | 0831889 | 253 | LS-EMSP-AL (90X60) BK | 0831630 | 251 | MC 1,5/16-G-3,81 P20 THRR88 | 1828727 | 20 |
| LS-EMLP (49X15) YE | 0831749 | 257 | LS-EMLP-AL (85,6X54) RD | 0831599 | 253 | LS-EMSP-AL (90X60) BK CUS | 0831916 | 251 | MC 1,5/16-GF-3,81 P20 THR | 1829166 | 19 |
| LS-EMLP (49X15) YE CUS | 0832035 | 259 | LS-EMLP-AL (85,6X54) RD CUS | 0831885 | 253 | LS-EMSP-AL (90X60) CUS | 0831905 | 251 | MC 1,5/16-GF-3,81 P20 THRR88 | 1828808 | 21 |
| LS-EMLP (60X15) SR | 0831723 | 257 | LS-EMP-AL (100X60) | 0831667 | 254 | LS-EMSP-V4A (39X15) | 0831653 | 250 | MC 1,5/17-G-3,81 P20 THR | 1829098 | 18 |
| LS-EMLP (60X15) SR CUS | 0832009 | 259 | LS-EMP-AL (100X60) BK | 0831675 | 255 | LS-EMSP-V4A (39X15) CUS | 0831939 | 250 | MC 1,5/17-G-3,81 P20 THRR88 | 1828730 | 20 |
| LS-EMLP (60X15) WH | 0831696 | 256 | LS-EMP-AL (100X60) BK CUS | 0831961 | 255 | LS-EMSP-V4A (50X15) | 0831654 | 250 | MC 1,5/17-GF-3,81 P20 THR | 1829179 | 19 |
| LS-EMLP (60X15) WH CUS | 0831982 | 258 | LS-EMP-AL (100X60) CUS | 0831953 | 254 | LS-EMSP-V4A (50X15) CUS | 0831940 | 250 | MC 1,5/17-GF-3,81 P20 THRR88 | 1828811 | 21 |
| LS-EMLP (60X15) YE | 0831750 | 257 | LS-EMP-AL (27X15) | 0831661 | 254 | LS-EMSP-V4A (50X30) | 0831655 | 250 | MC 1,5/18-G-3,81 P20 THR | 1829108 | 18 |
| LS-EMLP (60X15) YE CUS | 0832036 | 259 | LS-EMP-AL (27X15) BK | 0831669 | 255 | LS-EMSP-V4A (50X30) CUS | 0831941 | 250 | MC 1,5/18-G-3,81 P20 THRR88 | 1828743 | 20 |
| LS-EMLP (60X30) SR | 0831724 | 257 | LS-EMP-AL (27X15) BK CUS | 0831955 | 255 | LS-EMSP-V4A (75,6X54) | 0831656 | 250 | MC 1,5/18-GF-3,81 P20 THR | 1829182 | 19 |
| LS-EMLP (60X30) SR CUS | 0832010 | 259 | LS-EMP-AL (27X15) CUS | 0831947 | 254 | LS-EMSP-V4A (75,6X54) CUS | 0831942 | 250 | MC 1,5/18-GF-3,81 P20 THRR88 | 1828824 | 21 |
| LS-EMLP (60X30) WH | 0831697 | 256 | LS-EMP-AL (27X18) | 0831662 | 254 | LS-EMSP-V4A (90X60) | 0831657 | 250 | MC 1,5/19-G-3,81 P20 THR | 1829111 | 18 |
| LS-EMLP (60X30) WH CUS | 0831983 | 258 | LS-EMP-AL (27X18) BK | 0831670 | 255 | LS-EMSP-V4A (90X60) CUS | 0831943 | 250 | MC 1,5/19-G-3,81 P20 THRR104 | 1828756 | 20 |
| LS-EMLP (60X30) YE | 0831751 | 257 | LS-EMP-AL (27X18) BK CUS | 0831956 | 255 | LS-WMTB-AL (100X15) | 0831503 | 247 | MC 1,5/19-GF-3,81 P20 THR | 1829195 | 19 |
| LS-EMLP (60X30) YE CUS | 0832037 | 259 | LS-EMP-AL (27X18) CUS | 0831948 | 254 | LS-WMTB-AL (100X15) BK | 0831511 | 247 | MC 1,5/19-GF-3,81 P20 THRR104 | 1828837 | 21 |
| LS-EMLP (85,6X54) SR | 0831725 | 257 | LS-EMP-AL (49X15) | 0831663 | 254 | LS-WMTB-AL (100X15) BK CUS | 0831797 | 247 | MC 1,5/20-G-3,81 P20 THR | 1829124 | 18 |
| LS-EMLP (85,6X54) SR CUS | 0832011 | 259 | LS-EMP-AL (49X15) BK | 0831671 | 255 | LS-WMTB-AL (100X15) CUS | 0831789 | 247 | MC 1,5/20-G-3,81 P20 THRR104 | 1828769 | 20 |
| LS-EMLP (85,6X54) WH | 0831698 | 256 | LS-EMP-AL (49X15) BK CUS | 0831957 | 255 | LS-EMSP-AL (29X8) | 0831500 | 247 | MC 1,5/20-GF-3,81 P20 THR | 1829205 | 19 |
| LS-EMLP (85,6X54) WH CUS | 0831984 | 258 | LS-EMP-AL (49X15) CUS | 0831949 | 254 | LS-WMTB-AL (29X8) BK | 0831508 | 247 | MC 1,5/20-GF-3,81 P20 THRR104 | 1828840 | 21 |
| LS-EMLP (85,6X54) YE | 0831752 | 257 | LS-EMP-AL (60X15) | 0831664 | 254 | LS-WMTB-AL (29X8) BK CUS | 0831794 | 247 | MCV 1,5/13-G-3,81 P20 THR | 1828895 | 19 |
| LS-EMLP (85,6X54) YE CUS | 0832038 | 259 | LS-EMP-AL (60X15) BK | 0831672 | 255 | LS-WMTB-AL (29X8) CUS | 0831786 | 247 | MCV 1,5/13-G-3,81 P20 THRR72 | 1828536 | 21 |
| LS-EMLP 24 (30X12) SR | 0831727 | 260 | LS-EMP-AL (60X15) BK CUS | 0831958 | 255 | LS-WMTB-AL (40X15) | 0831501 | 247 | MCV 1,5/13-GF-3,81 P20 THR | 1828976 | 19 |
| LS-EMLP 24 (30X12) SR CUS | 0832013 | 260 | LS-EMP-AL (60X15) CUS | 0831950 | 254 | LS-WMTB-AL (40X15) BK | 0831509 | 247 | MCV 1,5/13-GF-3,81 P20 THRR72 | 1828617 | 21 |
| LS-EMLP 24 (30X12) WH | 0831700 | 260 | LS-EMP-AL (60X30) | 0831665 | 254 | LS-WMTB-AL (40X15) BK CUS | 0831795 | 247 | MCV 1,5/14-G-3,81 P20 THR | 1828905 | 19 |
| LS-EMLP 24 (30X12) WH CUS | 0831986 | 260 | LS-EMP-AL (60X30) BK | 0831673 | 255 | LS-WMTB-AL (40X15) CUS | 0831787 | 247 | MCV 1,5/14-G-3,81 P20 THRR88 | 1828549 | 21 |
| LS-EMLP 24 (30X12) YE | 0831754 | 260 | LS-EMP-AL (60X30) BK CUS | 0831959 | 255 | LS-WMTB-AL (60X15) | 0831502 | 247 | MCV 1,5/14-GF-3,81 P20 THR | 1828989 | 19 |
| LS-EMLP 24 (30X12) YE CUS | 0832040 | 260 | LS-EMP-AL (60X30) CUS | 0831951 | 254 | LS-WMTB-AL (60X15) BK | 0831510 | 247 | MCV 1,5/14-GF-3,81 P20 THRR88 | 1828620 | 21 |
| LS-EMLP 30 (45X10) SR | 0831728 | 261 | LS-EMP-AL (85,6X54) | 0831666 | 254 | LS-WMTB-AL (60X15) BK CUS | 0831796 | 247 | MCV 1,5/15-G-3,81 P20 THR | 1828918 | 19 |
| LS-EMLP 30 (4 | | | | | | | | | | | |

Index

Alphabetical

| Type | Order No. | Page | Type | Order No. | Page | Type | Order No. | Page | Type | Order No. | Page | |
|--------------------------------|-----------|------|-----------------------------|----------------------------|---------|------------------------------|----------------------|---------|--------------------------------|------------------|---------|-----|
| MCV 1,5/18-G-3,81 P20 THR | 1828947 | 19 | | | | PRC 5-FT25-MC6-150 | 1409213 | 77 | PT-IQ-4X1+F-5DC-UT | 2801216 | 311 | |
| MCV 1,5/18-G-3,81 P20 THRR88 | 1828581 | 21 | | | | PRC 5-TC-FS6 8-21 | 1621325 | 76 | PT-IQ-4X1-5DC-P | 2800811 | 311 | |
| MCV 1,5/18-GF-3,81 P20 THR | 1829027 | 19 | N | NLC-035-024D-041-02QRD-05A | 2702031 | 430 | PRC COVER F | 1409236 | 76 | PT-IQ-4X1-5DC-PT | 2801267 | 311 |
| MCV 1,5/18-GF-3,81 P20 THRR88 | 1828662 | 21 | | NLC-040-024D-041-02QRD-05A | 2400079 | 430 | PRC COVER M | 1409237 | 77 | PT-IQ-4X1-5DC-UT | 2801215 | 311 |
| MCV 1,5/19-G-3,81 P20 THR | 1828950 | 19 | | NLC-024-024D-041-02QRD-05A | 2702032 | 433 | PS 6-CT-SD | 3246857 | 171 | PT-IQ-EX-H-PP | 2905024 | 312 |
| MCV 1,5/19-G-3,81 P20 THRR104 | 1828594 | 21 | | NLC-024-024D-041-02QRD-05A | 2400079 | 430 | PS 6-DI-SD | 3246856 | 171 | PT-IQ-EX-L-PP | 2905023 | 312 |
| MCV 1,5/19-GF-3,81 P20 THR | 1829030 | 19 | | NLC-IO-2RTD/UTH-4QTP-01A | 2701671 | 432 | PS 6-VT-SD | 3246858 | 171 | PT/FS 4,8 | 1670497 | 195 |
| MCV 1,5/19-GF-3,81 P20 THRR104 | 1828675 | 21 | NLC-IOX-041-02QRD-05A | 2702032 | 433 | PS-5 | 3030983 | 160 | PTRE 6-2/10 | 3069855 | 93 | |
| MCV 1,5/20-G-3,81 P20 THR | 1828963 | 19 | NLC-OP1-MKT-BASE | 2701250 | 431 | PS-5/2,3MM RD | 3038723 | 158 | PTRE 6-2/12 | 3069861 | 93 | |
| MCV 1,5/20-G-3,81 P20 THRR104 | 1828604 | 21 | NLC-OP2-LCD-076-4X20 | 2701945 | 431 | PS-6 | 3030996 | 162 | PTRE 6-2/14 | 3069863 | 93 | |
| MCV 1,5/20-GF-3,81 P20 THR | 1829043 | 19 | NLC-PC/SERIAL-CBL 2M | 2701234 | 430 | PSBJ-URTK 6 BK | 3026447 | 99 | PTRE 6-2/15 | 3069864 | 93 | |
| MCV 1,5/20-GF-3,81 P20 THRR104 | 1828688 | 21 | | | | PSBJ-URTK 6 BN | 3026971 | 99 | PTRE 6-2/17 | 3069866 | 93 | |
| ME 17,5 TBUS 1,5/ 5-ST-3,81 GN | 2209561 | 337 | | | | PSBJ-URTK 6 BU | 3026434 | 99 | PTRE 6-2/19 | 3069868 | 93 | |
| ME 17,5 TBUS 1,5/4P1S KMGY | 2201731 | 39 | P | P-CO | 3036796 | 158 | PSBJ-URTK 6 FARBLOS | 3026450 | 99 | PTRE 6-2/20 | 3069869 | 93 |
| ME 17,5 TBUS ADAPTER KMGY | 2201757 | 39 | | P-DI | 3036783 | 158 | PSBJ-URTK 6 GN | 3026418 | 99 | PTRE 6-2/21 | 3069870 | 93 |
| ME 18,8 TBUS 1,5/5-ST-3,81KMGY | 2201813 | 35 | | P-FIX | 3038956 | 158 | PSBJ-URTK 6 GY | 3026612 | 99 | PTRE 6-2/22 | 3069871 | 93 |
| ME 22,5 TBUS 1,5/ 5-ST-3,81 GN | 2707437 | 358 | | P-FU 5X20 | 3036806 | 164 | PSI-CAB-GSM/UMTS- 5M | 2900980 | 394 | PTRE 6-2/25 | 3069874 | 93 |
| ME 22,5 TBUS 1,5/4P1S KMGY | 2201732 | 39 | | P-FU 5X20 LA 250-EX | 3036836 | 163 | PSI-CAB-GSM/UMTS-10M | 2900981 | 394 | PTRE 6-2/A14 | 3069452 | 109 |
| ME 22,5 TBUS ADAPTER KMGY | 2201756 | 39 | P-FU 5X20 LED 24-5 | 3209248 | 158 | PSI-GSM/UMTS-ANT-OMNI-2-5 | 2900982 | 394 | PTRE 6-2/A7 | 3069449 | 103 | |
| ME 6,2 TBUS-2 1,5/5-ST-3,81 GN | 2869728 | 336 | P-FU 5X20 LED 24-EX | 3036821 | 163 | PSI-GSM/UMTS-QB-ANT | 2313371 | 394 | PTRE 6-2/B14 | 3069453 | 111 | |
| ME 6,2 TBUS-2 1,5/5-ST-3,81 GY | 2695439 | 336 | P-FU 5X20 LED 250-5 | 3209264 | 158 | PSK APS7004IOL | 2700710 | 350 | PTRE 6-2/B19 | 3069455 | 115 | |
| ME-IO 18,8 B/FE 3/9U TBUS 7035 | 2201963 | 34 | P-FU 5X20 LED 60-5 | 3209251 | 158 | PSM-KA 9 SUB 25/BB/2METER | 2761059 | 391 | PTRE 6-2/B7 | 3069450 | 105 | |
| ME-IO 18,8 B/FE 9/9U TBUS 7035 | 2201962 | 34 | P-FU 5X20 LED 60-EX | 3036823 | 163 | PSM-KA9SUB9/BB/2METER | 2799474 | 391 | PTRE 6-2/C14 | 3069454 | 113 | |
| ME-IO 18,8 B/FE 7/9U TBUS 7035 | 2201961 | 34 | P-FU 5X20-5 | 3209235 | 158 | PSR-PIP-24DC/MXF1/4X1/2X2/B | 2903253 | 401 | PTRE 6-2/C19 | 3069456 | 117 | |
| ME-IO 18,8 B/FE 9/9U TBUS 7035 | 2201960 | 34 | P-FU 5X20-EX | 3036807 | 163 | PSR-PIP-24DC/MXF2/4X1/2X2/B | 2903256 | 401 | PTRE 6-2/D19 | 3069457 | 119 | |
| ME-IO 18,8 C 2U 7035 | 2201799 | 35 | P-FU 6,3X32 LA 250-EX | 3046525 | 163 | PSR-PIP-24DC/MXF3/4X1/2X2/B | 2903259 | 401 | PTRE 6-2/E7 | 3069451 | 107 | |
| ME-IO 18,8 C 3U 7035 | 2201800 | 35 | P-FU 6,3X32 LED 24-EX | 3046509 | 163 | PSR-PIP-24DC/MXF4/4X1/2X2/B | 2903262 | 401 | PTRE 6-2/F19 | 3069458 | 121 | |
| ME-IO 18,8 C 3U S1 7035 | 2201801 | 35 | P-FU 6,3X32 LED 60-EX | 3046512 | 163 | PSR-SCP- 24DC/MXF1/4X1/2X2/B | 2902725 | 400 | PTRE 6-2/G19 | 3069459 | 123 | |
| ME-IO 18,8 C 4U 7035 | 2201802 | 35 | P-FU 6,3X32-EX | 3046499 | 163 | PSR-SCP- 24DC/TS/M | 2986012 | 402 | PTRE 6-2/H19 | 3069460 | 125 | |
| ME-IO 18,8 C 5U 7035 | 2201803 | 35 | PACT RCP-4000A-1A-D140 | 2904922 | 353 | PSR-SCP- 24DC/TS/SDOR4/4X1 | 2986096 | 402 | PTRE 6-2/I19 | 3069461 | 127 | |
| ME-IO 18,8 C 6U 7035 | 2201804 | 35 | PACT RCP-4000A-1A-D190 | 2904923 | 353 | PSR-SCP-24DC/MXF2/4X1/2X2/B | 2903254 | 400 | PTSM 0,5/ 1-2,5-H SMD WH L R24 | 1840035 | 23 | |
| ME-IO 18,8 C 7U 7035 | 2201805 | 35 | PACT RCP-4000A-1A-D95 | 2904921 | 353 | PSR-SCP-24DC/MXF3/4X1/2X2/B | 2903257 | 400 | PTSM 0,5/ 2-HTB-2,5-SMD WH R32 | 1830126 | 23 | |
| ME-SAS | 2853899 | 391 | PACT RCP-CLAMP | 2904895 | 353 | PSR-SCP-24DC/MXF4/4X1/2X2/B | 2903260 | 400 | PTSM 0,5/ 2-HV-2,5-SMD WH R32 | 1778696 | 23 | |
| MICROFOX-SP-1 | 1212487 | 44 | PAI-4-N GY | 3032871 | 162 | PSR-SPP- 24DC/TS/M | 2986025 | 402 | PTSM 0,5/ 3-HTB-2,5-SMD WH R32 | 1830139 | 23 | |
| MINI FD BLUETOOTH | 0830986 | 289 | PBR 42A BU | 2201916 | 38 | PSR-SPP- 24DC/TS/SDOR4/4X1 | 2986106 | 402 | PTSM 0,5/ 3-HV-2,5-SMD WH R32 | 1778706 | 23 | |
| MINI MCR-2-FM-RC | 2904504 | 338 | PBR 42A KMGY | 2201917 | 38 | PSR-SPP-24DC/MXF1/4X1/2X2/B | 2902726 | 400 | PTSM 0,5/ 4-HTB-2,5-SMD WH R44 | 1830142 | 23 | |
| MINI MCR-2-FM-RC-PT | 2904508 | 338 | PBR 42A RD | 2201915 | 38 | PSR-SPP-24DC/MXF2/4X1/2X2/B | 2903255 | 400 | PTSM 0,5/ 4-HTB-2,5-SMD WH R44 | 1778719 | 23 | |
| MINI MCR-2-I-I | 2901998 | 328 | PC-FTP-TRI | 3069898 | 99 | PSR-SPP-24DC/MXF3/4X1/2X2/B | 2903258 | 400 | PTSM 0,5/ 5-HTB-2,5-SMD WH R44 | 1830155 | 23 | |
| MINI MCR-2-I-I-PT | 2901999 | 328 | PC-UTWE-TRI | 3069897 | 99 | PSR-SPP-24DC/MXF4/4X1/2X2/B | 2903261 | 400 | PTSM 0,5/ 5-HV-2,5-SMD WH R44 | 1778722 | 23 | |
| MINI MCR-2-I-U | 2902000 | 328 | PCO 17,5-L KMGY | 2201684 | 38 | PSR-TBUS | 2890425 | 402 | PTSM 0,5/ 6-HTB-2,5-SMD WH R44 | 1830168 | 23 | |
| MINI MCR-2-I-U-PT | 2902001 | 328 | PCO 22,5-L KMGY | 2201685 | 38 | PT 1,5/S-MT | 3210301 | 156 | PTSM 0,5/ 6-HV-2,5-SMD WH R44 | 1778735 | 23 | |
| MINI MCR-2-I-U-PT | 2902002 | 328 | PLC-LOGIC-STARTERKIT1 | 2905504 | 359 | PT 1,5/S-MT BU | 3210302 | 156 | PTSM 0,5/ 7-HTB-2,5-SMD WH R44 | 1830171 | 23 | |
| MINI MCR-2-I-U-PT | 2902003 | 328 | PLC-OPT- 24DC/230AC/2,4/ACT | 2904632 | 366 | PT 1,5/S-MTD | 3210308 | 156 | PTSM 0,5/ 7-HV-2,5-SMD WH R44 | 1778748 | 23 | |
| MINI MCR-2-I-U-PT | 2902004 | 328 | PLC-OSC- 24DC/230AC/2,4/ACT | 2904631 | 366 | PT 1,5/S-MTD BU | 3210309 | 156 | PTSM 0,5/ 8-HTB-2,5-SMD WH R44 | 1830184 | 23 | |
| MINI MCR-2-I-U-PT | 2902005 | 328 | PLC-V8C/CAB/TBUS/0,3M | 2905263 | 358 | PT 1,5/S-QUATTRO-MT | 3210321 | 157 | PTSM 0,5/ 8-HV-2,5-SMD WH R44 | 1778751 | 23 | |
| MINI MCR-2-I-U-PT | 2902006 | 336 | PLC-V8C/PT-24DC/BM | 2905135 | 357 | PT 1,5/S-QUATTRO-MT BU | 3210322 | 157 | PTT 1,5/S-2L | 3210356 | 157 | |
| MINI MCR-2-I-U-PT | 2902007 | 336 | PLC-V8C/PT-24DC/EM | 2905137 | 357 | PT 1,5/S-QUATTRO-MTD | 3210328 | 157 | PTT 1,5/S-2L BU | 3210357 | 157 | |
| MINI MCR-2-I-U-PT | 2902008 | 328 | PLC-V8C/PT-24DC/SAM | 2905136 | 356 | PT 1,5/S-QUATTRO-MTD BU | 3210329 | 157 | PTT 1,5/S-2MT | 3210351 | 157 | |
| MINI MCR-2-I-U-PT | 2902009 | 330 | PLC-V8C/SC-24DC/BM | 2903094 | 357 | PT 1,5/S-TWIN-MT | 3210311 | 157 | PTT 1,5/S-2MT BU | 3210352 | 157 | |
| MINI MCR-2-I-U-PT | 2902010 | 330 | PLC-V8C/SC-24DC/EM | 2903095 | 357 | PT 1,5/S-TWIN-MT BU | 3210312 | 157 | PTT 1,5/S-LMT | 3210341 | 157 | |
| MINI MCR-2-I-U-PT | 2902011 | 330 | PLC-V8C/SC-24DC/SAM | 2905082 | 356 | PT 1,5/S-TWIN-MTD | 3210317 | 157 | PTT 1,5/S-LMT BU | 3210342 | 157 | |
| MINI MCR-2-I-U-PT | 2902012 | 330 | PMST (9X38) | 0830960 | 285 | PT 1,5/S-TWIN-MTD BU | 3210319 | 157 | PTT 2,5-2L | 3210267 | 159 | |
| MINI MCR-2-I-U-PT | 2902013 | 330 | PMST (9X38) BK | 0830965 | 285 | PT-IQ-1X2-EX-24DC-P | 2801514 | 312 | PTT 2,5-2L BU | 3210268 | 159 | |
| MINI MCR-2-I-U-PT | 2902014 | 330 | PMST (9X38) BN | 0830968 | 285 | PT-IQ-1X2-EX-24DC-UT | 2801512 | 312 | PTT 2,5-2MT | 3210258 | 159 | |
| MINI MCR-2-I-U-PT | 2902015 | 332 | PMST (9X38) BU | 0830969 | 285 | PT-IQ-2X2+F-48DC-PT | 2801266 | 311 | PTT 2,5-2MT BU | 3210265 | 159 | |
| MINI MCR-2-I-U-PT | 2902016 | 332 | PMST (9X38) GN | 0830961 | 285 | PT-IQ-2X2+F-48DC-PT | 2800987 | 311 | PTT 2,5-LMT | 3210251 | 159 | |
| MINI MCR-2-I-U-PT | 2902017 | 332 | PMST (9X38) GY | 0830963 | 285 | PT-IQ-2X2+F-5DC-PT | 2801260 | 311 | PTT 2,5-LMT BU | 3210257 | 159 | |
| MINI MCR-2-U-I0 | 2902022 | 328 | PMST (9X38) OG | 0830966 | 285 | PT-IQ-2X2+5-5DC-UT | 2800809 | 311 | PTT 2,5-LTG | 3210230 | 158 | |
| MINI MCR-2-U-I0-PT | 2902023 | 328 | PMST (9X38) RD | 0830962 | 285 | PT-IQ-2X2-48DC-P | 2800810 | 310 | PTT 2,5-LTG BU | 3210270 | 158 | |
| MINI MCR-2-U-I4 | 2902029 | 328 | PMST (9X38) VT | 0830967 | 285 | PT-IQ-2X2-48DC-PT | 2801265 | 310 | PTTBS 2,5-2MTB | 3210400 | 161 | |
| MINI MCR-2-U-I4-PT | 2902030 | 328 | PMST (9X38) YE | 0830964 | 285 | PT-IQ-2X2-48DC-UT | 2800986 | 310 | PTTBS 2,5-2MTB BU | 3210401 | 161 | |
| MINI MCR-2-U-U | 2902042 | 328 | PRC 3-FC-FS6 8-12 | 1410658 | 76 | PT-IQ-2X2-5DC-P | 2800802 | 310 | PTTBS 2,5-2TGB | 3210402 | 160 | |
| MINI MCR-2-U-U-PT | 2902043 | 328 | PRC 3-FC-FS6 8-21 | 1410661 | 76 | PT-IQ-2X2-5DC-PT | 2801259 | 310 | PTWE 6-2/10 | 3069833 | 92 | |
| MINI MCR-2-U-U-UI | 2902037 | 326 | PRC 3-FC-FS6 12-16 | 1409217 | 76 | PT-IQ-2X2-5DC-UT | 2800807 | 310 | PTWE 6-2/12 | 3069835 | 92 | |
| MINI MCR-2-U-U-UI-C | 2902036 | 326 | PRC 3-FC-FS6 16-21 | 1410659 | 76 | PT-IQ-2X2-EX-24DC-P | 2801515 | 312 | PTWE 6-2/14 | 3069837 | 92 | |
| MINI MCR-2-UI-UI-PT | 2902040 | 326 | PRC 3-FT25-MC | 1409218 | 77 | PT-IQ-2X2-EX-24DC-UT | 2801513 | 312 | PTWE 6-2/15 | 3069838 | 92 | |
| MINI MCR-2-UI-UI-PT-C | 2902039 | 326 | PRC 3-FT25-MC2,5-150 | 1409219 | 77 | PT-IQ-3-HF-F-12DC-PT | 2801289 | 313 | PTWE 6-2/17 | 3069840 | 92 | |
| MINI-PS-100-240AC/24DC/1,5/EX | 2866653 | 337 | PRC 3-FT25-MC4-150 | 1409220 | 77 | PT-IQ-3-HF-F-12DC-UT | 2800995 | 313 | PTWE 6-2/19 | 3069842 | 92 | |
| MINI-SYS-PS-100-240AC/24DC/1,5 | 2866983 | 337 | PRC 3-FT25-MC6-150 | 1409221 | 77 | PT-IQ-3-HF-12DC-P | 2800784 | 313 | PTWE 6-2/20 | 3069843 | 92 | |
| MPB 18/1-57 | 2809328 | 156 | PRC 3-TC-FS6 8-21 | 1621326 | 76 | PT-IQ-3-HF-12DC-UT | 2801288 | 313 | PTWE 6-2/21 | 3069844 | 92 | |
| MPS-IH RD | 0201676 | 156 | PRC 5-FC-FS6 8-12 | 1410629 | 76 | PT-IQ-3-HF-12DC-PT | 2800786 | 313 | PTWE 6-2/22 | 3069845 | 92 | |
| MPS-MT | 0201744 | 156 | PRC 5-FC-FS6 8-21 | 1410656 | 76 | PT-IQ-3-PB+F-PT | 2801287 | 313 | PTWE 6-2/25 | 3069848 | 92 | |
| | | | PRC 5-FC-FS6 12-16 | 1409205 | 76 | PT-IQ-3-PB+F-UT | 28 | | | | | |

| Type | Order No. | Page | Type | Order No. | Page | Type | Order No. | Page | Type | Order No. | Page |
|--------------------------------|-----------|------|-------------------------------|-----------|------|--------------------------------|-----------|------|--------------------------------|-----------|------|
| PTWE 6-2/B14 | 3069440 | 110 | QPD W 4PE2,5 6-11 M25 0,5 EX | 1411387 | 192 | SAC-2P- 5,0-PUR/SUSFS | 1410750 | 181 | SACC-DSI-M12FSB-5P-M16XL/0,5 | 1411587 | 54 |
| PTWE 6-2/B19 | 3069442 | 114 | QPD W 4PE2,5 6-11 M25 1,0 EX | 1411388 | 192 | SAC-2P-10,0-PUR/DTFS | 1410727 | 182 | SACC-DSI-M12FSD-4P-M16XL/0,5 | 1411585 | 54 |
| PTWE 6-2/B7 | 3069437 | 104 | QPD W 4PE2,5 6-11 M25 DT BK | 1411432 | 191 | SAC-2P-10,0-PUR/DTFS-1L | 1410731 | 182 | SACC-DSI-M12FSS-3P-M16/0,5 PE | 1411652 | 58 |
| PTWE 6-2/C14 | 3069441 | 112 | QPD W 4PE2,5 6-11 M25 DT GY | 1411434 | 191 | SAC-2P-10,0-PUR/DTFS-1L-S | 1410735 | 183 | SACC-DSI-M12FSS-4P-M16XL/0,5PE | 1411598 | 56 |
| PTWE 6-2/C19 | 3069443 | 116 | QPD W 4PE2,5 6-11 M25 FC EX | 1411389 | 192 | SAC-2P-10,0-PUR/SUSFS | 1410751 | 181 | SACC-DSI-M12FST-4P-M16XL/0,5 | 1411599 | 56 |
| PTWE 6-2/D19 | 3069444 | 118 | QPD W 4PE2,5 9-16 M20 0,5 EX | 1411397 | 192 | SAC-2P-MSB-FSB SCO/910/... | 1538092 | 396 | SACC-DSI-M12MS-12P-M16XL/0,5 | 1411596 | 54 |
| PTWE 6-2/E7 | 3069438 | 106 | QPD W 4PE2,5 9-16 M20 1,0 EX | 1411398 | 192 | SAC-2P-MSB/ 1,0-910/FSB SCO | 1518122 | 396 | SACC-DSI-M12MS-17P-M16XL/0,5 | 1411597 | 54 |
| PTWE 6-2/F19 | 3069445 | 120 | QPD W 4PE2,5 9-16 M20 FC EX | 1411399 | 192 | SAC-2P-SUSMS/ 0,3-PUR/SUSFS | 1410757 | 181 | SACC-DSI-M12MS-4P-M16XL/0,5 | 1411591 | 54 |
| PTWE 6-2/G19 | 3069446 | 122 | QPD W 4PE2,5 9-16 M25 0,5 EX | 1411390 | 192 | SAC-2P-SUSMS/ 0,6-PUR/SUSFS | 1410759 | 181 | SACC-DSI-M12MS-5P-M16XL/0,5 | 1411593 | 54 |
| PTWE 6-2/H19 | 3069447 | 124 | QPD W 4PE2,5 9-16 M25 1,0 EX | 1411391 | 192 | SAC-2P-SUSMS/ 1,5-PUR | 1410752 | 181 | SACC-DSI-M12MS-8P-M16XL/0,5 | 1411595 | 54 |
| PTWE 6-2/I19 | 3069448 | 126 | QPD W 4PE2,5 9-16 M25 DT BK | 1411433 | 191 | SAC-2P-SUSMS/ 1,5-PUR/SUSFS | 1410760 | 181 | SACC-DSI-M12MSB-5P-M16XL/0,5 | 1411594 | 54 |
| PV-MI-CABLE SPLICE 3P | 1812403 | 72 | QPD W 4PE2,5 9-16 M25 DT GY | 1411435 | 191 | SAC-2P-SUSMS/ 3,0-PUR | 1410753 | 181 | SACC-DSI-M12MSD-4P-M16XL/0,5 | 1411592 | 54 |
| PV-MI-CABLE TERMINATOR 3P | 1812416 | 72 | QPD W 4PE2,5 9-16 M25 FC EX | 1411392 | 192 | SAC-2P-SUSMS/ 3,0-PUR/SUSFS | 1410761 | 181 | SACC-DSI-M12MSS-3P-M16/0,5 PE | 1411653 | 58 |
| PV-MI-YC-1,15-3-12-NA-0,50-OE | 1706518 | 70 | QPD W 4PE6,0 12-20 M25 0,5 BK | 1410394 | 193 | SAC-2P-SUSMS/ 5,0-PUR | 1410755 | 181 | SACC-DSI-M12MSS-4P-M16XL/0,5PE | 1411600 | 56 |
| PV-MI-YC-1,15-3-25-EU-0,50-OE | 1621351 | 70 | QPD W 4PE6,0 12-20 M25 0,5 GY | 1410401 | 193 | SAC-2P-SUSMS/10,0-PUR | 1410756 | 181 | SACC-DSI-M12MST-4P-M16XL/0,5 | 1411604 | 56 |
| PV-MI-YC-CARRIER-CAP-TP | 1706808 | 70 | QPD W 4PE6,0 12-20 M25 1,0 BK | 1410395 | 193 | SAC-3P- 1,0-PVC/FRS PE SCO | 1411648 | 184 | SACC-E-M12FS-12P-M16XL/0,5 | 1411574 | 55 |
| PV-MI-YC-CARRIER-CAP-TS | 1706599 | 70 | QPD W 4PE6,0 12-20 M25 1,0 GY | 1410402 | 193 | SAC-3P- 1,0-PVC/FSB PE SCO | 1411644 | 184 | SACC-E-M12FS-17P-M16XL/0,5 | 1411576 | 55 |
| PV-MI-YC-GC-P-1,00-3-12-NA SET | 1707091 | 70 | QPD W 4PE6,0 9-14 M25 0,5 BK | 1410392 | 193 | SAC-3P- 1,5-PUO/A-1L-Z OD | 1407287 | 180 | SACC-E-M12FS-4P-M16XL/0,5 | 1411568 | 55 |
| PV-MI-YC-GC-P-1,00-3-25-EU SET | 1621349 | 70 | QPD W 4PE6,0 9-14 M25 0,5 GY | 1410399 | 193 | SAC-3P- 1,5-PUR/A-1L-R-ES 4A | 1400827 | 177 | SACC-E-M12FS-5P-M16XL/0,5 | 1411571 | 55 |
| PV-MI-YC-GC-S-1,00-3-12-NA SET | 1707092 | 71 | QPD W 4PE6,0 9-14 M25 1,0 BK | 1410393 | 193 | SAC-3P- 1,5-PUR/B-1L-R-ES | 1401294 | 177 | SACC-E-M12FS-8P-M16XL/0,5 | 1411573 | 55 |
| PV-MI-YC-GC-S-1,00-3-25-EU SET | 1621350 | 71 | QPD W 4PE6,0 9-14 M25 1,0 GY | 1410400 | 193 | SAC-3P- 1,5-PUR/BI-1L-R-ES | 1401340 | 178 | SACC-E-M12FSB-5P-M16XL/0,5 | 1411572 | 55 |
| PV-MI-YC-PATCH-1,00-3-12-NA | 1707090 | 71 | QPD W 4PE6,0 M25 0,5 BK | 1410396 | 193 | SAC-3P- 1,5-PUO/A-1L-Z OD | 1401434 | 178 | SACC-E-M12MSS-4P-M16XL/0,5 | 1411569 | 55 |
| PV-MI-YC-PATCH-1,00-3-25-EU | 1621352 | 71 | QPD W 4PE6,0 M25 0,5 GY | 1410403 | 193 | SAC-3P- 1,5-PUR/CI-1L-R-ES | 1401466 | 179 | SACC-E-M12FSS-3P-M16/0,5 PE | 1411654 | 58 |
| PV-MI-YC-PROTECTION-CAP-TP | 1706610 | 70 | QPD W 4PE6,0 M25 1,0 BK | 1410397 | 193 | SAC-3P- 2,0-PVC/FRS PE SCO | 1411649 | 184 | SACC-E-M12FSS-4P-M16XL/0,5 PE | 1411605 | 57 |
| PV-MI-YC-PROTECTION-CAP-TS | 1706515 | 70 | QPD W 4PE6,0 M25 1,0 GY | 1410404 | 193 | SAC-3P- 2,0-PVC/FSB PE SCO | 1411645 | 184 | SACC-E-M12FST-4P-M16XL/0,5 | 1411606 | 57 |
| PWO 16-UW | 1844387 | 29 | QSS 15 | 1641992 | 195 | SAC-3P- 3,0-PUR/A-1L-Z OD | 1407288 | 180 | SACC-E-M12MSS-4P-M16XL/0,5 | 1411582 | 55 |
| PWO 16-UW/S | 1844390 | 29 | QSS 19 | 1670895 | 195 | SAC-3P- 3,0-PUR/A-1L-R-ES 4A | 1401131 | 177 | SACC-E-M12MS-17P-M16XL/0,5 | 1411583 | 55 |
| | | | QSS 22 | 1670206 | 195 | SAC-3P- 3,0-PUR/B-1L-R-ES | 1401295 | 177 | SACC-E-M12MS-4P-M16XL/0,5 | 1411577 | 55 |
| | | | QSS 24 | 1670219 | 195 | SAC-3P- 3,0-PUR/BI-1L-R-ES | 1401350 | 178 | SACC-E-M12MS-5P-M16XL/0,5 | 1411579 | 55 |
| | | | QSS 27 | 1670646 | 195 | SAC-3P- 3,0-PUR/C-1L-R-ES | 1401435 | 178 | SACC-E-M12MS-8P-M16XL/0,5 | 1411581 | 55 |
| | | | QTC 2,5-QUATTRO | 3206446 | 173 | SAC-3P- 3,0-PUR/CI-1L-R-ES | 1401542 | 179 | SACC-E-M12MSB-5P-M16XL/0,5 | 1411580 | 55 |
| | | | QTC 2,5-QUATTRO BU | 3206447 | 173 | SAC-3P- 5,0-PUO/A-1L-Z OD | 1407289 | 180 | SACC-E-M12MSD-4P-M16XL/0,5 | 1411578 | 55 |
| | | | | | | SAC-3P- 5,0-PUR/A-1L-R-ES 4A | 1401136 | 177 | SACC-E-M12MSS-3P-M16/0,5 PE | 1411655 | 58 |
| | | | | | | SAC-3P- 5,0-PUR/B-1L-R-ES | 1401338 | 177 | SACC-E-M12MSS-4P-M16XL/0,5 PE | 1411607 | 57 |
| | | | | | | SAC-3P- 5,0-PUR/BI-1L-R-ES | 1401358 | 178 | SACC-E-M12MST-4P-M16XL/0,5 | 1411608 | 57 |
| | | | | | | SAC-3P- 5,0-PUR/C-1L-R-ES | 1401448 | 178 | SACC-M12MRD-4CT SH PN | 1411047 | 185 |
| | | | | | | SAC-3P- 5,0-PUR/CI-1L-R-ES | 1401544 | 179 | SACC-M12MSD-4CT SH PN | 1411046 | 185 |
| | | | | | | SAC-3P- 5,0-PVC/FRS PE SCO | 1411650 | 184 | SAFE AI | 2400057 | 406 |
| | | | | | | SAC-3P- 5,0-PVC/FSB PE SCO | 1411646 | 184 | SCRT 9X16-27 | 0830970 | 285 |
| | | | | | | SAC-3P-10,0-PUO/A-1L-Z OD | 1407290 | 180 | SCRT 9X25-40 | 0830971 | 285 |
| | | | | | | SAC-3P-10,0-PUR/A-1L-R-ES 4A | 1401168 | 177 | SCRT 9X40-60 | 0830972 | 285 |
| | | | | | | SAC-3P-10,0-PUR/BI-1L-R-ES | 1401339 | 177 | SCRT 9X60-80 | 0830973 | 285 |
| | | | | | | SAC-3P-10,0-PUR/BI-1L-R-ES | 1401359 | 178 | SCRT 9X80-100 | 0830974 | 285 |
| | | | | | | SAC-3P-10,0-PUR/CI-1L-R-ES | 1401465 | 178 | SCRT 9X100-120 | 0830975 | 285 |
| | | | | | | SAC-3P-10,0-PUR/CI-1L-R-ES | 1401617 | 179 | SCRT 9X140-160 | 0830976 | 285 |
| | | | | | | SAC-3P-10,0-PVC/FRS PE SCO | 1411651 | 184 | SCRT 9X160-180 | 0830977 | 285 |
| | | | | | | SAC-3P-10,0-PVC/FRS PE SCO | 1411647 | 184 | SCRT 9X180-200 | 0830978 | 285 |
| | | | | | | SAC-3P-MRS/ 1,0-PVC PE SCO | 1411640 | 184 | SD FLASH 2GB | 2988162 | 387 |
| | | | | | | SAC-3P-MRS/ 2,0-PVC PE SCO | 1411641 | 184 | SD FLASH 2GB EMWISE EXTENDED | 2701747 | 348 |
| | | | | | | SAC-3P-MRS/ 5,0-PVC PE SCO | 1411642 | 184 | SD FLASH 2GB EMWISE IMP ANALOG | 2701746 | 348 |
| | | | | | | SAC-3P-MRS/10,0-PVC PE SCO | 1411643 | 184 | SD FLASH 2GB EMWISE IMPULS | 2701745 | 348 |
| | | | | | | SAC-3P-MSS/ 1,0-PVC PE SCO | 1411636 | 184 | SD FLASH 512MB | 2988146 | 380 |
| | | | | | | SAC-3P-MSS/ 2,0-PVC PE SCO | 1411637 | 184 | SD FLASH 512MB ILDLF FLEX | 2701873 | 349 |
| | | | | | | SAC-3P-MSS/ 5,0-PVC PE SCO | 1411638 | 184 | SD FLASH 512MB MODULAR MUX | 2701872 | 429 |
| | | | | | | SAC-3P-MSS/10,0-PVC PE SCO | 1411639 | 184 | SEALING PLUG 10X16 RD | 1400284 | 195 |
| | | | | | | SAC-4PY-MT/2XFT VP | 1410632 | 186 | SEALING PLUG 14X22 RD | 1400270 | 195 |
| | | | | | | SAC-5P- 1,5-PUO/AD-2L OD | 1407291 | 180 | SF-08KP010 | 1621574 | 66 |
| | | | | | | SAC-5P- 2,0-92X/M12FS SH OD | 1410474 | 187 | SF-08KP020 | 1621575 | 66 |
| | | | | | | SAC-5P- 3,0-PUO/AD-2L OD | 1407292 | 180 | SF-08KS010 | 1621571 | 66 |
| | | | | | | SAC-5P- 5,0-92X/M12FS SH OD | 1410494 | 187 | SF-08KS020 | 1621573 | 66 |
| | | | | | | SAC-5P- 5,0-PUO/AD-2L OD | 1407293 | 180 | SF-20KP021 | 1621579 | 66 |
| | | | | | | SAC-5P-10,0-92X/M12FS SH OD | 1410496 | 187 | SF-20KP022 | 1621580 | 66 |
| | | | | | | SAC-5P-10,0-PUO/AD-2L OD | 1407294 | 180 | SF-20KP023 | 1621581 | 66 |
| | | | | | | SAC-5P-M12FS CAN TR | 1529344 | 396 | SF-20KS021 | 1621576 | 66 |
| | | | | | | SAC-5P-M12FS PB TR | 1403911 | 396 | SF-20KS022 | 1621577 | 66 |
| | | | | | | SAC-5P-M12MS CAN TR | 1507816 | 396 | SF-20KS023 | 1621578 | 66 |
| | | | | | | SAC-5P-M12MS PB TR | 1507803 | 396 | SF-BIT-HEX 3-50 | 1212647 | 222 |
| | | | | | | SAC-5P-M12MS/ 2,0-92X SH OD | 1410471 | 187 | SF-M BH | 1212070 | 222 |
| | | | | | | SAC-5P-M12MS/ 5,0-92X SH OD | 1410472 | 187 | SF-SL 0,6X3,5-100 S-VDE | 1212587 | 170 |
| | | | | | | SAC-5P-M12MS/10,0-92X SH OD | 1410473 | 187 | SF-SL 0,8X4,0-100 | 1212551 | 92 |
| | | | | | | SAC-5P-M12MS/2,0-92X/M12FSSHOD | 1410467 | 187 | SH-8EPC58A8L1B1S | 1621533 | 62 |
| | | | | | | SAC-5P-M12MS/5,0-92X/M12FSSHOD | 1410470 | 187 | SH-8EPC58A8L2B2S | 1621532 | 62 |
| | | | | | | SAC-5P-MS-FS SCO/920/... | 1538157 | 396 | SH-8EPC58A8L3B3S | 1621531 | 62 |
| | | | | | | SAC-5P-MS/ 1,0-920/FS SCO | 1518274 | 396 | SH-8EPC58A8L4B4S | 1621530 | 62 |
| | | | | | | SACC-CC1,0-T-0,50-M AU PU100 | 1412351 | 185 | SH-8EPC58A8L5B5S | 1621529 | 62 |
| | | | | | | SACC-DSI-M12FS-12P-M16XL/0,5 | 1411589 | 54 | SH-8EPC58A9L1B1S | 1621533 | 62 |
| | | | | | | SACC-DSI-M12FS-17P-M16XL/0,5 | 1411590 | 54 | SH-8EPC58A9L2B2S | 1621532 | 62 |
| | | | | | | SACC-DSI-M12FS-4P-M16XL/0,5 | 1411584 | 54 | SH-8EPC58A9L3B3S | 1621531 | 62 |
| | | | | | | SACC-DSI-M12FS-5P-M16XL/0,5 | 1411586 | 54 | SH-8EPC58A9L4B4S | 1621530 | 62 |
| | | | | | | SACC-DSI-M12FS-8P-M16XL/0,5 | 1411588 | 54 | SH-8EPC58A9L5B5S | 1621529 | 62 |
| | | | | | | | | | | | |

Index

Alphabetical

| Type | Order No. | Page | Type | Order No. | Page | Type | Order No. | Page | Type | Order No. | Page |
|---------------------------|-----------|------|-------------------------------|-----------|------|-------------------------------|-----------|------|--------------------------------|-----------|------|
| SH-8EPC58AAC00S | 1621561 | 65 | SPT-SMD 1,5/ 6-V-3,81 R44 | 1824239 | 7 | SPT-THR 1,5/ 3-V-5,0 P26 | 1822545 | 13 | SPT-THR 1,5/ 8-V-5,0 P26 | 1822590 | 13 |
| SH-8EPC58AAD00S | 1621565 | 65 | SPT-SMD 1,5/ 6-V-5,0 R44 | 1824349 | 9 | SPT-THR 1,5/ 3-V-5,08 P20 R32 | 1823531 | 13 | SPT-THR 1,5/ 8-V-5,08 P20 R88 | 1823586 | 13 |
| SH-8EPC58AWA00S | 1621569 | 64 | SPT-SMD 1,5/ 6-V-5,08 R44 | 1824459 | 9 | SPT-THR 1,5/ 3-V-5,08 P26 | 1822655 | 13 | SPT-THR 1,5/ 8-V-5,08 P26 | 1822707 | 13 |
| SH-8EPS48A8LB1S | 1621538 | 62 | SPT-SMD 1,5/ 7-H-3,5 R44 | 1824572 | 7 | SPT-THR 1,5/ 4-H-3,5 P20 R32 | 1823654 | 11 | SPT-THR 1,5/ 9-H-3,5 P20 R72 | 1823706 | 11 |
| SH-8EPS48A8LB2S | 1621537 | 62 | SPT-SMD 1,5/ 7-H-3,81 R44 | 1824682 | 7 | SPT-THR 1,5/ 4-H-3,5 P26 | 1822778 | 10 | SPT-THR 1,5/ 9-H-3,5 P26 | 1822820 | 10 |
| SH-8EPS48A8LB3S | 1621536 | 62 | SPT-SMD 1,5/ 7-H-5,0 R88 | 1824792 | 9 | SPT-THR 1,5/ 4-H-3,81 P20 R32 | 1823764 | 11 | SPT-THR 1,5/ 9-H-3,81 P20 R72 | 1823816 | 11 |
| SH-8EPS48A8LB4S | 1621535 | 62 | SPT-SMD 1,5/ 7-H-5,08 R88 | 1824909 | 9 | SPT-THR 1,5/ 4-H-3,81 P26 | 1822888 | 10 | SPT-THR 1,5/ 9-H-3,81 P26 | 1822930 | 10 |
| SH-8EPS48A8LDLS | 1621534 | 62 | SPT-SMD 1,5/ 7-V-3,5 R44 | 1824132 | 7 | SPT-THR 1,5/ 4-H-5,0 P20 R32 | 1823874 | 13 | SPT-THR 1,5/ 9-H-5,0 P20 R88 | 1823926 | 13 |
| SH-8EPS48A9LB1S | 1621558 | 63 | SPT-SMD 1,5/ 7-V-3,81 R44 | 1824242 | 7 | SPT-THR 1,5/ 4-H-5,0 P26 | 1822998 | 12 | SPT-THR 1,5/ 9-H-5,0 P26 | 1823049 | 12 |
| SH-8EPS48A9LB2S | 1621557 | 63 | SPT-SMD 1,5/ 7-V-5,0 R88 | 1824352 | 9 | SPT-THR 1,5/ 4-H-5,08 P20 R32 | 1823984 | 13 | SPT-THR 1,5/ 9-H-5,08 P20 R88 | 1824035 | 13 |
| SH-8EPS48A9LB3S | 1621556 | 63 | SPT-SMD 1,5/ 7-V-5,08 R88 | 1824462 | 9 | SPT-THR 1,5/ 4-H-5,08 P26 | 1823104 | 12 | SPT-THR 1,5/ 9-H-5,08 P26 | 1823159 | 12 |
| SH-8EPS48A9LB4S | 1621555 | 63 | SPT-SMD 1,5/ 8-H-3,5 R72 | 1824585 | 7 | SPT-THR 1,5/ 4-V-3,5 P20 R44 | 1823214 | 11 | SPT-THR 1,5/ 9-V-3,5 P20 R72 | 1823269 | 11 |
| SH-8EPS48A9LDLS | 1621554 | 63 | SPT-SMD 1,5/ 8-H-3,81 R72 | 1824695 | 7 | SPT-THR 1,5/ 4-V-3,5 P26 | 1822338 | 11 | SPT-THR 1,5/ 9-V-3,5 P26 | 1822383 | 11 |
| SH-8EPS48AAC00S | 1621562 | 65 | SPT-SMD 1,5/ 8-H-5,0 R88 | 1824802 | 9 | SPT-THR 1,5/ 4-V-3,81 P20 R44 | 1823324 | 11 | SPT-THR 1,5/ 9-V-3,81 P20 R72 | 1823379 | 11 |
| SH-8EPS48AAD00S | 1621566 | 65 | SPT-SMD 1,5/ 8-H-5,08 R88 | 1824912 | 9 | SPT-THR 1,5/ 4-V-3,81 P26 | 1822448 | 11 | SPT-THR 1,5/ 9-V-3,81 P26 | 1822493 | 11 |
| SH-8EPS48AWA00S | 1621570 | 64 | SPT-SMD 1,5/ 8-V-3,5 R72 | 1824145 | 7 | SPT-THR 1,5/ 4-V-5,0 P20 R56 | 1823434 | 13 | SPT-THR 1,5/ 9-V-5,0 P20 R88 | 1823489 | 13 |
| SH-8ESC58A8LB1S | 1621523 | 62 | SPT-SMD 1,5/ 8-V-3,81 R72 | 1824255 | 7 | SPT-THR 1,5/ 4-V-5,0 P26 | 1822558 | 13 | SPT-THR 1,5/ 9-V-5,0 P26 | 1822600 | 13 |
| SH-8ESC58A8LB2S | 1621522 | 62 | SPT-SMD 1,5/ 8-V-5,0 R88 | 1824365 | 9 | SPT-THR 1,5/ 4-V-5,08 P20 R56 | 1823544 | 13 | SPT-THR 1,5/ 9-V-5,08 P20 R88 | 1823599 | 13 |
| SH-8ESC58A8LB3S | 1621521 | 62 | SPT-SMD 1,5/ 8-V-5,08 R88 | 1824475 | 9 | SPT-THR 1,5/ 4-V-5,08 P26 | 1822668 | 13 | SPT-THR 1,5/ 9-V-5,08 P26 | 1822710 | 13 |
| SH-8ESC58A8LB4S | 1621520 | 62 | SPT-SMD 1,5/ 9-H-3,5 R72 | 1824598 | 7 | SPT-THR 1,5/ 5-H-3,5 P20 R32 | 1823667 | 11 | SPT-THR 1,5/ 10-H-3,5 P20 R72 | 1823719 | 11 |
| SH-8ESC58A8LDLS | 1621517 | 62 | SPT-SMD 1,5/ 9-H-3,81 R72 | 1824705 | 7 | SPT-THR 1,5/ 5-H-3,5 P26 | 1822781 | 10 | SPT-THR 1,5/ 10-H-3,5 P26 | 1822833 | 10 |
| SH-8ESC58A9LB1S | 1621543 | 63 | SPT-SMD 1,5/ 9-H-5,0 R88 | 1824815 | 9 | SPT-THR 1,5/ 5-H-3,81 P20 R32 | 1823777 | 11 | SPT-THR 1,5/ 10-H-3,81 P20 R72 | 1823829 | 11 |
| SH-8ESC58A9LB2S | 1621542 | 63 | SPT-SMD 1,5/ 9-H-5,08 R88 | 1824925 | 9 | SPT-THR 1,5/ 5-H-3,81 P26 | 1822891 | 10 | SPT-THR 1,5/ 10-H-3,81 P26 | 1822943 | 10 |
| SH-8ESC58A9LB3S | 1621541 | 63 | SPT-SMD 1,5/ 9-V-3,5 R72 | 1824158 | 7 | SPT-THR 1,5/ 5-H-5,0 P20 R56 | 1823887 | 13 | SPT-THR 1,5/ 10-H-5,0 P20 R88 | 1823939 | 13 |
| SH-8ESC58A9LB4S | 1621540 | 63 | SPT-SMD 1,5/ 9-V-3,81 R72 | 1824268 | 7 | SPT-THR 1,5/ 5-H-5,0 P26 | 1823007 | 12 | SPT-THR 1,5/ 10-H-5,0 P26 | 1823052 | 12 |
| SH-8ESC58A9LDLS | 1621539 | 63 | SPT-SMD 1,5/ 9-V-5,0 R88 | 1824378 | 9 | SPT-THR 1,5/ 5-H-5,08 P20 R56 | 1823997 | 13 | SPT-THR 1,5/ 10-H-5,08 P20 R88 | 1824048 | 13 |
| SH-8ESC58AAC00S | 1621559 | 65 | SPT-SMD 1,5/ 9-V-5,08 R88 | 1824488 | 9 | SPT-THR 1,5/ 5-H-5,08 P26 | 1823117 | 12 | SPT-THR 1,5/ 10-H-5,08 P26 | 1823162 | 12 |
| SH-8ESC58AAD00S | 1621563 | 65 | SPT-SMD 1,5/ 10-H-3,5 R72 | 1824608 | 7 | SPT-THR 1,5/ 5-V-3,5 P20 R44 | 1823227 | 11 | SPT-THR 1,5/ 10-V-3,5 P20 R72 | 1823272 | 11 |
| SH-8ESC58AWA00S | 1621567 | 64 | SPT-SMD 1,5/ 10-H-3,81 R72 | 1824718 | 7 | SPT-THR 1,5/ 5-V-3,5 P26 | 1822341 | 11 | SPT-THR 1,5/ 10-V-3,5 P26 | 1822396 | 11 |
| SH-8ESS48A8LB1S | 1621528 | 62 | SPT-SMD 1,5/ 10-H-5,0 R88 | 1824828 | 9 | SPT-THR 1,5/ 5-V-3,81 P20 R44 | 1823337 | 11 | SPT-THR 1,5/ 10-V-3,81 P20 R72 | 1823382 | 11 |
| SH-8ESS48A8LB2S | 1621527 | 62 | SPT-SMD 1,5/ 10-H-5,08 R88 | 1824938 | 9 | SPT-THR 1,5/ 5-V-3,81 P26 | 1822451 | 11 | SPT-THR 1,5/ 10-V-3,81 P26 | 1822503 | 11 |
| SH-8ESS48A8LB3S | 1621526 | 62 | SPT-SMD 1,5/ 10-V-3,5 R72 | 1824161 | 7 | SPT-THR 1,5/ 5-V-5,0 P20 R56 | 1823447 | 13 | SPT-THR 1,5/ 10-V-5,0 P20 R88 | 1823492 | 13 |
| SH-8ESS48A8LB4S | 1621525 | 62 | SPT-SMD 1,5/ 10-V-3,81 R72 | 1824271 | 7 | SPT-THR 1,5/ 5-V-5,0 P26 | 1822561 | 13 | SPT-THR 1,5/ 10-V-5,0 P26 | 1822613 | 13 |
| SH-8ESS48A8LDLS | 1621524 | 62 | SPT-SMD 1,5/ 10-V-5,0 R88 | 1824381 | 9 | SPT-THR 1,5/ 5-V-5,08 P20 R56 | 1823557 | 13 | SPT-THR 1,5/ 10-V-5,08 P20 R88 | 1823609 | 13 |
| SH-8ESS48A9LB1S | 1621548 | 63 | SPT-SMD 1,5/ 10-V-5,08 R88 | 1824491 | 9 | SPT-THR 1,5/ 5-V-5,08 P26 | 1822671 | 13 | SPT-THR 1,5/ 10-V-5,08 P26 | 1822723 | 13 |
| SH-8ESS48A9LB2S | 1621547 | 63 | SPT-SMD 1,5/ 11-H-3,5 R72 | 1824611 | 7 | SPT-THR 1,5/ 6-H-3,5 P20 R44 | 1823670 | 11 | SPT-THR 1,5/ 11-H-3,5 P20 R72 | 1823722 | 11 |
| SH-8ESS48A9LB3S | 1621546 | 63 | SPT-SMD 1,5/ 11-H-3,81 R72 | 1824721 | 7 | SPT-THR 1,5/ 6-H-3,5 P26 | 1822794 | 10 | SPT-THR 1,5/ 11-H-3,5 P26 | 1822846 | 10 |
| SH-8ESS48A9LB4S | 1621545 | 63 | SPT-SMD 1,5/ 11-H-5,0 R88 | 1824831 | 9 | SPT-THR 1,5/ 6-H-3,81 P20 R44 | 1823780 | 11 | SPT-THR 1,5/ 11-H-3,81 P20 R72 | 1823832 | 11 |
| SH-8ESS48A9LDLS | 1621544 | 63 | SPT-SMD 1,5/ 11-H-5,08 R88 | 1824941 | 9 | SPT-THR 1,5/ 6-H-3,81 P26 | 1822901 | 10 | SPT-THR 1,5/ 11-H-3,81 P26 | 1822956 | 10 |
| SH-8ESS48AAC00S | 1621560 | 65 | SPT-SMD 1,5/ 11-V-3,5 R72 | 1824174 | 7 | SPT-THR 1,5/ 6-H-5,0 P20 R56 | 1823890 | 13 | SPT-THR 1,5/ 11-H-5,0 P20 R88 | 1823942 | 13 |
| SH-8ESS48AAD00S | 1621564 | 65 | SPT-SMD 1,5/ 11-V-3,81 R72 | 1824284 | 7 | SPT-THR 1,5/ 6-H-5,0 P26 | 1823010 | 12 | SPT-THR 1,5/ 11-H-5,0 P26 | 1823065 | 12 |
| SH-8ESS48AWA00S | 1621568 | 64 | SPT-SMD 1,5/ 11-V-5,0 R88 | 1824394 | 9 | SPT-THR 1,5/ 6-H-5,08 P20 R56 | 1824006 | 13 | SPT-THR 1,5/ 11-H-5,08 P20 R88 | 1824051 | 13 |
| SK 5,0 WH:REEL | 0805221 | 339 | SPT-SMD 1,5/ 11-V-5,08 R88 | 1824501 | 9 | SPT-THR 1,5/ 6-H-5,08 P26 | 1823120 | 12 | SPT-THR 1,5/ 11-H-5,08 P26 | 1823175 | 12 |
| SPT-SMD 1,5/ 2-H-3,5 R24 | 1824527 | 7 | SPT-SMD 1,5/ 12-H-3,5 R72 | 1824624 | 7 | SPT-THR 1,5/ 6-V-3,5 P20 R44 | 1823230 | 11 | SPT-THR 1,5/ 11-V-3,5 P20 R72 | 1823285 | 11 |
| SPT-SMD 1,5/ 2-H-3,81 R24 | 1824637 | 7 | SPT-SMD 1,5/ 12-H-5,0 R88 | 1824734 | 7 | SPT-THR 1,5/ 6-V-3,5 P26 | 1822354 | 11 | SPT-THR 1,5/ 11-V-3,5 P26 | 1822406 | 11 |
| SPT-SMD 1,5/ 2-H-5,0 R24 | 1824747 | 9 | SPT-SMD 1,5/ 12-H-5,08 R88 | 1824844 | 9 | SPT-THR 1,5/ 6-V-3,81 P20 R44 | 1823340 | 11 | SPT-THR 1,5/ 11-V-3,81 P20 R72 | 1823395 | 11 |
| SPT-SMD 1,5/ 2-H-5,08 R24 | 1824857 | 9 | SPT-SMD 1,5/ 12-H-5,08 R88 | 1824954 | 9 | SPT-THR 1,5/ 6-V-3,81 P26 | 1822464 | 11 | SPT-THR 1,5/ 11-V-3,81 P26 | 1822516 | 11 |
| SPT-SMD 1,5/ 2-V-3,5 R24 | 1824080 | 7 | SPT-SMD 1,5/ 12-V-3,5 R72 | 1824187 | 7 | SPT-THR 1,5/ 6-V-5,0 P20 R56 | 1823450 | 13 | SPT-THR 1,5/ 11-V-5,0 P20 R88 | 1823502 | 13 |
| SPT-SMD 1,5/ 2-V-3,81 R24 | 1824190 | 7 | SPT-SMD 1,5/ 12-V-3,81 R72 | 1824297 | 7 | SPT-THR 1,5/ 6-V-5,0 P26 | 1822574 | 13 | SPT-THR 1,5/ 11-V-5,0 P26 | 1822626 | 13 |
| SPT-SMD 1,5/ 2-V-5,0 R24 | 1824307 | 9 | SPT-SMD 1,5/ 12-V-5,0 R88 | 1824404 | 9 | SPT-THR 1,5/ 6-V-5,08 P20 R56 | 1823560 | 13 | SPT-THR 1,5/ 11-V-5,08 P20 R88 | 1823612 | 13 |
| SPT-SMD 1,5/ 2-V-5,08 R24 | 1824417 | 9 | SPT-SMD 1,5/ 12-V-5,08 R88 | 1824514 | 9 | SPT-THR 1,5/ 6-V-5,08 P26 | 1822684 | 13 | SPT-THR 1,5/ 11-V-5,08 P26 | 1822736 | 13 |
| SPT-SMD 1,5/ 3-H-3,5 R24 | 1824530 | 7 | SPT-THR 1,5/ 2-H-3,5 P20 R24 | 1823638 | 11 | SPT-THR 1,5/ 7-H-3,5 P20 R44 | 1823683 | 11 | SPT-THR 1,5/ 12-H-3,5 P20 R72 | 1823735 | 11 |
| SPT-SMD 1,5/ 3-H-3,81 R24 | 1824640 | 7 | SPT-THR 1,5/ 2-H-3,5 P26 | 1822752 | 10 | SPT-THR 1,5/ 7-H-3,5 P26 | 1822804 | 10 | SPT-THR 1,5/ 12-H-3,5 P26 | 1822859 | 10 |
| SPT-SMD 1,5/ 3-H-5,0 R32 | 1824750 | 9 | SPT-THR 1,5/ 2-H-3,81 P20 R24 | 1823748 | 11 | SPT-THR 1,5/ 7-H-3,81 P20 R44 | 1823793 | 11 | SPT-THR 1,5/ 12-H-3,81 P20 R72 | 1823845 | 11 |
| SPT-SMD 1,5/ 3-H-5,08 R32 | 1824860 | 9 | SPT-THR 1,5/ 2-H-3,81 P26 | 1822862 | 10 | SPT-THR 1,5/ 7-H-3,81 P26 | 1822914 | 10 | SPT-THR 1,5/ 12-H-3,81 P26 | 1822969 | 10 |
| SPT-SMD 1,5/ 3-V-3,5 R32 | 1824093 | 7 | SPT-THR 1,5/ 2-H-5,0 P20 R24 | 1823858 | 13 | SPT-THR 1,5/ 7-H-5,0 P20 R56 | 1823900 | 13 | SPT-THR 1,5/ 12-H-5,0 P20 R88 | 1823955 | 13 |
| SPT-SMD 1,5/ 3-V-3,81 R32 | 1824200 | 7 | SPT-THR 1,5/ 2-H-5,0 P26 | 1822972 | 12 | SPT-THR 1,5/ 7-H-5,0 P26 | 1823023 | 12 | SPT-THR 1,5/ 12-H-5,0 P26 | 1823078 | 12 |
| SPT-SMD 1,5/ 3-V-5,0 R32 | 1824310 | 9 | SPT-THR 1,5/ 2-H-5,08 P20 R24 | 1823968 | 13 | SPT-THR 1,5/ 7-H-5,08 P20 R56 | 1824019 | 13 | SPT-THR 1,5/ 12-H-5,08 P20 R88 | 1824064 | 13 |
| SPT-SMD 1,5/ 3-V-5,08 R32 | 1824420 | 9 | SPT-THR 1,5/ 2-H-5,08 P26 | 1823081 | 12 | SPT-THR 1,5/ 7-H-5,08 P26 | 1823133 | 12 | SPT-THR 1,5/ 12-H-5,08 P26 | 1823188 | 12 |
| SPT-SMD 1,5/ 4-H-3,5 R44 | 1824543 | 7 | SPT-THR 1,5/ 2-V-3,5 P20 R24 | 1823191 | 11 | SPT-THR 1,5/ 7-V-3,5 P20 R44 | 1823243 | 11 | SPT-THR 1,5/ 12-V-3,5 P20 R72 | 1823298 | 11 |
| SPT-SMD 1,5/ 4-H-3,81 R44 | 1824653 | 7 | SPT-THR 1,5/ 2-V-3,5 P26 | 1822312 | 11 | SPT-THR 1,5/ 7-V-3,5 P26 | 1822367 | 11 | SPT-THR 1,5/ 12-V-3,5 P26 | 1822419 | 11 |
| SPT-SMD 1,5/ 4-H-5,0 R44 | 1824763 | 9 | SPT-THR 1,5/ 2-V-3,81 P20 R24 | 1823308 | 11 | SPT-THR 1,5/ 7-V-3,81 P20 R44 | 1823353 | 11 | SPT-THR 1,5/ 12-V-3,81 P20 R72 | 1823405 | 11 |
| SPT-SMD 1,5/ 4-H-5,08 R44 | 1824873 | 9 | SPT-THR 1,5/ 2-V-3,81 P26 | 1822422 | 11 | SPT-THR 1,5/ 7-V-3,81 P26 | 1822477 | 11 | SPT-THR 1,5/ 12-V-3,81 P26 | 1822529 | 11 |
| SPT-SMD 1,5/ 4-V-3,5 R44 | 1824103 | 7 | SPT-THR 1,5/ 2-V-5,0 P20 R24 | 1823418 | 13 | SPT-THR 1,5/ 7-V-5,0 P20 R56 | 1823463 | 13 | SPT-THR 1,5/ 12-V-5,0 P20 R88 | 1823515 | 13 |
| SPT-SMD 1,5/ 4-V-3,81 R44 | 1824213 | 7 | SPT-THR 1,5/ 2-V-5,0 P26 | 1822532 | 13 | SPT-THR 1,5/ 7-V-5,0 P26 | 1822587 | 13 | SPT-THR 1,5/ 12-V-5,0 P26 | 1822639 | 13 |
| SPT-SMD 1 | | | | | | | | | | | |

| Type | Order No. | Page | Type | Order No. | Page | Type | Order No. | Page | Type | Order No. | Page |
|-------------------------------|-----------|------|-----------------------------|-----------|------|-----------------------------|-----------|------|----------------------------|-----------|------|
| SPTA 5/5-7,5-ZB | 1819118 | 25 | TMT (EX5,5)R CUS | 0803072 | 266 | UCT-WMCO 3,5 (18X4) | 0830783 | 269 | UT 6-TG P/P-EX | 3073870 | 163 |
| SPTA 5/6-7,5-ZB | 1819121 | 25 | TMT (EX6,2)R | 0803063 | 266 | UCT-WMCO 3,5 (18X4) CUS | 0830791 | 269 | UT 6-TG-EX | 3046486 | 163 |
| SPTA 5/7-7,5-ZB | 1819134 | 25 | TMT (EX6,2)R CUS | 0803073 | 266 | UCT-WMCO 4,1 (12X4) | 0830784 | 269 | UTRE 6-2/10 | 3069811 | 95 |
| SPTA 5/8-7,5-ZB | 1819147 | 25 | TMT (EX6,5)R | 0803064 | 266 | UCT-WMCO 4,1 (12X4) CUS | 0830792 | 269 | UTRE 6-2/12 | 3069813 | 95 |
| SPTA 5/9-7,5-ZB | 1819150 | 25 | TMT (EX6,5)R CUS | 0803075 | 266 | UCT-WMCO 4,1 (18X4) | 0830785 | 269 | UTRE 6-2/14 | 3069815 | 95 |
| SPTA 5/10-7,5-ZB | 1819163 | 25 | TMT (EX7,5)R | 0803065 | 266 | UCT-WMCO 4,1 (18X4) CUS | 0830793 | 269 | UTRE 6-2/15 | 3069816 | 95 |
| SPTA 5/11-7,5-ZB | 1819176 | 25 | TMT (EX7,5)R CUS | 0803076 | 266 | UCT-WMCO 4,7 (12X4) | 0830786 | 269 | UTRE 6-2/17 | 3069818 | 95 |
| SPTA 5/12-7,5-ZB | 1819189 | 25 | TMT (EX8)R | 0803066 | 266 | UCT-WMCO 4,7 (12X4) CUS | 0830794 | 269 | UTRE 6-2/19 | 3069820 | 95 |
| SPTD 1,5/2-H-3,5 | 1841490 | 15 | TMT (EX8)R CUS | 0803077 | 266 | UCT-WMCO 4,7 (18X4) | 0830787 | 269 | UTRE 6-2/20 | 3069821 | 95 |
| SPTD 1,5/3-H-3,5 | 1841500 | 15 | TMT (EX8,5)R | 0803067 | 266 | UCT-WMCO 4,7 (18X4) CUS | 0830795 | 269 | UTRE 6-2/21 | 3069822 | 95 |
| SPTD 1,5/4-H-3,5 | 1841513 | 15 | TMT (EX8,5)R CUS | 0803078 | 266 | UCT-WMTBA (24X4) | 1014082 | 270 | UTRE 6-2/22 | 3069823 | 95 |
| SPTD 1,5/5-H-3,5 | 1841526 | 15 | TMT (EX9,5)R | 0828295 | 266 | UCT-WMTBA (24X4) CUS | 1014088 | 270 | UTRE 6-2/25 | 3069826 | 95 |
| SPTD 1,5/6-H-3,5 | 1841539 | 15 | TMT (EX9,5)R CUS | 0803079 | 266 | UCT-WMTBA (24X4) YE | 1014083 | 270 | UTRE 6-2/4 | 3069805 | 95 |
| SPTD 1,5/7-H-3,5 | 1841542 | 15 | TMT TOOL | 0816650 | 266 | UCT-WMTBA (24X6) YE CUS | 1014089 | 270 | UTRE 6-2/5 | 3069806 | 95 |
| SPTD 1,5/8-H-3,5 | 1841555 | 15 | TMT2 (EX11)R | 0802683 | 266 | UCT-WMTBA (29X6) | 1014084 | 271 | UTRE 6-2/9 | 3069810 | 95 |
| SPTD 1,5/9-H-3,5 | 1841568 | 15 | TMT2 (EX11)R CUS | 0830811 | 266 | UCT-WMTBA (29X6) CUS | 1014090 | 271 | UTRE 6-2/A14 | 3069426 | 135 |
| SPTD 1,5/10-H-3,5 | 1841571 | 15 | TOOL-BAG CUS | 1200081 | 296 | UCT-WMTBA (29X6) YE | 1014085 | 271 | UTRE 6-2/A7 | 3069423 | 129 |
| SPTD 1,5/11-H-3,5 | 1841584 | 15 | TOOL-BELTPOUCH CUS | 1200084 | 297 | UCT-WMTBA (29X6) YE CUS | 1014091 | 271 | UTRE 6-2/B14 | 3069427 | 137 |
| SPTD 1,5/12-H-3,5 | 1841597 | 15 | TOOL-CARRIER CUS | 1200082 | 296 | UCT-WMTBA (40X17) | 1014086 | 271 | UTRE 6-2/B19 | 3069429 | 141 |
| ST-10KP010 | 1618255 | 66 | TOOL-CASE | 1212629 | 296 | UCT-WMTBA (40X17) CUS | 1014092 | 271 | UTRE 6-2/B7 | 3069424 | 131 |
| ST-10KP020 | 1618256 | 66 | TOOL-CASE CUS | 1200072 | 296 | UCT-WMTBA (40X17) YE | 1014087 | 271 | UTRE 6-2/C14 | 3069428 | 139 |
| ST-10KP030 | 1618261 | 66 | TOOL-KIT CUS | 1200085 | 297 | UCT-WMTBA (40X17) YE CUS | 1014093 | 271 | UTRE 6-2/C19 | 3069430 | 143 |
| ST-10KS010 | 1618239 | 66 | TOOL-WRAP CUS | 1200083 | 297 | UK 4-SD | 3246861 | 170 | UTRE 6-2/D19 | 3069431 | 145 |
| ST-10KS020 | 1618251 | 66 | TOPMARK LASER | 0831831 | 245 | UM1-TM (12X10) | 0830916 | 264 | UTRE 6-2/E7 | 3069425 | 133 |
| ST-10KS030 | 1618254 | 66 | TOPMARK LASER STATION | 0831835 | 245 | UM1-TM (3,5X12) | 0830925 | 264 | UTRE 6-2/F19 | 3069432 | 147 |
| STEP-PS/1AC/24DC/0,75 | 2868635 | 394 | TOPMARK LASER-MAG CARD | 0831837 | 245 | UM1-TM (5X10) | 0830905 | 264 | UTRE 6-2/G19 | 3069433 | 149 |
| STP 5-2-ZB | 3037643 | 173 | TOPMARK LASER-MAG SHEET | 0831836 | 245 | UM1-TM (5X12) | 0830912 | 264 | UTRE 6-2/H19 | 3069434 | 151 |
| SUBCON 9/F-SH | 2761499 | 391 | TOUCH PEN | 2701379 | 418 | UM1-TM (6X10) | 0830903 | 264 | UTRE 6-2/I19 | 3069435 | 153 |
| SUBCON-PLUS-CAN/35/M12 | 2902325 | 397 | TP 07T/M 211 | 2701452 | 418 | UM1-TM (6X12) | 0830909 | 264 | UTT 2,5-2MT-P/P | 3044670 | 165 |
| SUBCON-PLUS-CAN/35/PG/M12 | 2902324 | 397 | TP 10T/M 211 | 2701843 | 419 | UM1-TM (8X10) | 0830906 | 264 | UTT 2,5-2MT-P/P BU | 3044671 | 165 |
| SUBCON-PLUS-CAN/90/M12 | 2902323 | 397 | TP 12T/M 211 | 2701844 | 419 | UM1-TM (8X12) | 0830920 | 264 | UTTB 2,5-MT-P/P | 3044640 | 165 |
| SUBCON-PLUS-CAN/90/PG/M12 | 2902322 | 397 | TP 15T/M 211 | 2701845 | 419 | UM1-TMF (3,5X5) | 0830935 | 265 | UTTB 2,5-MT-P/P BU | 3044641 | 165 |
| SUBCON-PLUS-CAN/90X/M12 | 2902731 | 396 | | | | UM1-TMF (5X5) | 0830902 | 265 | UTTB 2,5-TG-P/P | 3044644 | 164 |
| SUBCON-PLUS-CAN/90X/PG/M12 | 2902730 | 396 | | | | UM1-TMF (6X5) | 0830904 | 265 | UTWE 6-2/10 | 3069658 | 94 |
| SUBCON-PLUS-M/AX 9 | 2904467 | 431 | | | | UM1-TMF (8X5) | 0830924 | 265 | UTWE 6-2/12 | 3069660 | 94 |
| SUBCON-PLUS-PROFIB/35/M12 | 2902320 | 397 | | | | UM1U-TM (5X10) | 0830910 | 265 | UTWE 6-2/14 | 3069663 | 94 |
| SUBCON-PLUS-PROFIB/35/PG/M12 | 2902319 | 397 | UC-EMLP (15X5) | 0819301 | 339 | UM1U-TM (6X10) | 0830907 | 265 | UTWE 6-2/15 | 3069664 | 94 |
| SUBCON-PLUS-PROFIB/90/M12 | 2902318 | 397 | UC-EMLP (15X5) CUS | 0824550 | 339 | UNO-PS/1AC/5DC/25W | 2904374 | 316 | UTWE 6-2/17 | 3069667 | 94 |
| SUBCON-PLUS-PROFIB/90/PG/M12 | 2902317 | 397 | UC-EMLP (22X22)-EX | 0803224 | 276 | UNO-PS/1AC/5DC/40W | 2904375 | 316 | UTWE 6-2/19 | 3069672 | 94 |
| SUBCON-PLUS-PROFIB/90X/M12 | 2902729 | 396 | UC-EMLP (22X22)-EX CUS | 0803229 | 276 | UNO-PS/1AC/12DC/100W | 2902997 | 317 | UTWE 6-2/20 | 3069673 | 94 |
| SUBCON-PLUS-PROFIB/90X/PG/M12 | 2902728 | 396 | UC-EMLP (27X18)-EX | 0803225 | 276 | UNO-PS/1AC/15DC/55W | 2903001 | 317 | UTWE 6-2/21 | 3069800 | 94 |
| SZF 0-0,4X2,5 | 1204504 | 156 | UC-EMLP (27X18)-EX CUS | 0803230 | 276 | UNO-PS/1AC/15DC/100W | 2903002 | 317 | UTWE 6-2/22 | 3069801 | 94 |
| SZF 1-0,6X3,5 | 1204517 | 158 | UC-EMLP (27X27)-EX | 0803226 | 276 | UNO-PS/1AC/15DC/30W | 2903000 | 317 | UTWE 6-2/25 | 3069804 | 94 |
| SZG 0,6X3,5 VDE | 1205121 | 164 | UC-EMLP (27X27)-EX CUS | 0803231 | 276 | UNO-PS/1AC/24DC/90W/C2LPS | 2902994 | 318 | UTWE 6-2/4 | 3069650 | 94 |
| SZS 0,6X3,5 | 1205053 | 162 | UC-EMLP (49X15)-EX | 0803227 | 276 | UNO-PS/1AC/48DC/60W | 2902995 | 319 | UTWE 6-2/5 | 3069651 | 94 |
| SZS 1,0X4,0 VDE | 1205066 | 163 | UC-EMLP (49X15)-EX CUS | 0803232 | 276 | UNO-PS/1AC/48DC/100W | 2902996 | 319 | UTWE 6-2/9 | 3069656 | 94 |
| | | | UC-EMLP (60X30)-EX | 0803228 | 276 | UNO-PS/2AC/24DC/90W/C2LPS | 2904371 | 319 | UTWE 6-2/A14 | 3069413 | 134 |
| | | | UC-EMLP (60X30)-EX CUS | 0803233 | 276 | US-EMLP-HA (17X7) | 0830988 | 278 | UTWE 6-2/A7 | 3069410 | 128 |
| | | | UC-TMF 5 | 0818153 | 44 | US-EMLP-HA (17X7) CUS | 0830994 | 278 | UTWE 6-2/B14 | 3069414 | 136 |
| | | | UCT-EM (30X5) | 0801505 | 339 | US-EMLP-HA (20X9) | 0830989 | 278 | UTWE 6-2/B19 | 3069416 | 140 |
| | | | UCT-EM (30X5) CUS | 0801589 | 339 | US-EMLP-HA (20X9) CUS | 0830995 | 278 | UTWE 6-2/B7 | 3069411 | 130 |
| | | | UCT-EMP (25X6) | 1014117 | 272 | US-EMLP-HA (60X30) | 0830990 | 278 | UTWE 6-2/C14 | 3069415 | 138 |
| | | | UCT-EMP (25X6) CUS | 1014121 | 272 | US-EMLP-HA (60X30) CUS | 0830996 | 278 | UTWE 6-2/C19 | 3069417 | 142 |
| | | | UCT-EMP (29X8) | 1014118 | 273 | US-EMLP-HA (60X30) SR | 0830991 | 278 | UTWE 6-2/D19 | 3069418 | 144 |
| | | | UCT-EMP (29X8) CUS | 1014122 | 273 | US-EMLP-HA (60X30) SR CUS | 0830997 | 278 | UTWE 6-2/E7 | 3069412 | 132 |
| | | | UCT-EMP (40X17) | 1014120 | 273 | US-EMLP-HA (85,6X54) | 0830992 | 278 | UTWE 6-2/F19 | 3069419 | 146 |
| | | | UCT-EMP (40X17) CUS | 1014124 | 273 | US-EMLP-HA (85,6X54) CUS | 0830998 | 278 | UTWE 6-2/G19 | 3069420 | 148 |
| | | | UCT-EMP (60X15) | 1014119 | 273 | US-EMLP-HA (85,6X54) SR | 0830993 | 278 | UTWE 6-2/H19 | 3069421 | 150 |
| | | | UCT-EMP (60X15) CUS | 1014123 | 273 | US-EMLP-HA (85,6X54) SR CUS | 0830999 | 278 | UTWE 6-2/I19 | 3069422 | 152 |
| | | | UCT-PMLP (90X38) | 0803041 | 286 | US-EMP (25X6)-1 | 0802754 | 272 | | | |
| | | | UCT-PMLP (90X38) CUS | 0803042 | 286 | US-EMP (29X8) | 0829436 | 273 | | | |
| | | | UCT-PMLP-RFID/HF (90X38) | 0830956 | 282 | US-EMP (40X17) | 0829437 | 273 | | | |
| | | | UCT-PMLP-RFID/UHF (90X38) | 0830957 | 283 | US-EMP (60X15) | 0828781 | 273 | | | |
| | | | UCT-PMP (90X38) | 0803039 | 287 | USA 10/4,6 | 1202713 | 195 | | | |
| | | | UCT-PMP (90X38) BU | 0803047 | 287 | UT 4-L | 3214363 | 166 | VAL-MS 350 VF ST | 2856595 | 306 |
| | | | UCT-PMP (90X38) BU CUS | 8190566 | 287 | UT 4-L/HESI (5X20) | 3214325 | 168 | VAL-MS 75 VF ST | 2805318 | 306 |
| | | | UCT-PMP (90X38) CUS | 0803040 | 287 | UT 4-L/L | 3214362 | 166 | VAL-MS BE-AR | 2801065 | 306 |
| | | | UCT-PMP (90X38) VT | 0803132 | 287 | UT 4-MT-EX | 3046141 | 163 | VAL-MS BE-AR/FM | 2801066 | 306 |
| | | | UCT-PMP (90X38) VT CUS | 8190707 | 287 | UT 4-MT-P/P-EX | 3046173 | 163 | VAL-MS-AR 350 VF | 2801489 | 306 |
| | | | UCT-PMP (90X38) YE | 0803133 | 287 | UT 4-PE/L/HEDI | 3214324 | 169 | VAL-MS-AR 350 VF/FM | 2801490 | 306 |
| | | | UCT-PMP (90X38) YE CUS | 8190708 | 287 | UT 4-PE/L/HESI (5X20) | 3214320 | 169 | VAL-MS-AR 75 VF | 2801487 | 306 |
| | | | UCT-PMP-RFID/HF (90X38) | 0830954 | 284 | UT 4-PE/L/HESI (5X20) | 3214321 | 169 | VAL-MS-AR 75 VF/FM | 2801488 | 306 |
| | | | UCT-PMP-RFID/HF (90X38) CUS | 0830955 | 285 | UT 4-PE/L/HESI (5X20) | 3214323 | 169 | VAL-MS-AR-T1/T2 75 | 2801491 | 306 |
| | | | UCT-PMP-RFID/UHF (90X38) | 0830348 | 285 | UT 4-PE/L/HESI (5X20) | 3214322 | 169 | VAL-MS-AR-T1/T2 75/FM | 2801492 | 306 |
| | | | UCT-WMCO 2,9 (12X4) | 0830780 | 268 | UT 4-PE/L/L | 3214360 | 167 | VAL-MS-T1/T2 48/12,5 ST | 2801242 | 307 |
| | | | UCT-WMCO 2,9 (12X4) CUS | 0830788 | 268 | UT 4-PE/L/MT | 3214364 | 167 | VAL-MS-T1/T2 48/12,5+1V | 2801532 | 307 |
| | | | UCT-WMCO 2,9 (18X4) | 0830781 | 268 | UT 4-PE/L/N | 3214361 | 167 | VAL-MS-T1/T2 48/12,5+1V-FM | 2801533 | 307 |
| | | | UCT-WMCO 2,9 (18X4) CUS | 0830789 | 268 | UT 4-PE/L/TG | 3214365 | 167 | VAL-MS-T1/T2 75/12,5 ST | 2801146 | 306 |
| | | | UCT-WMCO 3,5 (12X4) | 0830782 | 269 | UT 4-TG-EX | 3046143 | 162 | VAL-SQ NP 120-2-A 32 | 2800371 | 309 |
| | | | UCT-WMCO 3,5 (12X4) CUS | 0830790 | 269 | UT 4-TG-P/P-EX | 3046169 | 162 | VAL-SQ NP 120-2-A 32 ST | 2800369 | 309 |

T

U

V

Index

Alphabetical

| Type | Order No. | Page | Type | Order No. | Page | Type | Order No. | Page |
|-------------------------------|-----------|------|------|-----------|------|------|-----------|------|
| VAL-SQ NP 120-2-A BE | 2800749 | 309 | | | | | | |
| VIP-2/PT/PDM-2/16/FU 6.3A | 2903603 | 373 | | | | | | |
| VIP-8RPT-120AC/1AU/DI/PLC | 2904576 | 371 | | | | | | |
| VIP-8RPT-24DC/1AU/DI/PLC | 2903600 | 371 | | | | | | |
| VIP-8RPT-24DC/21/D0/FU/PLC | 2903601 | 370 | | | | | | |
| VIP-PA-PWR/20XOE/ 1,0M/S7 | 2904724 | 369 | | | | | | |
| VIP-PA-PWR/20XOE/ 2,0M/S7 | 2904725 | 369 | | | | | | |
| VIP-PA-PWR/20XOE/ 3,0M/S7 | 2904726 | 369 | | | | | | |
| VIP-PA-PWR/20XOE/ 4,0M/S7 | 2904727 | 369 | | | | | | |
| VIP-PA-PWR/20XOE/ 6,0M/S7 | 2904728 | 369 | | | | | | |
| VIP-PA-PWR/20XOE/ 8,0M/S7 | 2904729 | 369 | | | | | | |
| VIP-PA-PWR/20XOE/10,0M/S7 | 2904730 | 369 | | | | | | |
| VIP-PA-PWR/2X10COMBI/ 0,5M/S7 | 2904713 | 369 | | | | | | |
| VIP-PA-PWR/2X10COMBI/ 1,0M/S7 | 2904714 | 369 | | | | | | |
| VIP-PA-PWR/2X10COMBI/ 1,5M/S7 | 2904715 | 369 | | | | | | |
| VIP-PA-PWR/2X10COMBI/ 2,0M/S7 | 2904716 | 369 | | | | | | |
| VIP-PA-PWR/2X10COMBI/ 2,5M/S7 | 2904717 | 369 | | | | | | |
| VIP-PA-PWR/2X10COMBI/ 3,0M/S7 | 2904718 | 369 | | | | | | |
| VIP-PA-PWR/2X10COMBI/ 4,0M/S7 | 2904719 | 369 | | | | | | |
| VIP-PA-PWR/2X10COMBI/ 5,0M/S7 | 2904720 | 369 | | | | | | |
| VIP-PA-PWR/2X10COMBI/ 6,0M/S7 | 2904721 | 369 | | | | | | |
| VIP-PA-PWR/2X10COMBI/ 8,0M/S7 | 2904722 | 369 | | | | | | |
| VIP-PA-PWR/2X10COMBI/10,0M/S7 | 2904723 | 369 | | | | | | |
| VIP-PA-PWR/40XOE/ 1,0M/S7 | 2904731 | 369 | | | | | | |
| VIP-PA-PWR/40XOE/ 2,0M/S7 | 2904732 | 369 | | | | | | |
| VIP-PA-PWR/40XOE/ 3,0M/S7 | 2904733 | 369 | | | | | | |
| VIP-PA-PWR/40XOE/ 4,0M/S7 | 2904734 | 369 | | | | | | |
| VIP-PA-PWR/40XOE/ 6,0M/S7 | 2904735 | 369 | | | | | | |
| VIP-PA-PWR/40XOE/ 8,0M/S7 | 2904736 | 369 | | | | | | |
| VIP-PA-PWR/40XOE/10,0M/S7 | 2904737 | 369 | | | | | | |
| VIP-PA-PWR/4X10COMBI/ 0,5M/S7 | 2904702 | 368 | | | | | | |
| VIP-PA-PWR/4X10COMBI/ 1,0M/S7 | 2904703 | 368 | | | | | | |
| VIP-PA-PWR/4X10COMBI/ 1,5M/S7 | 2904704 | 368 | | | | | | |
| VIP-PA-PWR/4X10COMBI/ 2,0M/S7 | 2904705 | 368 | | | | | | |
| VIP-PA-PWR/4X10COMBI/ 2,5M/S7 | 2904706 | 368 | | | | | | |
| VIP-PA-PWR/4X10COMBI/ 3,0M/S7 | 2904707 | 368 | | | | | | |
| VIP-PA-PWR/4X10COMBI/ 4,0M/S7 | 2904708 | 368 | | | | | | |
| VIP-PA-PWR/4X10COMBI/ 5,0M/S7 | 2904709 | 368 | | | | | | |
| VIP-PA-PWR/4X10COMBI/ 6,0M/S7 | 2904710 | 368 | | | | | | |
| VIP-PA-PWR/4X10COMBI/ 8,0M/S7 | 2904711 | 368 | | | | | | |
| VIP-PA-PWR/4X10COMBI/10,0M/S7 | 2904712 | 368 | | | | | | |
| VIP-PT/FLK16/DS/FU/LED/AN/DV | 2903599 | 372 | | | | | | |
| VS-CABLE-STRIP-VARIO | 1657407 | 44 | | | | | | |

W

| | | |
|---------------------|---------|-----|
| WIREFOX 10 CUS | 1212760 | 301 |
| WIREFOX 16 CUS | 1212761 | 301 |
| WIREFOX 4 CUS | 1212762 | 301 |
| WIREFOX 6SC CUS | 1212763 | 301 |
| WT-HP HF 3,6X140 | 0830982 | 272 |
| WT-HP HF 4,5X290 | 0830984 | 272 |
| WT-HP HF 4,8X200 | 0830983 | 272 |
| WT-UV HF 3,6X140 BK | 3240832 | 274 |
| WT-UV HF 4,5X200 BK | 3240834 | 274 |
| WT-UV HF 4,5X290 BK | 3240835 | 274 |

| Type | Order No. | Page | Type | Order No. | Page | Type | Order No. | Page | Type | Order No. | Page |
|------|-----------|------|------|-----------|------|------|-----------|------|------|-----------|------|
|------|-----------|------|------|-----------|------|------|-----------|------|------|-----------|------|

EMC: Class A product:

In accordance with statutory regulations, our products are indicated with this footnote if they are intended for use in industrial environments. This means that the permissible limit values for residential applications may be exceeded in the event of conducted and emitted interference. In such cases, the operator may have to take additional safety measures in order to ensure electromagnetic compatibility in residential applications.





Компания «ЭлектроПласт» предлагает заключение долгосрочных отношений при поставках импортных электронных компонентов на взаимовыгодных условиях!

Наши преимущества:

- Оперативные поставки широкого спектра электронных компонентов отечественного и импортного производства напрямую от производителей и с крупнейших мировых складов;
- Поставка более 17-ти миллионов наименований электронных компонентов;
- Поставка сложных, дефицитных, либо снятых с производства позиций;
- Оперативные сроки поставки под заказ (от 5 рабочих дней);
- Экспресс доставка в любую точку России;
- Техническая поддержка проекта, помощь в подборе аналогов, поставка прототипов;
- Система менеджмента качества сертифицирована по Международному стандарту ISO 9001;
- Лицензия ФСБ на осуществление работ с использованием сведений, составляющих государственную тайну;
- Поставка специализированных компонентов (Xilinx, Altera, Analog Devices, Intersil, Interpoint, Microsemi, Aeroflex, Peregrine, Syfer, Eurofarad, Texas Instrument, Miteq, Cobham, E2V, MA-COM, Hittite, Mini-Circuits, General Dynamics и др.);

Помимо этого, одним из направлений компании «ЭлектроПласт» является направление «Источники питания». Мы предлагаем Вам помощь Конструкторского отдела:

- Подбор оптимального решения, техническое обоснование при выборе компонента;
- Подбор аналогов;
- Консультации по применению компонента;
- Поставка образцов и прототипов;
- Техническая поддержка проекта;
- Защита от снятия компонента с производства.



Как с нами связаться

Телефон: 8 (812) 309 58 32 (многоканальный)

Факс: 8 (812) 320-02-42

Электронная почта: org@eplast1.ru

Адрес: 198099, г. Санкт-Петербург, ул. Калинина, дом 2, корпус 4, литера А.