

### FEATURES

Enhanced Replacement for LF441 and TL061

DC Performance:

- 200  $\mu$ A max Quiescent Current
- 10 pA max Bias Current, Warmed Up (AD548C)
- 250  $\mu$ V max Offset Voltage (AD548C)
- 2  $\mu$ V/ $^{\circ}$ C max Drift (AD548C)
- 2  $\mu$ V p-p Noise, 0.1 Hz to 10 Hz

AC Performance:

- 1.8 V/ $\mu$ s Slew Rate
- 1 MHz Unity Gain Bandwidth

Available in Plastic and Hermetic Metal Can Packages  
and in Chip Form

Available in Tape and Reel in Accordance with  
EIA-481A Standard

MIL-STD-883B Parts Available

Dual Version Available: AD648

Surface-Mount (SOIC) Package Available

### PRODUCT DESCRIPTION

The AD548 is a low power, precision monolithic operational amplifier. It offers both low bias current (10 pA max, warmed up) and low quiescent current (200  $\mu$ A max) and is fabricated with ion-implanted FET and laser wafer trimming technologies. Input bias current is guaranteed over the AD548's entire common-mode voltage range.

The economical J grade has a maximum guaranteed input offset voltage of less than 2 mV and an input offset voltage drift of less than 20  $\mu$ V/ $^{\circ}$ C. This level of dc precision is achieved utilizing Analog's laser wafer drift trimming process. The combination of low quiescent current and low offset voltage drift minimizes changes in input offset voltage due to self-heating effects.

The AD548 is recommended for any dual supply op amp application requiring low power and excellent dc and ac performance. In applications such as battery-powered, precision instrument front ends and CMOS DAC buffers, the AD548's excellent combination of low input offset voltage and drift, low bias current, and low 1/f noise reduces output errors. High common-mode rejection (82 dB, min on the "B" grade) and high open-loop gain ensures better than 12-bit linearity in high impedance, buffer applications.

The AD548 is pinned out in a standard op amp configuration and is available in three performance grades. The AD548J and AD548K are rated over the commercial temperature range of 0 $^{\circ}$ C to 70 $^{\circ}$ C. The AD548B is rated over the industrial temperature range of -40 $^{\circ}$ C to +85 $^{\circ}$ C.

The AD548 is available in an 8-lead plastic mini-DIP and surface-mount (SOIC) packages.

### REV. D

Information furnished by Analog Devices is believed to be accurate and reliable. However, no responsibility is assumed by Analog Devices for its use, nor for any infringements of patents or other rights of third parties that may result from its use. No license is granted by implication or otherwise under any patent or patent rights of Analog Devices.

### CONNECTION DIAGRAMS

Plastic Mini-DIP (N) Package  
and  
SOIC (R) Package

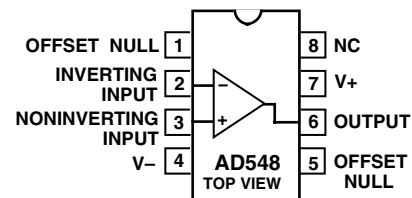

NOTE: PIN 4 CONNECTED TO CASE  
NC = NO CONNECT

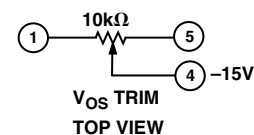

### PRODUCT HIGHLIGHTS

1. A combination of low supply current, excellent dc and ac performance and low drift makes the AD548 the ideal op amp for high performance, low power applications.
2. The AD548 is pin compatible with industry standard op amps such as the LF441, TL061, and AD542, enabling designers to improve performance while achieving a reduction in power dissipation of up to 85%.
3. Guaranteed low input offset voltage (2 mV max) and drift (20  $\mu$ V/ $^{\circ}$ C max) for the AD548J are achieved utilizing Analog Devices' laser drift trimming technology, eliminating the need for external trimming.
4. Analog Devices specifies each device in the warmed-up condition, insuring that the device will meet its published specifications in actual use.
5. A dual version, the AD648, is also available.
6. Enhanced replacement for LF441 and TL061.

# AD548—SPECIFICATIONS (@ 25°C and $V_S = \pm 15$ V dc unless otherwise noted.)

Parameter	AD548J			AD548K/B			Unit
	Min	Typ	Max	Min	Typ	Max	
<b>INPUT OFFSET VOLTAGE<sup>1</sup></b>							
Initial Offset		0.75	2.0		0.3	0.5	mV
$T_{MIN}$ to $T_{MAX}$ vs. Temperature			3.0/3.0/3.0			0.7/0.8	mV
vs. Supply	80		20	86		5	$\mu\text{V}/^\circ\text{C}$
vs. Supply, $T_{MIN}$ to $T_{MAX}$	76/76/76			80			dB
Long-Term Offset Stability		15			15		dB
							$\mu\text{V}/\text{Month}$
<b>INPUT BIAS CURRENT</b>							
Either Input <sup>2</sup> , $V_{CM} = 0$		5	20		3	10	pA
Either Input <sup>2</sup> at $T_{MAX}$ , $V_{CM} = 0$			0.45/1.3/20			0.25/0.65	nA
Max Input Bias Current Over Common-Mode Voltage Range			30			15	pA
Offset Current, $V_{CM} = 0$		5	10		2	5	pA
Offset Current at $T_{MAX}$			0.25/0.65/10			0.15/0.35	nA
<b>INPUT IMPEDANCE</b>							
Differential		$1 \times 10^{12} \parallel 3$			$1 \times 10^{12} \parallel 3$		$\Omega \parallel \text{pF}$
Common Mode		$3 \times 10^{12} \parallel 3$			$3 \times 10^{12} \parallel 3$		$\Omega \parallel \text{pF}$
<b>INPUT VOLTAGE RANGE</b>							
Differential <sup>3</sup>		$\pm 20$			$\pm 20$		V
Common Mode	$\pm 11$	$\pm 12$		$\pm 11$	$\pm 12$		V
Common-Mode Rejection							dB
$V_{CM} = \pm 10$ V	76	90		82	92		dB
$T_{MIN}$ to $T_{MAX}$	76/76/76	90		82	92		dB
$V_{CM} = \pm 11$ V	70	84		76	86		dB
$T_{MIN}$ to $T_{MAX}$	70/70/70	84		76	86		dB
<b>INPUT VOLTAGE NOISE</b>							
Voltage 0.1 Hz to 10 Hz		2			2		$\mu\text{V p-p}$
$f = 10$ Hz		80			80		$\text{nV}/\sqrt{\text{Hz}}$
$f = 100$ Hz		40			40		$\text{nV}/\sqrt{\text{Hz}}$
$f = 1$ kHz		30			30		$\text{nV}/\sqrt{\text{Hz}}$
$f = 10$ kHz		30			30		$\text{nV}/\sqrt{\text{Hz}}$
<b>INPUT CURRENT NOISE</b>							
$f = 1$ kHz		1.8			1.8		$\text{fA}/\sqrt{\text{Hz}}$
<b>FREQUENCY RESPONSE</b>							
Unity Gain, Small Signal	0.8	1.0		0.8	1.0		MHz
Full Power Response		30			30		kHz
Slew Rate, Unity Gain	1.0	1.8		1.0	1.8		V/ $\mu\text{s}$
Settling Time to $\pm 0.01\%$		8			8		$\mu\text{s}$
<b>OPEN LOOP GAIN</b>							
$V_O = \pm 10$ V, $R_L \geq 10$ k $\Omega$	300	1000		300	1000		3V/mV
$T_{MIN}$ to $T_{MAX}$ , $R_L \geq 10$ k $\Omega$	300/300/300	700		300	700		V/mV
$V_O = \pm 10$ V, $R_L \geq 5$ k $\Omega$	150	500		150	500		V/mV
$T_{MIN}$ to $T_{MAX}$ , $R_L \geq 5$ k $\Omega$	150/150/150	300		150	300		V/mV
<b>OUTPUT CHARACTERISTICS</b>							
Voltage @ $R_L \geq 10$ k $\Omega$ , $T_{MIN}$ to $T_{MAX}$	$\pm 12$	$\pm 13$		$\pm 12$	$\pm 13$		V
Voltage @ $R_L \geq 5$ k $\Omega$ , $T_{MIN}$ to $T_{MAX}$	$\pm 12/\pm 12/\pm 12$			$\pm 12$			V
Short Circuit Current	$\pm 11$	$\pm 12.3$		$\pm 11$	$\pm 12.3$		V
	$\pm 11/\pm 11/\pm 11$			$\pm 11$			V
		15			15		mA

## SPECIFICATIONS (continued)

	AD548J			AD548K/B			Unit
	Min	Typ	Max	Min	Typ	Max	
<b>POWER SUPPLY</b>							
Rated Performance		±15			±15		V
Operating Range	±4.5		±18	±4.5		±18	V
Quiescent Current		170	200		170	200	μA
<b>TEMPERATURE RANGE</b>							
Operating, Rated Performance							
Commercial (0°C to 70°C)		AD548J			AD548K		
Industrial (−40°C to +85°C)		AD548A			AD548B		
Military (−55°C to +125°C)		AD548S					
<b>PACKAGE OPTIONS</b>							
SOIC (R-8)	AD548JR			AD548KR <sup>4</sup>			
Plastic (N-8)	AD548JN <sup>4</sup>			AD548KN			
Tape and Reel	AD548JR-REEL			AD548KR-REEL <sup>4</sup>			

## NOTES

<sup>1</sup>Input Offset Voltage specifications are guaranteed after five minutes of operation at  $T_A = 25^\circ\text{C}$ .

<sup>2</sup>Bias Current specifications are guaranteed maximum at either input after five minutes of operation at  $T_A = 25^\circ\text{C}$ . For higher temperature, the current doubles every  $10^\circ\text{C}$ .

<sup>3</sup>Defined as voltages between inputs, such that neither exceeds  $\pm 10$  V from ground.

<sup>4</sup>Not recommended for new designs; obsolete April 2002.

Specifications subject to change without notice.

# AD548

## ABSOLUTE MAXIMUM RATINGS<sup>1</sup>

Supply Voltage	±18 V
Internal Power Dissipation <sup>2</sup>	500 mW
Input Voltage <sup>3</sup>	±18 V
Output Short Circuit Duration	Indefinite
Differential Input Voltage	+V <sub>S</sub> and -V <sub>S</sub>
Storage Temperature Range (Q, H)	-65°C to +150°C
(N, R)	-65°C to +125°C
Operating Temperature Range	
AD548J/K	0°C to 70°C
AD548B	-40°C to +85°C
Lead Temperature Range (Soldering 60 sec)	300°C

## NOTES

<sup>1</sup>Stresses above those listed under Absolute Maximum Ratings may cause permanent damage to the device. This is a stress rating only; functional operation of the device at these or any other conditions above those indicated in the operational sections of this specification is not implied. Exposure to absolute maximum rating conditions for extended periods may affect device reliability.

<sup>2</sup>Thermal Characteristics: 8-Pin SOIC Package:  $\theta_{JA} = 160^{\circ}\text{C}/\text{W}$ ,  $\theta_{JC} = 42^{\circ}\text{C}/\text{W}$ ; 8-Lead Plastic Package:  $\theta_{JA} = 90^{\circ}\text{C}/\text{W}$ .

<sup>3</sup>For supply voltages less than ±18 V, the absolute maximum input voltage is equal to the supply voltage.

## CAUTION

ESD (electrostatic discharge) sensitive device. Electrostatic charges as high as 4000 V readily accumulate on the human body and test equipment and can discharge without detection. Although the AD548 features proprietary ESD protection circuitry, permanent damage may occur on devices subjected to high-energy electrostatic discharges. Therefore, proper ESD precautions are recommended to avoid performance degradation or loss of functionality.



# Typical Performance Characteristics—AD548

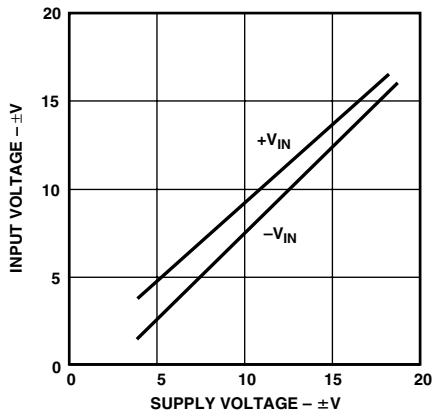

TPC 1. Input Voltage Range vs. Supply Voltage

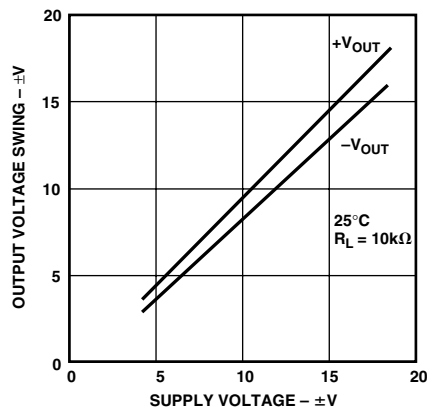

TPC 2. Output Voltage Swing vs. Supply Voltage

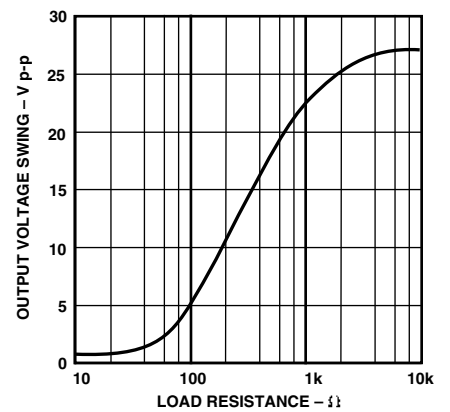

TPC 3. Output Voltage Swing vs. Load Resistance

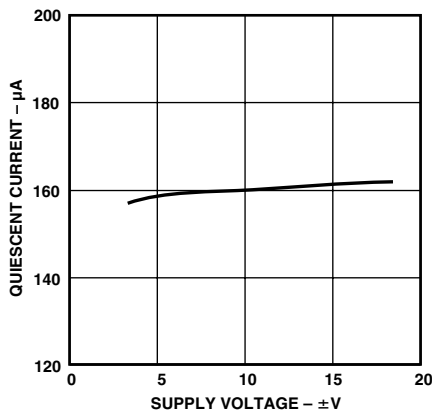

TPC 4. Quiescent Current vs. Supply Voltage

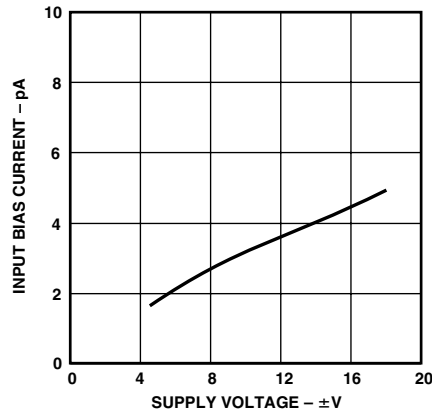

TPC 5. Input Bias Current vs. Supply Voltage

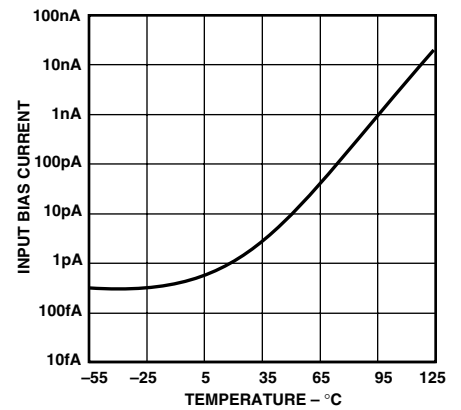

TPC 6. Input Bias Current vs. Temperature

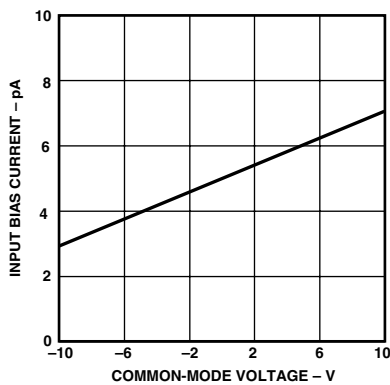

TPC 7. Input Bias Current vs. Common-Mode Voltage

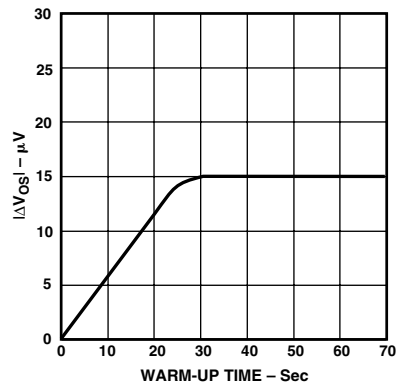

TPC 8. Change in Offset Voltage vs. Warm-Up Time

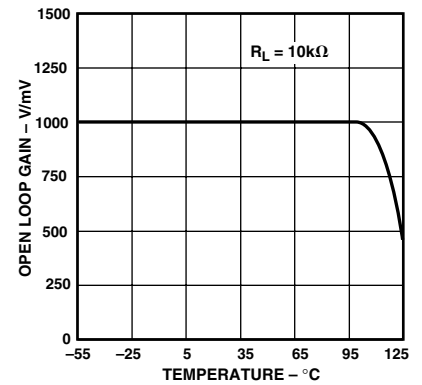

TPC 9. Open-Loop Gain vs. Temperature

# AD548

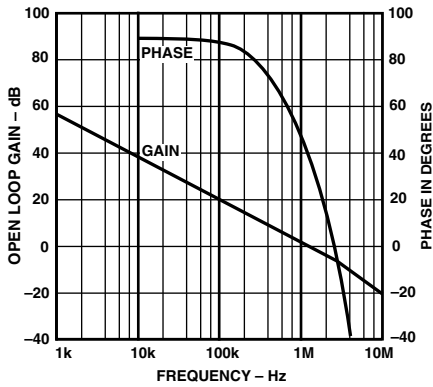

TPC 10. Open-Loop Frequency Response

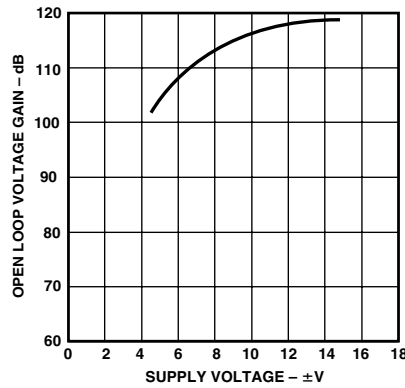

TPC 11. Open-Loop Voltage Gain vs. Supply Voltage

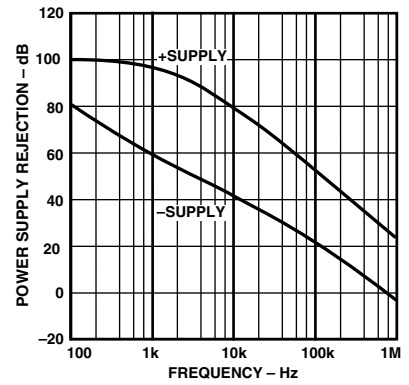

TPC 12. PSRR vs. Frequency

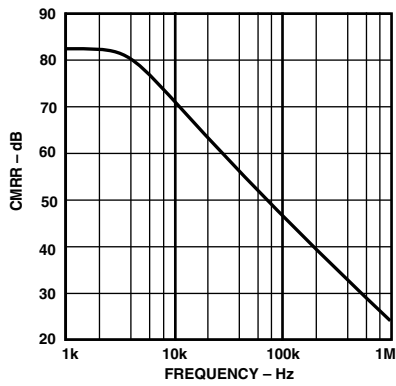

TPC 13. CMRR vs. Frequency

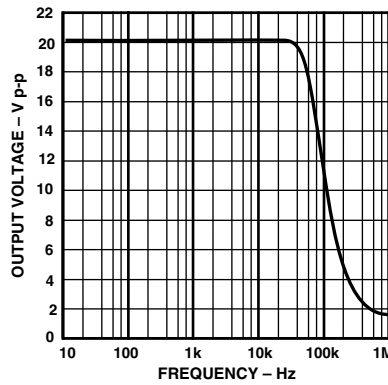

TPC 14. Large Signal Frequency Response

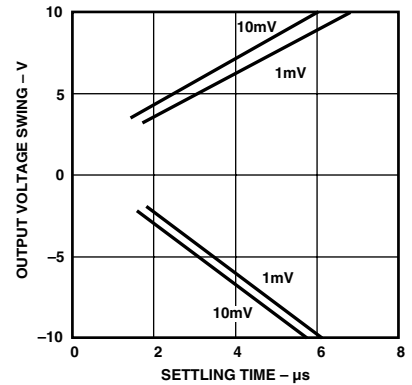

TPC 15. Output Swing and Error Voltage vs. Output Settling Time

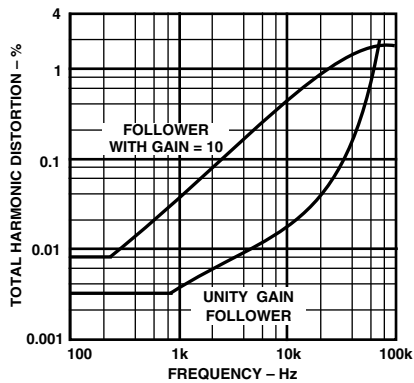

TPC 16. Total Harmonic Distortion vs. Frequency

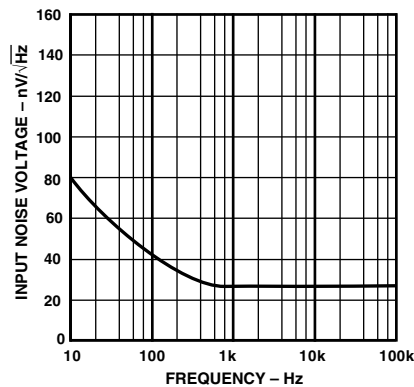

TPC 17. Input Noise Voltage vs. Frequency

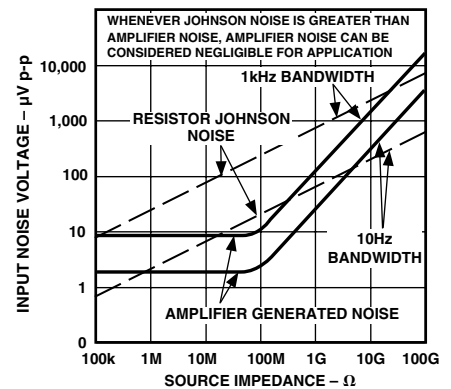

TPC 18. Total Noise vs. Source Impedance

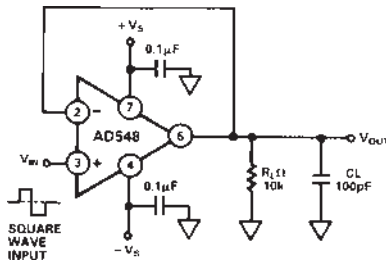

TPC 19a. Unity Gain Follower

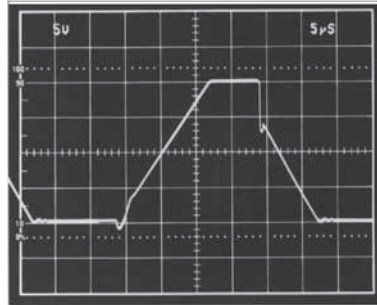

TPC 19b. Unity Gain Follower Pulse Response (Large Signal)

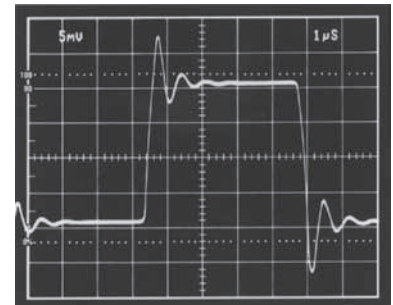

TPC 19c. Unity Gain Follower Pulse Response (Small Signal)

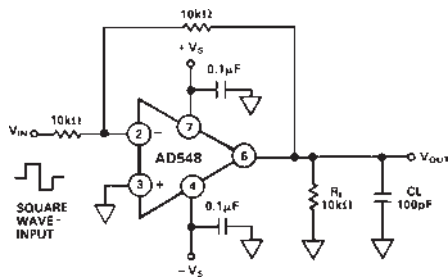

TPC 20a. Utility Gain Inverter

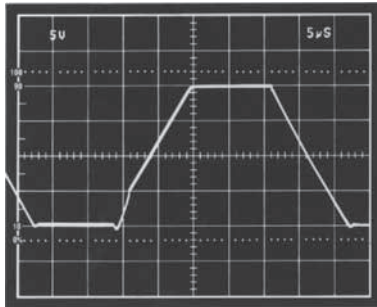

TPC 20b. Utility Gain Inverter Pulse Response (Large Signal)

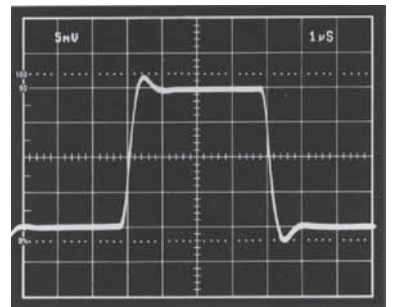

TPC 20c. Utility Gain Inverter Pulse Response (Small Signal)

## APPLICATION NOTES

The AD548 is a JFET-input op amp with a guaranteed maximum  $I_B$  of less than 10 pA, and offset and drift laser-trimmed to 0.5 mV and 5  $\mu\text{V}/^\circ\text{C}$ , respectively (AD548B). AC specs include 1 MHz bandwidth, 1.8 V/ $\mu\text{s}$  typical slew rate and 8  $\mu\text{s}$  settling time for a 20 V step to  $\pm 0.01\%$ —all at a supply current less than 200  $\mu\text{A}$ . To capitalize on the device's performance, a number of error sources should be considered.

The minimal power drain and low offset drift of the AD548 reduce self-heating or "warm-up" effects on input offset voltage, making the AD548 ideal for on/off battery-powered applications. The power dissipation due to the AD548's 200  $\mu\text{A}$  supply current has a negligible effect on input current, but heavy output loading will raise the chip temperature. Since a JFET's input current doubles for every 10 $^\circ\text{C}$  rise in chip temperature, this can be a noticeable effect.

The amplifier is designed to be functional with power supply voltages as low as  $\pm 4.5$  V. It will exhibit a higher input offset voltage than at the rated supply voltage of  $\pm 15$  V, due to power supply rejection effects. The common-mode range of the AD548 extends from 3 V more positive than the negative supply to 1 V more negative than the positive supply. Designed to cleanly drive up to 10 k $\Omega$  and 100 pF loads, the AD548 will drive a 2 k $\Omega$  load with reduced open-loop gain.

## OFFSET NULLING

Unlike bipolar input amplifiers, zeroing the input offset voltage of a BiFET op amp will not minimize offset drift. Using balance Pins 1 and 5 to adjust the input offset voltage as shown in Figure 1 will induce an added drift of 0.24  $\mu\text{V}/^\circ\text{C}$  per 100  $\mu\text{V}$  of nulled offset. The low initial offset (0.5 mV) of the AD548B results in only 0.6  $\mu\text{V}/^\circ\text{C}$  of additional drift.

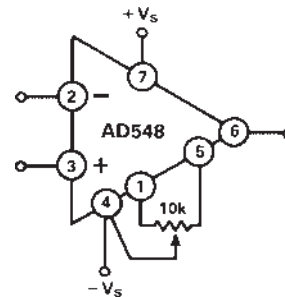

Figure 1. Offset Null Configuration

## LAYOUT

To take full advantage of the AD548's 10 pA max input current, parasitic leakages must be kept below an acceptable level. The practical limit of the resistance of epoxy or phenolic circuit board material is between  $1 \times 10^{12} \Omega$  and  $3 \times 10^{12} \Omega$ . This can result in an additional leakage of 5 pA between an input of 0 V and a -15 V supply line. Teflon<sup>®</sup> or a similar low leakage material (with a resistance exceeding  $10^{17} \Omega$ ) should be used to isolate high impedance input lines from adjacent lines carrying high voltages. The insulator should be kept clean, since contaminants will degrade the surface resistance.

A metal guard completely surrounding the high impedance nodes and driven by a voltage near the common-mode input potential can also be used to reduce some parasitic leakages. The guarding pattern in Figure 2 will reduce parasitic leakage due to finite board surface resistance; but it will not compensate for a low volume resistivity board.

Teflon is a registered trademark of DuPont.

# AD548

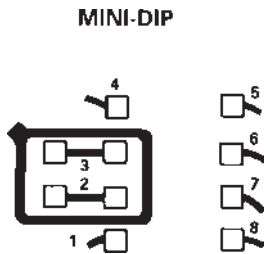

Figure 2. Board Layout for Guarding Inputs

## INPUT PROTECTION

The AD548 is guaranteed to withstand input voltages equal to the power supply potential. Exceeding the negative supply voltage on either input will forward bias the substrate junction of the chip. The induced current may destroy the amplifier due to excess heat.

Input protection is required in applications such as a flame detector in a gas chromatograph, where a very high potential may be applied to the input terminals during a sensor fault condition. Figure 3 shows a simple current limiting scheme that can be used.  $R_{PROTECT}$  should be chosen such that the maximum overload current is 1.0 mA (100 k $\Omega$  for a 100 V overload, for example).

Exceeding the negative common-mode range on either input terminal causes a phase reversal at the output, forcing the amplifier output to the corresponding high or low state. Exceeding the negative common-mode on both inputs simultaneously forces the output high. Exceeding the positive common-mode range on a single input does not cause a phase reversal, but if both inputs exceed the limit the output will be forced high. In all cases, normal amplifier operation is resumed when input voltages are brought back within the common-mode range.

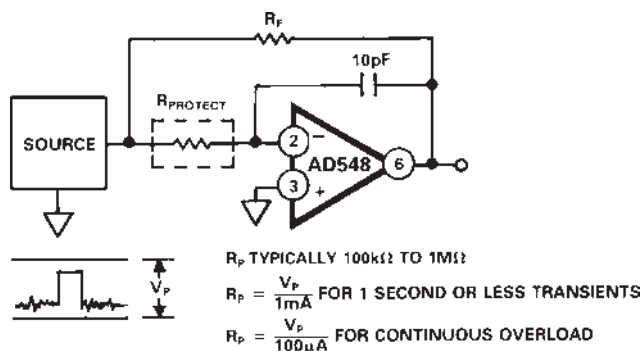

Figure 3. Input Protection of IV Converter

## D/A CONVERTER OUTPUT BUFFER

The circuit in Figure 4 shows the AD548 and AD7545 12-bit CMOS D/A converter in a unipolar binary configuration.  $V_{OUT}$  will be equal to  $V_{REF}$  attenuated by a factor depending on the digital word.  $V_{REF}$  sets the full scale. Overall gain is trimmed by adjusting  $R_{IN}$ . The AD548's low input offset voltage, low drift, and clean dynamics make it an attractive low power output buffer.

The input offset voltage of the AD548 output amplifier results in an output error voltage. This error voltage equals the input offset voltage of the op amp times the noise gain of the amplifier.

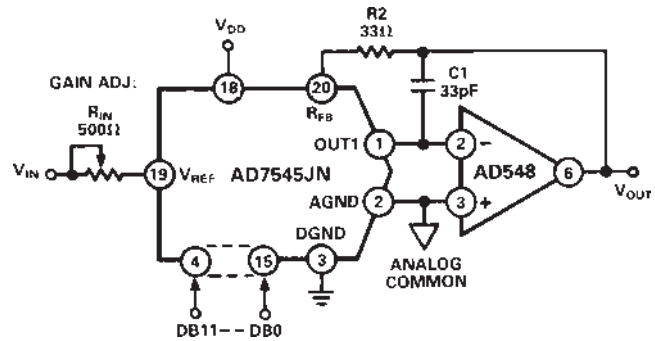

Figure 4. AD548 Used as DAC Output Amplifier That is:

$$V_{OS \text{ Output}} = V_{OS \text{ Input}} \left( 1 + \frac{R_{FB}}{R_O} \right)$$

$R_{FB}$  is the feedback resistor for the op amp, which is internal to the DAC.  $R_O$  is the DAC's R-2R ladder output resistance. The value of  $R_O$  is code dependent. This has the effect of changing the offset error voltage at the amplifier's output. An output amplifier with a sub millivolt input offset voltage is needed to preserve the linearity of the DAC's transfer function.

The AD548 in this configuration provides a 700 kHz small signal bandwidth and 1.8 V/ $\mu$ s typical slew rate. The 33 pF capacitor across the feedback resistor optimizes the circuit's response. The oscilloscope charts in Figures 5 and 6 show small and large signal outputs of the circuit in Figure 4. Upper traces show the input signal  $V_{IN}$ . Lower traces are the resulting output voltage with the DAC's digital input set to all 1s. The AD548 settles to  $\pm 0.01\%$  for a 20 V input step in 14  $\mu$ s.

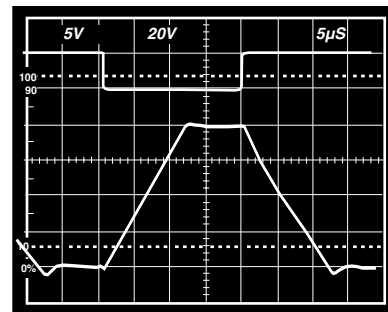

Figure 5. Response to  $\pm 20$  V p-p Reference Square Wave

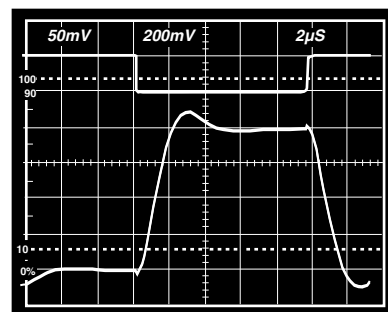

Figure 6. Response to  $\pm 100$  mV p-p Reference Square Wave



## PHOTODIODE PREAMP

The performance of the photodiode preamp shown in Figure 7 is enhanced by the AD548's low input current, input voltage offset, and offset voltage drift. The photodiode sources a current proportional to the incident light power on its surface.  $R_F$  converts the photodiode current to an output voltage equal to  $R_F \times I_S$ .

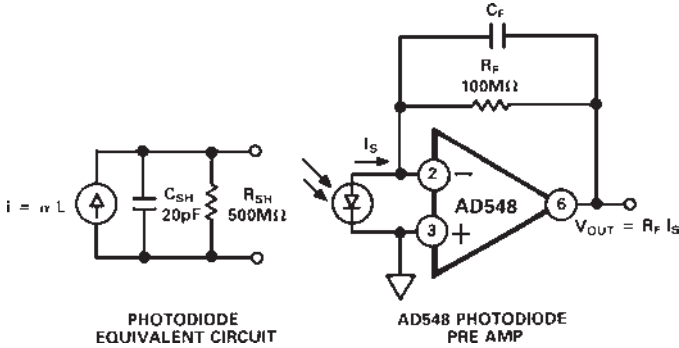

Figure 7.

An error budget illustrating the importance of low amplifier input current, voltage offset, and offset voltage drift to minimize output voltage errors can be developed by considering the equivalent circuit for the small (0.2 mm<sup>2</sup> area) photodiode shown in Figure 7. The input current results in an error proportional to the feedback resistance used. The amplifier's offset will produce an error proportional to the preamp's noise gain  $(1 + R_F/R_{SH})$ , where  $R_{SH}$  is the photodiode shunt resistance. The amplifier's input current will double with every 10°C rise in temperature, and the photodiode's shunt resistance halves with every 10°C rise. The error budget in Figure 8 assumes a room temperature photodiode  $R_{SH}$  of 500 MΩ, and the maximum input current and input offset voltage specs of an AD548C.

TEMP °C	$R_{SH}$ (MΩ)	$V_{OS}$ (μV)	$(1 + R_F/R_{SH}) V_{OS}$	$I_B$ (pA)	$I_B R_F$	TOTAL
-25	15,970	150	151 μV	0.30	30 μV	181 μV
0	2,830	200	207 μV	2.26	262 μV	469 μV
25	500	250	300 μV	10.00	1.0 mV	1.30 mV
50	88.5	300	640 μV	56.6	5.6 mV	6.24 mV
75	15.6	350	2.6 mV	320	32 mV	34.6 mV
85	7.8	370	5.1 mV	640	64 mV	69.1 mV

Figure 8. Photodiode Preamp Errors Over Temperature

The capacitance at the amplifier's negative input (the sum of the photodiode's shunt capacitance, the op amp's differential input capacitance, stray capacitance due to wiring, etc.) will cause a rise in the preamp's noise gain over frequency. This can result in excess noise over the bandwidth of interest.  $C_F$  reduces the noise gain "peaking" at the expense of bandwidth.

## INSTRUMENTATION AMPLIFIER

The AD548C's maximum input current of 10 pA makes it an excellent building block for the high input impedance instrumentation amplifier shown in Figure 9. Total current drain for this circuit is under 600 μA. This configuration is optimal for conditioning differential voltages from high impedance sources. The overall gain of the circuit is controlled by  $R_G$ , resulting in the following transfer function:

$$\frac{V_{OUT}}{V_{IN}} = 1 + \frac{(R_1 + R_2)}{R_G}$$

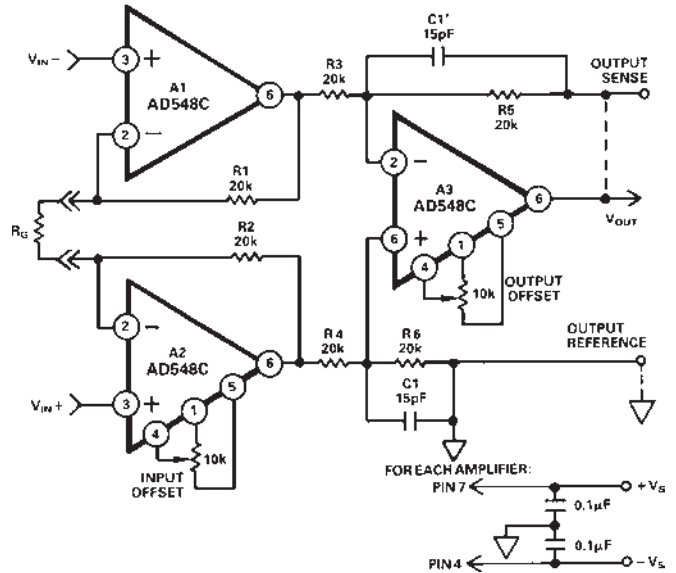

Figure 9. Low Power Instrumentation Amplifier

Gains of 1 to 100 can be accommodated with gain nonlinearities of less than 0.01%. Input errors, which contribute an output error proportional to in amp gain, include a maximum untrimmed input offset voltage of 0.5 mV and an input offset voltage drift over temperature of 4 μV/°C. Output errors, which are independent of gain, will contribute an additional 0.5 mV offset and 4 μV/°C drift. The maximum input current is 15 pA over the common-mode range, with a common-mode impedance of over  $1 \times 10^{12} \Omega$ . Resistor pairs  $R_3/R_5$  and  $R_4/R_6$  should be ratio matched to 0.01% to take full advantage of the AD548's high common-mode rejection. Capacitors  $C_1$  and  $C_1'$  compensate for peaking in the gain over frequency caused by input capacitance when gains of 1 to 3 are used.

The -3 dB small signal bandwidth for this low power instrumentation amplifier is 700 kHz for a gain of 1 and 10 kHz for a gain of 100. The typical output slew rate is 1.8 V/μs.

## LOG RATIO AMPLIFIER

Log ratio amplifiers are useful for a variety of signal conditioning applications, such as linearizing exponential transducer outputs and compressing analog signals having a wide dynamic range. The AD548's picoamp level input current and low input offset voltage make it a good choice for the front-end amplifier of the log ratio circuit shown in Figure 10. This circuit produces an output voltage equal to the log base 10 of the ratio of the input currents  $I_1$  and  $I_2$ . Resistive inputs  $R_1$  and  $R_2$  are provided for voltage inputs.

Input currents  $I_1$  and  $I_2$  set the collector currents of  $Q_1$  and  $Q_2$ , a matched pair of logging transistors. Voltages at points A and B are developed according to the following familiar diode equation:

$$V_{BE} = (kT/q) \ln (I_C / I_{ES})$$

In this equation,  $k$  is Boltzmann's constant,  $T$  is absolute temperature,  $q$  is an electron charge, and  $I_{ES}$  is the reverse saturation current of the logging transistors. The difference of these two voltages is taken by the subtractor section and scaled by a factor of approximately 16 by resistors  $R_9$ ,  $R_{10}$ , and  $R_8$ . Temperature

# AD548

compensation is provided by resistors R8 and R15 that have a positive 3500 ppm/°C temperature coefficient. The transfer function for the output voltage is:

$$V_{OUT} = 1V \log_{10} (I_2/I_1)$$

Frequency compensation is provided by R11, R12, C1, and C2. Small signal bandwidth is approximately 300 kHz at input currents above 100 μA and will proportionally decrease with lower signal levels. D1, D2, R13, and R14 compensate for the effects of the two logging transistors' ohmic emitter resistance.

To trim this circuit, set the two input currents to 10 μA and adjust  $V_{OUT}$  to zero by adjusting the potentiometer on A3. Then set  $I_2$  to 1 μA and adjust the scale factor such that the output voltage is 1 V by trimming potentiometer R10. Offset adjustment for A1 and A2 is provided to increase the accuracy of the voltage inputs.

This circuit ensures a 1% log conformance error over an input current range of 300 pA to 1 mA, with low level accuracy limited by the AD548's input current. The low level input voltage accuracy of this circuit is limited by the input offset voltage and drift of the AD548.

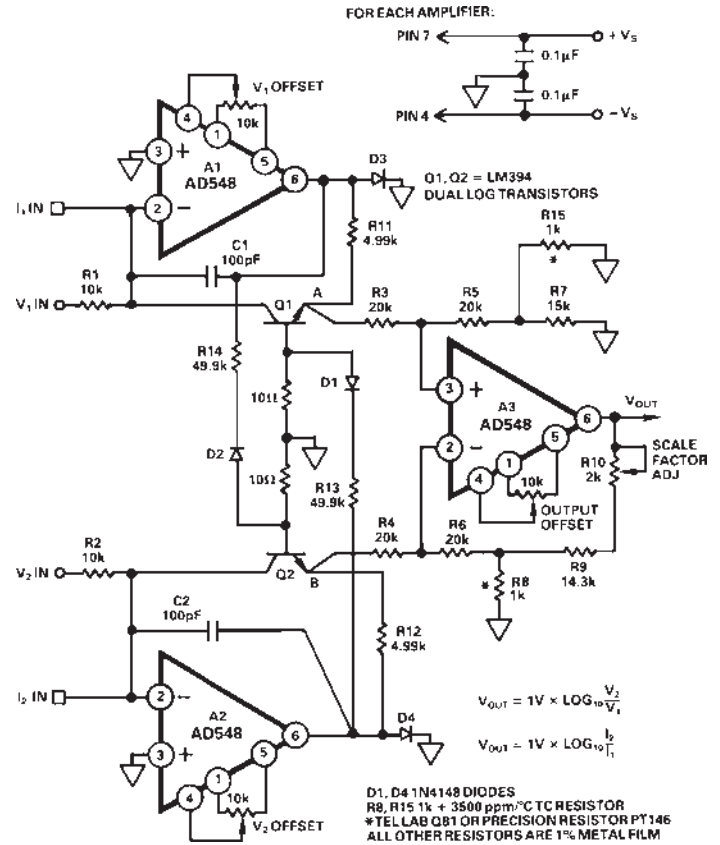
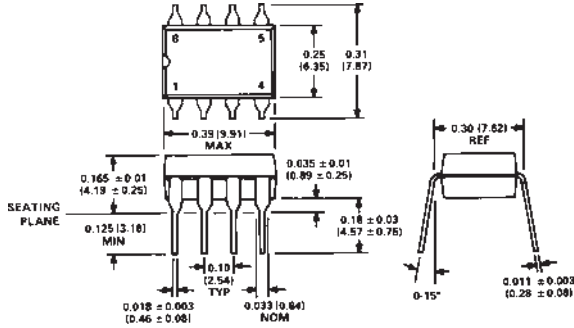

Figure 10. Log Ratio Amplifier

OUTLINE DIMENSIONS

**Plastic Mini-DIP (N) Package**

Dimensions shown in inches and (millimeters)



**SOIC (R) Package**

Dimensions shown in millimeters and (inches)

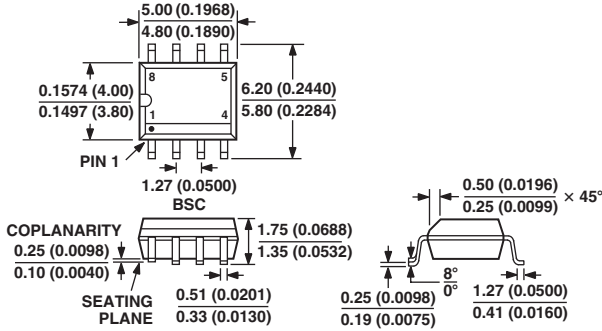

CONTROLLING DIMENSIONS ARE IN MILLIMETERS; INCH DIMENSIONS (IN PARENTHESES) ARE ROUNDED-OFF MILLIMETER EQUIVALENTS FOR REFERENCE ONLY AND ARE NOT APPROPRIATE FOR USE IN DESIGN  
 COMPLIANT TO JEDEC STANDARDS MS-012 AA

Revision History

Location	Page
<b>Data Sheet changed from REV. C to REV. D.</b>	
Change to SOIC (R-8) Package	11
Edits to FEATURES	1
Deleted TO-99 CONNECTION DIAGRAM	1
Deleted AD548C from SPECIFICATIONS	2
Edits to ABSOLUTE MAXIMUM RATINGS	3
Deleted Metal Can from Figure 22	6
Deleted TO-99 (H) and Cerdip (Q) Packages from OUTLINE DIMENSIONS	8





Компания «ЭлектроПласт» предлагает заключение долгосрочных отношений при поставках импортных электронных компонентов на взаимовыгодных условиях!

Наши преимущества:

- Оперативные поставки широкого спектра электронных компонентов отечественного и импортного производства напрямую от производителей и с крупнейших мировых складов;
- Поставка более 17-ти миллионов наименований электронных компонентов;
- Поставка сложных, дефицитных, либо снятых с производства позиций;
- Оперативные сроки поставки под заказ (от 5 рабочих дней);
- Экспресс доставка в любую точку России;
- Техническая поддержка проекта, помощь в подборе аналогов, поставка прототипов;
- Система менеджмента качества сертифицирована по Международному стандарту ISO 9001;
- Лицензия ФСБ на осуществление работ с использованием сведений, составляющих государственную тайну;
- Поставка специализированных компонентов (Xilinx, Altera, Analog Devices, Intersil, Interpoint, Microsemi, Aeroflex, Peregrine, Syfer, Eurofarad, Texas Instrument, Miteq, Cobham, E2V, MA-COM, Hittite, Mini-Circuits, General Dynamics и др.);

Помимо этого, одним из направлений компании «ЭлектроПласт» является направление «Источники питания». Мы предлагаем Вам помощь Конструкторского отдела:

- Подбор оптимального решения, техническое обоснование при выборе компонента;
- Подбор аналогов;
- Консультации по применению компонента;
- Поставка образцов и прототипов;
- Техническая поддержка проекта;
- Защита от снятия компонента с производства.



#### Как с нами связаться

**Телефон:** 8 (812) 309 58 32 (многоканальный)

**Факс:** 8 (812) 320-02-42

**Электронная почта:** [org@eplast1.ru](mailto:org@eplast1.ru)

**Адрес:** 198099, г. Санкт-Петербург, ул. Калинина, дом 2, корпус 4, литера А.