

**Feature -**

- small size
- bi-color LED illuminated available
- long electrical life cycles
- right angle and vertical PCB terminal

**Applications -**

- consumer products
- computer products
- instrumentation
- communication equipments

**SPECIFICATIONS**

SWITCH SPECIFICATIONS	
POLE - POSITION	1P1T, Right Angle Push on Type, with or w/o LED are Available
CONTACT RATING	12 V DC, 50 mA
CONTACT RESISTANCE	100 mΩ MAX. 1.5 V DC ; 100 mA, by Method of Voltage DROP
INSULATION RESISTANCE	100 MΩ MIN. 500 V DC
DIELECTRIC STRENGTH	Breakdown Is not Allowable ; 500 V AC for 1 Minute
OPERATING FORCE	160 ± 50 gf
OPERATING LIFE	500,000 cycles
OPERATING TEMPERATURE RANGE	-20°C ~ 70°C
TOTAL TRAVEL	0.2 ± 0.1 mm

LED SPECIFICATIONS							
	ATTENTION LEDs are Electrostatic Sensitive devices	Unit	Value / LED Color				
			Blue	Green	Red	White	Yellow
FORWARD CURRENT	If	mA	10	20	20	2	20
REVERSE VOLTAGE	Vr	V	5,0	5,0	5,0	5,0	5,0
REVERSE CURRENT	Ir	μA	10	10	10	10	10
FORWARD VOLTAGE	Vf	V	@ 10mA 3,0-4,0	2,1-2,5	2,0-2,5	@ 2mA 2,8-4,0	2,0-2,5
LUMINOUS INTENSITY	Iv	mcd	@ 10mA 200	800	1800	@ 2mA 12	1800

Physical and electrical information of LED will be provided upon customer's request on switches.

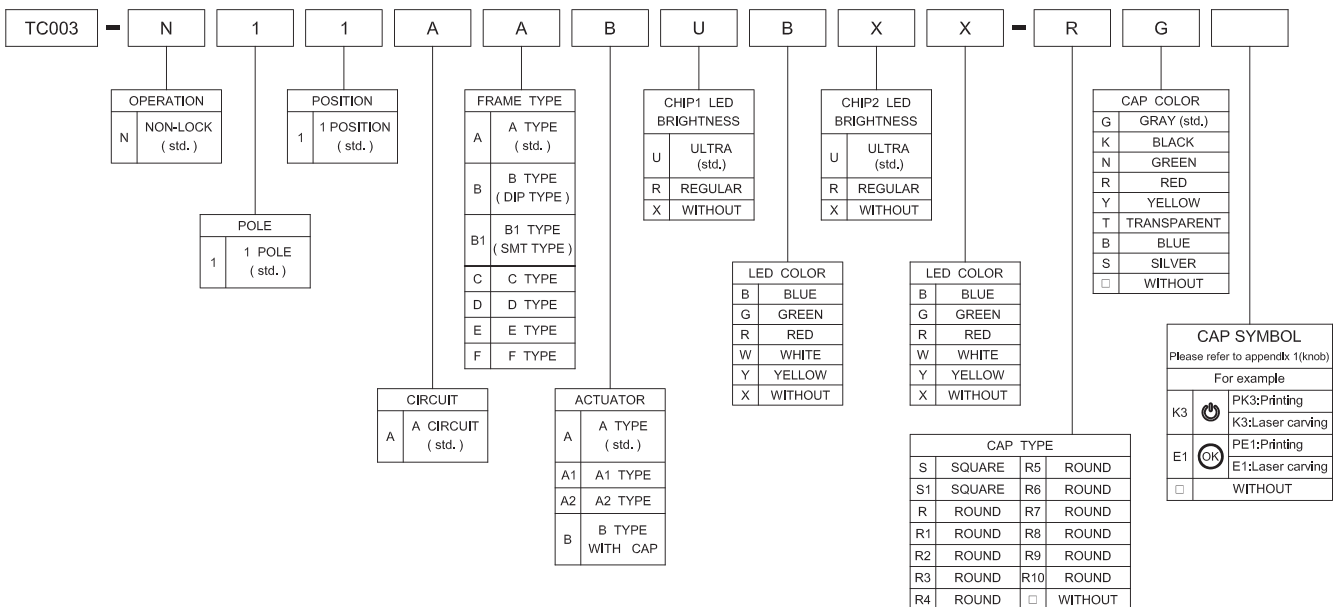
**HOW TO ORDER**

▶ **FRAME TYPE OPTION**

TYPE : A

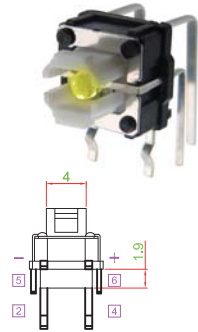
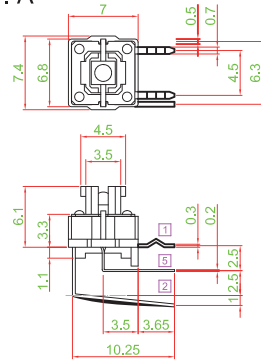

TYPE : B

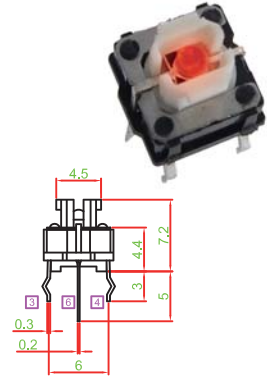
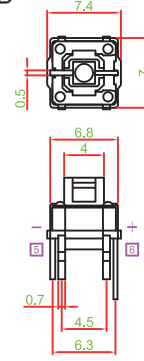

TYPE : C

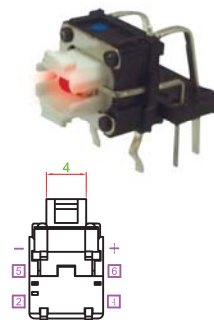
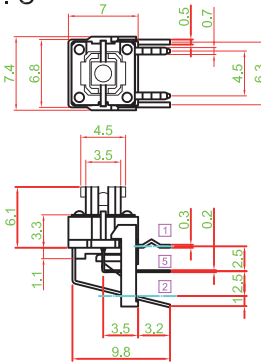

TYPE : B1

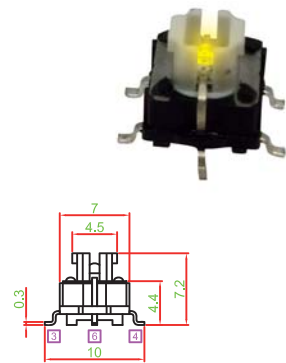
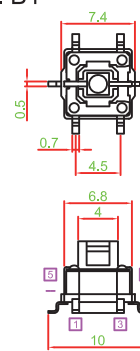

TYPE : D

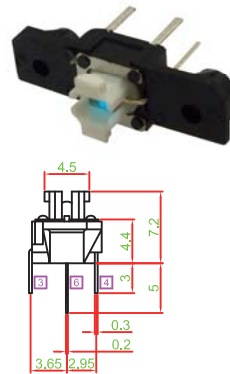
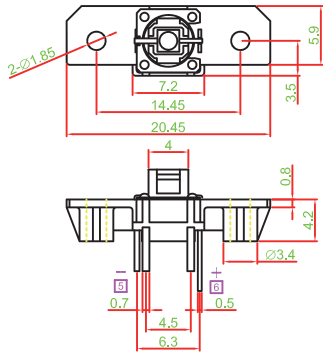

TYPE : E

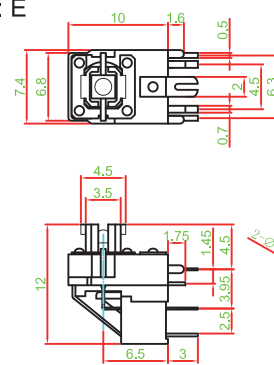

TYPE : F

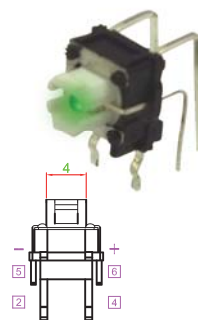
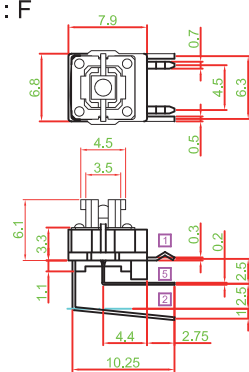

▶ **ACTUATOR TYPE OPTION**

TYPE : A

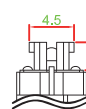

TYPE : A1

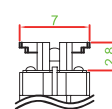

TYPE : A2

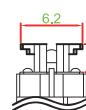

TYPE : B



**▶ KNOB TYPE OPTION**

<b>S TYPE</b> 	<b>S1 TYPE</b> 	<b>R TYPE</b> 
<b>R1 TYPE</b> 	<b>R2 TYPE</b> 	<b>R3 TYPE</b> 
<b>R4 TYPE</b> 	<b>R5 TYPE</b> 	<b>R6 TYPE</b> 
<b>R7 TYPE</b> 	<b>R8 TYPE (ODM)</b> 	<b>R9 TYPE (ODM)</b> 

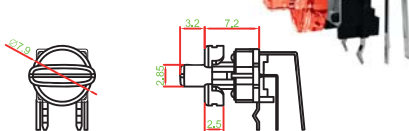
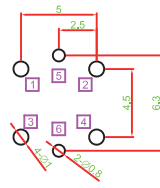
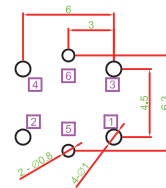
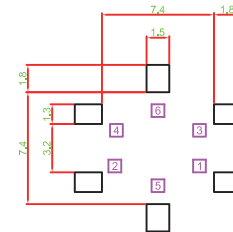
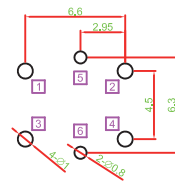
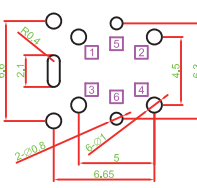
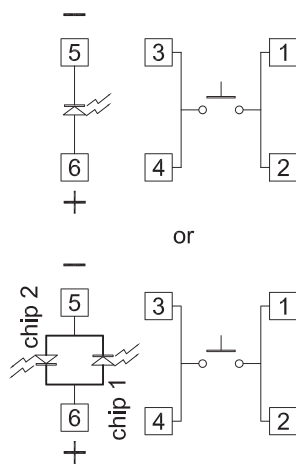
**R10 TYPE**

**▶ P.C.B LAYOUT**
**RIGHT ANGLE**

**FRAME : B**

**FRAME : B1**

**FRAME : D**

**FRAME : E**

**▶ SCHEMATIC**

**▶ MATERIAL**

- COVER : PA
- ACTUATOR : PA + GF
- BASE FRAME : PA + GF
- BRASS TERMINAL : SILVER PLATING
- STEADY PLATE : SUS

	0	1	2	3	4	5	6	7	8	9	10	11	12	13	14	15	16	17	18	19
A	0	1	2	3	4	5	6	7	8	9	10	11	12	13	14	15	16	17	18	19
B	A	B	C	D	E	F	G	H	I	J	CH5	CH6	DISK	PIP	C-KEY	CUT	TAKE	REC	ENG	PROG
C	K	L	M	N	O	P	Q	R	S	T	REPLAY	RET1	RET2	KEY ON	AUTO TAKE	A1	A2	A3	A4	0
D	U	V	W	X	Y	Z	POWER	ON OFF	ON	OFF	USER A	USER B	USER C	USER D	USER E	USER F	USER S	USER H	USER I	
E	OK	OK	Auto	Enter	Start	STOP	OPEN	CLOSE	Exit	Move	USER J	↶	✕	□	⏮	⏪	⏩	⏭	M-1	↷
F	SET	Reset	Light	Alarm	Menu	Next	Back	Delete	Motor	Save	⏪	⏩	⏮	⏭	✓1	✓2	☰	↑	↷	
G	Up	Down	Right	Left	Test	End	Insert	Lock	Print	+/-	🔑	⏪	⏩	☰	⏮					
H	ESC	BC.	HOME	Health	D-LED 2	OC GENIE	VIDEO INPUT	clr CMOS	Green Power	Save OK										
I	B/R	Undo Cancel	T/L	F1	F2	F3	F4	F5	F6	F7										
J	F8	F9	F10	F11	F12	F13	F14	IN 1	IN 2	IN 3										
K	IN 4	IN 5	IN 6	⏪	⏩	⏮	⏭	⏪	⏩	⏮	⏭	⏪								
L	+	-	×	÷	=	↑	→	▲	▶	▶										
M	↕	↔	↶	↷	↶	↷	↑	→	↑	→										
N	↑	→	▲	◀	▶	◀	▶	◀	▶											
O	■	⏪	↔	◀	▶	◀	▶	◀	▶	⏪	⏩	⏮	⏭							
P	☰	🔦	🔦	✕	✓	⏪	Config.	TIME LINE	ME1	ME2										
Q	ME3	ME4	BGND 3D DVE1	BGND 3D DVE2	BUS COLOR	ME BUTTON LINK	*	INSERT	WIPE	🔑										
R	⏪	ALL	🔇	VP	🔍	COPY	📄	RECORD MODE	↕	✕										
S	🔊	♥	MUTE	🔋	🔍	🔍	🔍	🔍	🔍	🔍										
T	🔍	🔍	group	🔍	🔍	🔍	🔍	🔍	🔍	🔍										
U	🔍	🔍	chair	🔍	🔍	🔍	🔍	🔍	🔍	🔍										
V	🔍	🔍	OC	🔍	🔍	CLEAR	CROSS WIND	AMMO TEMP	BARO PRESS	AIR TEMP										
W	BORE-SIGHT	CANT	LEAD	RANGE	MRS	ZERO	TEST	UD	LR	🔍										
X	ID	Dstep	MF	GALL	⊙	BAND	SETUP	MODE	LINK	FUNC.										
Y	SHIFT	🔍	🔍	🔍	🔍	DEL	🔍	🔍	🔍	🔍										
Z	🔍	🔍	🔍	RUN	2D	3D	CH1	CH2	CH3	CH4										



Компания «ЭлектроПласт» предлагает заключение долгосрочных отношений при поставках импортных электронных компонентов на взаимовыгодных условиях!

Наши преимущества:

- Оперативные поставки широкого спектра электронных компонентов отечественного и импортного производства напрямую от производителей и с крупнейших мировых складов;
- Поставка более 17-ти миллионов наименований электронных компонентов;
- Поставка сложных, дефицитных, либо снятых с производства позиций;
- Оперативные сроки поставки под заказ (от 5 рабочих дней);
- Экспресс доставка в любую точку России;
- Техническая поддержка проекта, помощь в подборе аналогов, поставка прототипов;
- Система менеджмента качества сертифицирована по Международному стандарту ISO 9001;
- Лицензия ФСБ на осуществление работ с использованием сведений, составляющих государственную тайну;
- Поставка специализированных компонентов (Xilinx, Altera, Analog Devices, Intersil, Interpoint, Microsemi, Aeroflex, Peregrine, Syfer, Eurofarad, Texas Instrument, Miteq, Cobham, E2V, MA-COM, Hittite, Mini-Circuits, General Dynamics и др.);

Помимо этого, одним из направлений компании «ЭлектроПласт» является направление «Источники питания». Мы предлагаем Вам помощь Конструкторского отдела:

- Подбор оптимального решения, техническое обоснование при выборе компонента;
- Подбор аналогов;
- Консультации по применению компонента;
- Поставка образцов и прототипов;
- Техническая поддержка проекта;
- Защита от снятия компонента с производства.



#### Как с нами связаться

**Телефон:** 8 (812) 309 58 32 (многоканальный)

**Факс:** 8 (812) 320-02-42

**Электронная почта:** [org@eplast1.ru](mailto:org@eplast1.ru)

**Адрес:** 198099, г. Санкт-Петербург, ул. Калинина, дом 2, корпус 4, литера А.