

# NCP1050, NCP1051, NCP1052, NCP1053, NCP1054, NCP1055

## Monolithic High Voltage Gated Oscillator Power Switching Regulator

The NCP1050 through NCP1055 are monolithic high voltage regulators that enable end product equipment to be compliant with low standby power requirements. This device series combines the required converter functions allowing a simple and economical power system solution for office automation, consumer, and industrial products. These devices are designed to operate directly from a rectified AC line source. In flyback converter applications they are capable of providing an output power that ranges from 6.0 W to 40 W with a fixed AC input of 100 V, 115 V, or 230 V, and 3.0 W to 20 W with a variable AC input that ranges from 85 V to 265 V.

This device series features an active startup regulator circuit that eliminates the need for an auxiliary bias winding on the converter transformer, fault detector and a programmable timer for converter overload protection, unique gated oscillator configuration for extremely fast loop response with double pulse suppression, power switch current limiting, input undervoltage lockout with hysteresis, thermal shutdown, and auto restart fault detection. These devices are available in economical 8-pin dual-in-line and 4-pin SOT-223 packages.

### Features

- Startup Circuit Eliminates the Need for Transformer Auxiliary Bias Winding
- Optional Auxiliary Bias Winding Override for Lowest Standby Power Applications
- Converter Output Overload and Open Loop Protection
- Auto Restart Fault Protection
- IC Thermal Fault Protection
- Unique, Dual Edge, Gated Oscillator Configuration for Extremely Fast Loop Response
- Oscillator Frequency Dithering with Controlled Slew Rate Driver for Reduced EMI
- Low Power Consumption Allowing European Blue Angel Compliance
- On-Chip 700 V Power Switch Circuit and Active Startup Circuit
- Rectified AC Line Source Operation from 85 V to 265 V
- Input Undervoltage Lockout with Hysteresis
- Oscillator Frequency Options of 44 kHz, 100 kHz, 136 kHz
- These are Pb-Free and Halide-Free Devices

### Typical Applications

- AC-DC Converters
- Wall Adapters
- Portable Electronic Chargers
- Low Power Standby and Keep-Alive Supplies



ON Semiconductor®

<http://onsemi.com>

### MARKING DIAGRAMS



PDIP-8  
P SUFFIX  
CASE 626A

- Pin: 1.  $V_{CC}$   
2. Control Input  
3, 7-8. Ground  
4. No Connection  
5. Power Switch Drain

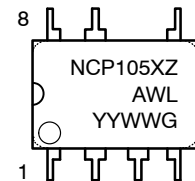

SOT-223  
ST SUFFIX  
CASE 318E

- Pin: 1.  $V_{CC}$   
2. Control Input  
3. Power Switch Drain  
4. Ground

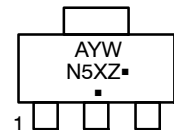

- X = Current Limit (0, 1, 2, 3, 4, 5)  
Z = Oscillator Frequency  
A = 44 kHz, B = 100 kHz, C = 136 kHz  
A = Assembly Location  
WL = Wafer Lot  
YY, Y = Year  
WW, W = Work Week  
G or ■ = Pb-Free Package  
(Note: Microdot may be in either location)

### ORDERING INFORMATION

See detailed ordering and shipping information on page 22 of this data sheet.

# NCP1050, NCP1051, NCP1052, NCP1053, NCP1054, NCP1055

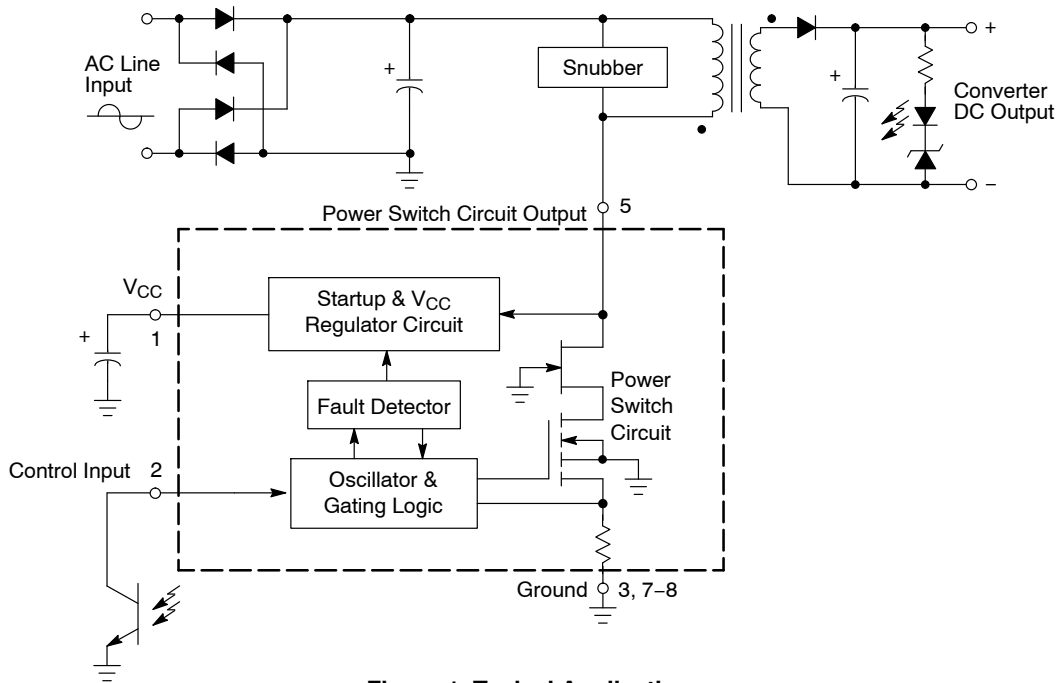

**Figure 1. Typical Application**

## Pin Function Description

| Pin (SOT-223) | Pin (PDIP-8) | Function           | Description   |
|---------------|--------------|--------------------|---|
| 1             | 1            | V <sub>CC</sub>    | This is the positive supply voltage input. During startup, power is supplied to this input from Pin 5. When V <sub>CC</sub> reaches V <sub>CC(on)</sub> , the Startup Circuit turns off and the output is allowed to begin switching with 1.0 V hysteresis on the V <sub>CC</sub> pin. The capacitance connected to this pin programs fault timing and frequency modulation rate. |
| 2             | 2            | Control Input      | The Power Switch Circuit is turned off when a current greater than approximately 50 μA is drawn out of or applied to this pin. A 10 V clamp is built onto the chip to protect the device from ESD damage or overvoltage conditions.   |
| 4             | 3, 7, 8      | Ground             | This pin is the control circuit and Power Switch Circuit ground. It is part of the integrated circuit lead frame.   |
| -             | 4            | No Connection      |   |
| 3             | 5            | Power Switch Drain | This pin is designed to directly drive the converter transformer primary, and internally connects to Power Switch and Startup Circuit.  |

NCP1050, NCP1051, NCP1052, NCP1053, NCP1054, NCP1055



Figure 2. Representative Block Diagram

NCP1050, NCP1051, NCP1052, NCP1053, NCP1054, NCP1055

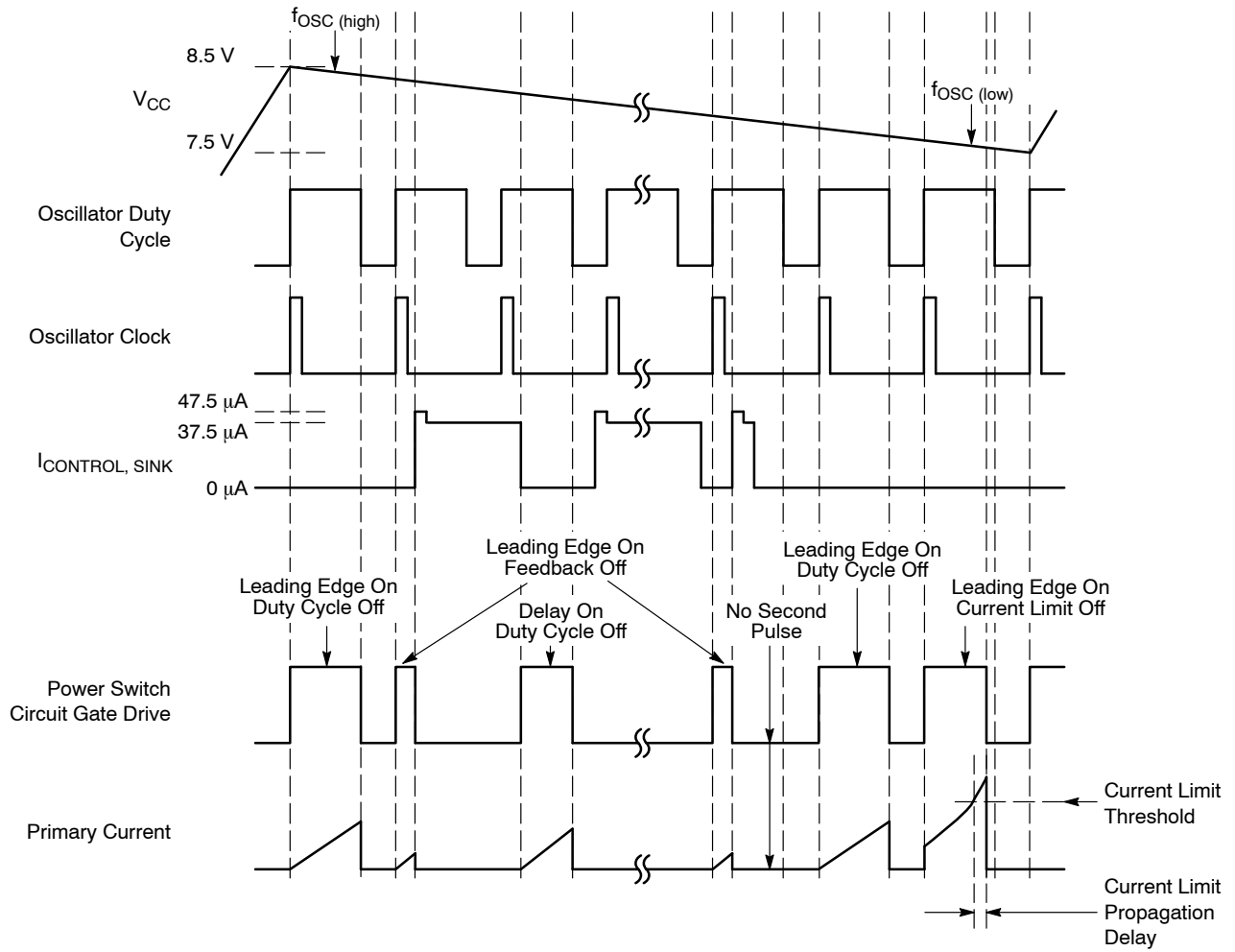

Figure 3. Timing Diagram for Gated Oscillator with Dual Edge PWM

NCP1050, NCP1051, NCP1052, NCP1053, NCP1054, NCP1055



Figure 4. Non-Latching Fault Condition Timing Diagram

# NCP1050, NCP1051, NCP1052, NCP1053, NCP1054, NCP1055

## MAXIMUM RATINGS

| Rating   | Symbol   | Value  | Unit                 |
|--|--|--|----------------------|
| Power Switch and Startup Circuit<br>Drain Voltage Range<br>Drain Current Peak During Transformer Saturation  | $V_{DS}$<br>$I_{DS(pk)}$   | - 0.3 to 700<br>$2.0 \times I_{lim} \text{ Max}$ | V<br>A               |
| Power Supply/ $V_{CC}$ Bypass and Control Input<br>Voltage Range<br>Current  | $V_{IR}$<br>$I_{max}$  | - 0.3 to 10<br>100                               | V<br>mA              |
| Thermal Characteristics<br>P Suffix, Plastic Package Case 626A-01<br>Junction-to-Lead<br>Junction-to-Air, 2.0 Oz. Printed Circuit Copper Clad<br>0.36 Sq. Inch<br>1.0 Sq. Inch<br>ST Suffix, Plastic Package Case 318E-04<br>Junction-to-Lead<br>Junction-to-Air, 2.0 Oz. Printed Circuit Copper Clad<br>0.36 Sq. Inch<br>1.0 Sq. Inch | $R_{\theta JL}$<br>$R_{\theta JA}$<br>$R_{\theta JL}$<br>$R_{\theta JA}$ | 9.0<br>77<br>60<br>14<br>74<br>55                | $^{\circ}\text{C/W}$ |
| Operating Junction Temperature   | $T_J$  | - 40 to +150                                     | $^{\circ}\text{C}$   |
| Storage Temperature  | $T_{stg}$  | - 65 to +150                                     | $^{\circ}\text{C}$   |

Maximum ratings are those values beyond which device damage can occur. Maximum ratings applied to the device are individual stress limit values (not normal operating conditions) and are not valid simultaneously. If these limits are exceeded, device functional operation is not implied, damage may occur and reliability may be affected.

A. This device series contains ESD protection and exceeds the following tests:

Pins 1-3: Human Body Model 2000 V per MIL-STD-883, Method 3015.

Machine Model Method 400 V.

Pin 5: Human Body Model 1000 V per MIL-STD-883, Method 3015.

Machine Model Method 400 V.

Pin 5 is connected to the power switch and start-up circuits, and is rated only to the max voltage of the part, or 700 V.

B. This device contains Latch-up protection and exceeds  $\pm 100$  mA per JEDEC Standard JESD78.

# NCP1050, NCP1051, NCP1052, NCP1053, NCP1054, NCP1055

**ELECTRICAL CHARACTERISTICS** ( $V_{CC} = 8.0\text{ V}$ , for typical values  $T_J = 25^\circ\text{C}$ , for min/max values,  $T_J$  is the operating junction temperature range that applies (Note 1), unless otherwise noted.)

| Characteristics  | Symbol   | Min                                | Typ                               | Max                                  | Unit          |
|--|--|------------------------------------|-----------------------------------|--------------------------------------|---------------|
| <b>OSCILLATOR</b>  |  |                                    |                                   |                                      |               |
| Frequency ( $V_{CC} = 7.5\text{ V}$ )<br>$T_J = 25^\circ\text{C}$ :<br>44 kHz Version<br>100 kHz Version<br>136 kHz Version<br>$T_J = T_{low}$ to $T_{high}$<br>44 kHz Version<br>100 kHz Version<br>136 kHz Version   | $f_{OSC(low)}$   | 38<br>87<br>119<br>37<br>84<br>113 | 42.5<br>97<br>132<br>–<br>–<br>–  | 47<br>107<br>145<br>47<br>107<br>145 | kHz           |
| Frequency ( $V_{CC} = 8.5\text{ V}$ )<br>$T_J = 25^\circ\text{C}$ :<br>44 kHz Version<br>100 kHz Version<br>136 kHz Version<br>$T_J = T_{low}$ to $T_{high}$<br>44 kHz Version<br>100 kHz Version<br>136 kHz Version   | $f_{OSC(high)}$  | 41<br>93<br>126<br>39<br>90<br>120 | 45.5<br>103<br>140<br>–<br>–<br>– | 50<br>113<br>154<br>50<br>113<br>154 | kHz           |
| Frequency Sweep ( $V_{CC} = 7.5\text{ V}$ to $8.5\text{ V}$ , $T_J = 25^\circ\text{C}$ )   | $\%f_{OSC}$  | –                                  | 5.0                               | –                                    | %             |
| Maximum Duty Cycle   | $D_{(max)}$  | 74                                 | 77                                | 80                                   | %             |
| <b>CONTROL INPUT</b>   |  |                                    |                                   |                                      |               |
| Lower Window Input Current Threshold<br>Switching Enabled, Sink Current Increasing<br>Switching Disabled, Sink Current Decreasing<br>Upper Window Input Current Threshold<br>Switching Enabled, Source Current Increasing<br>Switching Disabled, Source Current Decreasing | $I_{off(low)}$<br>$I_{on(low)}$<br>$I_{off(high)}$<br>$I_{on(high)}$ | –58<br>–50<br>37<br>25             | –47.5<br>–37.5<br>47.5<br>37.5    | –37<br>–25<br>58<br>50               | $\mu\text{A}$ |
| Control Window Input Voltage<br>Lower ( $I_{sink} = 25\ \mu\text{A}$ )<br>Upper ( $I_{source} = 25\ \mu\text{A}$ )   | $V_{low}$<br>$V_{high}$  | 1.1<br>4.2                         | 1.35<br>4.6                       | 1.6<br>5.0                           | V             |

1. Tested junction temperature range for the NCP105X series:  
 $T_{low} = -40^\circ\text{C}$        $T_{high} = +125^\circ\text{C}$

# NCP1050, NCP1051, NCP1052, NCP1053, NCP1054, NCP1055

**ELECTRICAL CHARACTERISTICS** ( $V_{CC} = 8.0$  V, for typical values  $T_J = 25^\circ\text{C}$ , for min/max values,  $T_J$  is the operating junction temperature range that applies (Note 2), unless otherwise noted.)

| Characteristics  | Symbol                                 | Min                                   | Typ                                    | Max                                    | Unit               |
|--|--|---------------------------------------|--|--|--------------------|
| <b>POWER SWITCH CIRCUIT</b>  |  |                                       |  |  |                    |
| Power Switch Circuit On-State Resistance<br>NCP1050, NCP1051, NCP1052 ( $I_D = 50$ mA)<br>$T_J = 25^\circ\text{C}$<br>$T_J = 125^\circ\text{C}$<br>NCP1053, NCP1054, NCP1055 ( $I_D = 100$ mA)<br>$T_J = 25^\circ\text{C}$<br>$T_J = 125^\circ\text{C}$    | $R_{DS(on)}$                           | –<br>–                                | 22<br>42                               | 30<br>55                               | $\Omega$           |
| Power Switch Circuit & Startup Breakdown Voltage<br>( $I_{D(off)} = 100$ $\mu\text{A}$ , $T_A = 25^\circ\text{C}$ )  | $V_{(BR)DS}$                           | 700                                   | –                                      | –                                      | V                  |
| Power Switch Circuit & Startup Circuit Off-State Leakage Current<br>( $V_{DS} = 650$ V) $T_J = 25^\circ\text{C}$<br>$T_J = 125^\circ\text{C}$  | $I_{DS(off)}$                          | –<br>–                                | 25<br>15                               | 40<br>80                               | $\mu\text{A}$      |
| Switching Characteristics ( $R_L = 50$ $\Omega$ , $V_{DS}$ set for $I_D = 0.7 I_{lim}$ )<br>Turn-on Time (90% to 10%)<br>Turn-off Time (10% to 90%)  | $t_{on}$<br>$t_{off}$                  | –<br>–                                | 20<br>10                               | –<br>–                                 | ns                 |
| <b>CURRENT LIMIT AND THERMAL PROTECTION</b>  |  |                                       |  |  |                    |
| Current Limit Threshold ( $T_J = 25^\circ\text{C}$ ) (Note 5)<br>NCP1050<br>NCP1051<br>NCP1052<br>NCP1053<br>NCP1054<br>NCP1055  | $I_{lim}$                              | 93<br>186<br>279<br>372<br>493<br>632 | 100<br>200<br>300<br>400<br>530<br>680 | 107<br>214<br>321<br>428<br>567<br>728 | mA                 |
| Conversion Power Deviation ( $T_J = 25^\circ\text{C}$ ) (Note 6)   | $I^2f_{OSC}$                           | –                                     | 0                                      | 10                                     | %A <sup>2</sup> Hz |
| Propagation Delay, Current Limit Threshold to Power Switch Circuit Output<br>NCP1050, NCP1051, NCP1052<br>NCP1053, NCP1054, NCP1055  | $t_{PLH}$                              | –<br>–                                | 135<br>160                             | –<br>–                                 | ns                 |
| Thermal Protection ( $V_{CC} = 8.6$ V) (Note 2, 3, 4)<br>Shutdown (Junction Temperature Increasing)<br>Hysteresis (Junction Temperature Decreasing)  | $T_{sd}$<br>$T_H$                      | 140<br>–                              | 160<br>75                              | –<br>–                                 | $^\circ\text{C}$   |
| <b>STARTUP CONTROL</b>   |  |                                       |  |  |                    |
| Startup/ $V_{CC}$ Regulation<br>Startup Threshold/ $V_{CC}$ Regulation Peak ( $V_{CC}$ Increasing)<br>Minimum Operating/ $V_{CC}$ Valley Voltage After Turn-On<br>Hysteresis   | $V_{CC(on)}$<br>$V_{CC(off)}$<br>$V_H$ | 8.0<br>7.0<br>–                       | 8.5<br>7.5<br>1.0                      | 9.0<br>8.0<br>–                        | V                  |
| Undervoltage Lockout Threshold Voltage, $V_{CC}$ Decreasing  | $V_{CC(reset)}$                        | 4.0                                   | 4.5                                    | 5.0                                    | V                  |
| Startup Circuit Output Current (Power Switch Circuit Output = 40 V)<br>$V_{CC} = 0$ V<br>$T_J = 25^\circ\text{C}$<br>$T_J = -40$ to $125^\circ\text{C}$<br>$V_{CC} = V_{CC(on)} - 0.2$ V<br>$T_J = 25^\circ\text{C}$<br>$T_J = -40$ to $125^\circ\text{C}$ | $I_{start}$                            | 5.4<br>4.5<br>4.6<br>3.5              | 6.3<br>–<br>5.6<br>–                   | 7.2<br>8.0<br>6.6<br>7.0               | mA                 |
| Minimum Start-up Drain Voltage ( $I_{start} = 0.5$ mA, $V_{CC} = V_{CC(on)} - 0.2$ V)  | $V_{start(min)}$                       | –                                     | 13.4                                   | 20                                     | V                  |
| Output Fault Condition Auto Restart<br>( $V_{CC}$ Capacitor = 10 $\mu\text{F}$ , Power Switch Circuit Output = 40 V)<br>Average Switching Duty Cycle<br>Frequency  | $D_{rst}$<br>$f_{rst}$                 | –<br>–                                | 6.0<br>3.5                             | –<br>–                                 | %<br>Hz            |

- Tested junction temperature range for the NCP105X series:  
 $T_{low} = -40^\circ\text{C}$   $T_{high} = +125^\circ\text{C}$
- Maximum package power dissipation limits must be observed.
- Guaranteed by design only.
- Adjust di/dt to reach  $I_{lim}$  in 4.0  $\mu\text{sec}$ .
- Consult factory for additional options including test and trim for output power accuracy.



# NCP1050, NCP1051, NCP1052, NCP1053, NCP1054, NCP1055

**ELECTRICAL CHARACTERISTICS** ( $V_{CC} = 8.0\text{ V}$ , for typical values  $T_J = 25^\circ\text{C}$ , for min/max values,  $T_J$  is the operating junction temperature range that applies (Note 7), unless otherwise noted.)

| Characteristics                                  | Symbol    | Min   | Typ   | Max  | Unit |
|--|-----------|-------|-------|------|------|
| <b>TOTAL DEVICE</b>                              |           |       |       |      |      |
| Power Supply Current After UVLO Turn-On (Note 8) |           |       |       |      |      |
| Power Switch Circuit Enabled                     | $I_{CC1}$ |       |       |      | mA   |
| NCP1050, NCP1051, NCP1052                        |           |       |       |      |      |
| 44 kHz Version                                   |           | 0.35  | 0.45  | 0.55 |      |
| 100 kHz Version                                  |           | 0.40  | 0.50  | 0.60 |      |
| 136 kHz Version                                  |           | 0.40  | 0.525 | 0.65 |      |
| NCP1053, NCP1054, NCP1055                        |           |       |       |      |      |
| 44 kHz Version                                   | 0.40      | 0.50  | 0.60  |      |      |
| 100 kHz Version                                  | 0.45      | 0.575 | 0.70  |      |      |
| 136 kHz Version                                  | 0.50      | 0.65  | 0.80  |      |      |
| Power Switch Circuit Disabled                    |           |       |       |      |      |
| Non-Fault Condition                              | $I_{CC2}$ | 0.35  | 0.45  | 0.55 |      |
| Fault Condition                                  | $I_{CC3}$ | 0.10  | 0.175 | 0.25 |      |

7. Tested junction temperature range for the NCP105X series:

$$T_{\text{low}} = -40^\circ\text{C} \quad T_{\text{high}} = +125^\circ\text{C}$$

8. See Non-Latching Fault Condition Timing Diagram in Figure 4.

**NCP1050, NCP1051, NCP1052, NCP1053, NCP1054, NCP1055**



**Figure 5. Oscillator Frequency (44 kHz Version) versus Temperature**



**Figure 6. Oscillator Frequency (100 kHz Version) versus Temperature**



**Figure 7. Oscillator Frequency (136 kHz Version) versus Temperature**



**Figure 8. Frequency Sweep versus Temperature**

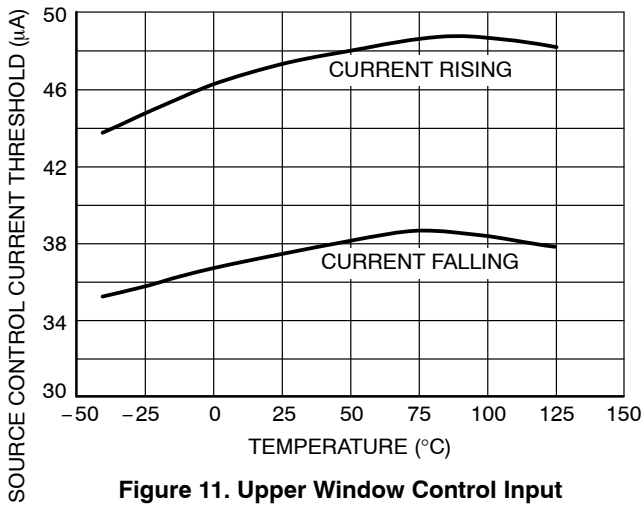

**Figure 9. Maximum Duty Cycle versus Temperature**

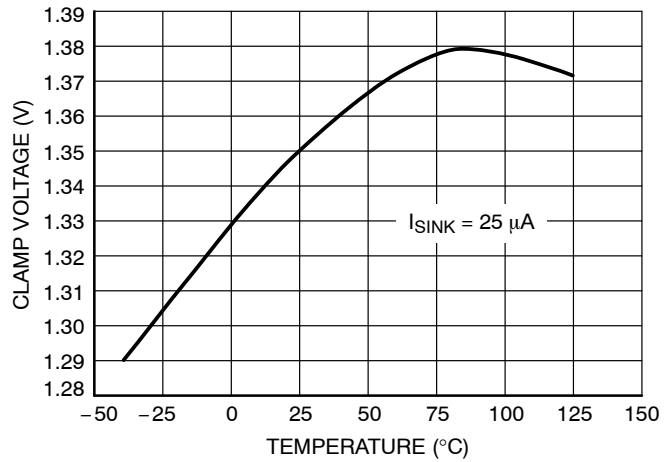

**Figure 10. Lower Window Control Input Current Thresholds versus Temperature**

# NCP1050, NCP1051, NCP1052, NCP1053, NCP1054, NCP1055



**Figure 11. Upper Window Control Input Current Thresholds versus Temperature**



**Figure 12. Control Input Lower Window Clamp Voltage versus Temperature**



**Figure 13. Control Input Upper Window Clamp Voltage versus Temperature**



**Figure 14. On Resistance versus Temperature**

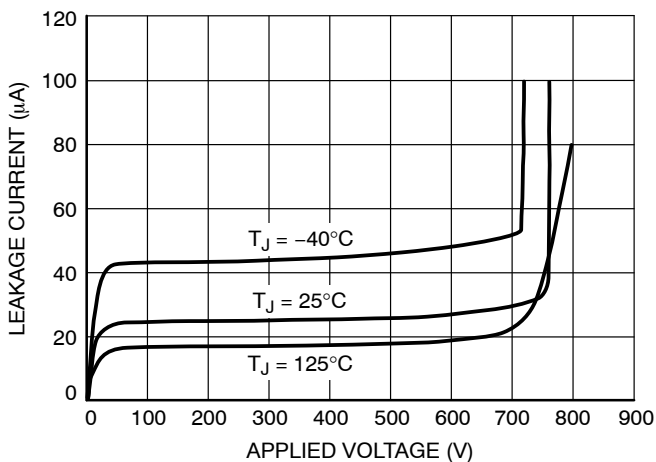

**Figure 15. Power Switch and Startup Circuit Leakage Current versus Voltage**



**Figure 16. Power Switch and Startup Circuit Output Capacitance versus Applied Voltage**

NCP1050, NCP1051, NCP1052, NCP1053, NCP1054, NCP1055



Figure 17. Normalized Peak Current Limit versus Temperature



Figure 18. Supply Voltage Thresholds versus Temperature

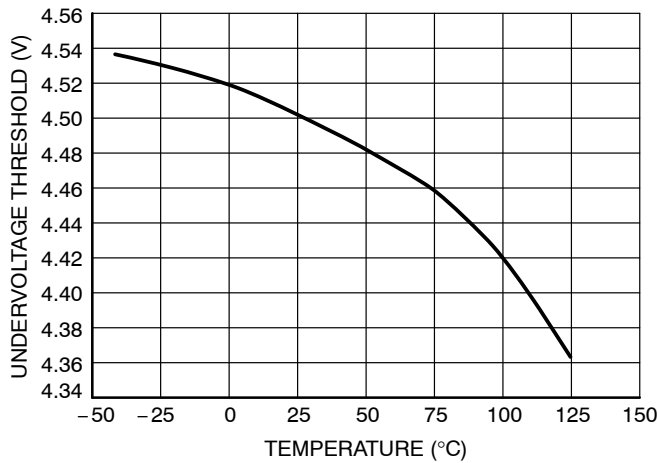

Figure 19. Undervoltage Lockout Threshold versus Temperature

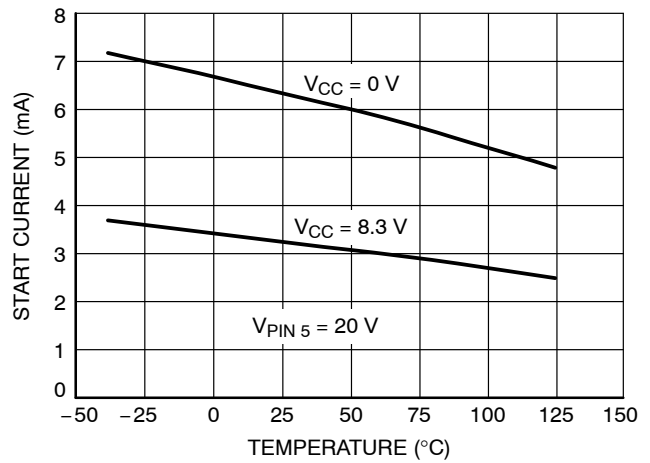

Figure 20. Start Current versus Temperature

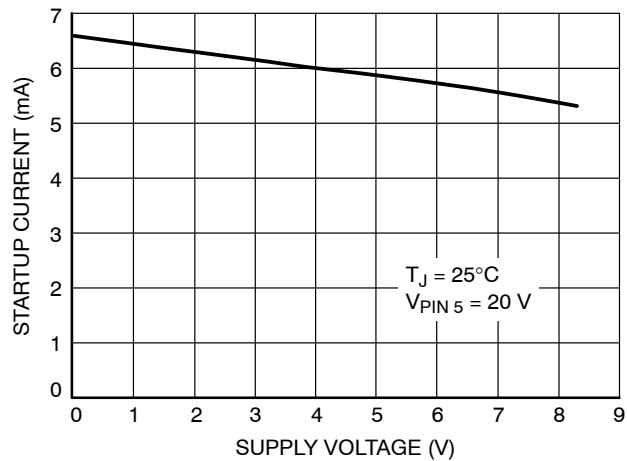

Figure 21. Startup Current versus Supply Voltage



Figure 22. Startup Current versus Pin 5 Voltage

**NCP1050, NCP1051, NCP1052, NCP1053, NCP1054, NCP1055**



**Figure 23. Supply Current versus Temperature (NCP1050/1/2)**



**Figure 24. Supply Current versus Temperature (NCP1053/4/5)**



**Figure 25. Supply Current When Switching Disable versus Temperature**



**Figure 26. Supply Current in Fault Condition versus Temperature**



**Figure 27. Supply Voltage versus Temperature**

## OPERATING DESCRIPTION

**Introduction**

The NCP105X series represents a new higher level of integration by providing on a single monolithic chip all of the active power, control, logic, and protection circuitry required to implement a high voltage flyback converter and compliance with very low standby power requirements for modern consumer electronic power supplies. This device series is designed for direct operation from a rectified 240 VAC line source and requires minimal external components for a complete cost sensitive converter solution. Potential markets include cellular phone chargers, standby power supplies for personal computers, secondary bias supplies for microprocessor keep-alive supplies and IR detectors. A description of each of the functional blocks is given below, and the representative block diagram is shown in Figure 2.

This device series features an active startup regulator circuit that eliminates the need for an auxiliary bias winding on the converter transformer, fault logic with a programmable timer for converter overload protection, unique gated oscillator configuration for extremely fast loop response with double pulse suppression, oscillator frequency dithering with a controlled slew rate driver for reduced EMI, cycle-by-cycle current limiting, input undervoltage lockout with hysteresis, thermal shutdown, and auto restart or latched off fault detect device options. These devices are available in economical 8-pin PDIP and 4-pin SOT-223 packages.

**Oscillator**

The Oscillator is a unique fixed-frequency, duty-cycle-controlled oscillator. It charges and discharges an on chip timing capacitor to generate a precise square wave signal used to pulse width modulate the Power Switch Circuit. During the discharge of the timing capacitor, the Oscillator duty cycle output holds one input of the Driver low. This action keeps the Power Switch Circuit off, thus limiting the maximum duty cycle.

A frequency modulation feature is incorporated into the IC in order to aide in EMI reduction. Figure 3 illustrates this frequency modulation feature. The power supply voltage,  $V_{CC}$ , acts as the input to the built-in voltage controlled oscillator. As the  $V_{CC}$  voltage is swept across its nominal operating range of 7.5 to 8.5 V, the oscillator frequency is swept across its corresponding range.

The center oscillator frequency is internally programmed for 44 kHz, 100 kHz, or 136 kHz operation with a controlled charge to discharge current ratio that yields a maximum Power Switch duty cycle of 77%. The Oscillator temperature characteristics are shown in Figures 5 through 9. Contact an ON Semiconductor sales representative for further information regarding frequency options.

**Control Input**

The Control Input pin circuit has parallel source follower input stages with voltage clamps set at 1.35 and 4.6 V. Current sources clamp the input current through the

followers at approximately 47.5  $\mu\text{A}$  with 10  $\mu\text{A}$  hysteresis. When a source or sink current in excess of this value is applied to this input, a logic signal generated internally changes state to block power switch conduction. Since the output of the Control Input sense is sampled continuously during  $t_{\text{on}}$  (77% duty cycle), it is possible to turn the Power Switch Circuit on or off at any time within  $t_{\text{on}}$ . Because it does not have to wait for the next cycle (rising edge of the clock signal) to switch on, and because it does not have to wait for current limit to turn off, the circuit has a very fast transient response as shown in Figure 3.

In a typical converter application the control input current is drawn by an optocoupler. The collector of the optocoupler is connected to the Control Input pin and the emitter is connected to ground. The optocoupler LED is mounted in series with a shunt regulator (typically a TL431) at the DC output of the converter. When the power supply output is greater than the reference voltage (shunt regulator voltage plus optocoupler diode voltage drop), the optocoupler turns on, pulling down on the Control Input. The control input logic is configured for line input sensing as well.

**Turn On Latch**

The Oscillator output is typically a 77% positive duty cycle square waveform. This waveform is inverted and applied to the reset input of the turn-on latch to prevent any power switch conduction during the guaranteed off time. This square wave is also gated by the output of the control section and applied to the set input of the same latch. Because of this gating action, the power switch can be activated when the control input is not asserted and the oscillator output is high.

The use of this unique gated Turn On Latch over an ordinary Gated Oscillator allows a faster load transient response. The power switch is allowed to turn on immediately, within the maximum duty cycle time period, when the control input signals a necessary change in state.

**Turn Off Latch**

A Turn Off Latch feature has been incorporated into this device series to protect the power switch circuit from excessive current, and to reduce the possibility of output overshoot in reaction to a sudden load removal. If the Power Switch current reaches the specified maximum current limit, the Current Limit Comparator resets the Turn Off Latch and turns the Power Switch Circuit off. The turn off latch is also reset when the Oscillator output signal goes low or the Control Input is asserted, thus terminating output MOSFET conduction. Because of this response to control input signals, it provides a very fast transient response and very tight load regulation. The turn off latch has an edge triggered set input which ensures that the switch can only be activated once during any oscillator period. This is commonly referred to as double pulse suppression.

## Current Limit Comparator and Power Switch Circuit

The Power Switch Circuit is constructed with a SENSEFET™ in order to monitor the drain current. A portion of the current flowing through the circuit goes into a sense element,  $R_{sense}$ . The current limit comparator detects if the voltage across  $R_{sense}$  exceeds the reference level that is present at its inverting input. If this level is exceeded, the comparator quickly resets the Turn Off Latch, thus protecting the Power Switch Circuit.

A Leading Edge Blanking circuit was placed in the current sensing signal path to prevent a premature reset of the Turn Off Latch. A potential premature reset signal is generated each time the Power Switch Circuit is driven into conduction and appears as a narrow voltage spike across current sense resistor  $R_{sense}$ . The spike is due to the Power Switch Circuit gate to source capacitance, transformer interwinding capacitance, and output rectifier recovery time. The Leading Edge Blanking circuit has a dynamic behavior that masks the current signal until the Power Switch Circuit turn-on transition is completed. The current limit propagation delay time is typically 135 to 165 nanoseconds. This time is measured from when an overcurrent appears at the Power Switch Circuit drain, to the beginning of turn-off. Care must be taken during transformer saturation so that the maximum device current limit rating is not exceeded.

The high voltage Power Switch Circuit is monolithically integrated with the control logic circuitry and is designed to directly drive the converter transformer. Because the characteristics of the power switch circuit are well known, the gate drive has been tailored to control switching transitions to help limit electromagnetic interference (EMI). The Power Switch Circuit is capable of switching 700 V with an associated drain current that ranges nominally from 0.10 to 0.68 Amps.

## Startup Circuit

Rectified AC line voltage is applied to the Startup Circuit on Pin 5, through the primary winding. The circuit is self-biasing and acts as a constant current source, gated by control logic. Upon application of the AC line voltage, this circuit routes current into the supply capacitor typically connected to Pin 1. During normal operation, this capacitor is hysteretically regulated from 7.5 to 8.5 V by monitoring the supply voltage with a comparator and controlling the startup current source accordingly. This Dynamic Self-Supply (DSS) functionality offers a great deal of applications flexibility as well. The startup circuit is rated at a maximum 700 V (maximum power dissipation limits must be observed).

## Undervoltage Lockout

An Undervoltage Lockout (UVLO) comparator is included to guarantee that the integrated circuit has sufficient voltage to be fully functional. The UVLO comparator monitors the supply capacitor input voltage at Pin 1 and disables the Power Switch Circuit whenever the capacitor voltage drops below the undervoltage lockout threshold. When this level is crossed, the controller enters a new startup phase by turning the current source on. The supply voltage will then have to exceed the startup threshold in order to turn off the startup current source. Startup and normal operation of the converter are shown in Figure 3.

## Fault Detector

The NCP105X series has integrated Fault Detector circuitry for detecting application fault conditions such as open loop, overload or a short circuited output. A timer is generated by driving the supply capacitor with a known current and hysteretically regulating the supply voltage between set thresholds. The timer period starts when the supply voltage reaches the nominal upper threshold of 8.5 V and stops when the drain current of the integrated circuit draws the supply capacitor voltage down to the undervoltage lockout threshold of 7.5 V.

If, during this timer period, no feedback has been applied to the control input, the fault detect logic is set to indicate an abnormal condition. This may occur, for example, when the optocoupler fails or the output of the application is overloaded or completely shorted. In this case, the part will stop switching, go into a low power mode, and begin to draw down the supply capacitor to the reset threshold voltage of 4.5 V. At that time, the startup circuit will turn on again to drive the supply to the turn on threshold. Then the part will begin the cycle again, effectively sampling the control input to determine if the fault condition has been removed. This mode is commonly referred to as burst mode operation and is shown in Figure 4.

Proper selection of the supply capacitor allows successful startup with monotonically increasing output voltage, without falsely sensing a fault condition. Figure 4 shows successful startup and the evolution of the signals involved in the presence of a fault.

## Thermal Shutdown

The internal Thermal Shutdown block protects the device in the event that the maximum junction temperature is exceeded. When activated, typically at 160°C, one input of the Driver is held low to disable the Power Switch Circuit. The Power Switch is allowed to resume operation when the junction temperature falls below 85°C. The thermal shutdown feature is provided to prevent catastrophic device failures from accidental overheating. It is not intended to be used as a substitute for proper heatsinking.

## APPLICATIONS

Two application examples have been provided in this document, and they are described in detail in this section. Figure 28 shows a Universal Input, 6 Watt Converter Application as well as a 5.5 Watt Charger Application using the NCP1053 @ 100 kHz. The Charger consists of the additional components Q1, C13, and R7 through R10, as shown. These were constructed and tested using the printed circuit board layout shown in Figure 40. The board consists of a fiberglass epoxy material (FR4) with a single side of two ounce per square foot (70  $\mu\text{m}$  thick) copper foil. Test data from the two applications is given in Figures 29 through 39.

Both applications generate a well-regulated output voltage over a wide range of line input voltage and load current values. The charger application transitions to a constant current output if the load current is increased beyond a preset range. This can be very effective for battery charger application for portable products such as cellular telephones, personal digital assistants, and pagers. Using the NCP105X series in applications such as these offers a wide range of flexibility for the system designer.

The NCP105X application offers a low cost alternative to other applications. It uses a Dynamic Self-Supply (DSS) function to generate its own operating supply voltage such that an auxiliary transformer winding is not needed. (It also offers the flexibility to override this function with an auxiliary winding if ultra-low standby power is the designer's main concern.) This product also provides for automatic output overload, short circuit, and open loop protection by entering a programmable duty cycle burst mode of operation. This eliminates the need for expensive devices overrated for power dissipation or maximum current, or for redundant feedback loops.

The application shown in Figure 28 can be broken down into sections for the purpose of operating description. Components C1, L1 and C6 provide EMI filtering for the design, although this is very dependent upon board layout, component type, etc. D1 through D4 along with C2 provide the AC to bulk DC rectification. The NCP1053 drives the primary side of the transformer, and the capacitor, C5, is an integral part of the Dynamic Self-Supply. R1, C3, and D5 comprise an RCD snubber and R2 and C4 comprise a ringing damper both acting together to protect the IC from voltage transients greater than 700 volts and reduce radiated noise from the converter. Diode D6 along with C7-9, L2, C11, and C12 rectify the transformer secondary and filter the output

to provide a tightly regulated DC output. IC3 is a shunt regulator that samples the output voltage by virtue of R5 and R6 to provide drive to the optocoupler, IC2, Light Emitting Diode (LED). C10 is used to compensate the shunt regulator. When the application is configured as a Charger, Q1 delivers additional drive to the optocoupler LED when in constant current operation by sampling the output current through R7 and R8.

### Component Selection Guidelines

Choose snubber components R1, C3, and D5 such that the voltage on pin 5 is limited to the range from 0 to 700 volts. These components protect the IC from substrate injection if the voltage was to go below zero volts, and from avalanche if the voltage was to go above 700 volts, at the cost of slightly reduced efficiency. For lower power design, a simple RC snubber as shown, or connected to ground, can be sufficient. Ensure that these component values are chosen based upon the worst-case transformer leakage inductance and worst-case applied voltage. Choose R2 and C4 for best performance radiated switching noise.

Capacitor C5 serves multiple purposes. It is used along with the internal startup circuitry to provide power to the IC in lieu of a separate auxiliary winding. It also serves to provide timing for the oscillator frequency sweep for limiting the conducted EMI emissions. The value of C5 will also determine the response during an output fault (overload or short circuit) or open loop condition as shown in Figure 4, along with the total output capacitance.

Resistors R5 and R6 will determine the regulated output voltage along with the reference voltage chosen with IC3.

The base to emitter voltage drop of Q1 along with the value of R7 will set the fixed current limit value of the Charger application. R9 is used to limit the base current of Q1. Component R8 can be selected to keep the current limit fixed with very low values of output voltage or to provide current limit foldback with results as shown in Figures 29 and 33. A relatively large value of R8 allows for enough output voltage to effectively drive the optocoupler LED for fixed current limit. A low value of R8, along with resistor R10, provides for a low average output power using the fault protection feature when the output voltage is very low. C13 provides for output voltage stability when the Charger application is in current limit.



NCP1050, NCP1051, NCP1052, NCP1053, NCP1054, NCP1055



T1: COOPER ELECTRONIC TECHNOLOGIES  
 PART # CTX22-15348  
 PRIMARY: 97 turns of #29 AWG, Pin 4 = start, Pin 5 = finish  
 SECONDARY: 5 turns of 0.40 mm, Pins 2 and 1 = start, Pins 7 and 8 = finish  
 GAP: Designed for Total 1.24 mH Primary Inductance  
 CORE: TSF-7070  
 BOBBIN: Pins 3 and 6 Removed, EE19

\* Add Q1, C13, and R7-R10, and Change R4 to 2.0 kΩ for Charger Output

Figure 28. Universal Input 6/5 Watt Converter/Charger Application

**NCP1050, NCP1051, NCP1052, NCP1053, NCP1054, NCP1055**

| Test                           | Conditions  | Converter Results                             | Charger Results                               |
|--------------------------------|---|---|---|
| Line Regulation                | $V_{in} = 85 - 265 V_{AC}; I_{out} = 120 \text{ mA}$<br>$I_{out} = 600 \text{ mA}$<br>$I_{out} = 1.2 \text{ A}$   | 2 mV<br>1 mV<br>2 mV                          |   |
|                                | $V_{in} = 85 - 265 V_{AC}; I_{out} = 100 \text{ mA}$<br>$I_{out} = 500 \text{ mA}$<br>$I_{out} = 1.00 \text{ A}$  |   | 11 mV<br>24 mV<br>41 mV                       |
| Load Regulation                | $V_{in} = 85 V_{AC}; I_{out} = 120 \text{ mA} - 1.2 \text{ A}$<br>$V_{in} = 110 V_{AC}; I_{out} = 120 \text{ mA} - 1.2 \text{ A}$<br>$V_{in} = 230 V_{AC}; I_{out} = 120 \text{ mA} - 1.2 \text{ A}$<br>$V_{in} = 265 V_{AC}; I_{out} = 120 \text{ mA} - 1.2 \text{ A}$     | 12 mV<br>13 mV<br>12 mV<br>13 mV              |   |
|                                | $V_{in} = 85 V_{AC}; I_{out} = 100 \text{ mA} - 1.00 \text{ A}$<br>$V_{in} = 110 V_{AC}; I_{out} = 100 \text{ mA} - 1.00 \text{ A}$<br>$V_{in} = 230 V_{AC}; I_{out} = 100 \text{ mA} - 1.00 \text{ A}$<br>$V_{in} = 265 V_{AC}; I_{out} = 100 \text{ mA} - 1.00 \text{ A}$ |   | 58 mV<br>65 mV<br>71 mV<br>67 mV              |
| Output Ripple                  | $V_{in} = 110 V_{AC}; I_{out} = 1.2 \text{ A}$<br>$V_{in} = 230 V_{AC}; I_{out} = 1.2 \text{ A}$  | 86 mV <sub>p-p</sub><br>127 mV <sub>p-p</sub> |   |
|                                | $V_{in} = 110 V_{AC}; I_{out} = 1.00 \text{ A}$<br>$V_{in} = 230 V_{AC}; I_{out} = 1.00 \text{ A}$  |   | 80 mV <sub>p-p</sub><br>155 mV <sub>p-p</sub> |
| Efficiency                     | $V_{in} = 110 V_{AC}; I_{out} = 1.2 \text{ A}$<br>$V_{in} = 230 V_{AC}; I_{out} = 1.2 \text{ A}$  | 72.4%<br>69.6%                                |   |
|                                | $V_{in} = 110 V_{AC}; R_8 = 1.2 \Omega, I_{out} = 1.00 \text{ A}$<br>$V_{in} = 230 V_{AC}; R_8 = 1.2 \Omega, I_{out} = 1.00 \text{ A}$  |   | 54.6%<br>53.6%                                |
|                                | $V_{in} = 110 V_{AC}; R_8 = 0 \Omega, I_{out} = 1.00 \text{ A}$<br>$V_{in} = 230 V_{AC}; R_8 = 0 \Omega, I_{out} = 1.00 \text{ A}$  |   | 66.1%<br>63.3%                                |
| No Load Input Power            | $V_{in} = 110 V_{AC}; I_{out} = 0 \text{ A}$<br>$V_{in} = 230 V_{AC}; I_{out} = 0 \text{ A}$  | 100 mW<br>200 mW                              | 100 mW<br>200 mW                              |
| Standby Output Power           | $V_{in} = 110 V_{AC}; P_{in} = 1 \text{ W}$<br>$V_{in} = 230 V_{AC}; P_{in} = 1 \text{ W}$  | 680 mW<br>630 mW                              | 640 mW<br>540 mW                              |
| Short Circuit Load Input Power | $V_{in} = 110 V_{AC}; V_{out} = 0 \text{ V (Shorted)}$<br>$V_{in} = 230 V_{AC}; V_{out} = 0 \text{ V (Shorted)}$  | 400 mW<br>550 mW                              |   |
|                                | $V_{in} = 110 V_{AC}; R_8 = 1.2 \Omega, V_{out} = 0 \text{ V (Shorted)}$<br>$V_{in} = 230 V_{AC}; R_8 = 1.2 \Omega, V_{out} = 0 \text{ V (Shorted)}$  |   | 750 mW<br>900 mW                              |
|                                | $V_{in} = 110 V_{AC}; R_8 = 0 \Omega, V_{out} = 0 \text{ V (Shorted)}$<br>$V_{in} = 230 V_{AC}; R_8 = 0 \Omega, V_{out} = 0 \text{ V (Shorted)}$  |   | 700 mW<br>850 mW                              |

**Figure 29. Converter and Charger Test Data Summary**

# NCP1050, NCP1051, NCP1052, NCP1053, NCP1054, NCP1055

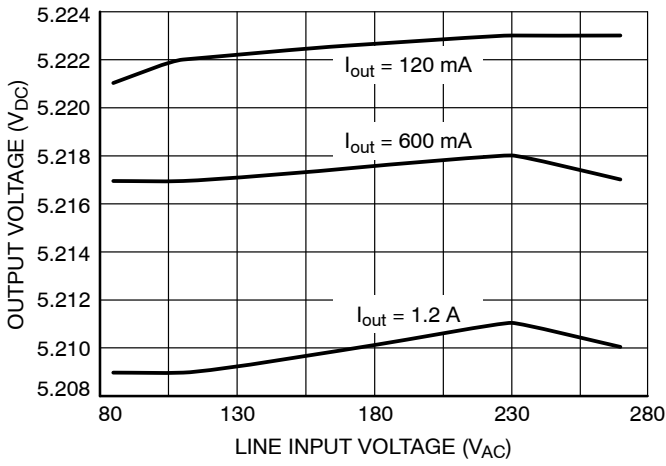

Figure 30. Converter Line Regulation

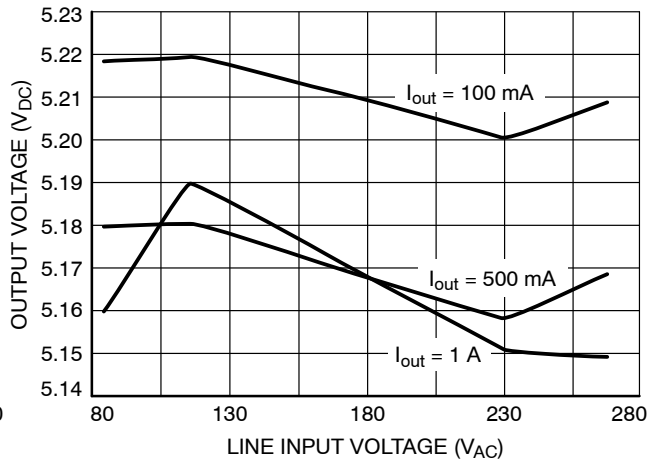

Figure 31. Charger Line Regulation

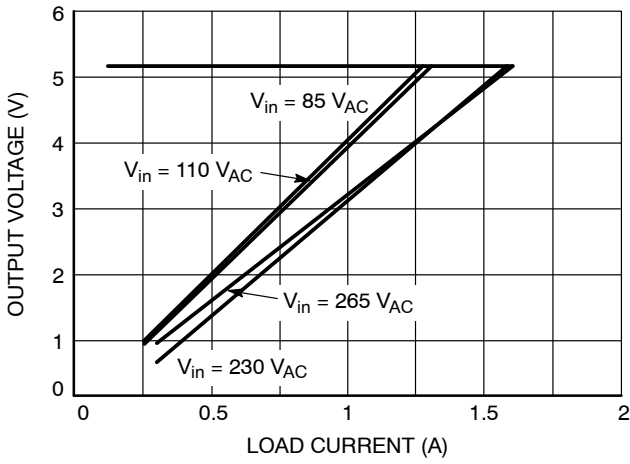

Figure 32. Converter Load Regulation

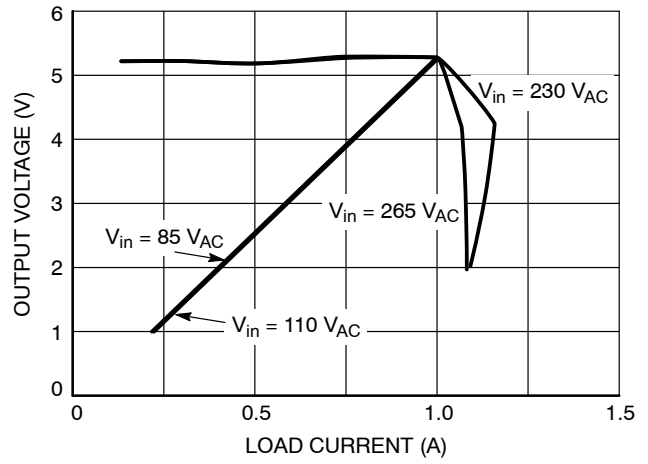

Figure 33. Charger Load Regulation

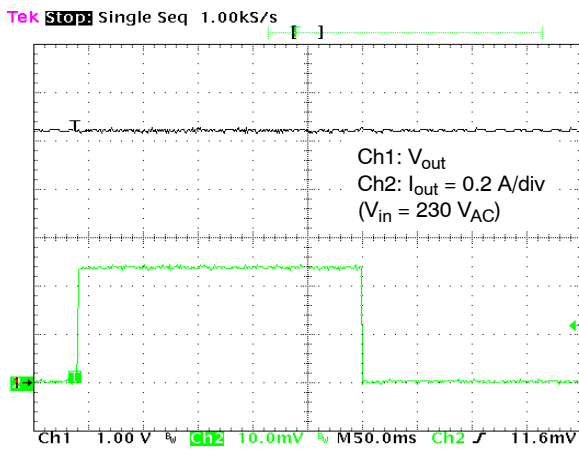

Figure 34. Converter Load Transient Response

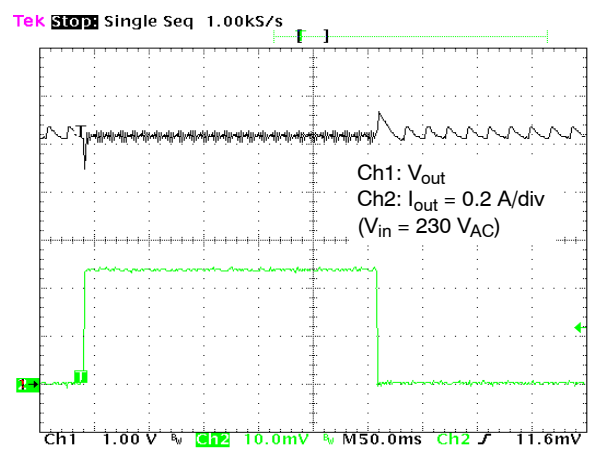

Figure 35. Charger Load Transient Response

# NCP1050, NCP1051, NCP1052, NCP1053, NCP1054, NCP1055



Figure 36. Converter Efficiency



Figure 37. Charger Efficiency

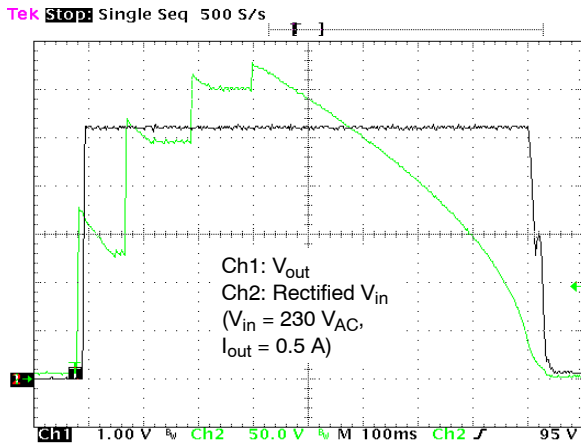

Figure 38. Converter On/Off Line Transient Response



Figure 39. Charger On/Off Line Transient Response

BOARD GRAPHICS



Top View



Bottom View

Figure 40. Printed Circuit Board and Component Layout

# NCP1050, NCP1051, NCP1052, NCP1053, NCP1054, NCP1055

## DEVICE ORDERING INFORMATION (Note 9)

| Device          | R <sub>DS(on)</sub><br>(Ω) | I <sub>pk</sub><br>(mA) | Package              | Shipping <sup>†</sup> |
|-----------------|----------------------------|-------------------------|----------------------|-----------------------|
| NCP1050P44G     | 30                         | 100                     | PDIP-8<br>(Pb-Free)  | 50 Units / Rail       |
| NCP1050P100G    | 30                         | 100                     | PDIP-8<br>(Pb-Free)  | 50 Units / Rail       |
| NCP1050P136G    | 30                         | 100                     | PDIP-8<br>(Pb-Free)  | 50 Units / Rail       |
| NCP1050ST44T3G  | 30                         | 100                     | SOT-223<br>(Pb-Free) | 4000 / Tape & Reel    |
| NCP1050ST100T3G | 30                         | 100                     | SOT-223<br>(Pb-Free) | 4000 / Tape & Reel    |
| NCP1050ST136T3G | 30                         | 100                     | SOT-223<br>(Pb-Free) | 4000 / Tape & Reel    |
| NCP1051P44G     | 30                         | 200                     | PDIP-8<br>(Pb-Free)  | 50 Units / Rail       |
| NCP1051P100G    | 30                         | 200                     | PDIP-8<br>(Pb-Free)  | 50 Units / Rail       |
| NCP1051P136G    | 30                         | 200                     | PDIP-8<br>(Pb-Free)  | 50 Units / Rail       |
| NCP1051ST44T3G  | 30                         | 200                     | SOT-223<br>(Pb-Free) | 4000 / Tape & Reel    |
| NCP1051ST100T3G | 30                         | 200                     | SOT-223<br>(Pb-Free) | 4000 / Tape & Reel    |
| NCP1051ST136T3G | 30                         | 200                     | SOT-223<br>(Pb-Free) | 4000 / Tape & Reel    |
| NCP1052P44G     | 30                         | 300                     | PDIP-8<br>(Pb-Free)  | 50 Units / Rail       |
| NCP1052P100G    | 30                         | 300                     | PDIP-8<br>(Pb-Free)  | 50 Units / Rail       |
| NCP1052P136G    | 30                         | 300                     | PDIP-8<br>(Pb-Free)  | 50 Units / Rail       |
| NCP1052ST44T3G  | 30                         | 300                     | SOT-223<br>(Pb-Free) | 4000 / Tape & Reel    |
| NCP1052ST100T3G | 30                         | 300                     | SOT-223<br>(Pb-Free) | 4000 / Tape & Reel    |
| NCP1052ST136T3G | 30                         | 300                     | SOT-223<br>(Pb-Free) | 4000 / Tape & Reel    |
| NCP1053P44G     | 15                         | 400                     | PDIP-8<br>(Pb-Free)  | 50 Units / Rail       |
| NCP1053P100G    | 15                         | 400                     | PDIP-8<br>(Pb-Free)  | 50 Units / Rail       |
| NCP1053P136G    | 15                         | 400                     | PDIP-8<br>(Pb-Free)  | 50 Units / Rail       |
| NCP1053ST44T3G  | 15                         | 400                     | SOT-223<br>(Pb-Free) | 4000 / Tape & Reel    |
| NCP1053ST100T3G | 15                         | 400                     | SOT-223<br>(Pb-Free) | 4000 / Tape & Reel    |
| NCP1053ST136T3G | 15                         | 400                     | SOT-223<br>(Pb-Free) | 4000 / Tape & Reel    |

<sup>†</sup>For information on tape and reel specifications, including part orientation and tape sizes, please refer to our Tape and Reel Packaging Specifications Brochure, BRD8011/D.

9. Consult factory for additional optocoupler fail-safe latching, frequency, current limit and line input options.

## NCP1050, NCP1051, NCP1052, NCP1053, NCP1054, NCP1055

### DEVICE ORDERING INFORMATION (Note 9)

| Device          | $R_{DS(on)}$<br>( $\Omega$ ) | $I_{pk}$<br>(mA) | Package              | Shipping <sup>†</sup> |
|-----------------|------------------------------|------------------|----------------------|-----------------------|
| NCP1054P44G     | 15                           | 530              | PDIP-8<br>(Pb-Free)  | 50 Units / Rail       |
| NCP1054P100G    | 15                           | 530              | PDIP-8<br>(Pb-Free)  | 50 Units / Rail       |
| NCP1054P136G    | 15                           | 530              | PDIP-8<br>(Pb-Free)  | 50 Units / Rail       |
| NCP1054ST44T3G  | 15                           | 530              | SOT-223<br>(Pb-Free) | 4000 / Tape & Reel    |
| NCP1054ST100T3G | 15                           | 530              | SOT-223<br>(Pb-Free) | 4000 / Tape & Reel    |
| NCP1054ST136T3G | 15                           | 530              | SOT-223<br>(Pb-Free) | 4000 / Tape & Reel    |
| NCP1055P44G     | 15                           | 680              | PDIP-8<br>(Pb-Free)  | 50 Units / Rail       |
| NCP1055P100G    | 15                           | 680              | PDIP-8<br>(Pb-Free)  | 50 Units / Rail       |
| NCP1055P136G    | 15                           | 680              | PDIP-8<br>(Pb-Free)  | 50 Units / Rail       |
| NCP1055ST44T3G  | 15                           | 680              | SOT-223<br>(Pb-Free) | 4000 / Tape & Reel    |
| NCP1055ST100T3G | 15                           | 680              | SOT-223<br>(Pb-Free) | 4000 / Tape & Reel    |
| NCP1055ST136T3G | 15                           | 680              | SOT-223<br>(Pb-Free) | 4000 / Tape & Reel    |

<sup>†</sup>For information on tape and reel specifications, including part orientation and tape sizes, please refer to our Tape and Reel Packaging Specifications Brochure, BRD8011/D.

9. Consult factory for additional optocoupler fail-safe latching, frequency, current limit and line input options.

PACKAGE DIMENSIONS

PDIP-8  
P SUFFIX  
CASE 626A-01  
ISSUE O

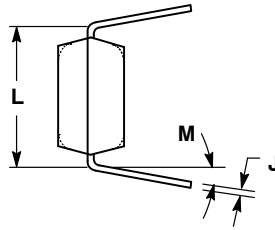
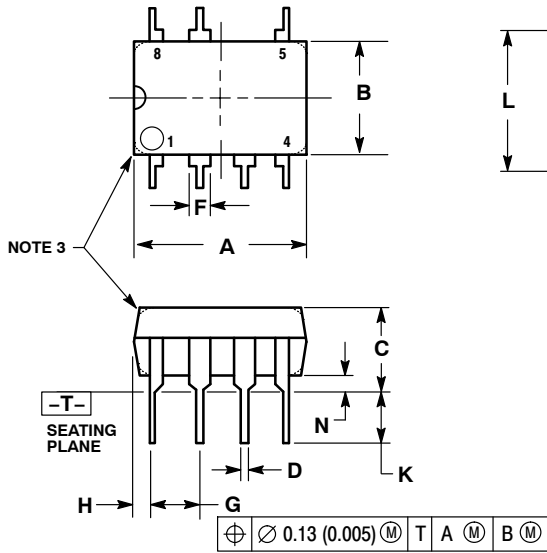

NOTES:

1. DIMENSIONING AND TOLERANCING PER ANSI Y14.5M, 1982.
2. CONTROLLING DIMENSION: MILLIMETER.
3. PACKAGE CONTOUR OPTIONAL (ROUND OR SQUARE CORNERS).
4. DIMENSION L TO CENTER OF LEAD WHEN FORMED PARALLEL.
5. DIMENSIONS A AND B ARE DATUMS.

| DIM | MILLIMETERS |       | INCHES    |       |
|-----|-------------|-------|-----------|-------|
|     | MIN         | MAX   | MIN       | MAX   |
| A   | 9.40        | 10.16 | 0.370     | 0.400 |
| B   | 6.10        | 6.60  | 0.240     | 0.260 |
| C   | 3.94        | 4.45  | 0.155     | 0.175 |
| D   | 0.38        | 0.51  | 0.015     | 0.020 |
| F   | 1.02        | 1.78  | 0.040     | 0.070 |
| G   | 2.54 BSC    |       | 0.100 BSC |       |
| H   | 0.76        | 1.27  | 0.030     | 0.050 |
| J   | 0.20        | 0.30  | 0.008     | 0.012 |
| K   | 2.92        | 3.43  | 0.115     | 0.135 |
| L   | 7.62 BSC    |       | 0.300 BSC |       |
| M   | ---         | 10°   | ---       | 10°   |
| N   | 0.76        | 1.01  | 0.030     | 0.040 |



# NCP1050, NCP1051, NCP1052, NCP1053, NCP1054, NCP1055

SOT-223 (TO-261)  
CASE 318E-04  
ISSUE M



NOTES:  
C. DIMENSIONING AND TOLERANCING PER ANSI Y14.5M, 1982.  
D. CONTROLLING DIMENSION: INCH.

| DIM   | MILLIMETERS |      |      | INCHES |       |       |
|-------|-------------|------|------|--------|-------|-------|
|       | MIN         | NOM  | MAX  | MIN    | NOM   | MAX   |
| A     | 1.50        | 1.63 | 1.75 | 0.060  | 0.064 | 0.068 |
| A1    | 0.02        | 0.06 | 0.10 | 0.001  | 0.002 | 0.004 |
| b     | 0.60        | 0.75 | 0.89 | 0.024  | 0.030 | 0.035 |
| b1    | 2.90        | 3.06 | 3.20 | 0.115  | 0.121 | 0.126 |
| c     | 0.24        | 0.29 | 0.35 | 0.009  | 0.012 | 0.014 |
| D     | 6.30        | 6.50 | 6.70 | 0.249  | 0.256 | 0.263 |
| E     | 3.30        | 3.50 | 3.70 | 0.130  | 0.138 | 0.145 |
| e     | 2.20        | 2.30 | 2.40 | 0.087  | 0.091 | 0.094 |
| e1    | 0.85        | 0.94 | 1.05 | 0.033  | 0.037 | 0.041 |
| L1    | 1.50        | 1.75 | 2.00 | 0.060  | 0.069 | 0.078 |
| HE    | 6.70        | 7.00 | 7.30 | 0.264  | 0.276 | 0.287 |
| theta | 0°          | -    | 10°  | 0°     | -     | 10°   |

## SOLDERING FOOTPRINT\*



\*For additional information on our Pb-Free strategy and soldering details, please download the ON Semiconductor Soldering and Mounting Techniques Reference Manual, SOLDERRM/D.

SENSEFET is a trademark of Semiconductor Components Industries, LLC (SCILLC)

ON Semiconductor and are registered trademarks of Semiconductor Components Industries, LLC (SCILLC). SCILLC reserves the right to make changes without further notice to any products herein. SCILLC makes no warranty, representation or guarantee regarding the suitability of its products for any particular purpose, nor does SCILLC assume any liability arising out of the application or use of any product or circuit, and specifically disclaims any and all liability, including without limitation special, consequential or incidental damages. "Typical" parameters which may be provided in SCILLC data sheets and/or specifications can and do vary in different applications and actual performance may vary over time. All operating parameters, including "Typicals" must be validated for each customer application by customer's technical experts. SCILLC does not convey any license under its patent rights nor the rights of others. SCILLC products are not designed, intended, or authorized for use as components in systems intended for surgical implant into the body, or other applications intended to support or sustain life, or for any other application in which the failure of the SCILLC product could create a situation where personal injury or death may occur. Should Buyer purchase or use SCILLC products for any such unintended or unauthorized application, Buyer shall indemnify and hold SCILLC and its officers, employees, subsidiaries, affiliates, and distributors harmless against all claims, costs, damages, and expenses, and reasonable attorney fees arising out of, directly or indirectly, any claim of personal injury or death associated with such unintended or unauthorized use, even if such claim alleges that SCILLC was negligent regarding the design or manufacture of the part. SCILLC is an Equal Opportunity/Affirmative Action Employer. This literature is subject to all applicable copyright laws and is not for resale in any manner.

## PUBLICATION ORDERING INFORMATION

LITERATURE FULFILLMENT:  
Literature Distribution Center for ON Semiconductor  
P.O. Box 5163, Denver, Colorado 80217 USA  
Phone: 303-675-2175 or 800-344-3860 Toll Free USA/Canada  
Fax: 303-675-2176 or 800-344-3867 Toll Free USA/Canada  
Email: orderlit@onsemi.com

N. American Technical Support: 800-282-9855 Toll Free  
USA/Canada  
Europe, Middle East and Africa Technical Support:  
Phone: 421 33 790 2910  
Japan Customer Focus Center  
Phone: 81-3-5773-3850

ON Semiconductor Website: [www.onsemi.com](http://www.onsemi.com)  
Order Literature: <http://www.onsemi.com/orderlit>  
For additional information, please contact your local Sales Representative



Компания «ЭлектроПласт» предлагает заключение долгосрочных отношений при поставках импортных электронных компонентов на взаимовыгодных условиях!

Наши преимущества:

- Оперативные поставки широкого спектра электронных компонентов отечественного и импортного производства напрямую от производителей и с крупнейших мировых складов;
- Поставка более 17-ти миллионов наименований электронных компонентов;
- Поставка сложных, дефицитных, либо снятых с производства позиций;
- Оперативные сроки поставки под заказ (от 5 рабочих дней);
- Экспресс доставка в любую точку России;
- Техническая поддержка проекта, помощь в подборе аналогов, поставка прототипов;
- Система менеджмента качества сертифицирована по Международному стандарту ISO 9001;
- Лицензия ФСБ на осуществление работ с использованием сведений, составляющих государственную тайну;
- Поставка специализированных компонентов (Xilinx, Altera, Analog Devices, Intersil, Interpoint, Microsemi, Aeroflex, Peregrine, Syfer, Eurofarad, Texas Instrument, Miteq, Cobham, E2V, MA-COM, Hittite, Mini-Circuits, General Dynamics и др.);

Помимо этого, одним из направлений компании «ЭлектроПласт» является направление «Источники питания». Мы предлагаем Вам помощь Конструкторского отдела:

- Подбор оптимального решения, техническое обоснование при выборе компонента;
- Подбор аналогов;
- Консультации по применению компонента;
- Поставка образцов и прототипов;
- Техническая поддержка проекта;
- Защита от снятия компонента с производства.



#### Как с нами связаться

**Телефон:** 8 (812) 309 58 32 (многоканальный)

**Факс:** 8 (812) 320-02-42

**Электронная почта:** [org@eplast1.ru](mailto:org@eplast1.ru)

**Адрес:** 198099, г. Санкт-Петербург, ул. Калинина, дом 2, корпус 4, литера А.