



**Features**

- P<sub>OUT</sub> = 27dBm, 5V < 3% Dynamic EVM
- 33dB Typical Gain
- High PAE
- Integrated Input and Output 50Ω Match
- Integrated Power Detector
- Integrated Harmonic Filtering

**Applications**

- WiFi 802.11 b/g/n Applications
- Consumer Premise Equipment (CPE)
- Picocell; Femtocell
- Data Cards and Terminals
- Wireless Access Points, Gateways, Routers and Set Top Box Applications

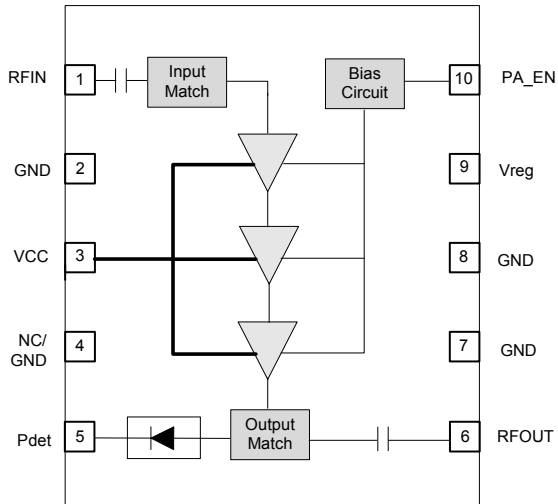

Functional Block Diagram

**Product Description**

RFPA5200 is a three-stage power amplifier (PA) designed for 802.11b/g/n applications. The integrated input and output 50Ω match eliminates the need for any external matching components and greatly reduces layout area, bill of materials (BOM) and manufacturability cost in the customer application. The RFPA5200 is manufactured on an advanced InGaP heterojunction bipolar transistor (HBT) process. This PA is capable of achieving linear power up to 27dBm with an EVM < 3% while maintaining excellent power added efficiency (PAE). The device is provided in a 4mm x 4mm x 1mm, 10-pin laminate package and it meets or exceeds the power requirements of IEEE802.11b/g/n WiFi RF systems.

**Ordering Information**

RFPA5200SB	5-Piece bag
RFPA5200SR	100-Piece reel
RFPA5200TR7	2500-Piece reel
RFPA5200SQ	25-Piece bag
RFPA5200PCK-410	RFPA5200 Eval board with 5-piece bag
RFPA5200PCK-411	RFPA5200 Balanced eval board with 5-piece bag

### Absolute Maximum Ratings

Parameter	Rating	Unit
Supply Voltage (RF Applied)	-0.5 to +5.5	V
Supply Voltage (No RF Applied)	-0.5 to +6.0	V
DC Supply Current	1000	mA
Input RF Power with 50Ω Output Load	10	dBm
Maximum VSWR with no damage	10:1	
Operating Ambient Temperature	-40 to +85	°C
Storage Temperature	-40 to +150	°C
Moisture Sensitivity	MSL3	



**Caution!** ESD sensitive device.

Exceeding any one or a combination of the Absolute Maximum Rating conditions may cause permanent damage to the device. Extended application of Absolute Maximum Rating conditions to the device may reduce device reliability. Specified typical performance or functional operation of the device under Absolute Maximum Rating conditions is not implied.

The information in this publication is believed to be accurate and reliable. However, no responsibility is assumed by RF Micro Devices, Inc. ("RFMD") for its use, nor for any infringement of patents, or other rights of third parties, resulting from its use. No license is granted by implication or otherwise under any patent or patent rights of RFMD. RFMD reserves the right to change component circuitry, recommended application circuitry and specifications at any time without prior notice.

Parameter	Specification			Unit	Condition
	Min.	Typ.	Max.		
<b>Typical Conditions</b>					$V_{CC} = 5.0V$ , $V_{REG} = 2.9V$ , temperature = 25 °C, MSC7 HT20 and HT40, frequency = 2412MHz to 2484MHz unless otherwise noted.
Tx Performance - 11g/n					Compliance with standard 802.11g/n
Frequency	2412		2484	MHz	
802.11n Output Power		26.5		dBm	
Dynamic EVM (11n)		2.5	3	%	
802.11g Output Power		27		dBm	OFDM 64QAM 54Mbps
Dynamic EVM (11g)		2.5	3	%	
Second Harmonic			-20	dBm/MHz	At rated $P_{OUT}$
Third Harmonic			-43	dBm/MHz	
Gain	31	33		dB	
	28	33	38	dB	Temperature -40 °C to +85 °C
Power Detect Range	0.1		2.1	V	$P_{OUT} = 0dBm$ to 27dBm
Power Detect Voltage	1.3	1.6	2.1	V	At rated $P_{OUT}$
Input Return Loss - Tx input pin	10	15		dB	In specified frequency band
Output Return Loss at ANT pin	5	10		dB	
Operating Current		470	520	mA	At rated $P_{OUT}$
Quiescent Current		150	185	mA	$V_{CC} = 5.0$ , $V_{CONTROL} = 3V$ and RF = OFF
PAE (Power Added Efficiency)		21		%	At rated $P_{OUT}$
$P_{DOWN}$ Current - $V_{CC}$ Supply			10	mA	$PA\_EN = 0V$ , $V_{CC} = 5V$ , $V_{REG} = 2.9V$ (includes $I_{REG}$ )
$I_{REG}$		5	10	mA	
$V_{CC}$ Leakage Current			10	μA	$V_{CC} = 5V$ , $V_{REG} = 0V$ , $PA\_EN = 0V$
Operating Power Supply - $V_{CC}$		5	5.25	V	
$V_{REG}$ Voltage (at $V_{REG}$ pin of Eval board)	2.85	2.90	3.3	V	
Turn-on time from setting of $V_{REGS}$		300		ns	Output stable to within 90% of final gain
Turn-off time from setting of $V_{REGS}$		400		ns	
Stability	4:1				No spurs above -47dBm
CW P1dB		33		dBm	

Parameter	Specification			Unit	Condition
	Min.	Typ.	Max.		
<b>Typical Conditions (continued)</b>					
Tx Performance - Generic					
ESD					
Human Body Model		1000		V	All pins
Charge Device Model		1000		V	All pins
Thermal Resistance					
$R_{TH\_J}$		38		°C/W	$V_{CC}=5V, P_{OUT} = 27dBm, 64QAM 54Mbps, \text{duty cycle} = 100\%, \text{heated stage} = 85^\circ C$
$T_{J-MAX}$			175	°C	

### Pin Names and Descriptions

Pin	Name	Description
1	RFIN	RF input, is internally matched to 50Ω. DC Blocked
2	GND	Ground connection.
3	VCC	This pin is connected internally to the collectors of RF device. To achieve specified performance, the layout of the pin should match the Recommended Land Pattern
4	NC	No Connection internal, Can be grounded or left open
5	PDET	Power detector provides an output voltage proportional to the RF output power level.
6	RFOUT	RF output, is internally matched to 50Ω. DC Blocked
7	GND	Ground connection.
8	GND	Ground connection.
9	VREG	PA bias voltage. This pin requires regulated supply for best performance.
10	PA_EN	PA Enable pin, Apply $< 0.6V_{DC}$ to turn PA off. Apply $1.75V_{DC}$ to $5V_{DC}$ to enable the PA.
Pkg Base	GND	Ground connection. The back side of the package should be connected to the ground plane through as short connection as possible, e.g., PCB vias under the device are recommended.

## Pin Out



**Package Drawing**

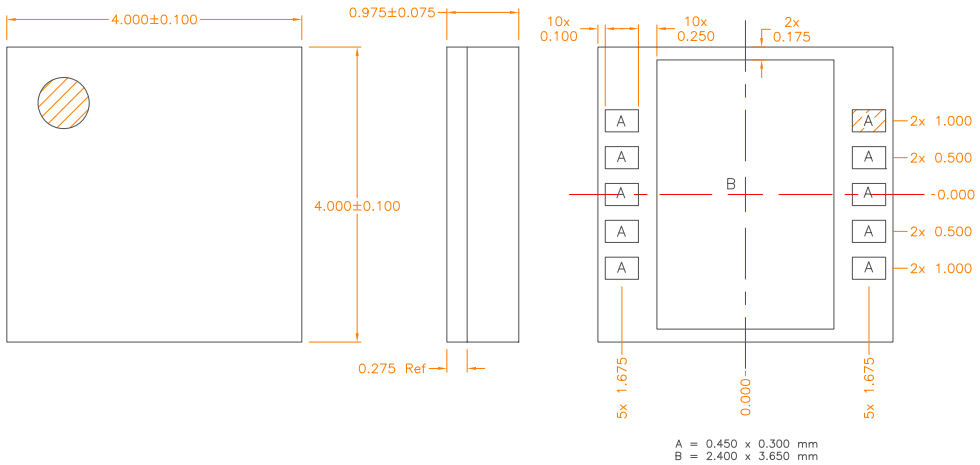

Notes:

- 1. Shaded area represents Pin 1 location.

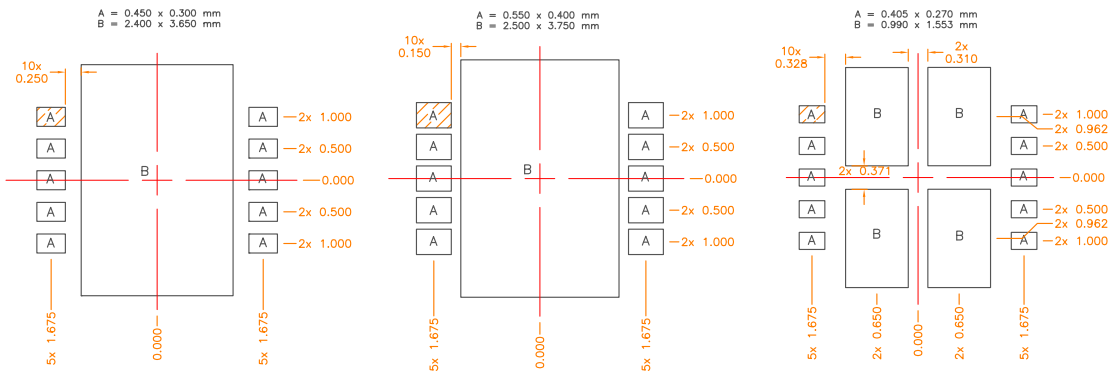

PCB Metal Land Pattern

PCB Solder Mask Pattern

PCB Stencil Pattern

Notes:

- 1. Shaded area represents Pin 1 location.

## Applications Schematic

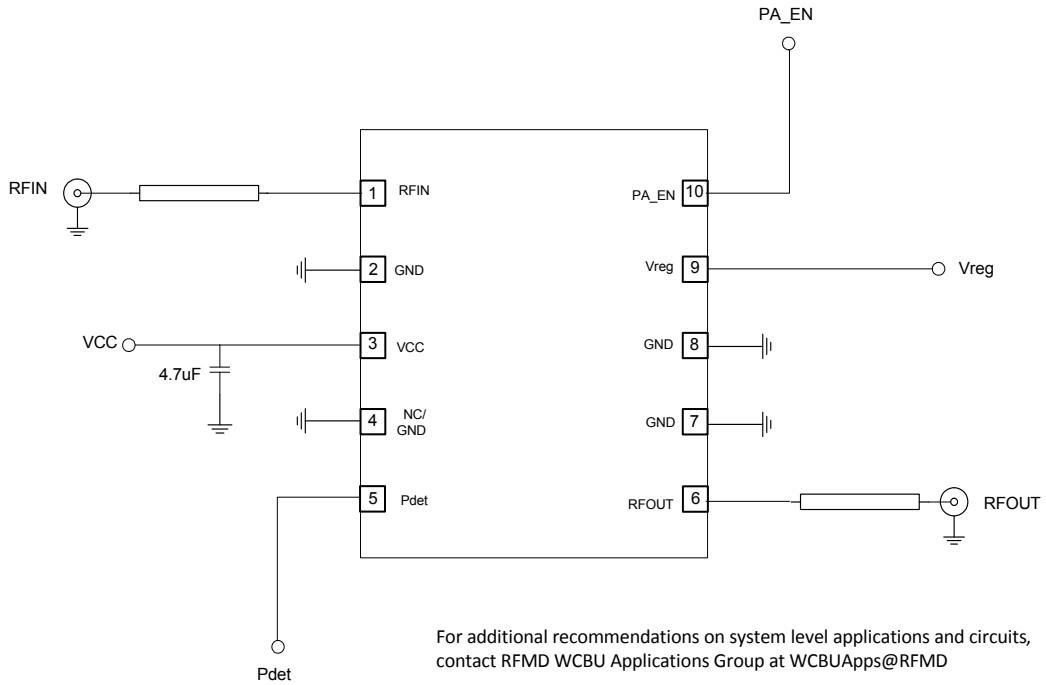

**RFPA5200 Performance Plots**

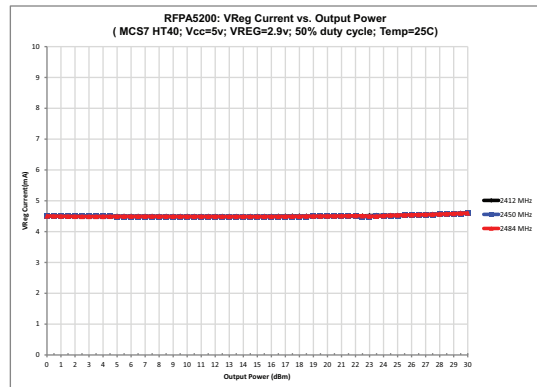
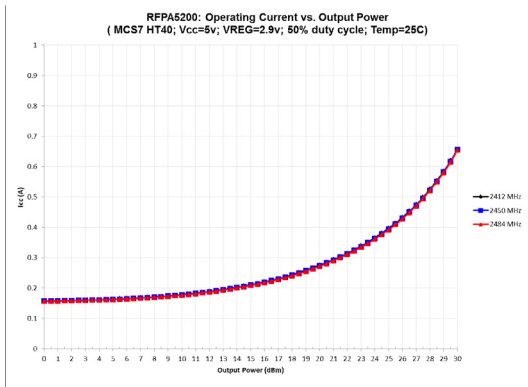
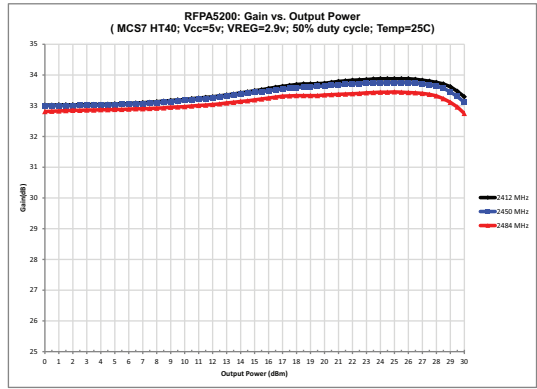
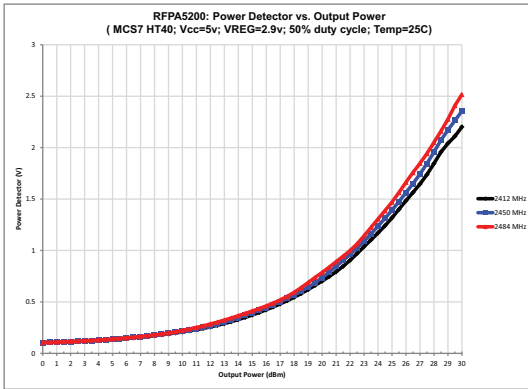
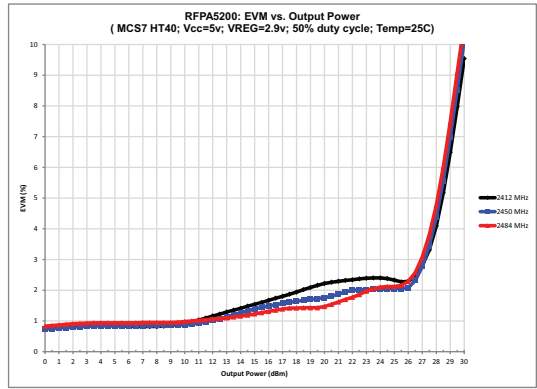
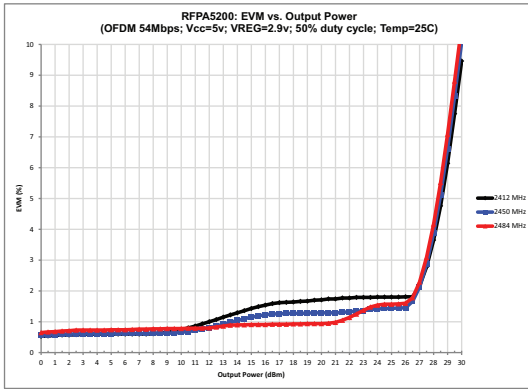

## RFPA5200 Performance Plots (continued)

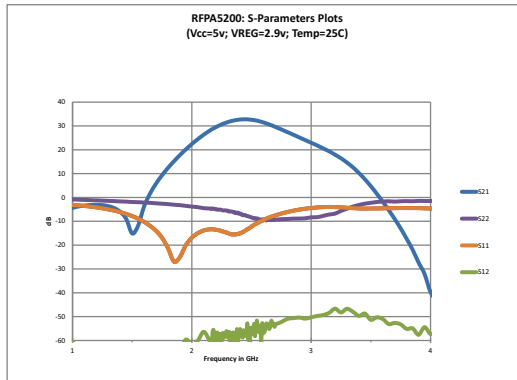
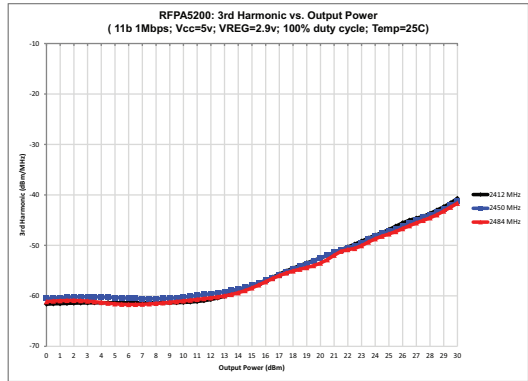
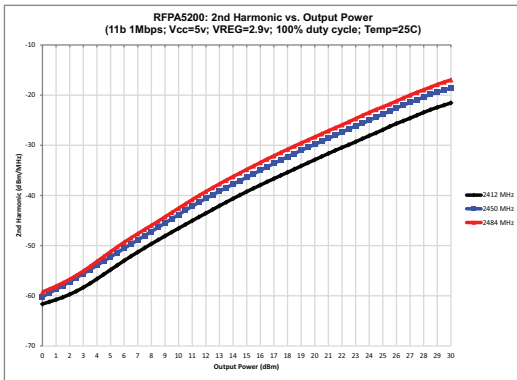





Компания «ЭлектроПласт» предлагает заключение долгосрочных отношений при поставках импортных электронных компонентов на взаимовыгодных условиях!

Наши преимущества:

- Оперативные поставки широкого спектра электронных компонентов отечественного и импортного производства напрямую от производителей и с крупнейших мировых складов;
- Поставка более 17-ти миллионов наименований электронных компонентов;
- Поставка сложных, дефицитных, либо снятых с производства позиций;
- Оперативные сроки поставки под заказ (от 5 рабочих дней);
- Экспресс доставка в любую точку России;
- Техническая поддержка проекта, помощь в подборе аналогов, поставка прототипов;
- Система менеджмента качества сертифицирована по Международному стандарту ISO 9001;
- Лицензия ФСБ на осуществление работ с использованием сведений, составляющих государственную тайну;
- Поставка специализированных компонентов (Xilinx, Altera, Analog Devices, Intersil, Interpoint, Microsemi, Aeroflex, Peregrine, Syfer, Eurofarad, Texas Instrument, Miteq, Cobham, E2V, MA-COM, Hittite, Mini-Circuits, General Dynamics и др.);

Помимо этого, одним из направлений компании «ЭлектроПласт» является направление «Источники питания». Мы предлагаем Вам помощь Конструкторского отдела:

- Подбор оптимального решения, техническое обоснование при выборе компонента;
- Подбор аналогов;
- Консультации по применению компонента;
- Поставка образцов и прототипов;
- Техническая поддержка проекта;
- Защита от снятия компонента с производства.



#### Как с нами связаться

**Телефон:** 8 (812) 309 58 32 (многоканальный)

**Факс:** 8 (812) 320-02-42

**Электронная почта:** [org@eplast1.ru](mailto:org@eplast1.ru)

**Адрес:** 198099, г. Санкт-Петербург, ул. Калинина, дом 2, корпус 4, литера А.