

Series: Jaguar

Description: 3G/4G LTE 2xMiMo Vehicular Antenna

PART NUMBER: W1919

### Features:

- 698-960/1710-3800MHz
- Extremely compact size LTE MiMo Antenna
  - 78.2 x 78.2 x 30.3mm
- Standard cable length 3m with SMA Male connectors
- IP67
- Mounting with adhesive tape

### Applications:

- Indoor and outdoor use
- 2G/3G/4G radios
- 2xLTE MiMo
- 3G Main + Diversity
- Vehicular, Telematics, Transportation
- Cellular access points



All dimensions are in mm / inches

Issue: 1748P

In the effort to improve our products, we reserve the right to make changes judged to be necessary.

CONFIDENTIAL AND PROPRIETARY INFORMATION

This document contains confidential and proprietary information of Pulse Electronics, Inc. (Pulse) and is protected by copyright, trade secret and other state and federal laws. Its receipt or possession does not convey any rights to reproduce, disclose its contents, or to manufacture, use or sell anything it may describe. Reproduction, disclosure or use without specific written authorization of Pulse is strictly forbidden.

For more information:

Pulse Worldwide Headquarters  
15255 Innovation Drive #100  
San Diego, CA 92128  
USA  
Tel: 1-858-674-8100

Pulse/Larsen Antennas  
18110 SE 34<sup>th</sup> St Bldg 2 Suite 250  
Vancouver, WA 98683  
USA  
Tel: 1-360-944-7551

Europe Headquarters  
Pulse GmbH & Do, KG  
Zeppelinstrasse 15  
Herrenberg, Germany  
Tel: 49 7032 7806 0

Pulse (Suzhou) Wireless Products Co, Inc.  
99 Huo Ju Road(#29 Bldg,4<sup>th</sup> Phase  
Suzhou New District  
Jiangsu Province, Suzhou 215009 PR China  
Tel: 86 512 6807 9998

Preliminary



Series: Jaguar

Description: 3G/4G LTE 2xMiMo Vehicular Antenna

PART NUMBER: W1919

### ELECTRICAL SPECIFICATIONS

Frequency	698-960 MHz / 1710-2690MHz/3400-3800MHz
Nominal Impedance	50 Ω
Return Loss	-10 dB
Isolation	-15 dB
Radiation Pattern	Omni
Gain	-0.42dBi @698-960MHz 1.77dBi @1710-2690MHz 1.76dBi @3400-3800MHz
Polarization	Vertical
Power Withstanding	5W

### MECHANICAL SPECIFICATIONS

Overall Length	78.2mm
Weight	142g
Antenna Color / Material	Black, PC
Connector type	SMA Male
Cable type	RG174, Black
Cable length	3000mm

### ENVIRONMENTAL SPECIFICATIONS

Operating Temperature	-40 ~ +85° C
Storage Temperature	-40 ~ +85° C
Ingress Protection	IP67
RoHS Compliant	Yes

Issue: 1748P

In the effort to improve our products, we reserve the right to make changes judged to be necessary.

CONFIDENTIAL AND PROPRIETARY INFORMATION

This document contains confidential and proprietary information of Pulse Electronics, Inc. (Pulse) and is protected by copyright, trade secret and other state and federal laws. Its receipt or possession does not convey any rights to reproduce, disclose its contents, or to manufacture, use or sell anything it may describe. Reproduction, disclosure or use without specific written authorization of Pulse is strictly forbidden.

Preliminary



Description: 3G/4G LTE 2xMiMo Vehicular Antenna

Series: Jaguar

PART NUMBER: W1919

MECHANICAL DRAWING

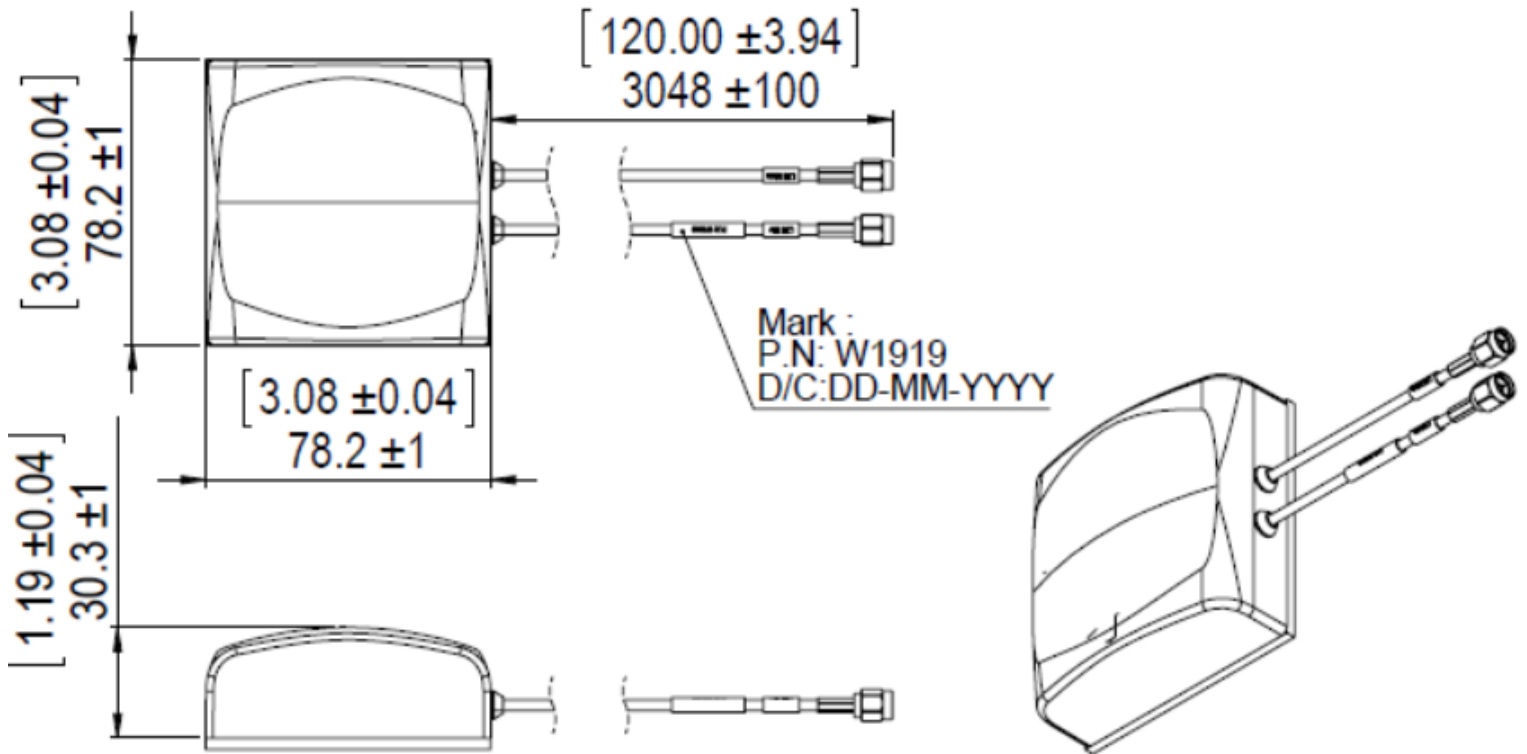

Part NO.	CABLE LENGTH	LTE Main Cable	LTE Div Cable	APPEARANCE COLOR	MOUNTING
W1919	3M(118.11")	RG174+SMA Male	RG174+SMA Male	Black	Adhesive Mount

Issue: 1748P

In the effort to improve our products, we reserve the right to make changes judged to be necessary.

CONFIDENTIAL AND PROPRIETARY INFORMATION

This document contains confidential and proprietary information of Pulse Electronics, Inc. (Pulse) and is protected by copyright, trade secret and other state and federal laws. Its receipt or possession does not convey any rights to reproduce, disclose its contents, or to manufacture, use or sell anything it may describe. Reproduction, disclosure or use without specific written authorization of Pulse is strictly forbidden.

Preliminary



Description: 3G/4G LTE 2xMiMo Vehicular Antenna

Series: Jaguar

PART NUMBER: W1919

CHARTS

Return Loss

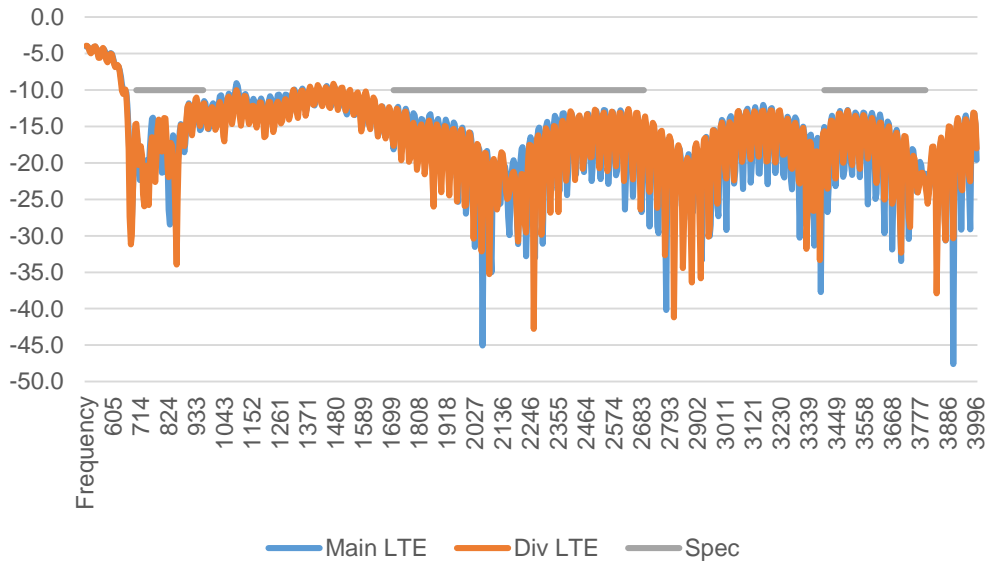

Isolation

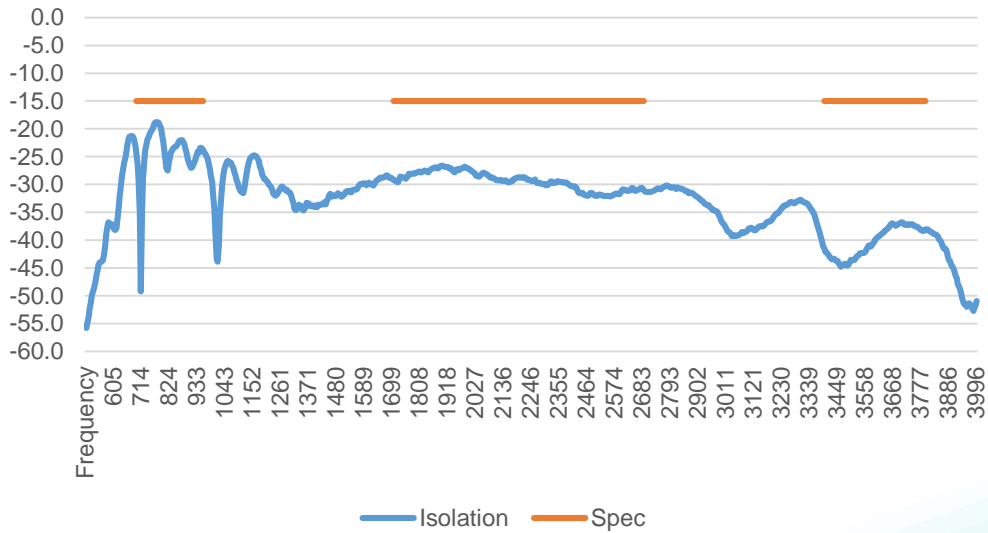

Note : Antenna measured with 10ft cable

Issue: 1748P

In the effort to improve our products, we reserve the right to make changes judged to be necessary.

CONFIDENTIAL AND PROPRIETARY INFORMATION

This document contains confidential and proprietary information of Pulse Electronics, Inc. (Pulse) and is protected by copyright, trade secret and other state and federal laws. Its receipt or possession does not convey any rights to reproduce, disclose its contents, or to manufacture, use or sell anything it may describe. Reproduction, disclosure or use without specific written authorization of Pulse is strictly forbidden.

Preliminary



Description: 3G/4G LTE 2xMiMo Vehicular Antenna

Series: Jaguar

PART NUMBER: W1919

CHARTS

Efficiency(%)

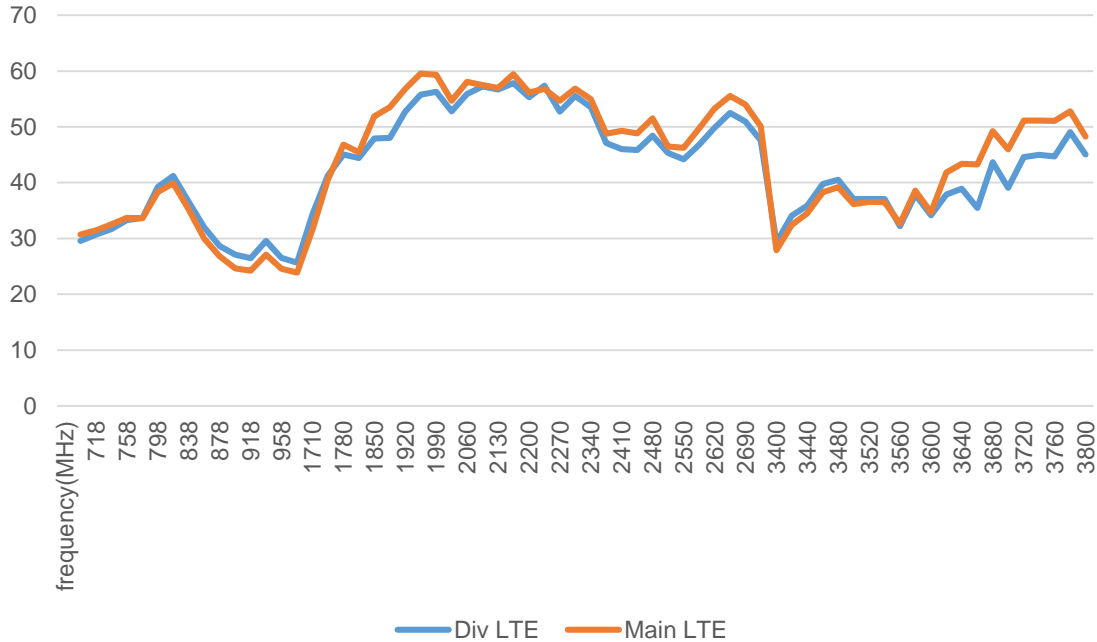

Peak Gain(dBi)

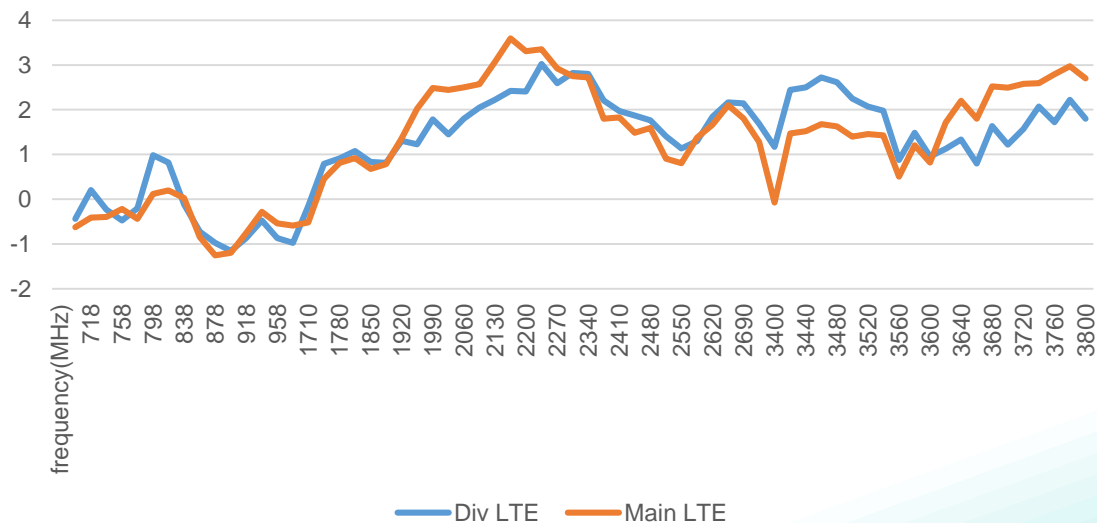

Note : Antenna measured in free space with 150mm cable

Issue: 1748P

In the effort to improve our products, we reserve the right to make changes judged to be necessary.  
CONFIDENTIAL AND PROPRIETARY INFORMATION

This document contains confidential and proprietary information of Pulse Electronics, Inc. (Pulse) and is protected by copyright, trade secret and other state and federal laws. Its receipt or possession does not convey any rights to reproduce, disclose its contents, or to manufacture, use or sell anything it may describe. Reproduction, disclosure or use without specific written authorization of Pulse is strictly forbidden.

Preliminary



Description: 3G/4G LTE 2xMiMo Vehicular Antenna

Series: Jaguar

PART NUMBER: W1919

CHARTS

Gain Plots (Main LTE)

XY Plane

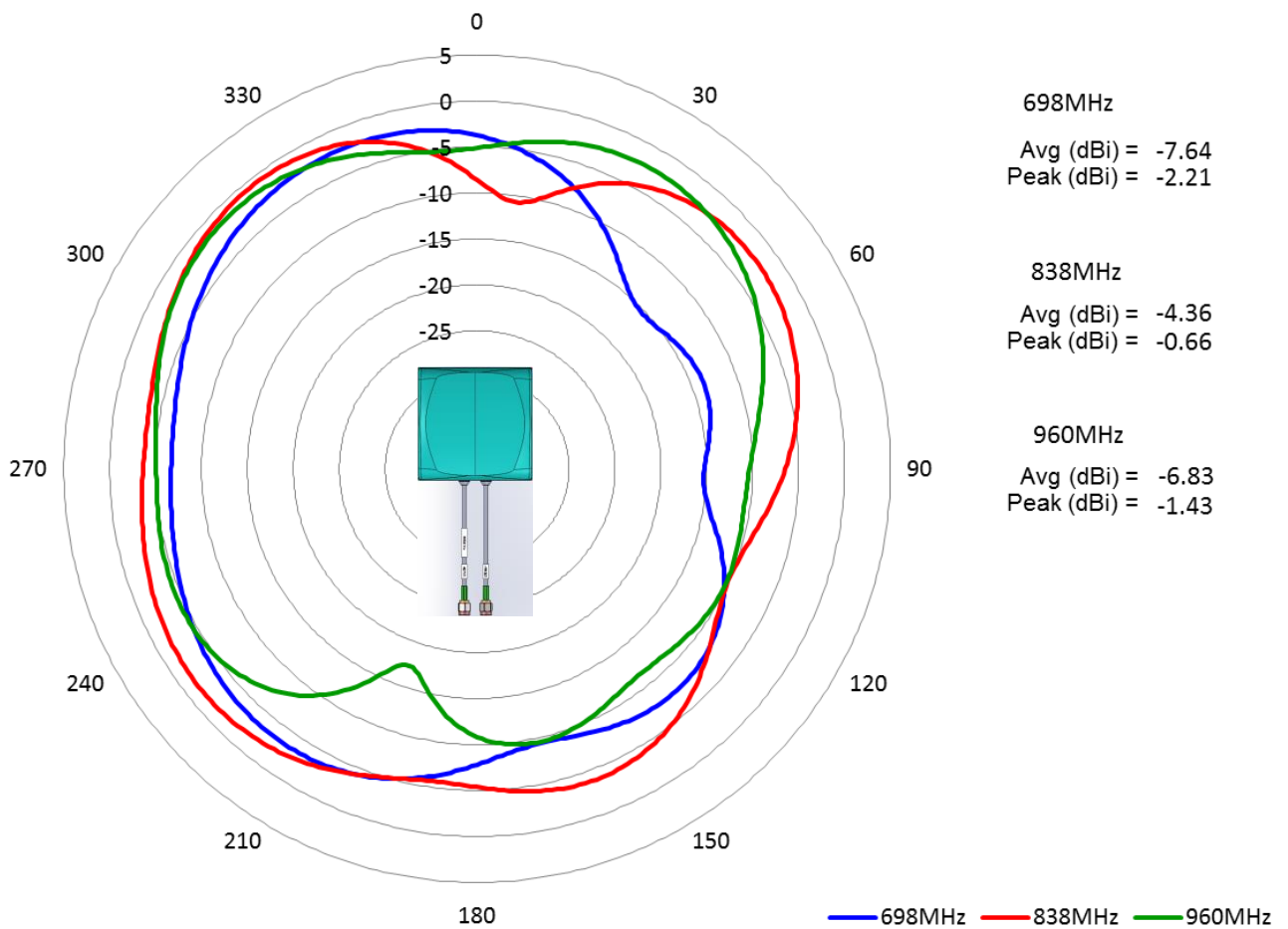

Note : Antenna measured in free space with 150mm cable

Issue: 1748P

In the effort to improve our products, we reserve the right to make changes judged to be necessary.

CONFIDENTIAL AND PROPRIETARY INFORMATION

This document contains confidential and proprietary information of Pulse Electronics, Inc. (Pulse) and is protected by copyright, trade secret and other state and federal laws. Its receipt or possession does not convey any rights to reproduce, disclose its contents, or to manufacture, use or sell anything it may describe. Reproduction, disclosure or use without specific written authorization of Pulse is strictly forbidden.

Preliminary



Description: 3G/4G LTE 2xMiMo Vehicular Antenna

Series: Jaguar

PART NUMBER: W1919

CHARTS

Gain Plots (Main LTE)

ZX Plane

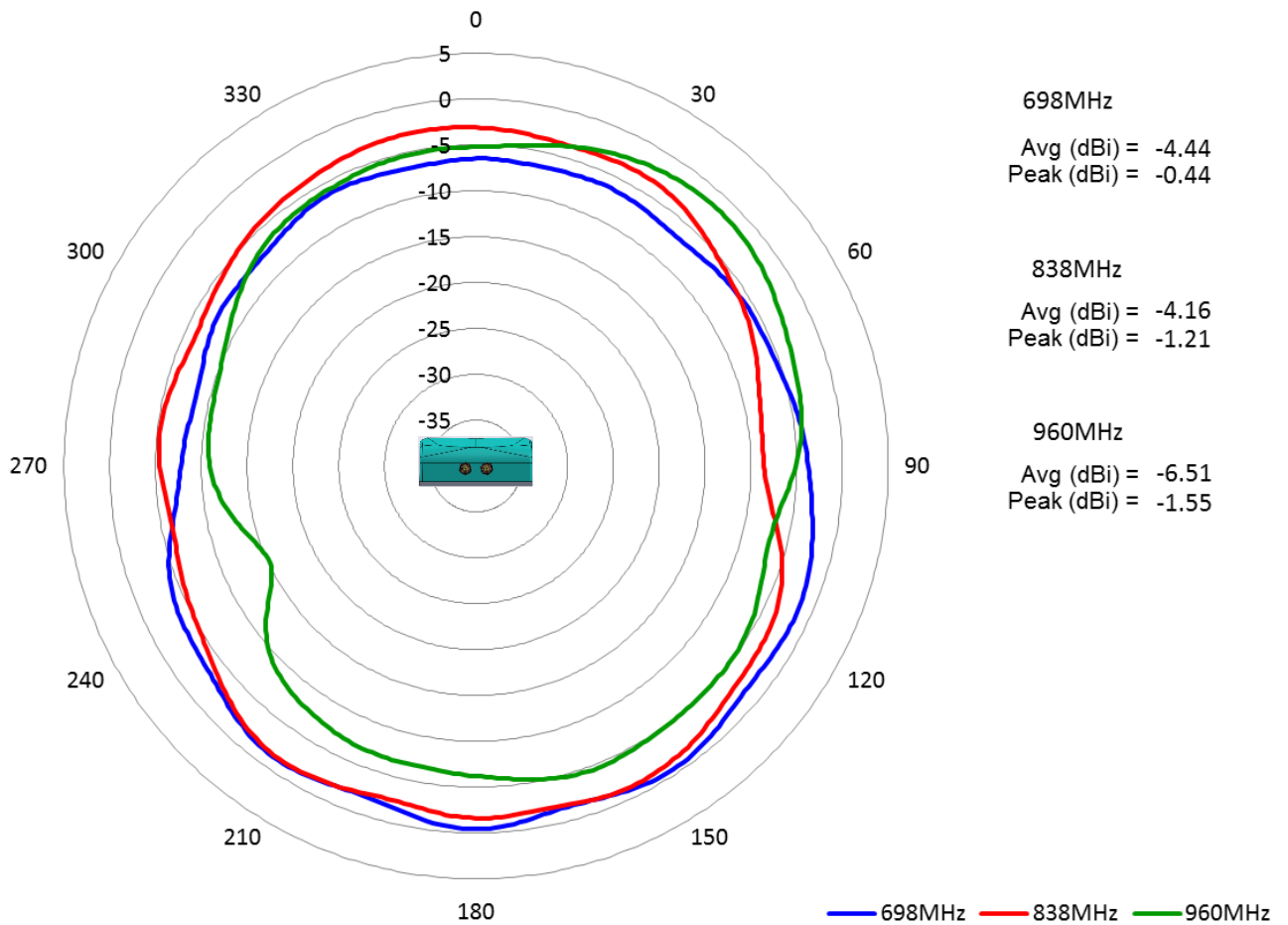

Note : Antenna measured in free space with 150mm cable

Issue: 1748P

In the effort to improve our products, we reserve the right to make changes judged to be necessary.  
CONFIDENTIAL AND PROPRIETARY INFORMATION

This document contains confidential and proprietary information of Pulse Electronics, Inc. (Pulse) and is protected by copyright, trade secret and other state and federal laws. Its receipt or possession does not convey any rights to reproduce, disclose its contents, or to manufacture, use or sell anything it may describe. Reproduction, disclosure or use without specific written authorization of Pulse is strictly forbidden.

Preliminary



Description: 3G/4G LTE 2xMiMo Vehicular Antenna

Series: Jaguar

PART NUMBER: W1919

CHARTS

Gain Plots (Main LTE)

ZY Plane

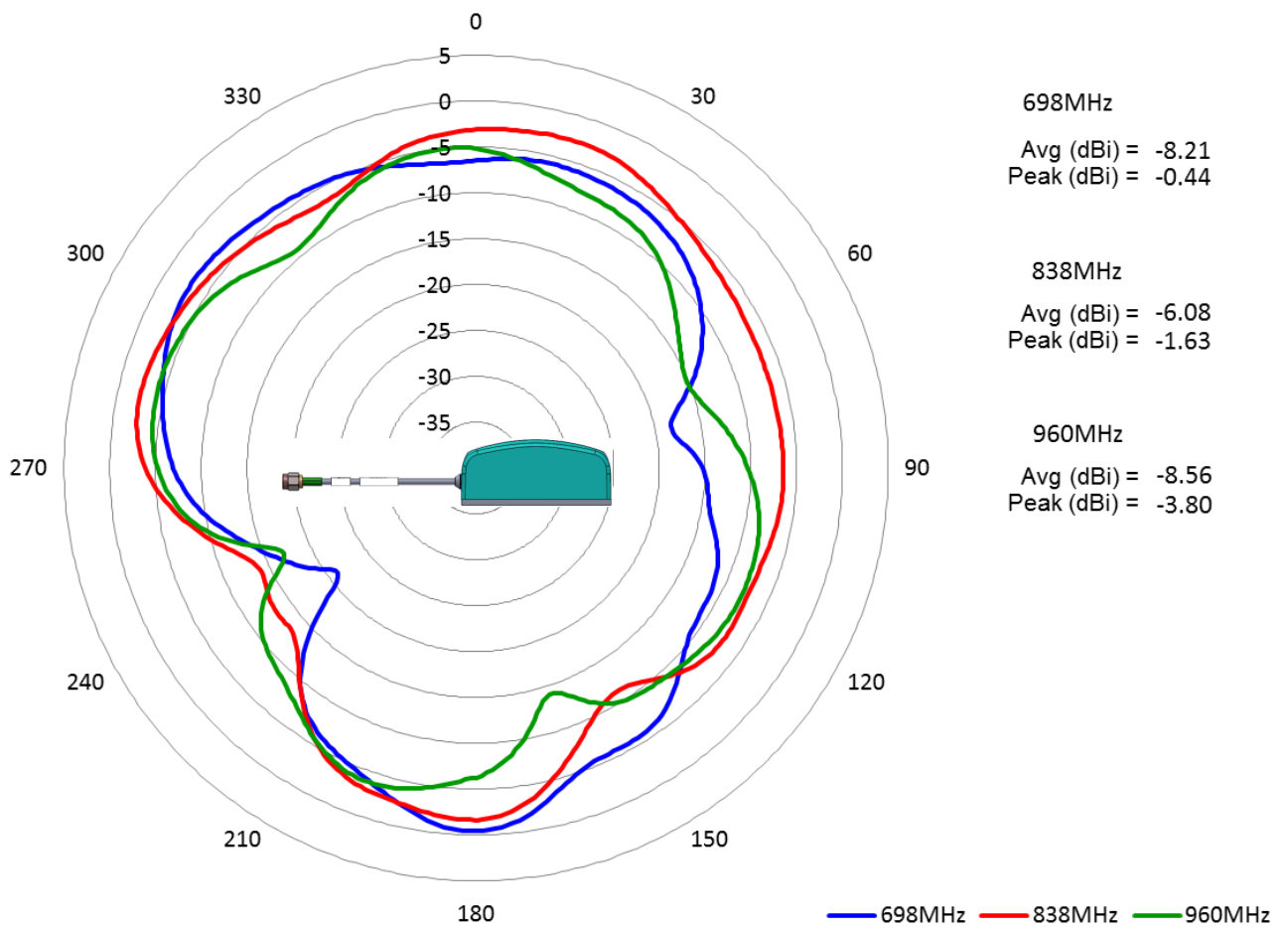

Note : Antenna measured in free space with 150mm cable

Issue: 1748P

In the effort to improve our products, we reserve the right to make changes judged to be necessary.  
CONFIDENTIAL AND PROPRIETARY INFORMATION

This document contains confidential and proprietary information of Pulse Electronics, Inc. (Pulse) and is protected by copyright, trade secret and other state and federal laws. Its receipt or possession does not convey any rights to reproduce, disclose its contents, or to manufacture, use or sell anything it may describe. Reproduction, disclosure or use without specific written authorization of Pulse is strictly forbidden.

Preliminary





Description: 3G/4G LTE 2xMiMo Vehicular Antenna

Series: Jaguar

PART NUMBER: W1919

CHARTS

Gain Plots (Main LTE)

XY Plane

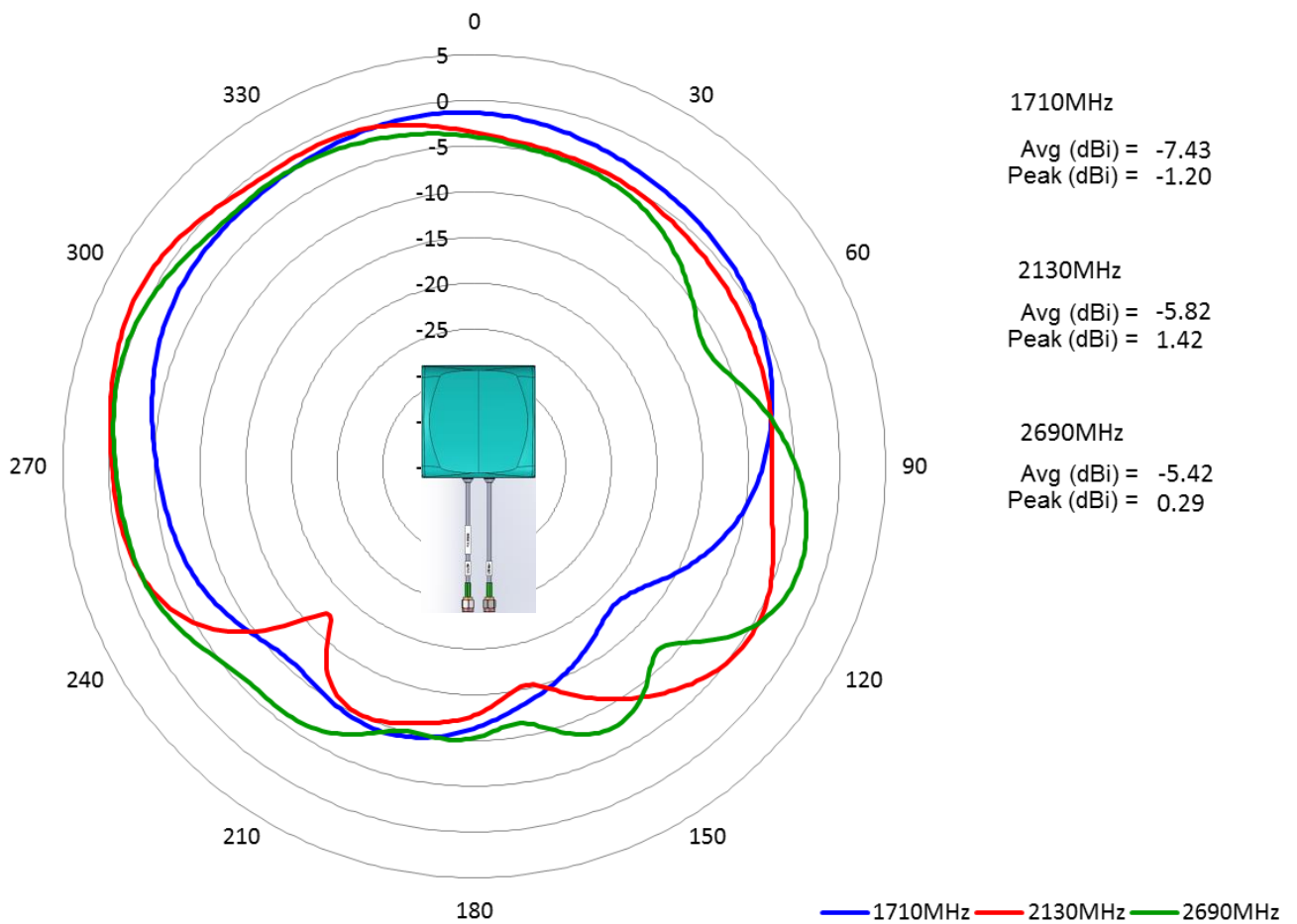

Note : Antenna measured in free space with 150mm cable

Issue: 1748P

In the effort to improve our products, we reserve the right to make changes judged to be necessary.

CONFIDENTIAL AND PROPRIETARY INFORMATION

This document contains confidential and proprietary information of Pulse Electronics, Inc. (Pulse) and is protected by copyright, trade secret and other state and federal laws. Its receipt or possession does not convey any rights to reproduce, disclose its contents, or to manufacture, use or sell anything it may describe. Reproduction, disclosure or use without specific written authorization of Pulse is strictly forbidden.

Preliminary



Description: 3G/4G LTE 2xMiMo Vehicular Antenna

Series: Jaguar

PART NUMBER: W1919

CHARTS

Gain Plots (Main LTE)

ZX Plane

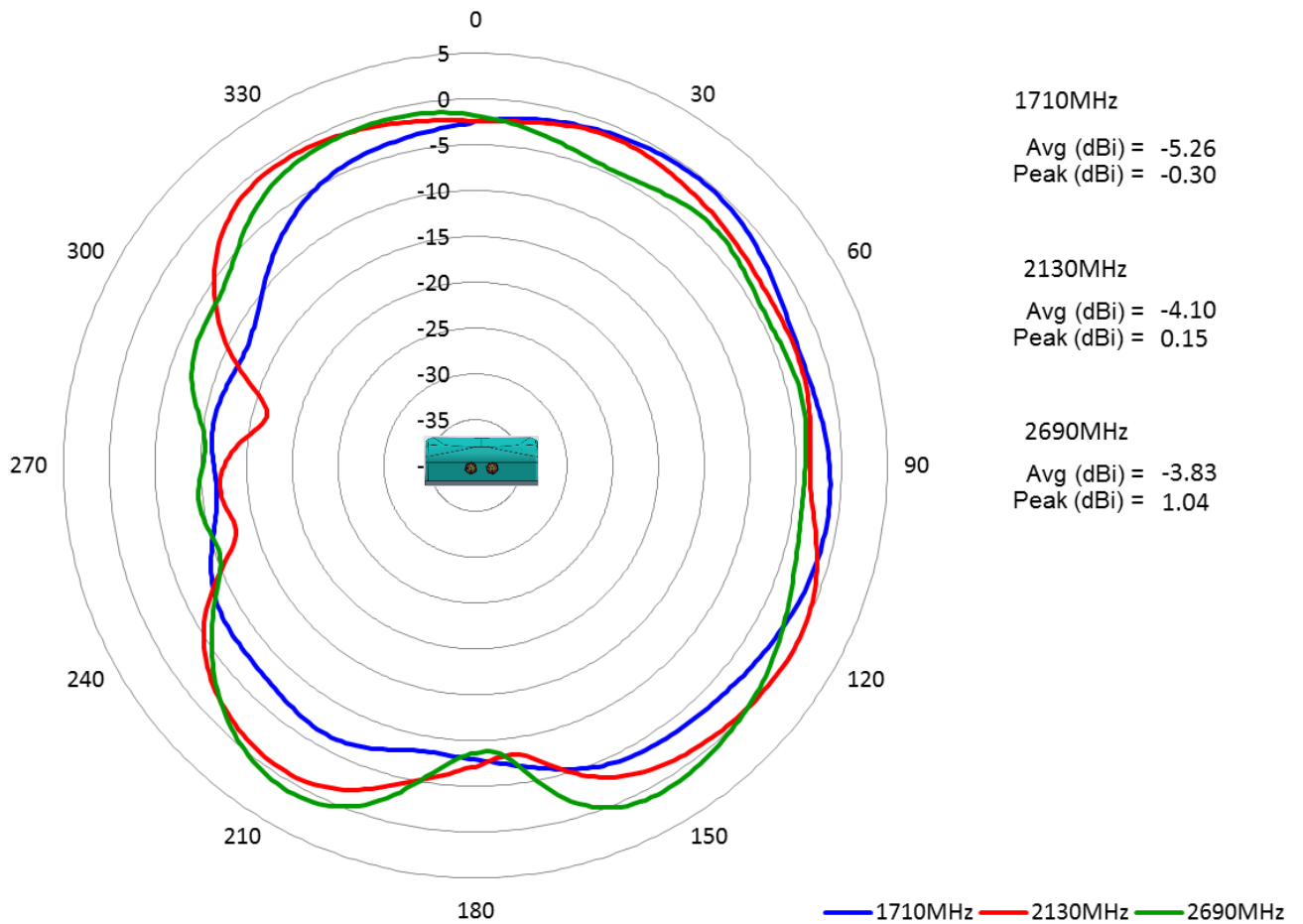

Note : Antenna measured in free space with 150mm cable

Issue: 1748P

In the effort to improve our products, we reserve the right to make changes judged to be necessary.  
CONFIDENTIAL AND PROPRIETARY INFORMATION

This document contains confidential and proprietary information of Pulse Electronics, Inc. (Pulse) and is protected by copyright, trade secret and other state and federal laws. Its receipt or possession does not convey any rights to reproduce, disclose its contents, or to manufacture, use or sell anything it may describe. Reproduction, disclosure or use without specific written authorization of Pulse is strictly forbidden.

Preliminary



Description: 3G/4G LTE 2xMiMo Vehicular Antenna

Series: Jaguar

PART NUMBER: W1919

CHARTS

Gain Plots (Main LTE)

ZY Plane

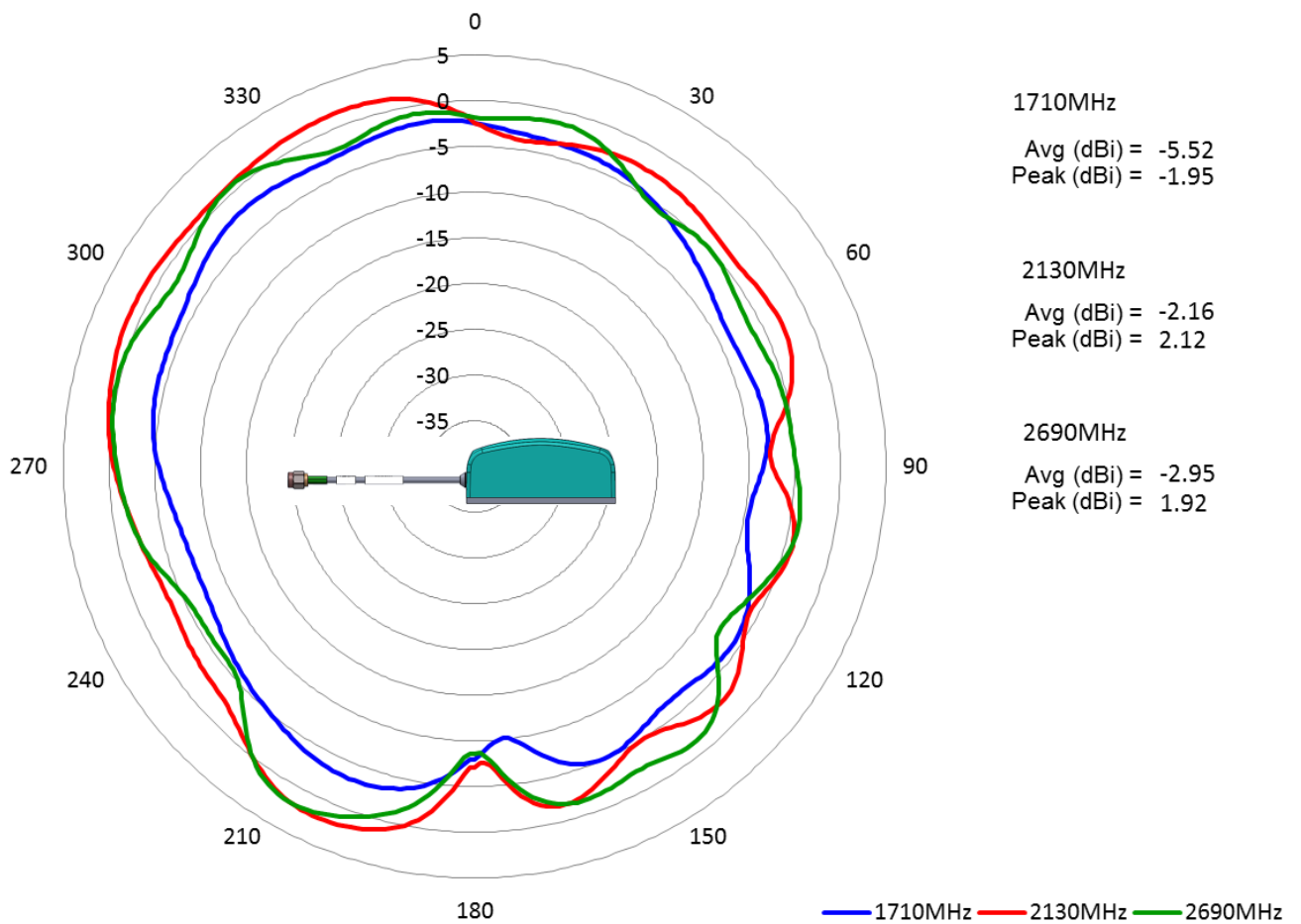

Note : Antenna measured in free space with 150mm cable

Issue: 1748P

In the effort to improve our products, we reserve the right to make changes judged to be necessary.  
CONFIDENTIAL AND PROPRIETARY INFORMATION

This document contains confidential and proprietary information of Pulse Electronics, Inc. (Pulse) and is protected by copyright, trade secret and other state and federal laws. Its receipt or possession does not convey any rights to reproduce, disclose its contents, or to manufacture, use or sell anything it may describe. Reproduction, disclosure or use without specific written authorization of Pulse is strictly forbidden.

Preliminary



Description: 3G/4G LTE 2xMiMo Vehicular Antenna

Series: Jaguar

PART NUMBER: W1919

CHARTS

Gain Plots (Main LTE)

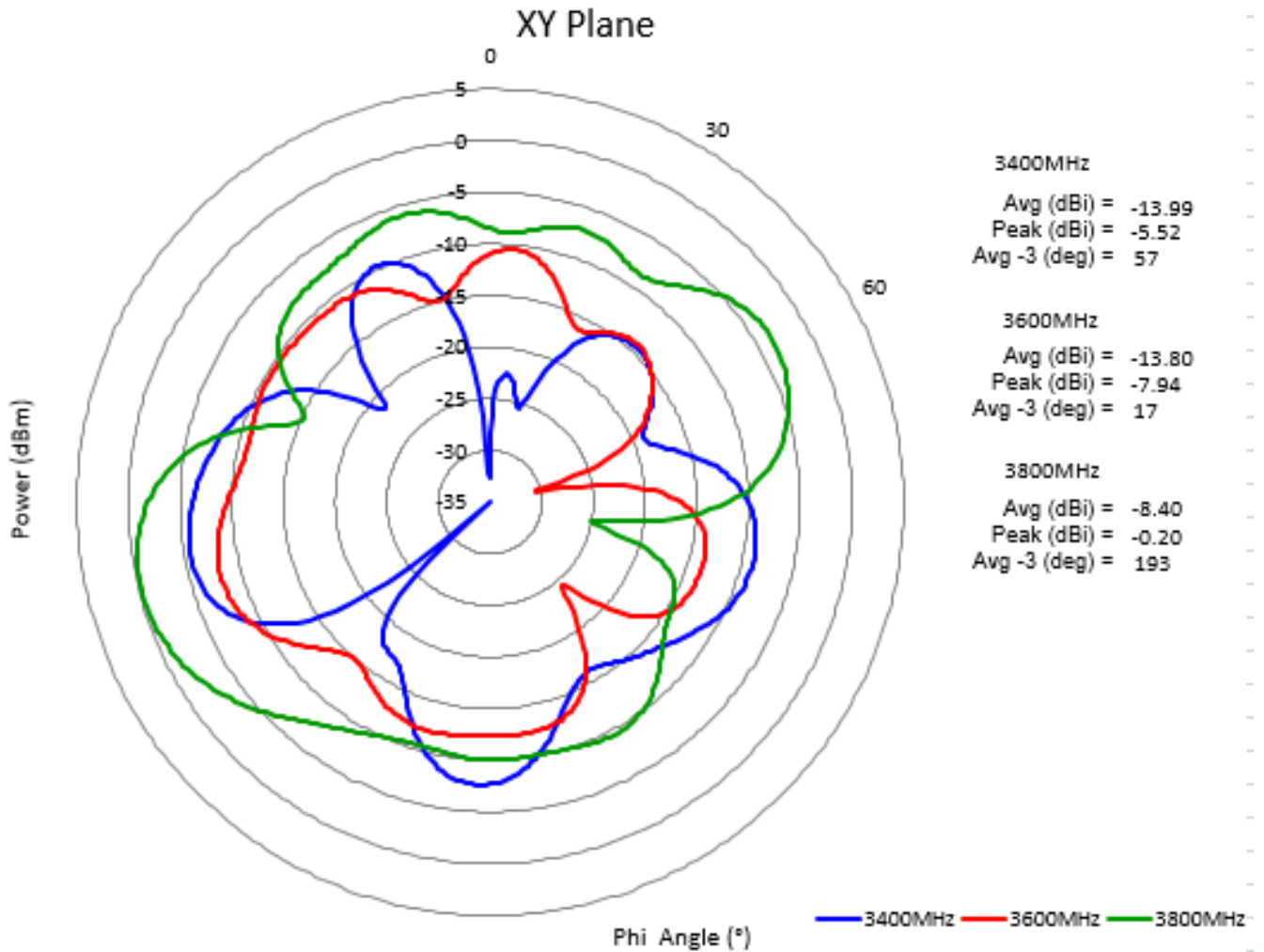

Note : Antenna measured in free space with 150mm cable

Issue: 1748P

In the effort to improve our products, we reserve the right to make changes judged to be necessary.  
CONFIDENTIAL AND PROPRIETARY INFORMATION

This document contains confidential and proprietary information of Pulse Electronics, Inc. (Pulse) and is protected by copyright, trade secret and other state and federal laws. Its receipt or possession does not convey any rights to reproduce, disclose its contents, or to manufacture, use or sell anything it may describe. Reproduction, disclosure or use without specific written authorization of Pulse is strictly forbidden.

Preliminary

Description: 3G/4G LTE 2xMiMo Vehicular Antenna

Series: Jaguar

PART NUMBER: W1919

CHARTS

Gain Plots (Main LTE)

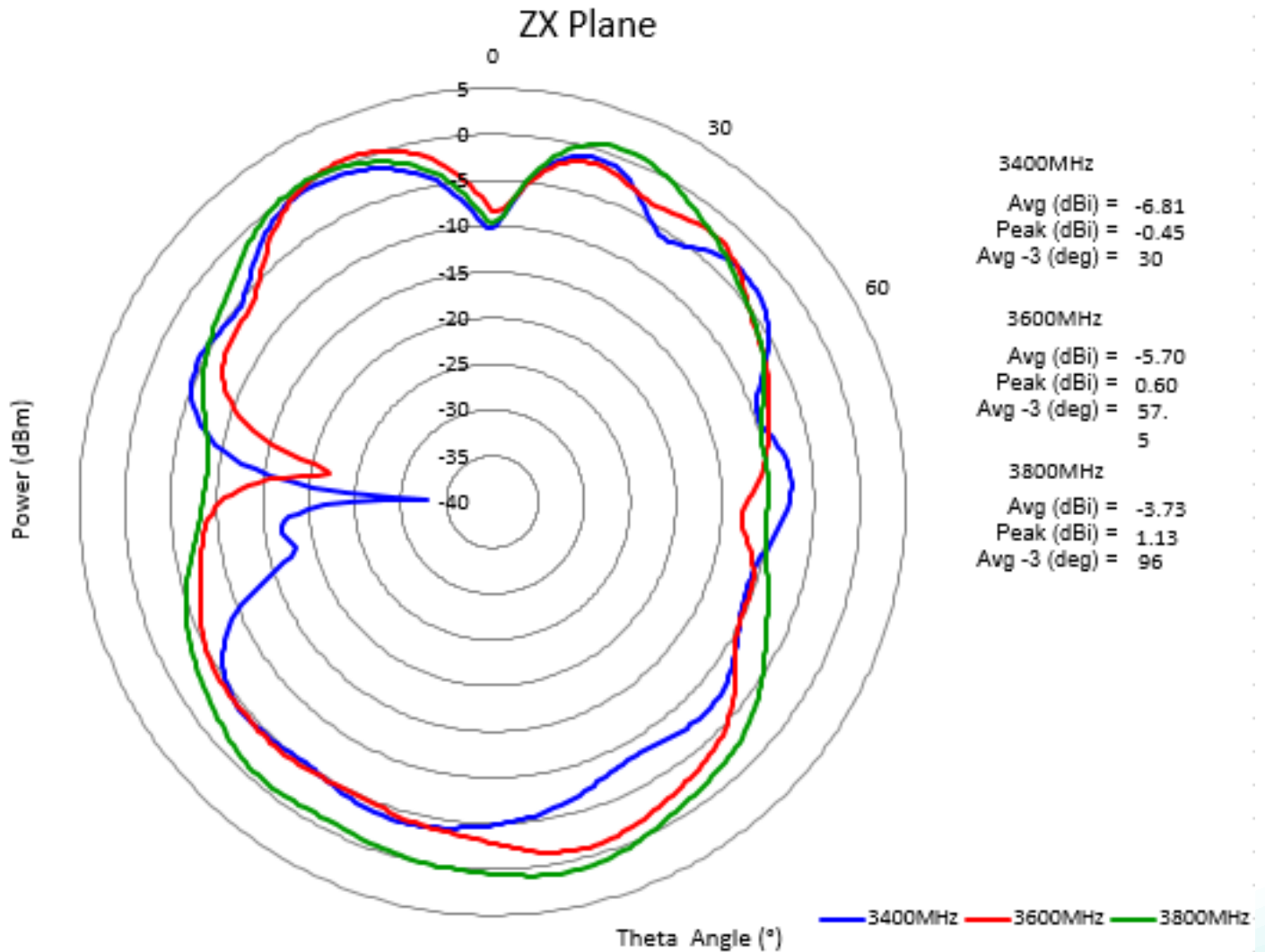

Note : Antenna measured in free space with 150mm cable

Issue: 1748P

In the effort to improve our products, we reserve the right to make changes judged to be necessary.  
CONFIDENTIAL AND PROPRIETARY INFORMATION

This document contains confidential and proprietary information of Pulse Electronics, Inc. (Pulse) and is protected by copyright, trade secret and other state and federal laws. Its receipt or possession does not convey any rights to reproduce, disclose its contents, or to manufacture, use or sell anything it may describe. Reproduction, disclosure or use without specific written authorization of Pulse is strictly forbidden.

Preliminary

Description: 3G/4G LTE 2xMiMo Vehicular Antenna

Series: Jaguar

PART NUMBER: W1919

CHARTS

Gain Plots (Main LTE)

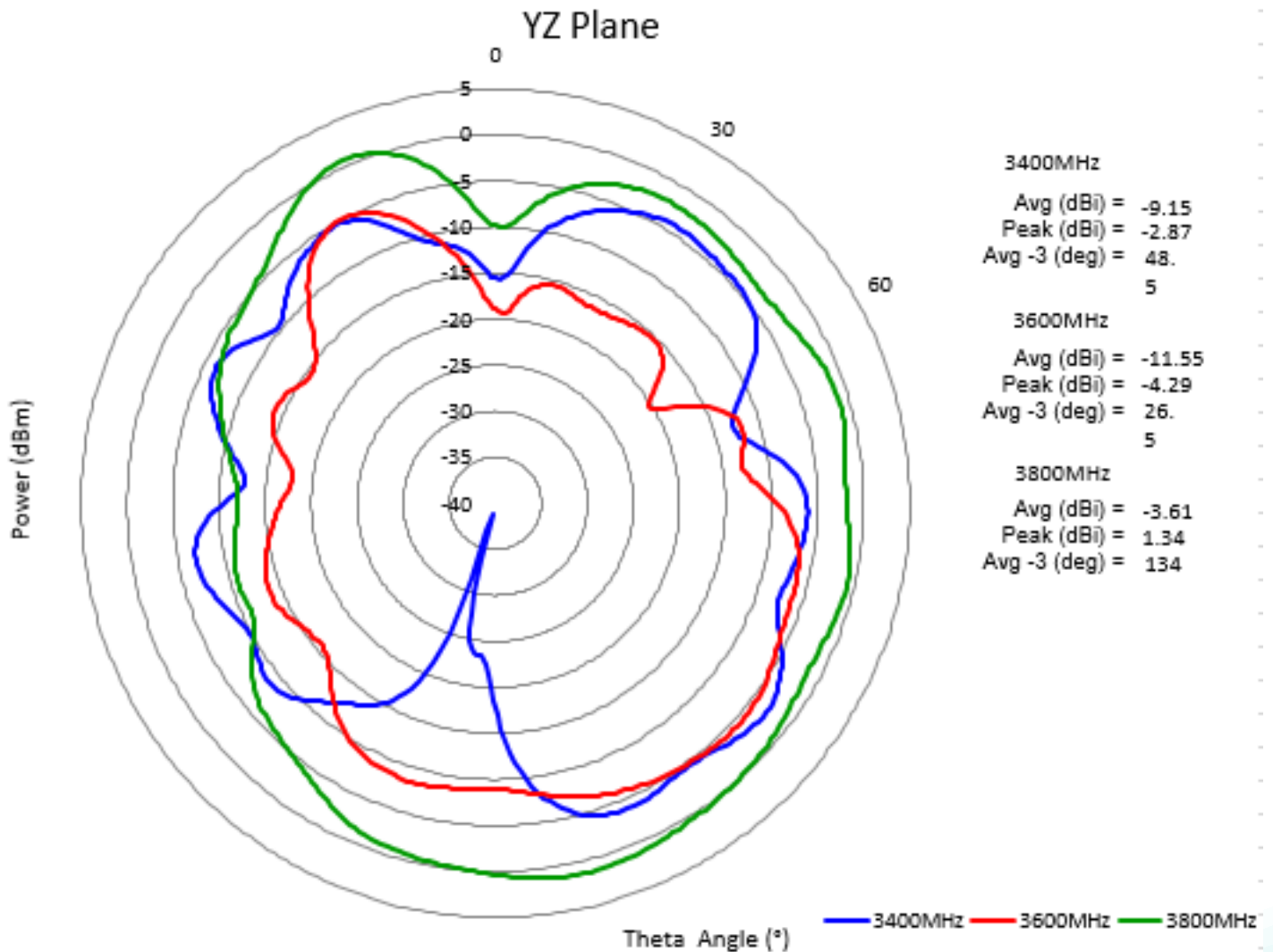

Note : Antenna measured in free space with 150mm cable

Issue: 1748P

In the effort to improve our products, we reserve the right to make changes judged to be necessary.  
CONFIDENTIAL AND PROPRIETARY INFORMATION

This document contains confidential and proprietary information of Pulse Electronics, Inc. (Pulse) and is protected by copyright, trade secret and other state and federal laws. Its receipt or possession does not convey any rights to reproduce, disclose its contents, or to manufacture, use or sell anything it may describe. Reproduction, disclosure or use without specific written authorization of Pulse is strictly forbidden.

Preliminary

Description: 3G/4G LTE 2xMiMo Vehicular Antenna

Series: Jaguar

PART NUMBER: W1919

CHARTS

Gain Plots (Diversity LTE)

XY Plane

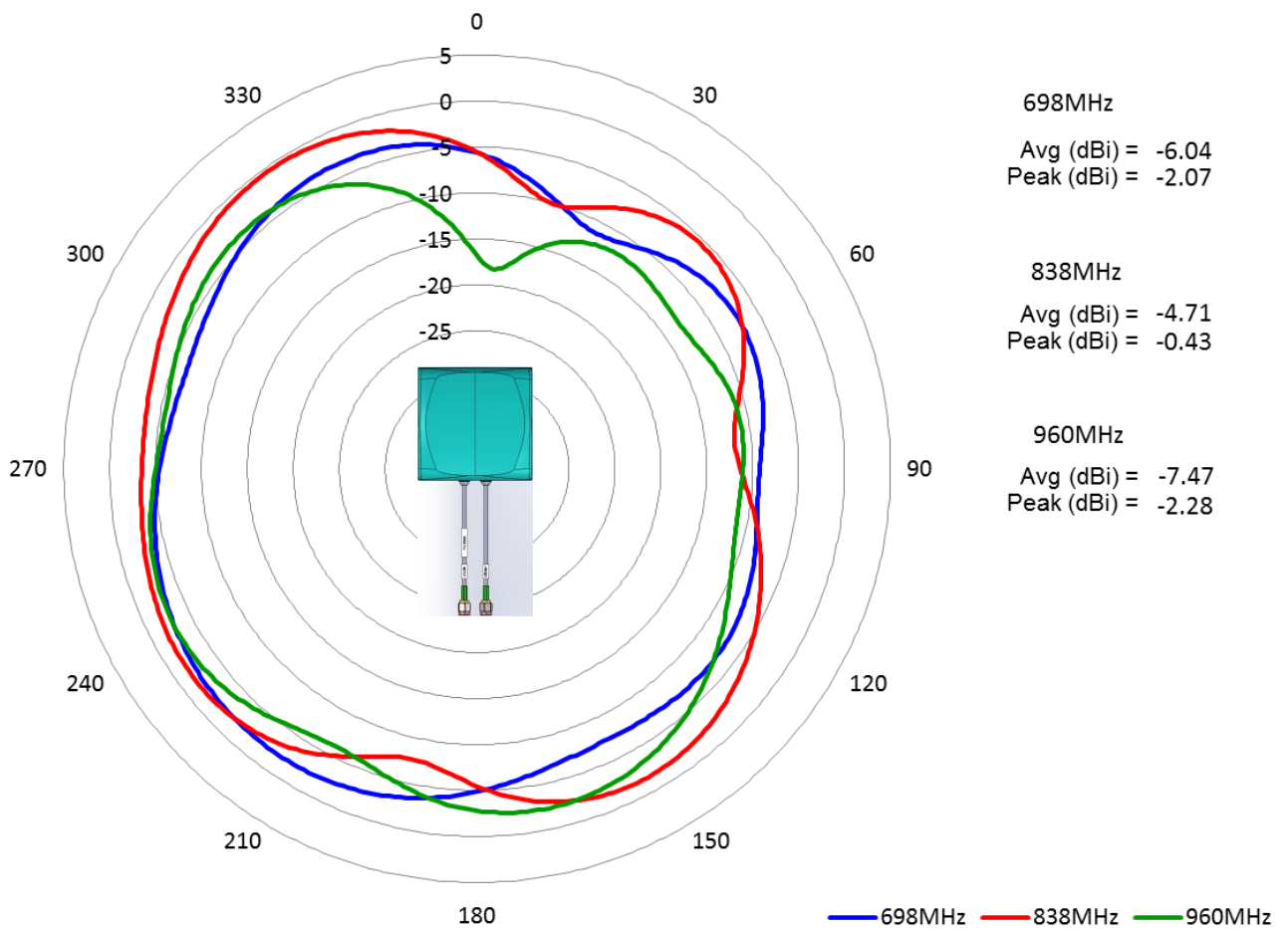

Note : Antenna measured in free space with 150mm cable

Issue: 1748P

In the effort to improve our products, we reserve the right to make changes judged to be necessary.  
CONFIDENTIAL AND PROPRIETARY INFORMATION

This document contains confidential and proprietary information of Pulse Electronics, Inc. (Pulse) and is protected by copyright, trade secret and other state and federal laws. Its receipt or possession does not convey any rights to reproduce, disclose its contents, or to manufacture, use or sell anything it may describe. Reproduction, disclosure or use without specific written authorization of Pulse is strictly forbidden.

Preliminary



Description: 3G/4G LTE 2xMiMo Vehicular Antenna

Series: Jaguar

PART NUMBER: W1919

CHARTS

Gain Plots (Diversity LTE)

ZX Plane

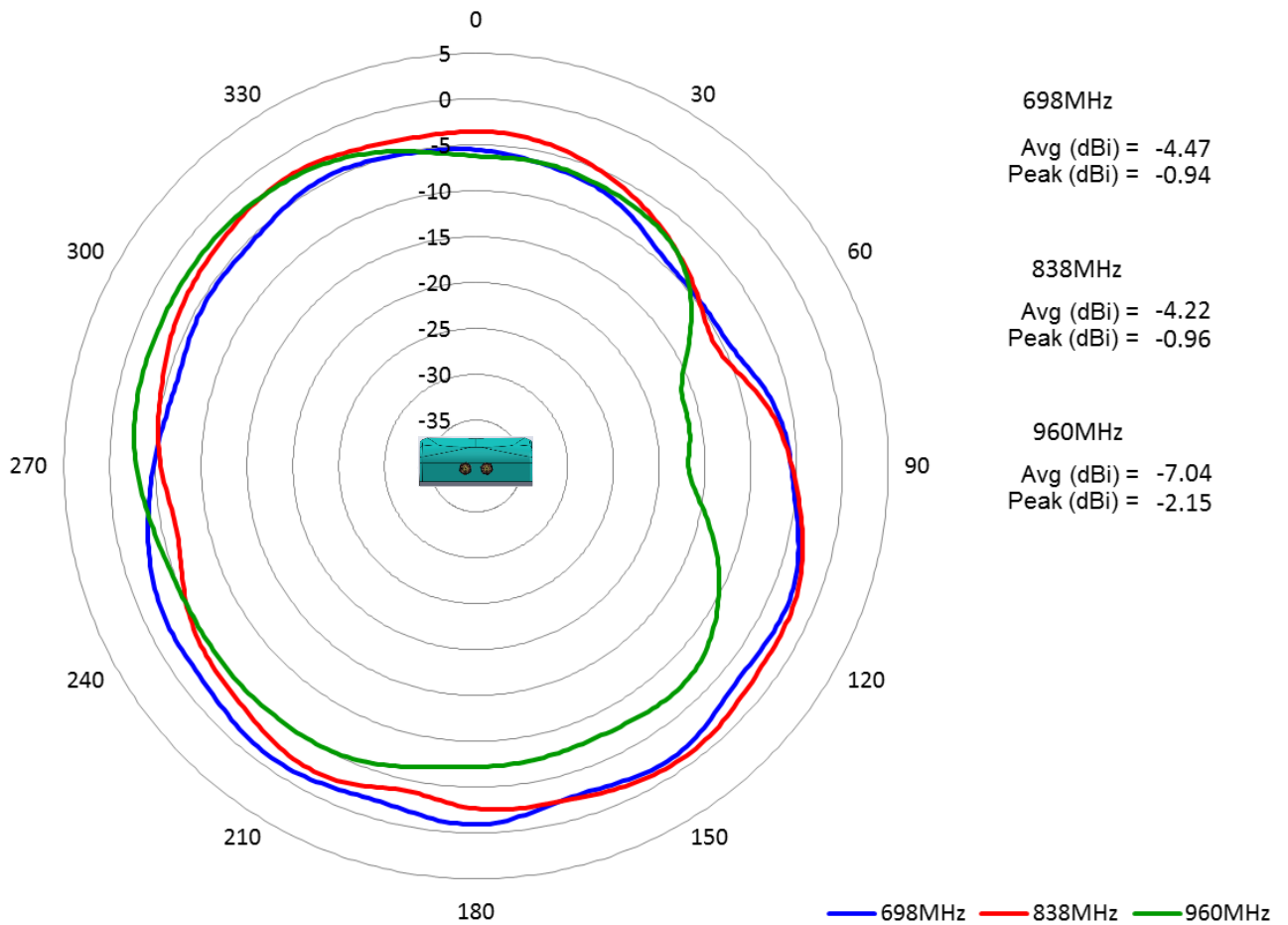

Note : Antenna measured in free space with 150mm cable

Issue: 1748P

In the effort to improve our products, we reserve the right to make changes judged to be necessary.

CONFIDENTIAL AND PROPRIETARY INFORMATION

This document contains confidential and proprietary information of Pulse Electronics, Inc. (Pulse) and is protected by copyright, trade secret and other state and federal laws. Its receipt or possession does not convey any rights to reproduce, disclose its contents, or to manufacture, use or sell anything it may describe. Reproduction, disclosure or use without specific written authorization of Pulse is strictly forbidden.

Preliminary





Description: 3G/4G LTE 2xMiMo Vehicular Antenna

Series: Jaguar

PART NUMBER: W1919

CHARTS

Gain Plots (Diversity LTE)

ZY Plane

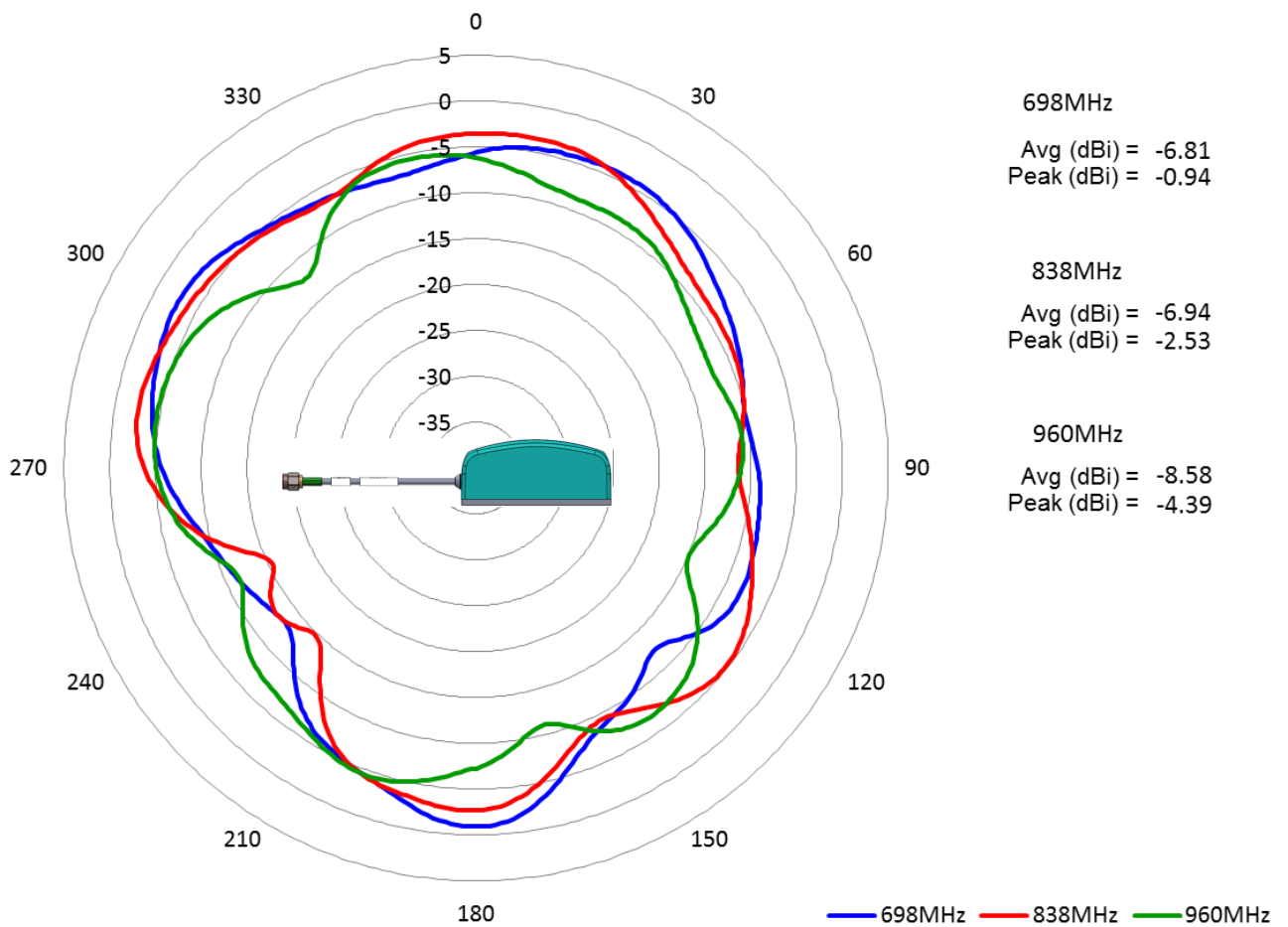

Note : Antenna measured in free space with 150mm cable

Issue: 1748P

In the effort to improve our products, we reserve the right to make changes judged to be necessary.

CONFIDENTIAL AND PROPRIETARY INFORMATION

This document contains confidential and proprietary information of Pulse Electronics, Inc. (Pulse) and is protected by copyright, trade secret and other state and federal laws. Its receipt or possession does not convey any rights to reproduce, disclose its contents, or to manufacture, use or sell anything it may describe. Reproduction, disclosure or use without specific written authorization of Pulse is strictly forbidden.

Preliminary



Description: 3G/4G LTE 2xMiMo Vehicular Antenna

Series: Jaguar

PART NUMBER: W1919

CHARTS

Gain Plots (Diversity LTE)

XY Plane

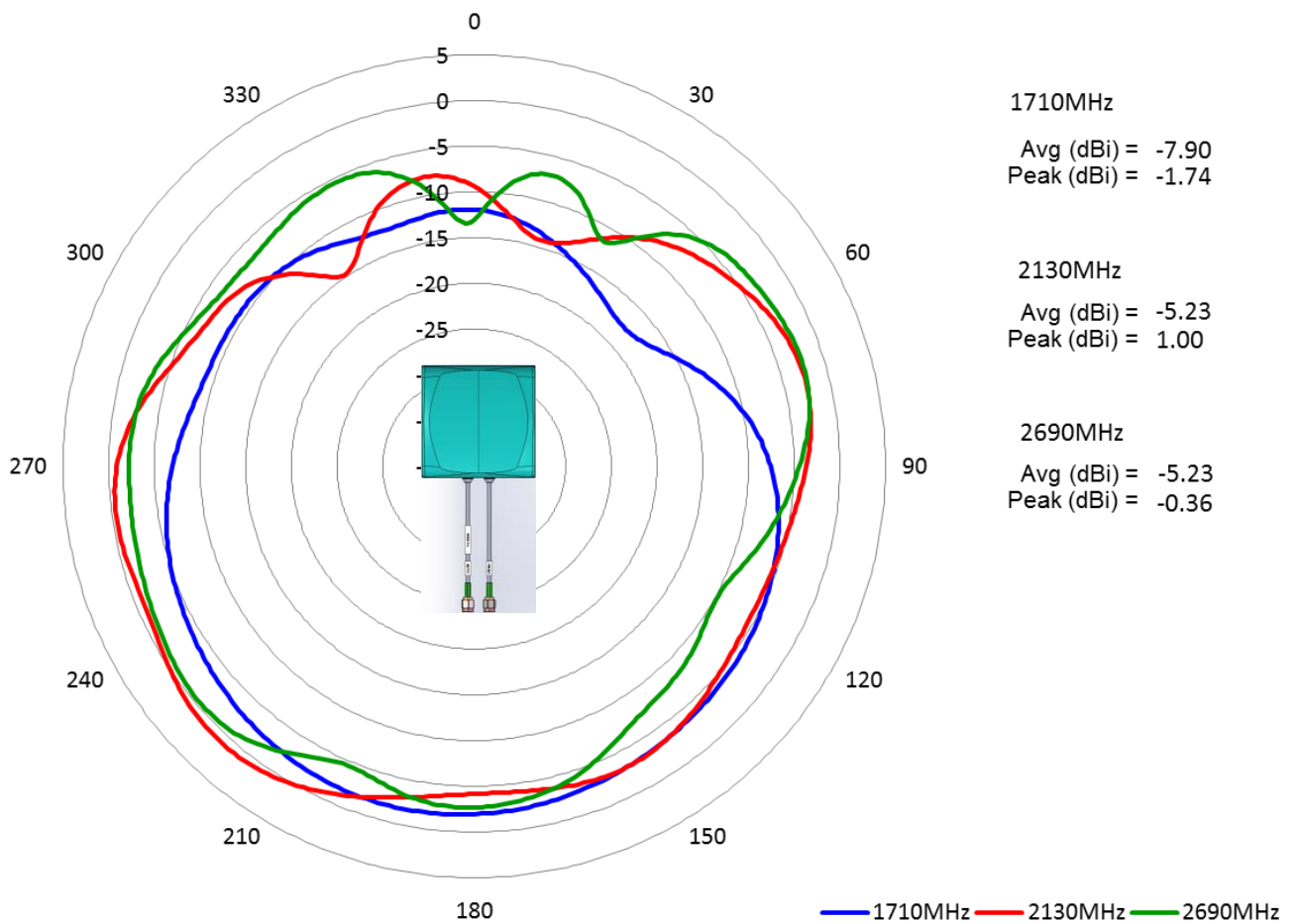

Note : Antenna measured in free space with 150mm cable

Issue: 1748P

In the effort to improve our products, we reserve the right to make changes judged to be necessary.  
CONFIDENTIAL AND PROPRIETARY INFORMATION

This document contains confidential and proprietary information of Pulse Electronics, Inc. (Pulse) and is protected by copyright, trade secret and other state and federal laws. Its receipt or possession does not convey any rights to reproduce, disclose its contents, or to manufacture, use or sell anything it may describe. Reproduction, disclosure or use without specific written authorization of Pulse is strictly forbidden.

Preliminary



Description: 3G/4G LTE 2xMiMo Vehicular Antenna

Series: Jaguar

PART NUMBER: W1919

CHARTS

Gain Plots (Diversity LTE)

ZX Plane

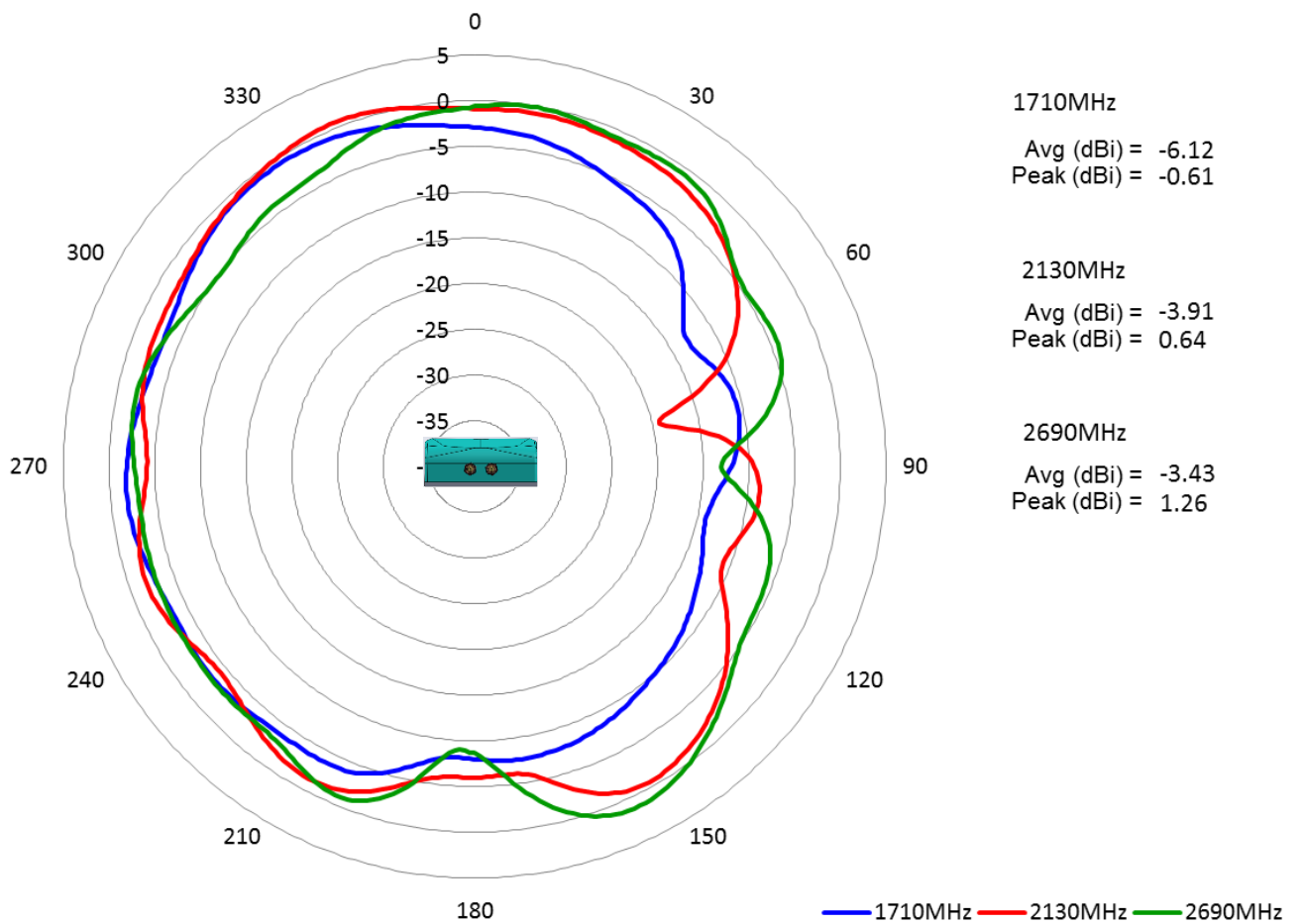

Note : Antenna measured in free space with 150mm cable

Issue: 1748P

In the effort to improve our products, we reserve the right to make changes judged to be necessary.  
CONFIDENTIAL AND PROPRIETARY INFORMATION

This document contains confidential and proprietary information of Pulse Electronics, Inc. (Pulse) and is protected by copyright, trade secret and other state and federal laws. Its receipt or possession does not convey any rights to reproduce, disclose its contents, or to manufacture, use or sell anything it may describe. Reproduction, disclosure or use without specific written authorization of Pulse is strictly forbidden.

Preliminary



Description: 3G/4G LTE 2xMiMo Vehicular Antenna

Series: Jaguar

PART NUMBER: W1919

CHARTS

Gain Plots (Diversity LTE)

ZY Plane

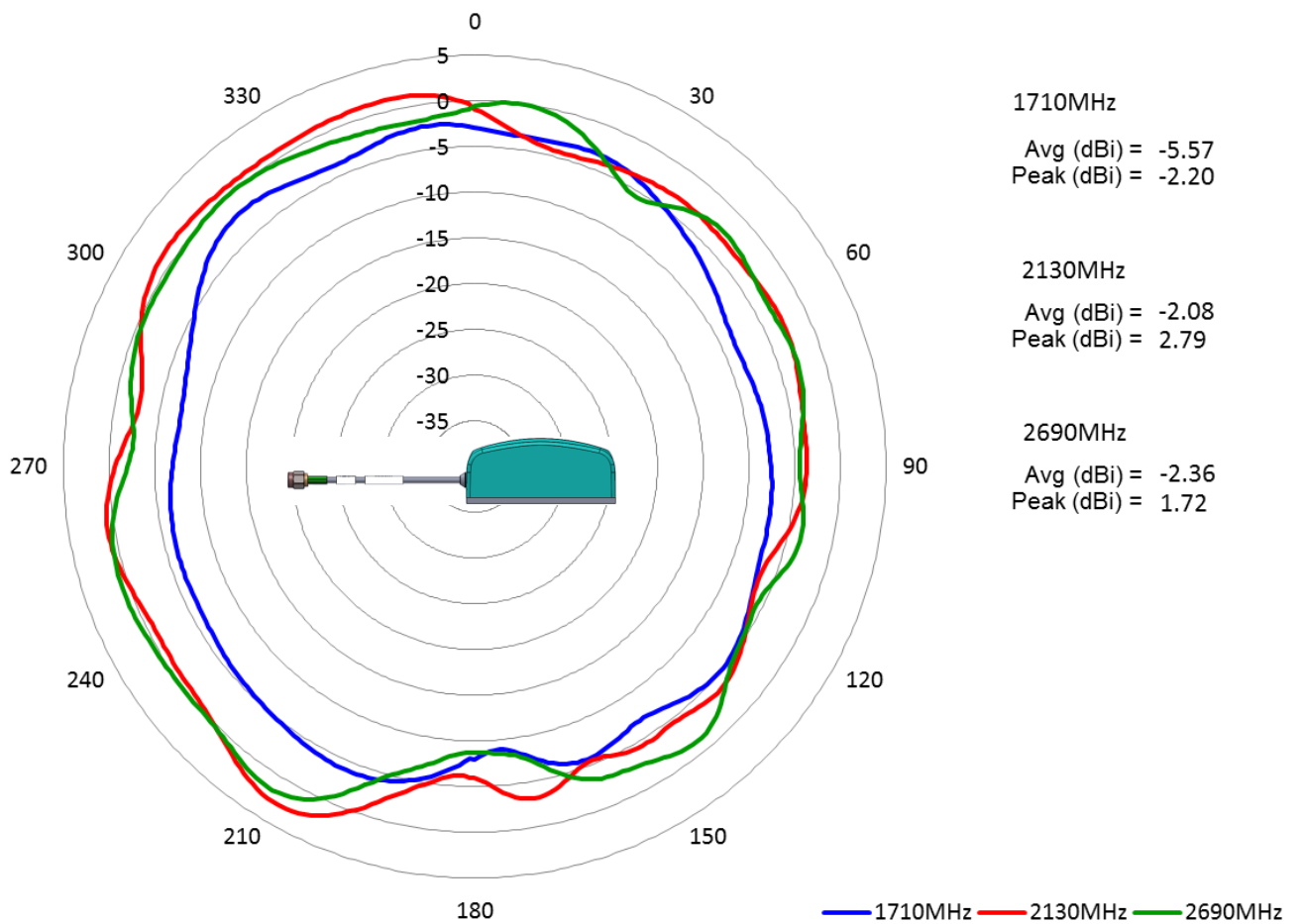

Note : Antenna measured in free space with 150mm cable

Issue: 1748P

In the effort to improve our products, we reserve the right to make changes judged to be necessary.

CONFIDENTIAL AND PROPRIETARY INFORMATION

This document contains confidential and proprietary information of Pulse Electronics, Inc. (Pulse) and is protected by copyright, trade secret and other state and federal laws. Its receipt or possession does not convey any rights to reproduce, disclose its contents, or to manufacture, use or sell anything it may describe. Reproduction, disclosure or use without specific written authorization of Pulse is strictly forbidden.

Preliminary



Description: 3G/4G LTE 2xMiMo Vehicular Antenna

Series: Jaguar

PART NUMBER: W1919

CHARTS

Gain Plots (Diversity LTE)

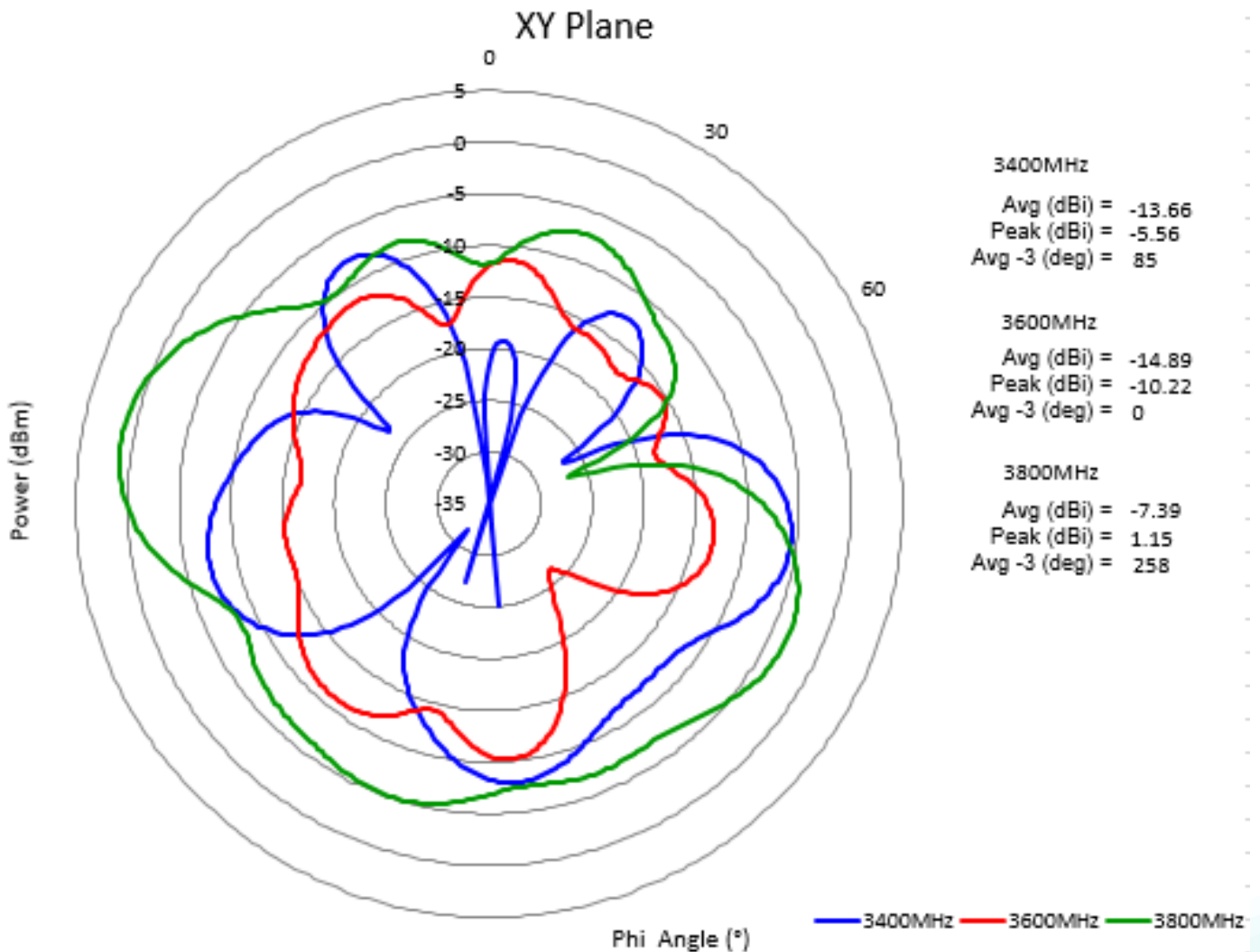

Note : Antenna measured in free space with 150mm cable

Issue: 1748P

In the effort to improve our products, we reserve the right to make changes judged to be necessary.  
CONFIDENTIAL AND PROPRIETARY INFORMATION

This document contains confidential and proprietary information of Pulse Electronics, Inc. (Pulse) and is protected by copyright, trade secret and other state and federal laws. Its receipt or possession does not convey any rights to reproduce, disclose its contents, or to manufacture, use or sell anything it may describe. Reproduction, disclosure or use without specific written authorization of Pulse is strictly forbidden.

Preliminary

Description: 3G/4G LTE 2xMiMo Vehicular Antenna

Series: Jaguar

PART NUMBER: W1919

CHARTS

Gain Plots (Diversity LTE)

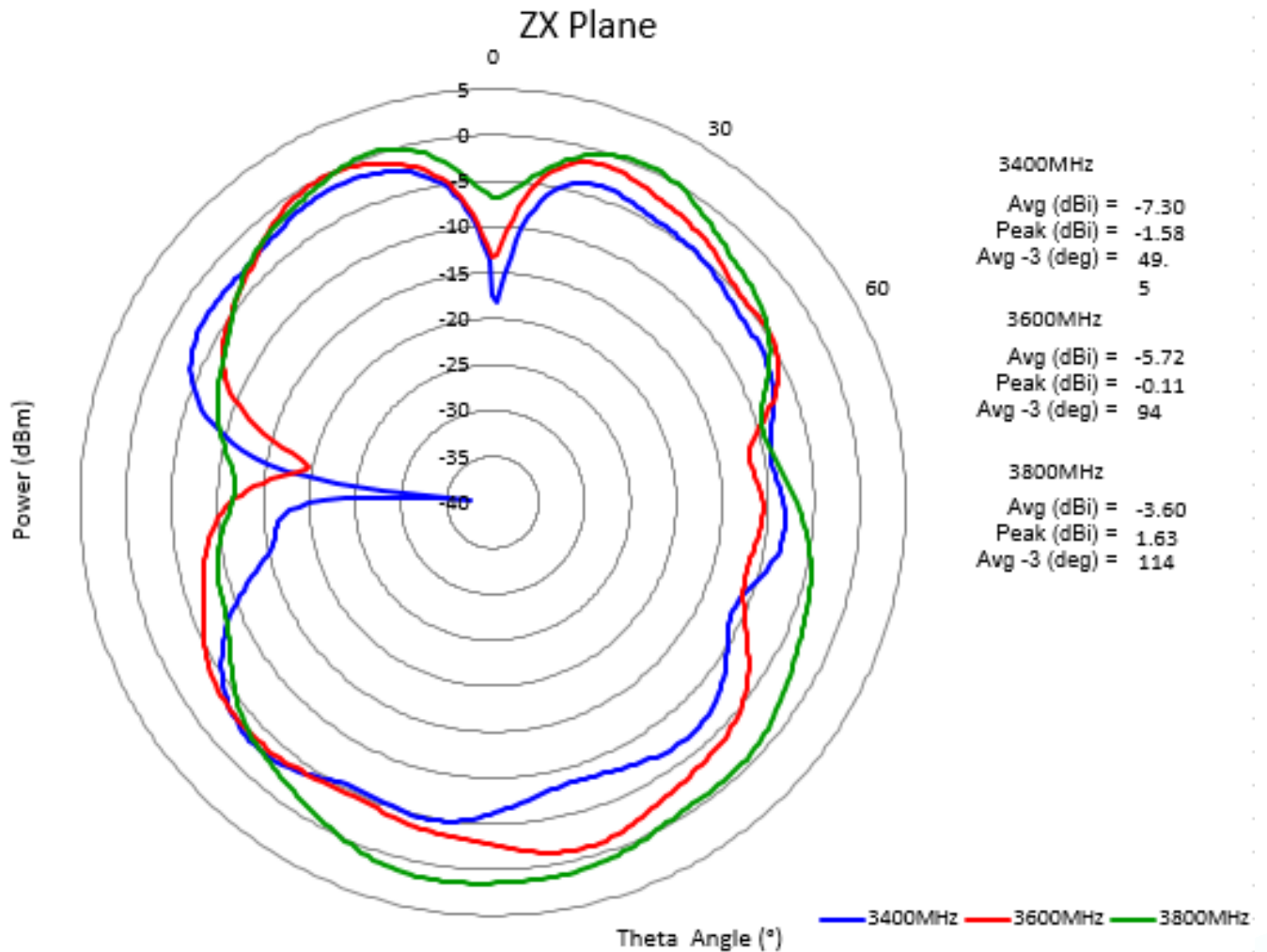

Note : Antenna measured in free space with 150mm cable

Issue: 1748P

In the effort to improve our products, we reserve the right to make changes judged to be necessary.  
CONFIDENTIAL AND PROPRIETARY INFORMATION

This document contains confidential and proprietary information of Pulse Electronics, Inc. (Pulse) and is protected by copyright, trade secret and other state and federal laws. Its receipt or possession does not convey any rights to reproduce, disclose its contents, or to manufacture, use or sell anything it may describe. Reproduction, disclosure or use without specific written authorization of Pulse is strictly forbidden.

Preliminary

Description: 3G/4G LTE 2xMiMo Vehicular Antenna

Series: Jaguar

PART NUMBER: W1919

CHARTS

Gain Plots (Diversity LTE)

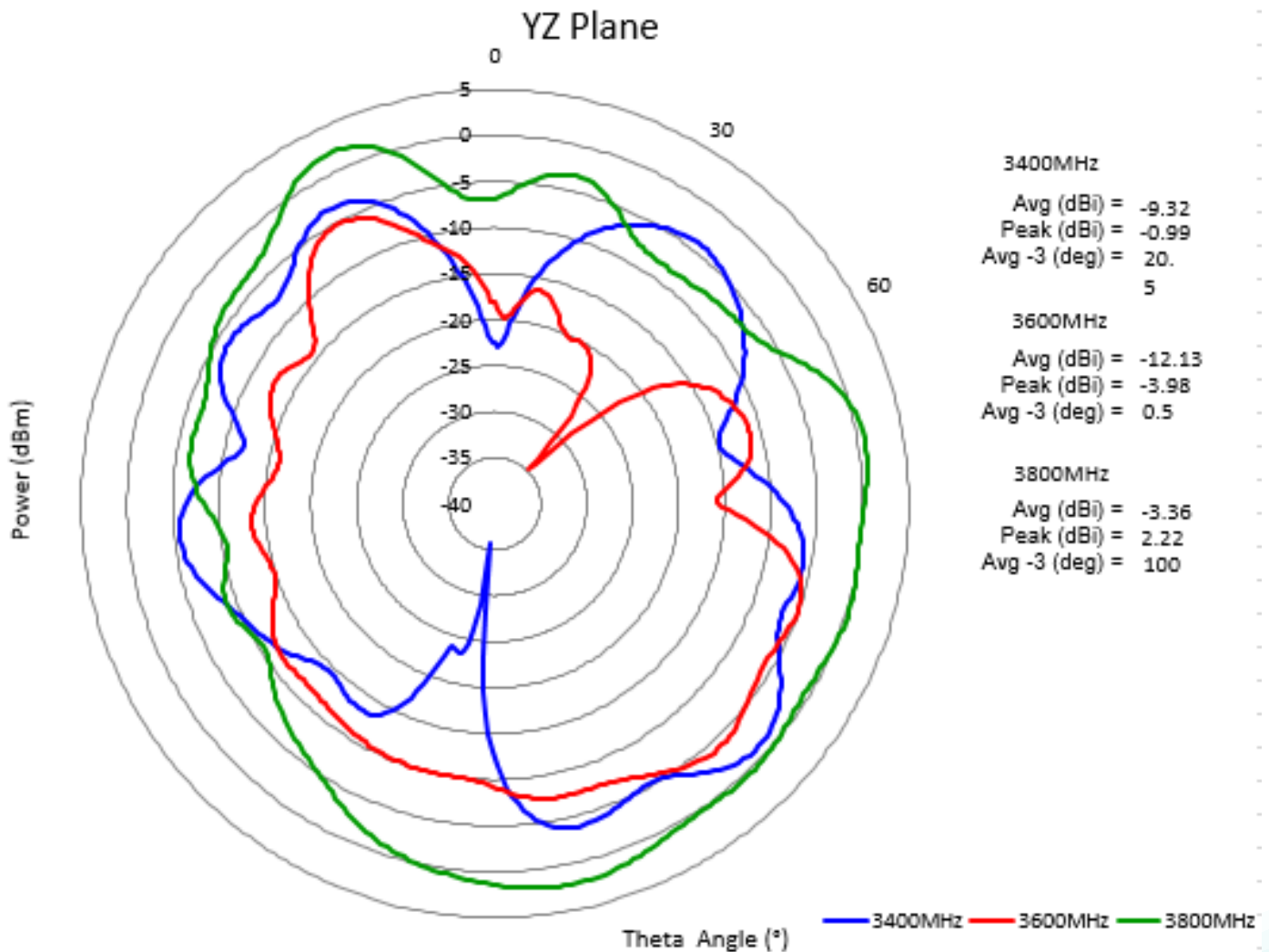

Note : Antenna measured in free space with 150mm cable

Issue: 1748P

In the effort to improve our products, we reserve the right to make changes judged to be necessary.  
CONFIDENTIAL AND PROPRIETARY INFORMATION

This document contains confidential and proprietary information of Pulse Electronics, Inc. (Pulse) and is protected by copyright, trade secret and other state and federal laws. Its receipt or possession does not convey any rights to reproduce, disclose its contents, or to manufacture, use or sell anything it may describe. Reproduction, disclosure or use without specific written authorization of Pulse is strictly forbidden.

Preliminary

Series: Jaguar

Description: 3G/4G LTE 2xMiMo Vehicular Antenna

PART NUMBER: W1919

## PACKAGING

1pcs antennas per foam bag

12pcs antennas per package box

Package box: 558mm\*386mm\*210mm

Issue: 1748P

In the effort to improve our products, we reserve the right to make changes judged to be necessary.

CONFIDENTIAL AND PROPRIETARY INFORMATION

This document contains confidential and proprietary information of Pulse Electronics, Inc. (Pulse) and is protected by copyright, trade secret and other state and federal laws. Its receipt or possession does not convey any rights to reproduce, disclose its contents, or to manufacture, use or sell anything it may describe. Reproduction, disclosure or use without specific written authorization of Pulse is strictly forbidden.

Preliminary







Компания «ЭлектроПласт» предлагает заключение долгосрочных отношений при поставках импортных электронных компонентов на взаимовыгодных условиях!

Наши преимущества:

- Оперативные поставки широкого спектра электронных компонентов отечественного и импортного производства напрямую от производителей и с крупнейших мировых складов;
- Поставка более 17-ти миллионов наименований электронных компонентов;
- Поставка сложных, дефицитных, либо снятых с производства позиций;
- Оперативные сроки поставки под заказ (от 5 рабочих дней);
- Экспресс доставка в любую точку России;
- Техническая поддержка проекта, помощь в подборе аналогов, поставка прототипов;
- Система менеджмента качества сертифицирована по Международному стандарту ISO 9001;
- Лицензия ФСБ на осуществление работ с использованием сведений, составляющих государственную тайну;
- Поставка специализированных компонентов (Xilinx, Altera, Analog Devices, Intersil, Interpoint, Microsemi, Aeroflex, Peregrine, Syfer, Eurofarad, Texas Instrument, Miteq, Cobham, E2V, MA-COM, Hittite, Mini-Circuits, General Dynamics и др.);

Помимо этого, одним из направлений компании «ЭлектроПласт» является направление «Источники питания». Мы предлагаем Вам помощь Конструкторского отдела:

- Подбор оптимального решения, техническое обоснование при выборе компонента;
- Подбор аналогов;
- Консультации по применению компонента;
- Поставка образцов и прототипов;
- Техническая поддержка проекта;
- Защита от снятия компонента с производства.



#### Как с нами связаться

**Телефон:** 8 (812) 309 58 32 (многоканальный)

**Факс:** 8 (812) 320-02-42

**Электронная почта:** [org@eplast1.ru](mailto:org@eplast1.ru)

**Адрес:** 198099, г. Санкт-Петербург, ул. Калинина, дом 2, корпус 4, литера А.