



Highbright 0603 ChipLED



DESCRIPTION

The new ChipLED series have been designed in the smallest SMD package. This innovative ChipLED technology opens the way to

- smaller products of higher performance
- more design in flexibility
- enhanced applications

The 0603 LED is an obvious solution for small-scale, high brightness products that are expected to work reliably in an arduous environment.

PRODUCT GROUP AND PACKAGE DATA

- Product group: LED
- Package: SMD 0603 ChipLED
- Product series: standard
- Angle of half intensity: $\pm 65^\circ$

FEATURES

- Super thin ChipLED with exceptional brightness 1.6 mm x 0.8 mm x 0.8 mm (L x W x H)
- High reliability PCB based
- Wavelength (465 to 475) nm (blue), typ. 525 nm (true green), typ. 571 nm (yellow green), (584.5 to 597) nm (yellow), typ. 605 nm (soft orange), typ. 631 nm (super red)
- InGaN blue available with protection diode, device type VLMB1310 with HBM 8000 V
- AllnGaP and InGaN technology
- Viewing angle: extremely wide 130°
- Grouping parameter: luminous intensity, wavelength, V_F
- Available in 8 mm tape on 7" diameter reel
- Compatible to IR reflow soldering
- Preconditioning: according to JEDEC level 3
- Material categorization: For definitions of compliance please see www.vishay.com/doc?99912



APPLICATIONS

- Backlight keypads
- Navigation systems
- Cellular phone displays
- Displays for industrial control systems
- Miniaturized color effects
- Traffic displays

PARTS TABLE

PART	COLOR	LUMINOUS INTENSITY (mcd)			at I_F (mA)	WAVELENGTH (nm)			FORWARD VOLTAGE (V)			TECHNOLOGY
		MIN.	TYP.	MAX.		MIN.	TYP.	MAX.	MIN.	TYP.	MAX.	
VLMS1300-GS08	Super red	18	54	-	20	-	631	-	-	2.0	2.4	AllnGaP
VLMO1300-GS08	Soft orange	45	90	-	20	-	605	-	-	2.0	2.4	AllnGaP
VLMY1300-GS08	Yellow	28	-	180	20	584.5	-	597	1.8	-	2.4	AllnGaP
VLMG1300-GS08	Yellow green	18	35	-	20	-	571	-	-	2.0	2.4	AllnGaP
VLMTG1300-GS08	True green	71	-	450	20	-	525	-	2.8	3.2	3.6	InGaN
VLMB1300-GS08	Blue	28	-	180	20	465	-	475	2.8	-	3.8	InGaN
VLMB1310-GS08	Blue	28	-	180	20	465	-	475	2.8	-	3.8	InGaN



ABSOLUTE MAXIMUM RATINGS ($T_{amb} = 25\text{ }^{\circ}\text{C}$, unless otherwise specified)
VLMS1300, VLMO1300, VLMY1300, VLMG1300 (AlInGaP technology)

PARAMETER	TEST CONDITION	SYMBOL	VALUE	UNIT
Reverse voltage ⁽¹⁾		V_R	5	V
DC forward current		I_F	30	mA
Surge forward current	1/10 duty cycle, 0.1 ms pulse width	I_{FSM}	80	mA
Power dissipation	$T_{amb} \leq 25\text{ }^{\circ}\text{C}$	P_V	75	mW
Operating temperature range		T_{amb}	- 35 to + 85	$^{\circ}\text{C}$
Storage temperature range		T_{stg}	- 45 to + 85	$^{\circ}\text{C}$
IREL solder conditions	according Vishay specifications	T_{st}	260	$^{\circ}\text{C}$

Note

⁽¹⁾ Driving the LED in reverse direction is suitable for short term application

ABSOLUTE MAXIMUM RATINGS ($T_{amb} = 25\text{ }^{\circ}\text{C}$, unless otherwise specified)
VLMTG1300, VLMB1300, VLMB1310 (InGaN technology)

PARAMETER	TEST CONDITION	SYMBOL	VALUE	UNIT
DC forward current		I_F	20	mA
Surge forward current	1/10 duty cycle, 0.1 ms pulse width	I_{FSM}	100	mA
Power dissipation	$T_{amb} \leq 25\text{ }^{\circ}\text{C}$	P_V	76	mW
ESD threshold, for VLMB1310 with protection only	HBM	$th_{ESD\ HBM}$	8000	V
Operating temperature range		T_{amb}	- 20 to + 80	$^{\circ}\text{C}$
Storage temperature range		T_{stg}	- 30 to + 100	$^{\circ}\text{C}$
IREL solder conditions	according Vishay specifications	T_{st}	260	$^{\circ}\text{C}$

OPTICAL AND ELECTRICAL CHARACTERISTICS ($T_{amb} = 25\text{ }^{\circ}\text{C}$, unless otherwise specified)
VLMS1300, SUPER RED

PARAMETER	TEST CONDITION	SYMBOL	MIN.	TYP.	MAX.	UNIT
Luminous intensity	$I_F = 20\text{ mA}$	I_V	18	54	-	mcd
Dominant wavelength	$I_F = 20\text{ mA}$	λ_d	-	631	-	nm
Peak wavelength	$I_F = 20\text{ mA}$	λ_p	-	639	-	nm
Angle of half intensity	$I_F = 20\text{ mA}$	φ	-	± 65	-	deg
Spectral line half width	$I_F = 20\text{ mA}$	$\Delta\lambda$	-	20	-	nm
Forward voltage	$I_F = 20\text{ mA}$	V_F	-	2.0	2.4	V
Junction capacitance	$V_R = 0\text{ V}$, $f = 1\text{ MHz}$	C_j	-	40	-	pF
Reverse current	$V_R = 5\text{ V}$	I_R	-	-	10	μA

OPTICAL AND ELECTRICAL CHARACTERISTICS ($T_{amb} = 25\text{ }^{\circ}\text{C}$, unless otherwise specified)
VLMO1300, SOFT ORANGE

PARAMETER	TEST CONDITION	SYMBOL	MIN.	TYP.	MAX.	UNIT
Luminous intensity	$I_F = 20\text{ mA}$	I_V	45	90	-	mcd
Dominant wavelength	$I_F = 20\text{ mA}$	λ_d	-	605	-	nm
Peak wavelength	$I_F = 20\text{ mA}$	λ_p	-	611	-	nm
Angle of half intensity	$I_F = 20\text{ mA}$	φ	-	± 65	-	deg
Spectral line half width	$I_F = 20\text{ mA}$	$\Delta\lambda$	-	17	-	nm
Forward voltage	$I_F = 20\text{ mA}$	V_F	-	2.0	2.4	V
Junction capacitance	$V_R = 0\text{ V}$, $f = 1\text{ MHz}$	C_j	-	40	-	pF
Reverse current	$V_R = 5\text{ V}$	I_R	-	-	10	μA



OPTICAL AND ELECTRICAL CHARACTERISTICS ($T_{amb} = 25\text{ }^{\circ}\text{C}$, unless otherwise specified)
VLMY1300, YELLOW

PARAMETER	TEST CONDITION	SYMBOL	MIN.	TYP.	MAX.	UNIT
Luminous intensity	$I_F = 20\text{ mA}$	I_V	28	-	180	mcd
Dominant wavelength	$I_F = 20\text{ mA}$	λ_d	584.5	-	597	nm
Peak wavelength	$I_F = 20\text{ mA}$	λ_p	-	588	-	nm
Angle of half intensity	$I_F = 20\text{ mA}$	ϕ	-	± 65	-	deg
Spectral line half width	$I_F = 20\text{ mA}$	$\Delta\lambda$	-	15	-	nm
Forward voltage	$I_F = 20\text{ mA}$	V_F	1.8	-	2.4	V
Junction capacitance	$V_R = 0\text{ V}, f = 1\text{ MHz}$	C_j	-	40	-	pF
Reverse current	$V_R = 5\text{ V}$	I_R	-	-	10	μA

OPTICAL AND ELECTRICAL CHARACTERISTICS ($T_{amb} = 25\text{ }^{\circ}\text{C}$, unless otherwise specified)
VLMG1300, YELLOW GREEN

PARAMETER	TEST CONDITION	SYMBOL	MIN.	TYP.	MAX.	UNIT
Luminous intensity	$I_F = 20\text{ mA}$	I_V	18	35	-	mcd
Dominant wavelength	$I_F = 20\text{ mA}$	λ_d	-	571	-	nm
Peak wavelength	$I_F = 20\text{ mA}$	λ_p	-	574	-	nm
Angle of half intensity	$I_F = 20\text{ mA}$	ϕ	-	± 65	-	deg
Spectral line half width	$I_F = 20\text{ mA}$	$\Delta\lambda$	-	15	-	nm
Forward voltage	$I_F = 20\text{ mA}$	V_F	-	2.0	2.4	V
Junction capacitance	$V_R = 0\text{ V}, f = 1\text{ MHz}$	C_j	-	40	-	pF
Reverse current	$V_R = 5\text{ V}$	I_R	-	-	10	μA

OPTICAL AND ELECTRICAL CHARACTERISTICS ($T_{amb} = 25\text{ }^{\circ}\text{C}$, unless otherwise specified)
VLMTG1300, TRUE GREEN

PARAMETER	TEST CONDITION	SYMBOL	MIN.	TYP.	MAX.	UNIT
Luminous intensity	$I_F = 20\text{ mA}$	I_V	71	-	450	mcd
Dominant wavelength	$I_F = 20\text{ mA}$	λ_d	-	525	-	nm
Peak wavelength	$I_F = 20\text{ mA}$	λ_p	-	530	-	nm
Angle of half intensity	$I_F = 20\text{ mA}$	ϕ	-	± 65	-	deg
Spectral line half width	$I_F = 20\text{ mA}$	$\Delta\lambda$	-	35	-	nm
Forward voltage	$I_F = 20\text{ mA}$	V_F	2.8	3.2	3.6	V
Reverse current	$V_R = 5\text{ V}$	I_R	-	-	10	μA

OPTICAL AND ELECTRICAL CHARACTERISTICS ($T_{amb} = 25\text{ }^{\circ}\text{C}$, unless otherwise specified)
VLMB1300, VLMB1310, BLUE

PARAMETER	TEST CONDITION	SYMBOL	MIN.	TYP.	MAX.	UNIT
Luminous intensity	$I_F = 20\text{ mA}$	I_V	28	-	180	mcd
Dominant wavelength	$I_F = 20\text{ mA}$	λ_d	465	-	475	nm
Peak wavelength	$I_F = 20\text{ mA}$	λ_p	-	468	-	nm
Angle of half intensity	$I_F = 20\text{ mA}$	ϕ	-	± 65	-	deg
Spectral line half width	$I_F = 20\text{ mA}$	$\Delta\lambda$	-	25	-	nm
Forward voltage	$I_F = 20\text{ mA}$	V_F	2.8	-	3.8	V
Reverse current (except VLMB1310)	$V_R = 5\text{ V}$	I_R	-	-	10	μA
Reverse voltage (VLMB1310 only)	$I_R = 10\text{ mA}$	V_R	0.6	-	1.2	V



LUMINOUS INTENSITY CLASSIFICATION		
GROUP	LUMINOUS INTENSITY (mcd)	
	MIN.	MAX.
M	18	28
N	28	45
P	45	71
Q	71	112
R	112	180
S	180	280
T	280	450

Note

- Luminous intensity is tested at a current pulse duration of 25 ms and an accuracy of $\pm 15\%$.
The above type numbers represent the order groups which include only a few brightness groups. Only one group will be shipped on each reel (there will be no mixing of two groups on each reel). In order to ensure availability, single brightness groups will not be orderable.
In a similar manner for colors where wavelength groups are measured and binned, single wavelength groups will be shipped in any one reel.
In order to ensure availability, single wavelength groups will not be orderable.

COLOR CLASSIFICATION			
COLOR	GROUP	DOMINANT WAVELENGTH (nm)	
		MIN.	MAX.
Yellow	H	584.5	587.5
	J	587.5	589.5
	K	589.5	592
	L	592	594.5
	M	594.5	597
Yellow green	C	567.5	570.5
	D	570.5	573.5
	E	573.5	576.5
True green	AP	520	525
	AQ	525	530
	AR	530	535
Blue	AC	465	470
	AD	470	475

Note

- Wavelengths are tested at a current pulse duration of 25 ms and an accuracy of ± 1 nm.

FORWARD VOLTAGE CLASSIFICATION			
COLOR	GROUP	FORWARD VOLTAGE (V)	
		MIN.	MAX.
Yellow	F2	1.8	2.1
	F3	2.1	2.4
Yellow green	4	1.9	2
	5	2	2.1
	6	2.1	2.2
	7	2.2	2.3
	8	2.3	2.4
True green	D7	2.8	3
	D8	3	3.2
	D9	3.2	3.4
	D10	3.4	3.6
Blue	D7	2.8	3
	D8	3	3.2
	D9	3.2	3.4
	D10	3.4	3.6
	D11	3.6	3.8

Note

- Forward voltage is measured with a tolerance of ± 0.1 V.



TYPICAL CHARACTERISTICS ($T_{amb} = 25\text{ }^{\circ}\text{C}$, unless otherwise specified)

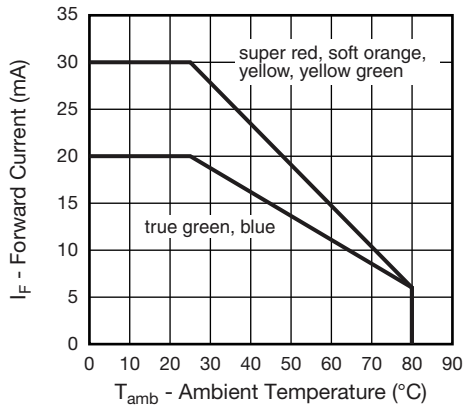

Fig. 1 - Forward Current vs. Ambient Temperature

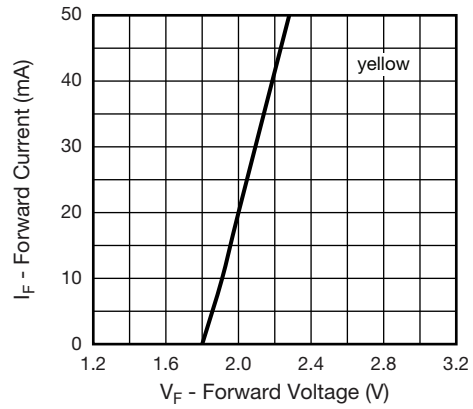

Fig. 4 - Forward Current vs. Forward Voltage (yellow)

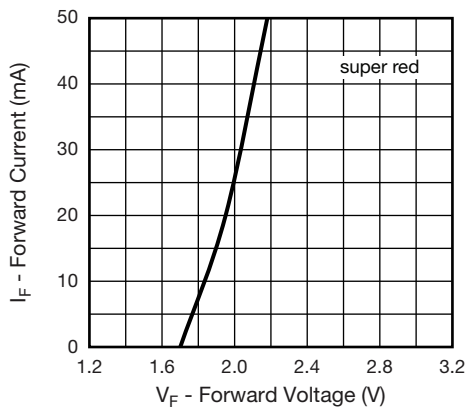

Fig. 2 - Forward Current vs. Forward Voltage (super red)

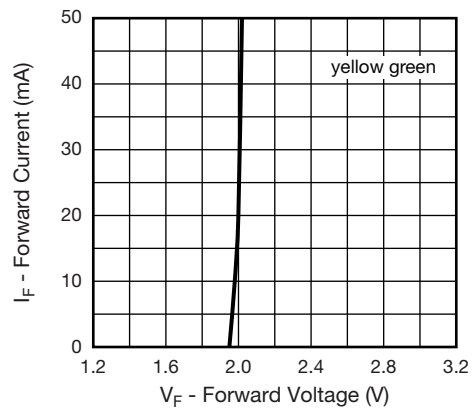

Fig. 5 - Forward Current vs. Forward Voltage (yellow green)

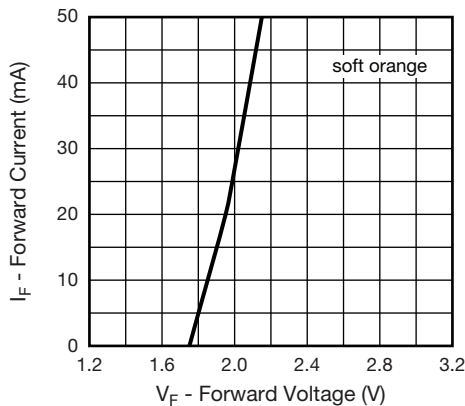

Fig. 3 - Forward Current vs. Forward Voltage (soft orange)

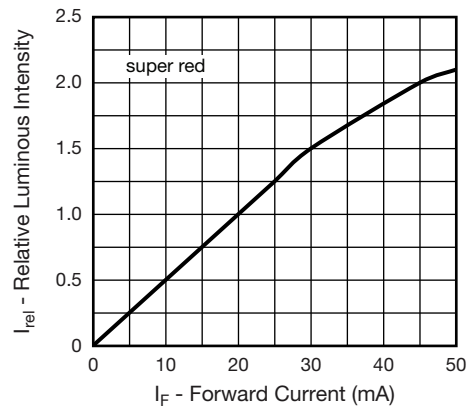

Fig. 6 - Relative Luminous Intensity vs. Forward Current (super red)

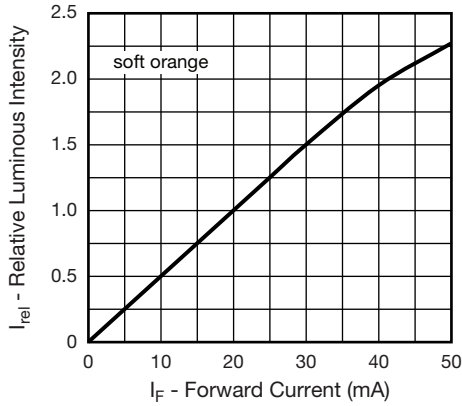

Fig. 7 - Relative Luminous Intensity vs. Forward Current (soft orange)

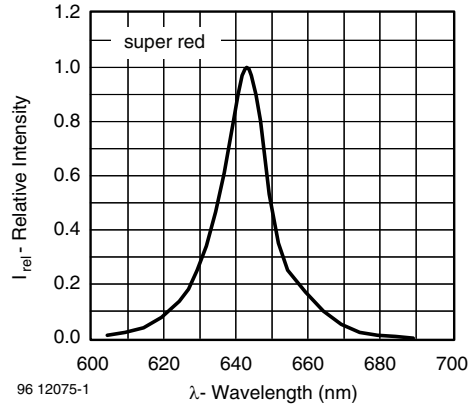

Fig. 10 - Relative Intensity vs. Wavelength (super red)

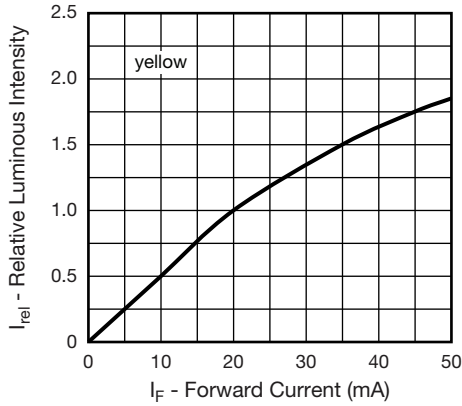

Fig. 8 - Relative Luminous Intensity vs. Forward Current (yellow)

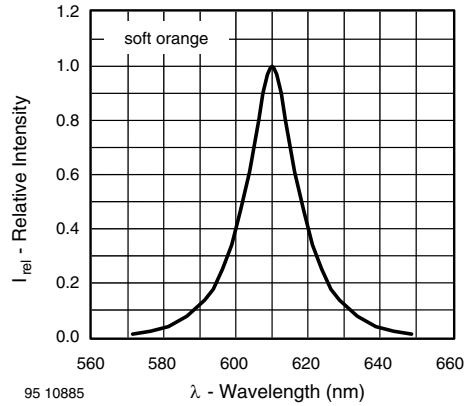

Fig. 11 - Relative Intensity vs. Wavelength (soft orange)

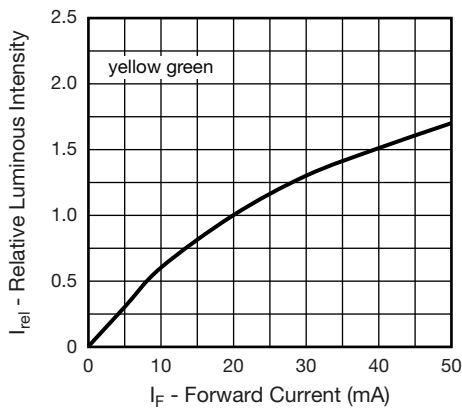

Fig. 9 - Relative Luminous Intensity vs. Forward Current (yellow green)

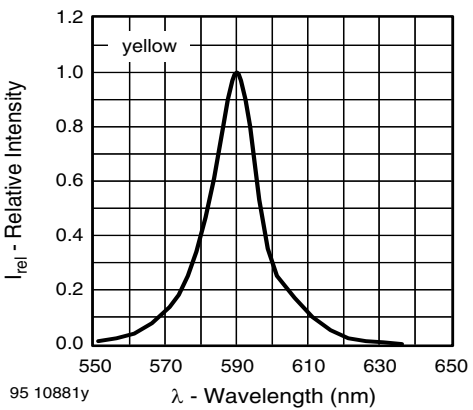

Fig. 12 - Relative Intensity vs. Wavelength (yellow)

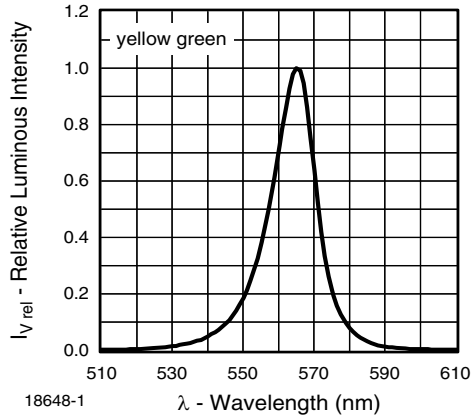

Fig. 13 - Relative Intensity vs. Wavelength (yellow green)

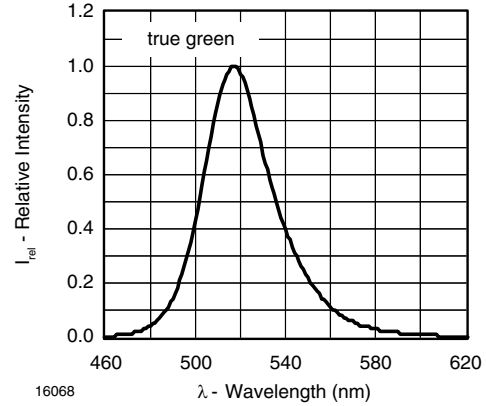

Fig. 16 - Relative Intensity vs. Wavelength (true green)

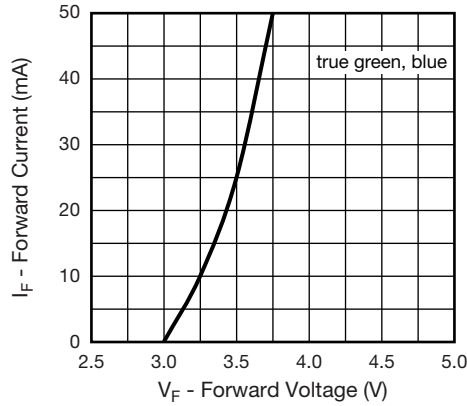

Fig. 14 - Forward Current vs. Forward Voltage (true green, blue)

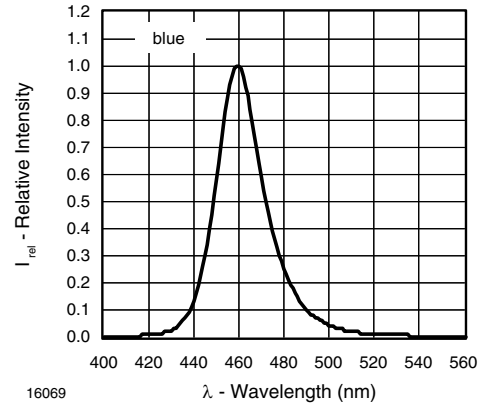

Fig. 17 - Relative Intensity vs. Wavelength (blue)

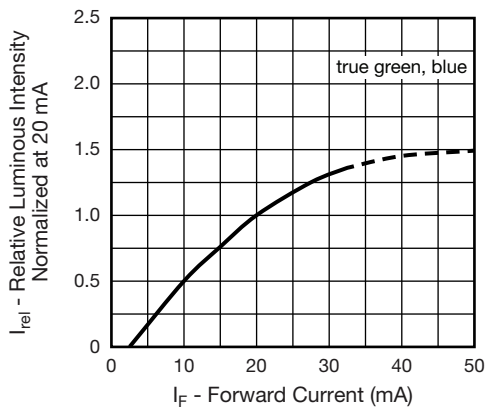

Fig. 15 - Relative Luminous Intensity vs. Forward Current (true green, blue)

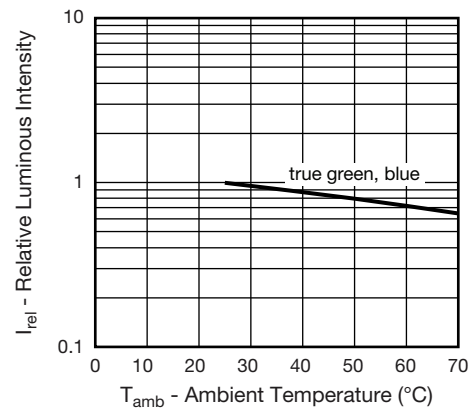

Fig. 18 - Relative Luminous Intensity vs. Ambient Temperature

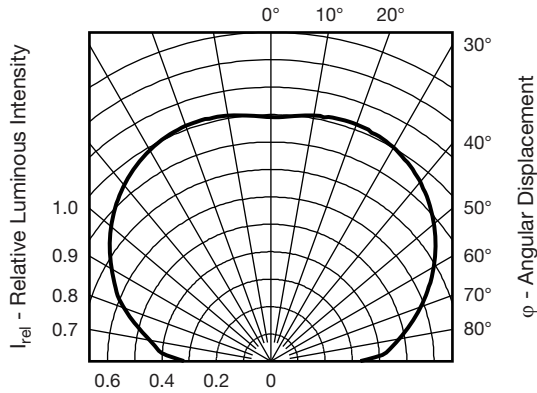
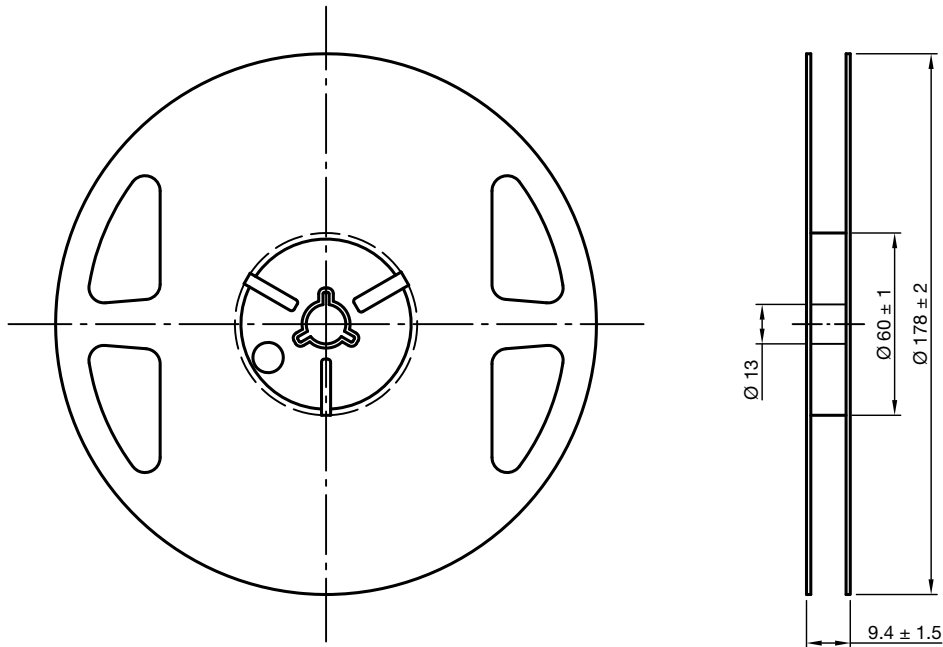
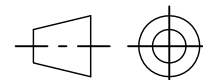

Fig. 19 - Relative Luminous Intensity vs. Angular Displacement

REEL DIMENSIONS in millimeters



Drawing-No.: 9.800-5122.01-4
Issue: 2; 03.11.11
22611



technical drawings
according to DIN
specifications



TAPE DIMENSIONS in millimeters

VLMG 13.., VLMY 13.., VLMO 13.., VLMS 13.., VLMB 13.., VLMB131..

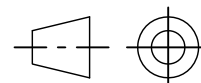
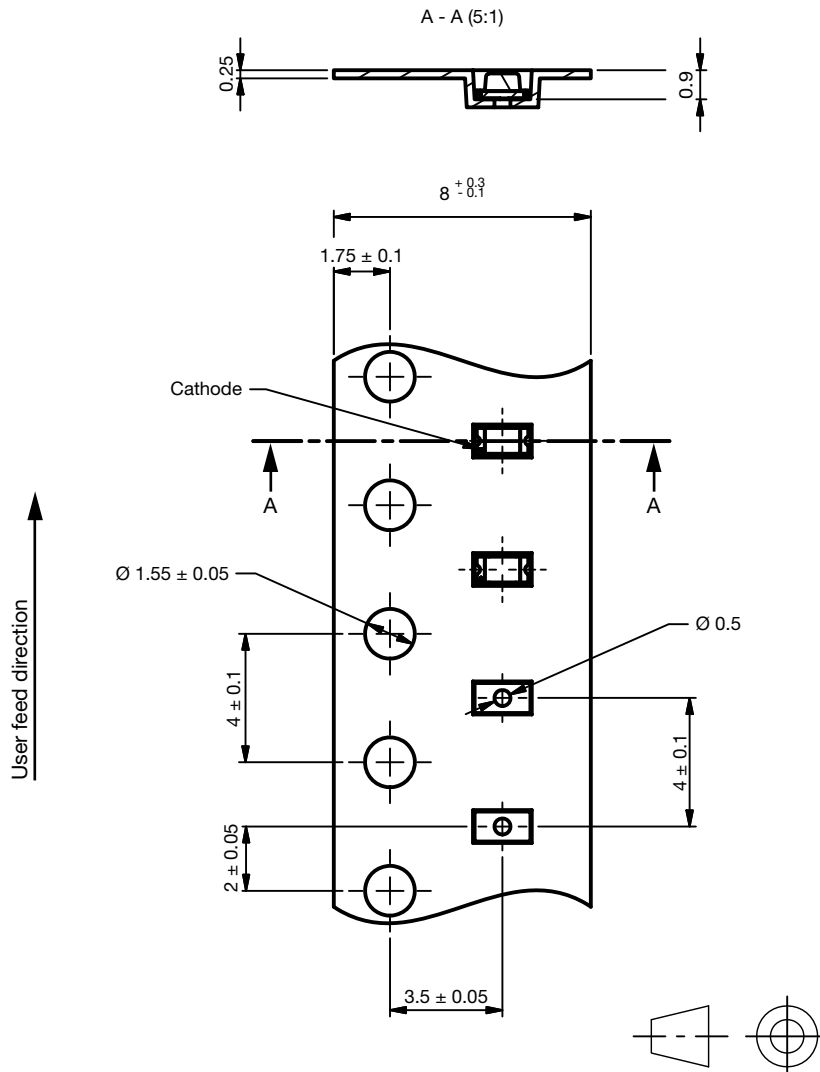

technical drawings according to DIN specifications

Drawing-No.: 9.700-5386.01-4

Issue: 1; 17.10.11

22614



PACKAGE DIMENSIONS in millimeters

VLMG 13.., VLMY 13.., VLMO 13.., VLMS 13..

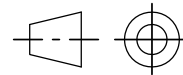
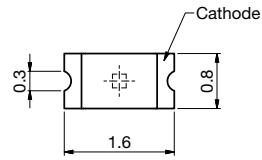
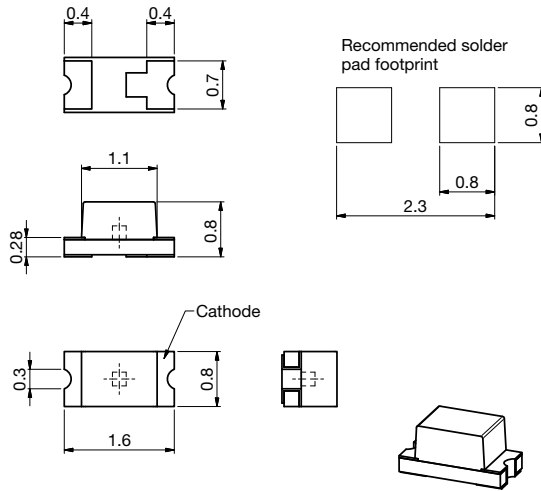

Not indicated tolerances ± 0.2

Drawing-No.: 6.541-5092.01-4

Issue: 1; 17.10.11

22615

technical drawings according to DIN specifications

VLMB 131..

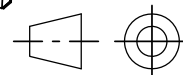
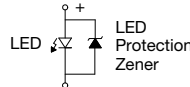
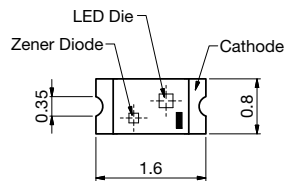
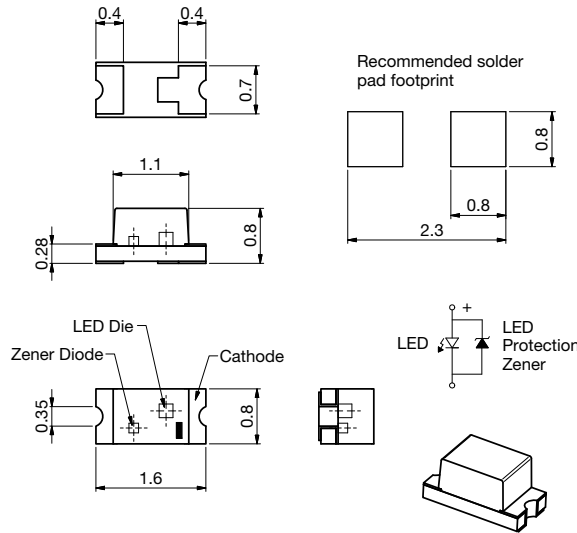

Not indicated tolerances ± 0.2

Drawing-No.: 6.541-5093.01-4

Issue: 1; 17.10.11

22616

technical drawings according to DIN specifications



VLMB 130., VLMTG 130.

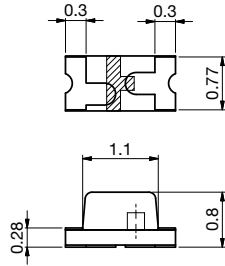

Recommended solder pad footprint

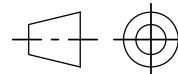
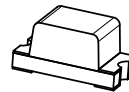
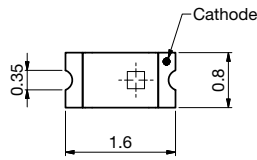
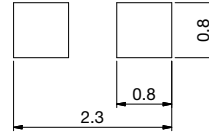

Not indicated tolerances ± 0.2

Drawing-No.: 6.541-5094.01-4
Issue: 1; 17.10.11

22617

technical drawings according to DIN specifications

SOLDERING PROFILE

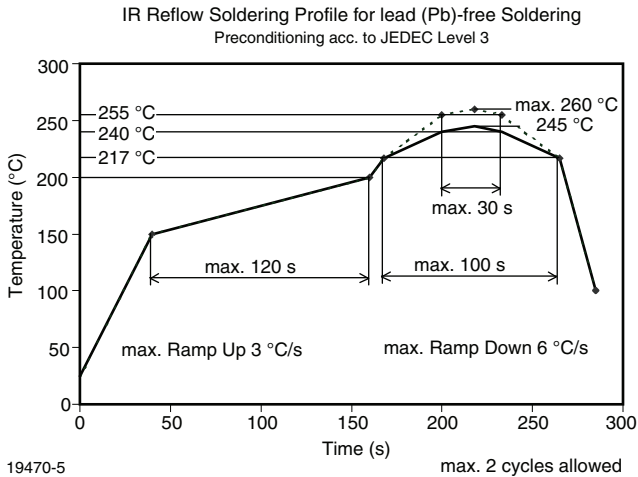
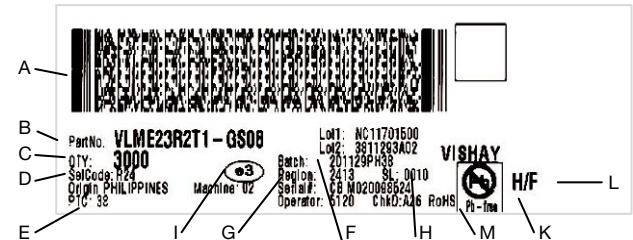

Fig. 20 - Vishay Lead (Pb)-free Reflow Soldering Profile (according to J-STD-020C)

BAR CODE PRODUCT LABEL (example only)



- A) 2D barcode
- B) Vishay part number
- C) Quantity
- D) PTC = selection code (binning)
- E) Code of manufacturing plant
- F) Batch = date code: year/week/plant code
- G) Region code
- H) SL = sales location
- I) Terminations finishing
- K) Lead (Pb)-free symbol
- L) Halogen-free symbol
- M) RoHS symbol



DRY PACKING

The reel is packed in an anti-humidity bag to protect the devices from absorbing moisture during transportation and storage.

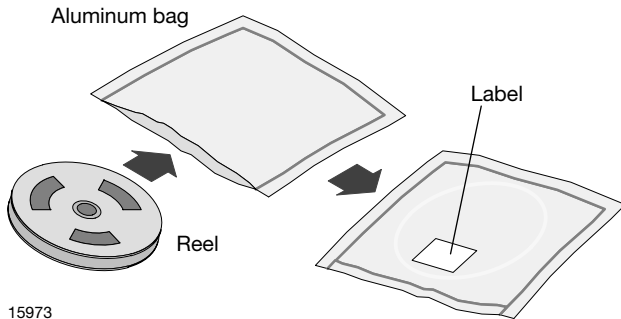

15973

FINAL PACKING

The sealed reel is packed into a cardboard box. A secondary cardboard box is used for shipping purposes.

RECOMMENDED METHOD OF STORAGE

Dry box storage is recommended as soon as the aluminum bag has been opened to prevent moisture absorption. The following conditions should be observed, if dry boxes are not available:

- Storage temperature 10 °C to 30 °C
- Storage humidity ≤ 60 % RH max.

After more than 168 h under these conditions moisture content will be too high for reflow soldering.

In case of moisture absorption, the devices will recover to the former condition by drying under the following condition:

- 192 h at 40 °C + 5 °C/- 0 °C and < 5 % RH (dry air/nitrogen) or
- 96 h at 60 °C + 5 °C and < 5 % RH for all device containers or
- 24 h at 100 °C + 5 °C not suitable for reel or tubes.

An EIA JEDEC standard JESD22-A112 level 3 label is included on all dry bags.

ESD PRECAUTION

Proper storage and handling procedures should be followed to prevent ESD damage to the devices especially when they are removed from the antistatic shielding bag. Electro-static sensitive devices warning labels are on the packaging.

VISHAY SEMICONDUCTORS STANDARD BAR CODE LABELS

The Vishay Semiconductors standard bar code labels are printed at final packing areas. The labels are on each packing unit and contain Vishay Semiconductors specific data.



CAUTION
This bag contains
MOISTURE-SENSITIVE DEVICES

LEVEL

3

1. Shelf life in sealed bag 12 months at <40°C and < 90% relative humidity (RH)

vapor-phase reflow, or equivalent processing (peak package body temp. 260°C) must be:

- a) Mounted within **168 hours** at factory condition of ≤ 30°C/60%RH or
- b) Stored at ≤ 10% RH.

3. Devices require baking before mounting if:

- a) Humidity Indicator Card is >10% when read at 23°C ± 5°C or
- b) 2a or 2b is not met.

4. If baking is required, devices may be baked for:

192 hours at 40°C + 5°C/-0°C and <5%RH (dry air/nitrogen)	or
96 hours at 60±5°C and <5%RH	For all device containers or
24 hours at 100±5°C	Not suitable for reels or tubes

Bag Seal Date: _____
(If blank, see bar code label)

Note: LEVEL defined by EIA JEDEC Standard JESD22-A112

20003

Example of JESD22-A112 Level 3 Label



Disclaimer

ALL PRODUCT, PRODUCT SPECIFICATIONS AND DATA ARE SUBJECT TO CHANGE WITHOUT NOTICE TO IMPROVE RELIABILITY, FUNCTION OR DESIGN OR OTHERWISE.

Vishay Intertechnology, Inc., its affiliates, agents, and employees, and all persons acting on its or their behalf (collectively, "Vishay"), disclaim any and all liability for any errors, inaccuracies or incompleteness contained in any datasheet or in any other disclosure relating to any product.

Vishay makes no warranty, representation or guarantee regarding the suitability of the products for any particular purpose or the continuing production of any product. To the maximum extent permitted by applicable law, Vishay disclaims (i) any and all liability arising out of the application or use of any product, (ii) any and all liability, including without limitation special, consequential or incidental damages, and (iii) any and all implied warranties, including warranties of fitness for particular purpose, non-infringement and merchantability.

Statements regarding the suitability of products for certain types of applications are based on Vishay's knowledge of typical requirements that are often placed on Vishay products in generic applications. Such statements are not binding statements about the suitability of products for a particular application. It is the customer's responsibility to validate that a particular product with the properties described in the product specification is suitable for use in a particular application. Parameters provided in datasheets and/or specifications may vary in different applications and performance may vary over time. All operating parameters, including typical parameters, must be validated for each customer application by the customer's technical experts. Product specifications do not expand or otherwise modify Vishay's terms and conditions of purchase, including but not limited to the warranty expressed therein.

Except as expressly indicated in writing, Vishay products are not designed for use in medical, life-saving, or life-sustaining applications or for any other application in which the failure of the Vishay product could result in personal injury or death. Customers using or selling Vishay products not expressly indicated for use in such applications do so at their own risk. Please contact authorized Vishay personnel to obtain written terms and conditions regarding products designed for such applications.

No license, express or implied, by estoppel or otherwise, to any intellectual property rights is granted by this document or by any conduct of Vishay. Product names and markings noted herein may be trademarks of their respective owners.

Material Category Policy

Vishay Intertechnology, Inc. hereby certifies that all its products that are identified as RoHS-Compliant fulfill the definitions and restrictions defined under Directive 2011/65/EU of The European Parliament and of the Council of June 8, 2011 on the restriction of the use of certain hazardous substances in electrical and electronic equipment (EEE) - recast, unless otherwise specified as non-compliant.

Please note that some Vishay documentation may still make reference to RoHS Directive 2002/95/EC. We confirm that all the products identified as being compliant to Directive 2002/95/EC conform to Directive 2011/65/EU.

Vishay Intertechnology, Inc. hereby certifies that all its products that are identified as Halogen-Free follow Halogen-Free requirements as per JEDEC JS709A standards. Please note that some Vishay documentation may still make reference to the IEC 61249-2-21 definition. We confirm that all the products identified as being compliant to IEC 61249-2-21 conform to JEDEC JS709A standards.



Компания «ЭлектроПласт» предлагает заключение долгосрочных отношений при поставках импортных электронных компонентов на взаимовыгодных условиях!

Наши преимущества:

- Оперативные поставки широкого спектра электронных компонентов отечественного и импортного производства напрямую от производителей и с крупнейших мировых складов;
- Поставка более 17-ти миллионов наименований электронных компонентов;
- Поставка сложных, дефицитных, либо снятых с производства позиций;
- Оперативные сроки поставки под заказ (от 5 рабочих дней);
- Экспресс доставка в любую точку России;
- Техническая поддержка проекта, помощь в подборе аналогов, поставка прототипов;
- Система менеджмента качества сертифицирована по Международному стандарту ISO 9001;
- Лицензия ФСБ на осуществление работ с использованием сведений, составляющих государственную тайну;
- Поставка специализированных компонентов (Xilinx, Altera, Analog Devices, Intersil, Interpoint, Microsemi, Aeroflex, Peregrine, Syfer, Eurofarad, Texas Instrument, Miteq, Cobham, E2V, MA-COM, Hittite, Mini-Circuits, General Dynamics и др.);

Помимо этого, одним из направлений компании «ЭлектроПласт» является направление «Источники питания». Мы предлагаем Вам помощь Конструкторского отдела:

- Подбор оптимального решения, техническое обоснование при выборе компонента;
- Подбор аналогов;
- Консультации по применению компонента;
- Поставка образцов и прототипов;
- Техническая поддержка проекта;
- Защита от снятия компонента с производства.



Как с нами связаться

Телефон: 8 (812) 309 58 32 (многоканальный)

Факс: 8 (812) 320-02-42

Электронная почта: org@eplast1.ru

Адрес: 198099, г. Санкт-Петербург, ул. Калинина, дом 2, корпус 4, литера А.