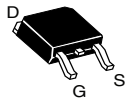
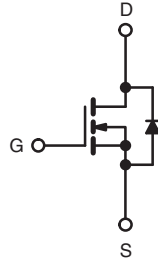
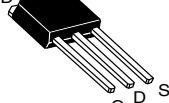

Power MOSFET

| PRODUCT SUMMARY | |
|---------------------------|----------------------------|
| V_{DS} (V) | 200 |
| $R_{DS(on)}$ (Ω) | $V_{GS} = 10\text{ V}$ 1.5 |
| Q_g (Max.) (nC) | 8.2 |
| Q_{gs} (nC) | 1.8 |
| Q_{gd} (nC) | 4.5 |
| Configuration | Single |

 DPAK
(TO-252)

 IPAK
(TO-251)

N-Channel MOSFET

FEATURES

- Dynamic dV/dt Rating
- Repetitive Avalanche Rated
- Surface Mount (IRFR210, SiHFR210)
- Straight Lead (IRFU210, SiHFU210)
- Available in Tape and Reel
- Fast Switching
- Ease of Paralleling
- Material categorization: For definitions of compliance please see www.vishay.com/doc?99912



RoHS
COMPLIANT
HALOGEN
FREE
Available

DESCRIPTION

Third generation power MOSFETs from Vishay provide the designer with the best combination of fast switching, ruggedized device design, low on-resistance and cost-effectiveness.

The DPAK is designed for surface mounting using vapor phase, infrared, or wave soldering techniques. The straight lead version (IRFU, SiHFU series) is for through-hole mounting applications. Power dissipation levels up to 1.5 W are possible in typical surface mount applications.

| ORDERING INFORMATION | | | | | |
|---------------------------------|---------------|------------------------------|---------------------------|------------------------------|---------------|
| Package | DPAK (TO-252) | DPAK (TO-252) | DPAK (TO-252) | DPAK (TO-252) | IPAK (TO-251) |
| Lead (Pb)-free and Halogen-free | SiHFR210-GE3 | SiHFR210TRL-GE3 ^a | - | SiHFR210TRR-GE3 ^a | SiHFU210-GE3 |
| Lead (Pb)-free | IRFR210PbF | IRFR210TRLPbF ^a | IRFR210TRPbF ^a | - | IRFU210PbF |
| | SiHFR210-E3 | SiHFR210TL-E3 ^a | SiHFR210T-E3 ^a | - | SiHFU210-E3 |

Note

- a. See device orientation.

| ABSOLUTE MAXIMUM RATINGS ($T_C = 25\text{ }^\circ\text{C}$, unless otherwise noted) | | | | |
|---|----------------------------------|-----------------------------------|---------------|---------------------|
| PARAMETER | SYMBOL | | LIMIT | UNIT |
| Drain-Source Voltage | V_{DS} | | 200 | V |
| Gate-Source Voltage | V_{GS} | | ± 20 | |
| Continuous Drain Current | V_{GS} at 10 V | $T_C = 25\text{ }^\circ\text{C}$ | 2.6 | A |
| | | $T_C = 100\text{ }^\circ\text{C}$ | 1.7 | |
| Pulsed Drain Current ^a | I_{DM} | | 10 | W/ $^\circ\text{C}$ |
| Linear Derating Factor | | | 0.20 | |
| Linear Derating Factor (PCB Mount) ^e | | | 0.020 | |
| Single Pulse Avalanche Energy ^b | E_{AS} | | 95 | mJ |
| Avalanche Current ^a | I_{AR} | | 2.7 | A |
| Repetitive Avalanche Energy ^a | E_{AR} | | 2.5 | mJ |
| Maximum Power Dissipation | $T_C = 25\text{ }^\circ\text{C}$ | | 25 | W |
| | $T_A = 25\text{ }^\circ\text{C}$ | | 2.5 | |
| Peak Diode Recovery dV/dt ^c | dV/dt | | 5.0 | V/ns |
| Operating Junction and Storage Temperature Range | T_J, T_{stg} | | - 55 to + 150 | $^\circ\text{C}$ |
| Soldering Recommendations (Peak Temperature) ^d | for 10 s | | 260 | |

Notes



- a. Repetitive rating; pulse width limited by maximum junction temperature (see fig. 11).
 b. $V_{DD} = 50\text{ V}$, starting $T_J = 25\text{ }^\circ\text{C}$, $L = 28\text{ mH}$, $R_g = 25\text{ }\Omega$, $I_{AS} = 2.6\text{ A}$ (see fig. 12).
 c. $I_{SD} \leq 2.6\text{ A}$, $dI/dt \leq 70\text{ A}/\mu\text{s}$, $V_{DD} \leq V_{DS}$, $T_J \leq 150\text{ }^\circ\text{C}$.
 d. 1.6 mm from case.
 e. When mounted on 1" square PCB (FR-4 or G-10 material).



| THERMAL RESISTANCE RATINGS | | | | | |
|--|------------|------|------|------|------|
| PARAMETER | SYMBOL | MIN. | TYP. | MAX. | UNIT |
| Maximum Junction-to-Ambient | R_{thJA} | - | - | 110 | °C/W |
| Maximum Junction-to-Ambient (PCB Mount) ^a | R_{thJA} | - | - | 50 | |
| Maximum Junction-to-Case (Drain) | R_{thJC} | - | - | 5.0 | |

Note

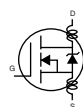
a. When mounted on 1" square PCB (FR-4 or G-10 material).

| SPECIFICATIONS ($T_J = 25\text{ }^\circ\text{C}$, unless otherwise noted) | | | | | | | |
|---|---------------------|---|--|------|------|-----------|---------------------|
| PARAMETER | SYMBOL | TEST CONDITIONS | | MIN. | TYP. | MAX. | UNIT |
| Static | | | | | | | |
| Drain-Source Breakdown Voltage | V_{DS} | $V_{GS} = 0\text{ V}, I_D = 250\text{ }\mu\text{A}$ | | 200 | - | - | V |
| V_{DS} Temperature Coefficient | $\Delta V_{DS}/T_J$ | Reference to $25\text{ }^\circ\text{C}$, $I_D = 1\text{ mA}$ | | - | 0.30 | - | V/ $^\circ\text{C}$ |
| Gate-Source Threshold Voltage | $V_{GS(th)}$ | $V_{DS} = V_{GS}, I_D = 250\text{ }\mu\text{A}$ | | 2.0 | - | 4.0 | V |
| Gate-Source Leakage | I_{GSS} | $V_{GS} = \pm 20\text{ V}$ | | - | - | ± 100 | nA |
| Zero Gate Voltage Drain Current | I_{DSS} | $V_{DS} = 200\text{ V}, V_{GS} = 0\text{ V}$ | | - | - | 25 | μA |
| | | $V_{DS} = 160\text{ V}, V_{GS} = 0\text{ V}, T_J = 125\text{ }^\circ\text{C}$ | | - | - | 250 | |
| Drain-Source On-State Resistance | $R_{DS(on)}$ | $V_{GS} = 10\text{ V}$ | $I_D = 1.6\text{ A}^b$ | - | - | 1.5 | Ω |
| Forward Transconductance | g_{fs} | $V_{DS} = 50\text{ V}, I_D = 1.6\text{ A}^b$ | | 0.80 | - | - | S |
| Dynamic | | | | | | | |
| Input Capacitance | C_{iss} | $V_{GS} = 0\text{ V}, V_{DS} = 25\text{ V}, f = 1.0\text{ MHz}$, see fig. 5 | | - | 140 | - | pF |
| Output Capacitance | C_{oss} | | | - | 53 | - | |
| Reverse Transfer Capacitance | C_{rss} | | | - | 15 | - | |
| Total Gate Charge | Q_g | $V_{GS} = 10\text{ V}$ | $I_D = 3.3\text{ A}, V_{DS} = 160\text{ V}$, see fig. 6 and 13 ^b | - | - | 8.2 | nC |
| Gate-Source Charge | Q_{gs} | | | - | - | 1.8 | |
| Gate-Drain Charge | Q_{gd} | | | - | - | 4.5 | |
| Turn-On Delay Time | $t_{d(on)}$ | $V_{DD} = 100\text{ V}, I_D = 3.3\text{ A}, R_g = 24\text{ }\Omega, R_D = 30\text{ }\Omega$, see fig. 10 ^b | | - | 8.2 | - | ns |
| Rise Time | t_r | | | - | 17 | - | |
| Turn-Off Delay Time | $t_{d(off)}$ | | | - | 14 | - | |
| Fall Time | t_f | | | - | 8.9 | - | |
| Internal Drain Inductance | L_D | Between lead, 6 mm (0.25") from package and center of die contact  | | - | 4.5 | - | nH |
| Internal Source Inductance | L_S | | | - | 7.5 | - | |
| Drain-Source Body Diode Characteristics | | | | | | | |
| Continuous Source-Drain Diode Current | I_S | MOSFET symbol showing the integral reverse p - n junction diode  | | - | - | 2.6 | A |
| Pulsed Diode Forward Current ^a | I_{SM} | | | - | - | 10 | |
| Body Diode Voltage | V_{SD} | $T_J = 25\text{ }^\circ\text{C}, I_S = 2.6\text{ A}, V_{GS} = 0\text{ V}^b$ | | - | - | 2.0 | V |
| Body Diode Reverse Recovery Time | t_{rr} | $T_J = 25\text{ }^\circ\text{C}, I_F = 3.3\text{ A}, dI/dt = 100\text{ A}/\mu\text{s}^b$ | | - | 150 | 310 | ns |
| Body Diode Reverse Recovery Charge | Q_{rr} | | | - | 0.60 | 1.4 | μC |
| Forward Turn-On Time | t_{on} | Intrinsic turn-on time is negligible (turn-on is dominated by L_S and L_D) | | | | | |

Notes

- a. Repetitive rating; pulse width limited by maximum junction temperature (see fig. 11).
- b. Pulse width $\leq 300\text{ }\mu\text{s}$; duty cycle $\leq 2\%$.



TYPICAL CHARACTERISTICS (25 °C, unless otherwise noted)

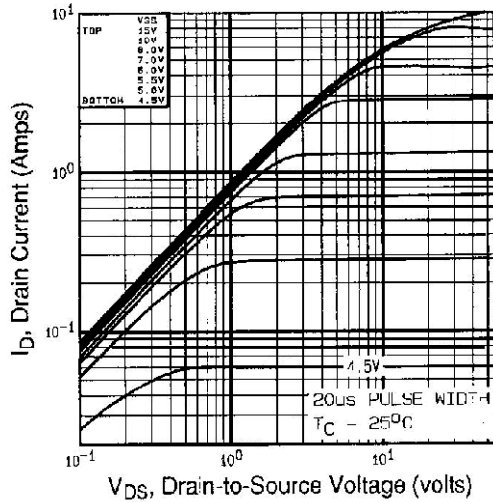

Fig. 1 - Typical Output Characteristics, $T_C = 25\text{ }^\circ\text{C}$

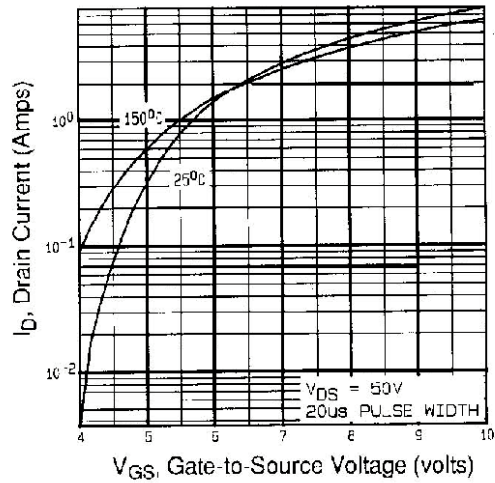

Fig. 3 - Typical Transfer Characteristics

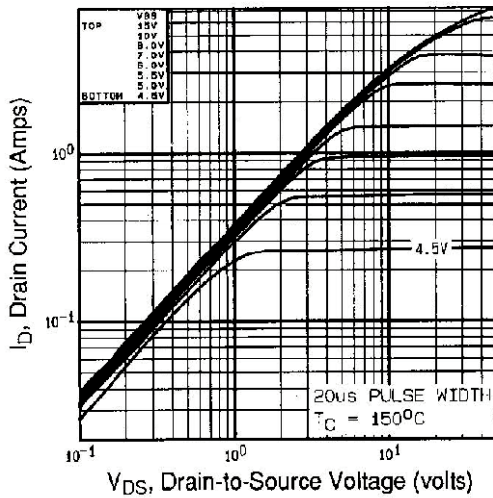

Fig. 2 - Typical Output Characteristics, $T_C = 150\text{ }^\circ\text{C}$

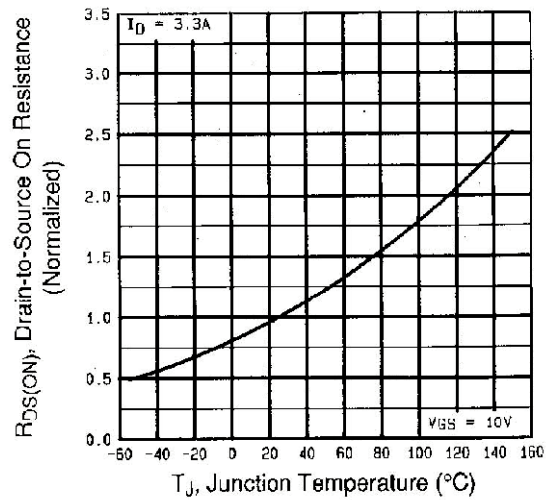

Fig. 4 - Normalized On-Resistance vs. Temperature

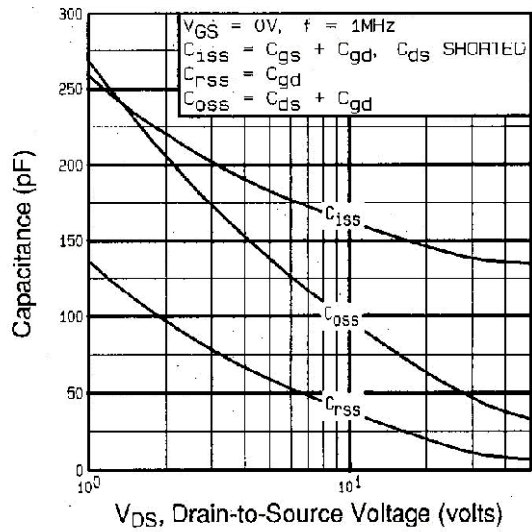

Fig. 5 - Typical Capacitance vs. Drain-to-Source Voltage

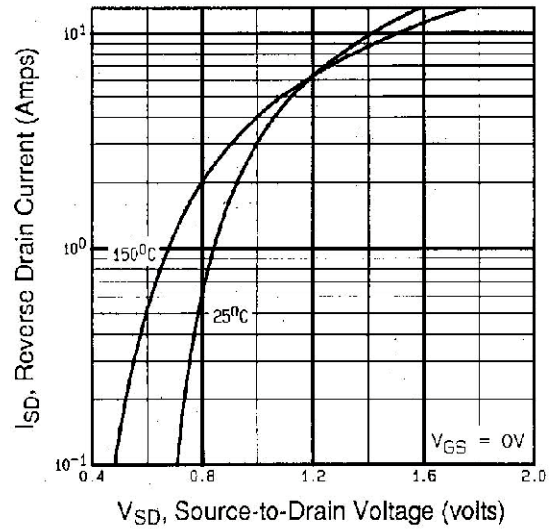

Fig. 7 - Typical Source-Drain Diode Forward Voltage

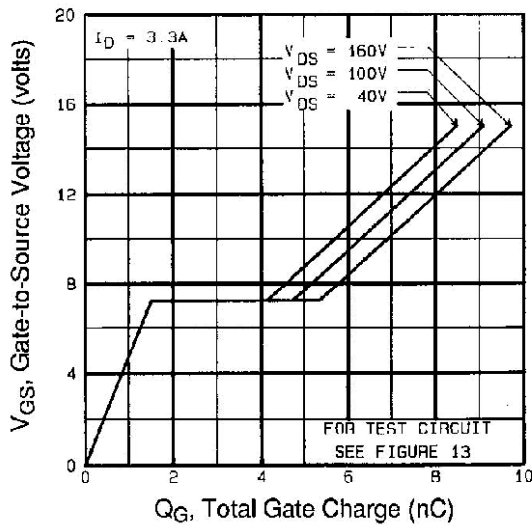

Fig. 6 - Typical Gate Charge vs. Gate-to-Source Voltage

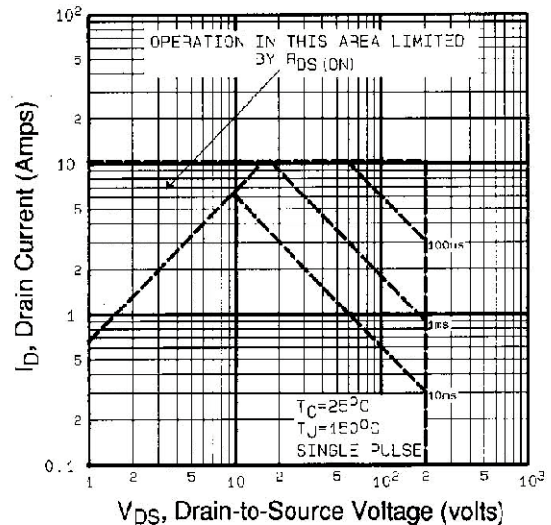

Fig. 8 - Maximum Safe Operating Area

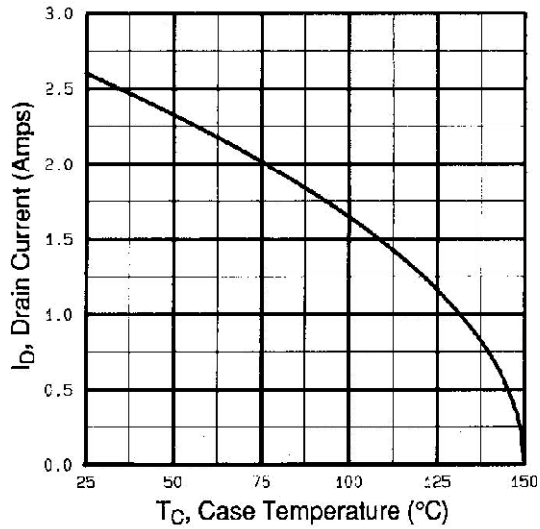

Fig. 9 - Maximum Drain Current vs. Case Temperature

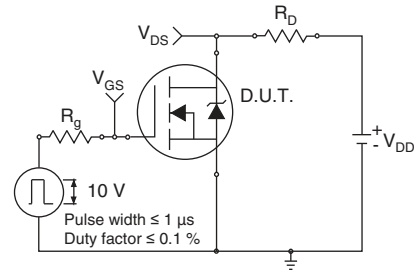

Fig. 10a - Switching Time Test Circuit

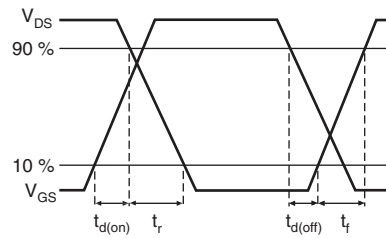

Fig. 10b - Switching Time Waveforms

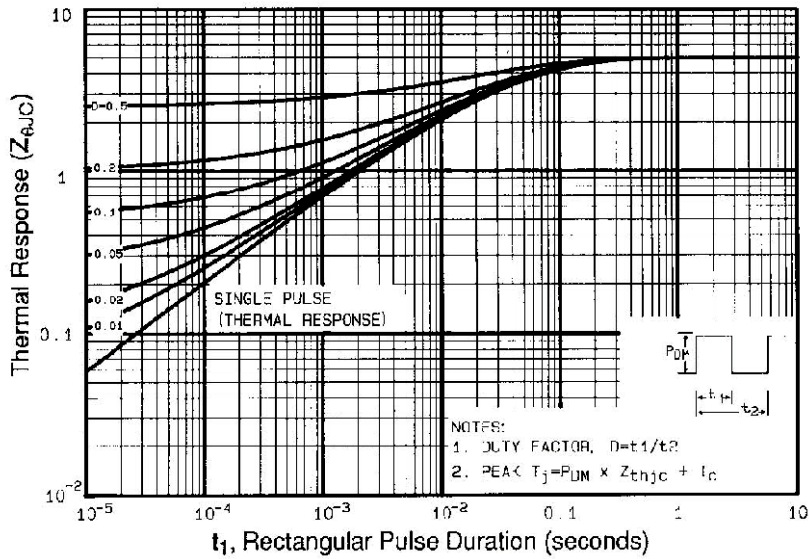

Fig. 11 - Maximum Effective Transient Thermal Impedance, Junction-to-Case

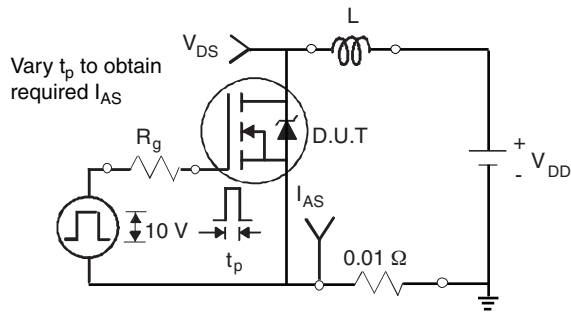

Fig. 12a - Unclamped Inductive Test Circuit



Fig. 12b - Unclamped Inductive Waveforms

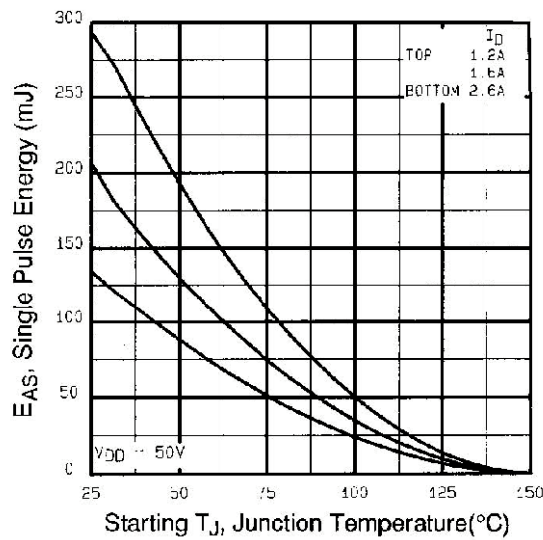

Fig. 12c - Maximum Avalanche Energy vs. Drain Current

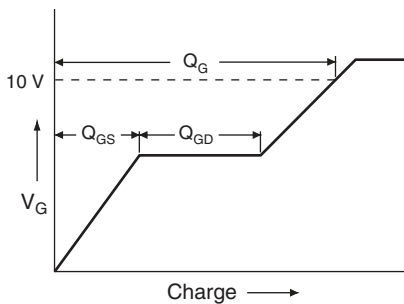

Fig. 13a - Basic Gate Charge Waveform

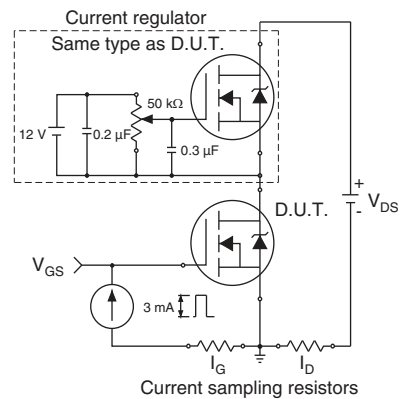
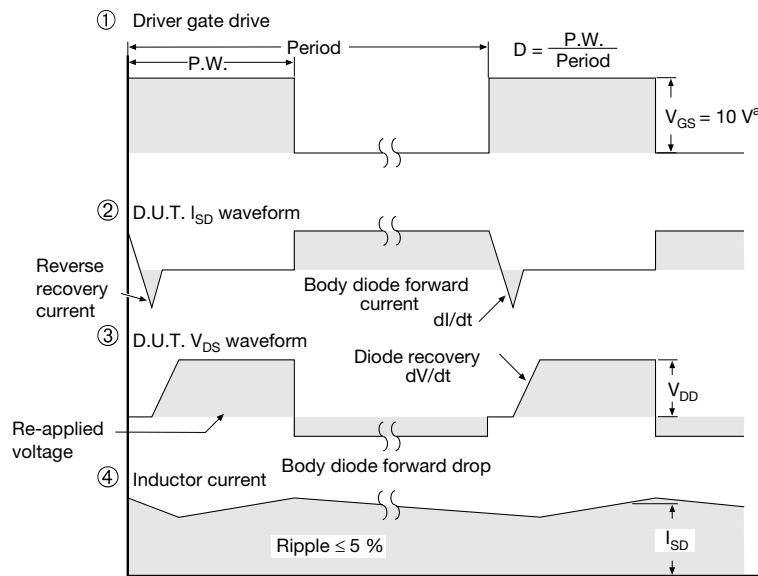
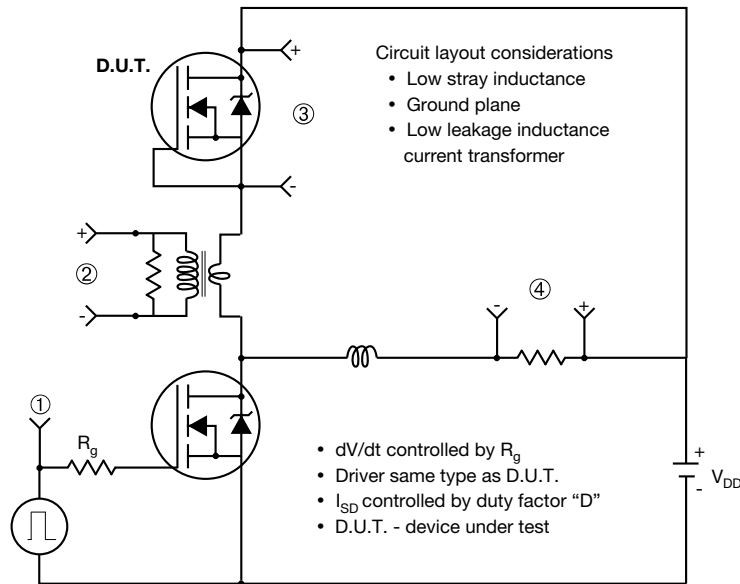

Fig. 13b - Gate Charge Test Circuit

Peak Diode Recovery dV/dt Test Circuit



Note

a. $V_{GS} = 5 V$ for logic level devices

Fig. 14 - For N-Channel

Vishay Siliconix maintains worldwide manufacturing capability. Products may be manufactured at one of several qualified locations. Reliability data for Silicon Technology and Package Reliability represent a composite of all qualified locations. For related documents such as package/tape drawings, part marking, and reliability data, see www.vishay.com/ppg?91268.

TO-252AA (HIGH VOLTAGE)

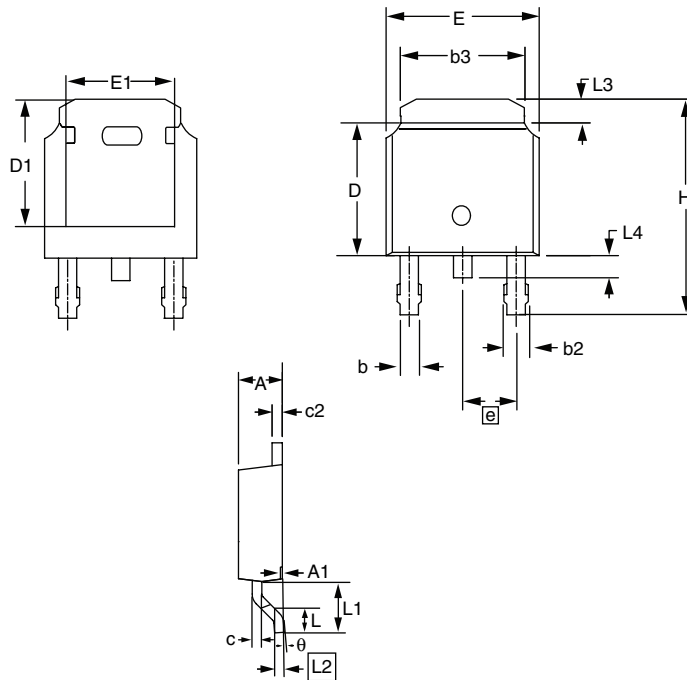

| DIM. | MILLIMETERS | | INCHES | |
|------|-------------|-------|-----------|-------|
| | MIN. | MAX. | MIN. | MAX. |
| E | 6.40 | 6.73 | 0.252 | 0.265 |
| L | 1.40 | 1.77 | 0.055 | 0.070 |
| L1 | 2.743 REF | | 0.108 REF | |
| L2 | 0.508 BSC | | 0.020 BSC | |
| L3 | 0.89 | 1.27 | 0.035 | 0.050 |
| L4 | 0.64 | 1.01 | 0.025 | 0.040 |
| D | 6.00 | 6.22 | 0.236 | 0.245 |
| H | 9.40 | 10.40 | 0.370 | 0.409 |
| b | 0.64 | 0.88 | 0.025 | 0.035 |
| b2 | 0.77 | 1.14 | 0.030 | 0.045 |
| b3 | 5.21 | 5.46 | 0.205 | 0.215 |
| e | 2.286 BSC | | 0.090 BSC | |
| A | 2.20 | 2.38 | 0.087 | 0.094 |
| A1 | 0.00 | 0.13 | 0.000 | 0.005 |
| c | 0.45 | 0.60 | 0.018 | 0.024 |
| c2 | 0.45 | 0.58 | 0.018 | 0.023 |
| D1 | 5.30 | - | 0.209 | - |
| E1 | 4.40 | - | 0.173 | - |
| θ | 0' | 10' | 0' | 10' |

ECN: S-81965-Rev. A, 15-Sep-08
DWG: 5973

Notes

1. Package body sizes exclude mold flash, protrusion or gate burrs. Mold flash, protrusion or gate burrs shall not exceed 0.10 mm per side.
2. Package body sizes determined at the outermost extremes of the plastic body exclusive of mold flash, gate burrs and interlead flash, but including any mismatch between the top and bottom of the plastic body.
3. The package top may be smaller than the package bottom.
4. Dimension "b" does not include dambar protrusion. Allowable dambar protrusion shall be 0.10 mm total in excess of "b" dimension at maximum material condition. The dambar cannot be located on the lower radius of the foot.

RECOMMENDED MINIMUM PADS FOR DPAK (TO-252)

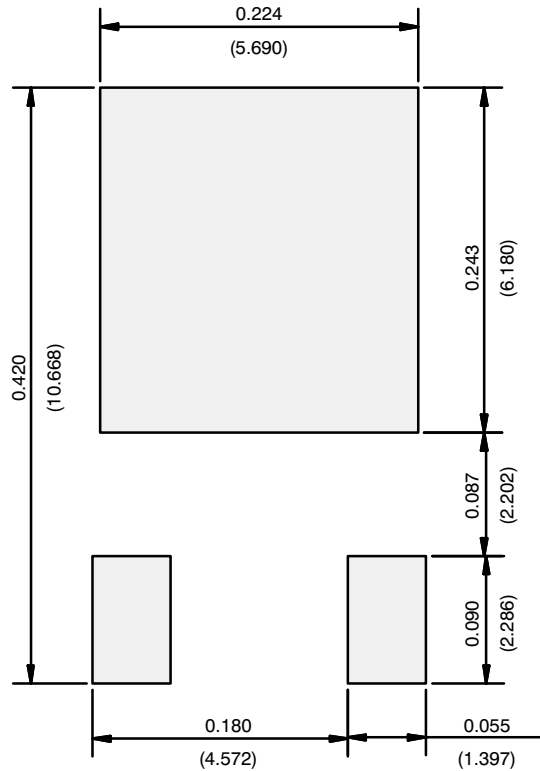

Recommended Minimum Pads
Dimensions in Inches/(mm)

[Return to Index](#)



Disclaimer

ALL PRODUCT, PRODUCT SPECIFICATIONS AND DATA ARE SUBJECT TO CHANGE WITHOUT NOTICE TO IMPROVE RELIABILITY, FUNCTION OR DESIGN OR OTHERWISE.

Vishay Intertechnology, Inc., its affiliates, agents, and employees, and all persons acting on its or their behalf (collectively, "Vishay"), disclaim any and all liability for any errors, inaccuracies or incompleteness contained in any datasheet or in any other disclosure relating to any product.

Vishay makes no warranty, representation or guarantee regarding the suitability of the products for any particular purpose or the continuing production of any product. To the maximum extent permitted by applicable law, Vishay disclaims (i) any and all liability arising out of the application or use of any product, (ii) any and all liability, including without limitation special, consequential or incidental damages, and (iii) any and all implied warranties, including warranties of fitness for particular purpose, non-infringement and merchantability.

Statements regarding the suitability of products for certain types of applications are based on Vishay's knowledge of typical requirements that are often placed on Vishay products in generic applications. Such statements are not binding statements about the suitability of products for a particular application. It is the customer's responsibility to validate that a particular product with the properties described in the product specification is suitable for use in a particular application. Parameters provided in datasheets and/or specifications may vary in different applications and performance may vary over time. All operating parameters, including typical parameters, must be validated for each customer application by the customer's technical experts. Product specifications do not expand or otherwise modify Vishay's terms and conditions of purchase, including but not limited to the warranty expressed therein.

Except as expressly indicated in writing, Vishay products are not designed for use in medical, life-saving, or life-sustaining applications or for any other application in which the failure of the Vishay product could result in personal injury or death. Customers using or selling Vishay products not expressly indicated for use in such applications do so at their own risk. Please contact authorized Vishay personnel to obtain written terms and conditions regarding products designed for such applications.

No license, express or implied, by estoppel or otherwise, to any intellectual property rights is granted by this document or by any conduct of Vishay. Product names and markings noted herein may be trademarks of their respective owners.

Material Category Policy

Vishay Intertechnology, Inc. hereby certifies that all its products that are identified as RoHS-Compliant fulfill the definitions and restrictions defined under Directive 2011/65/EU of The European Parliament and of the Council of June 8, 2011 on the restriction of the use of certain hazardous substances in electrical and electronic equipment (EEE) - recast, unless otherwise specified as non-compliant.

Please note that some Vishay documentation may still make reference to RoHS Directive 2002/95/EC. We confirm that all the products identified as being compliant to Directive 2002/95/EC conform to Directive 2011/65/EU.

Vishay Intertechnology, Inc. hereby certifies that all its products that are identified as Halogen-Free follow Halogen-Free requirements as per JEDEC JS709A standards. Please note that some Vishay documentation may still make reference to the IEC 61249-2-21 definition. We confirm that all the products identified as being compliant to IEC 61249-2-21 conform to JEDEC JS709A standards.



Компания «ЭлектроПласт» предлагает заключение долгосрочных отношений при поставках импортных электронных компонентов на взаимовыгодных условиях!

Наши преимущества:

- Оперативные поставки широкого спектра электронных компонентов отечественного и импортного производства напрямую от производителей и с крупнейших мировых складов;
- Поставка более 17-ти миллионов наименований электронных компонентов;
- Поставка сложных, дефицитных, либо снятых с производства позиций;
- Оперативные сроки поставки под заказ (от 5 рабочих дней);
- Экспресс доставка в любую точку России;
- Техническая поддержка проекта, помощь в подборе аналогов, поставка прототипов;
- Система менеджмента качества сертифицирована по Международному стандарту ISO 9001;
- Лицензия ФСБ на осуществление работ с использованием сведений, составляющих государственную тайну;
- Поставка специализированных компонентов (Xilinx, Altera, Analog Devices, Intersil, Interpoint, Microsemi, Aeroflex, Peregrine, Syfer, Eurofarad, Texas Instrument, Miteq, Cobham, E2V, MA-COM, Hittite, Mini-Circuits, General Dynamics и др.);

Помимо этого, одним из направлений компании «ЭлектроПласт» является направление «Источники питания». Мы предлагаем Вам помощь Конструкторского отдела:

- Подбор оптимального решения, техническое обоснование при выборе компонента;
- Подбор аналогов;
- Консультации по применению компонента;
- Поставка образцов и прототипов;
- Техническая поддержка проекта;
- Защита от снятия компонента с производства.



Как с нами связаться

Телефон: 8 (812) 309 58 32 (многоканальный)

Факс: 8 (812) 320-02-42

Электронная почта: org@eplast1.ru

Адрес: 198099, г. Санкт-Петербург, ул. Калинина, дом 2, корпус 4, литера А.