



SPECIFICATION FOR LCD MODULE

Customer : _____

Product Model: RX050A-05

Sample code: _____

| Designed by | Checked by | Approved by |
|-------------|------------|-------------|
| | | |

Final Approval by Customer

| | |
|--|---|
| <input type="checkbox"/> LCM Machinery OK Checked By _____ | <input type="checkbox"/> LCM OK |
| <input type="checkbox"/> LCM Display OK Checked By _____ | <input type="checkbox"/> NG , Problem survey: Approved By _____ |

※The specification of "TBD" should refer to the measured value of sample . If there is difference between the design specification and measured value, we naturally shall negotiate and agree to solution with customer.

Contents

| | |
|--|-----------|
| 1. General Specifications | 1 |
| 2. Pin Assignment | 2 |
| 3. Operation Specifications | 4 |
| 3.1. Absolute Maximum Ratings | 4 |
| 3.1.1. Typical Operation Conditions | 4 |
| 3.1.2. Backlight Driving Conditions | 5 |
| 3.2. Power Sequence | 5 |
| 3.3. Timing Characteristics | 6 |
| 3.3.1. Sync Mode | 6 |
| 3.3.2. De Mode..... | 8 |
| 3.3.3. Input Setup Timing Requirement..... | 错误！未定义书签。 |
| 4. Optical Specifications | 9 |
| 5. Reliability Test Items | 13 |
| 6. General Precautions | 14 |
| 6.1. Safety | 14 |
| 6.2. Handling..... | 14 |
| 6.3. Static Electricity..... | 14 |
| 6.4. Storage | 14 |
| 6.5. Cleaning..... | 14 |
| 7. Mechanical Drawing | 15 |

1. General Specifications

| No. | Item | Specification | Remark |
|-----|-----------------------------|--------------------------------|--------|
| 1 | LCD size | 5.0 inch(Diagonal) | |
| 2 | Driver element | a-Si TFT active matrix | |
| 3 | Resolution | 800 × 3(RGB) × 480 | |
| 4 | Display mode | Normally White, Transmissive | |
| 5 | Dot pitch | 0.135(W) × 0.135(H) mm | |
| 6 | Active area | 108(W) × 64.8 (H) mm | |
| 7 | Module size | 120.7(W) × 75.8(H) × 3.1(D) mm | Note 1 |
| 8 | Surface treatment | Anti-Glare | |
| 9 | Color arrangement | RGB-stripe | |
| 10 | Interface | Digital | |
| 11 | Backlight power consumption | TBD | |
| 12 | Panel power consumption | TBD | |
| 13 | Weight | TBD | |

Note 1: Refer to Mechanical Drawing.

2. Pin Assignment

| | | |
|-----------|-------------|------------------------------------|
| 1 | GLED | GND for LED |
| 2 | VLED | Power for LED |
| 3 | GND | Ground |
| 4 | VDD | Digital power supply(+3.3V) |
| 5 | R0 | Red data(LSB) |
| 6 | R1 | Red data |
| 7 | R2 | Red data |
| 8 | R3 | Red data |
| 9 | R4 | Red data |
| 10 | R5 | Red data |
| 11 | R6 | Red data |
| 12 | R7 | Red data(MSB) |
| 13 | G0 | Green data(LSB) |
| 14 | G1 | Green data |
| 15 | G2 | Green data |
| 16 | G3 | Green data |
| 17 | G4 | Green data |
| 18 | G5 | Green data |
| 19 | G6 | Green data |
| 20 | G7 | Green data(MSB) |
| 21 | B0 | Blue data(LSB) |
| 22 | B1 | Blue data |
| 23 | B2 | Blue data |
| 24 | B3 | Blue data |
| 25 | B4 | Blue data |
| 26 | B5 | Blue data |
| 27 | B6 | Blue data |
| 28 | B7 | Blue data(MSB) |
| 29 | GND | Ground |
| 30 | DCLK | Data clk |

| | | |
|-----------|-------------|---|
| 31 | DISP | Display ON/OFF control. Internally pulled high |
| 32 | HS | Horizontal sync input in RGB mode |
| 33 | VS | Vertical sync input in RGB mode |
| 34 | DE | Data Enable |
| 35 | NC | No connection |
| 36 | GND | Ground |
| 37 | XR | T/p X-Right(No connection) |
| 38 | YD | T/p Y-Bottom(No connection) |
| 39 | XL | T/p X-Left(No connection) |
| 40 | YU | T/p Y-Up(No connection) |

3. Operation Specifications

3.1. Absolute Maximum Ratings

(Note 1)

| Item | Symbol | Values | | Unit | Remark |
|-----------------------|----------|--------|------|------|--------------------|
| | | Min. | Max. | | |
| Supply voltage | V_{DD} | -0.3 | 4.5 | V | |
| Operation Temperature | T_{OP} | -20 | 60 | °C | |
| Storage Temperature | T_{ST} | -30 | 70 | °C | |
| LED Reverse Voltage | VR | - | 5 | V | Each LED Note 2 |
| LED Forward Current | IF | - | 25 | mA | Each LED |

Note 1: The absolute maximum rating values of this product are not allowed to be exceeded at any times. Should a module be used with any of the absolute maximum ratings exceeded, the characteristics of the module may not be recovered, or in an extreme case, the module may be permanently destroyed.

Note 2: VR Conditions: Zener Diode 20mA

3.1.1. Typical Operation Conditions

| Item | Symbol | Values | | | Unit | Remark |
|--------------------------|--------------|--------------|-----|--------------|------|--------|
| | | Min. | Typ | Max. | | |
| Power voltage | V_{DD} | 3.0 | 3.3 | 3.6 | V | Note 2 |
| Current for Driver | $I_{V_{DD}}$ | - | 17 | 25 | mA | |
| Input logic high voltage | V_{IH} | $0.8 V_{DD}$ | - | V_{DD} | V | Note 3 |
| Input logic low voltage | V_{IL} | 0 | - | $0.2 V_{DD}$ | V | |

3.1.2. Backlight Driving Conditions

| Item | Symbol | Values | | | Unit | Remark |
|---------------------------|--------|--------|--------|------|------|--------|
| | | Min. | Typ. | Max. | | |
| Voltage for LED backlight | V_L | -- | 19.8 | -- | V | Note 1 |
| Current for LED backlight | I_L | -- | 40 | -- | mA | |
| LED life time | - | - | 20,000 | - | Hr | Note 2 |

Note 1: The LED Supply Voltage is defined by the number of LED at $T_a=25^{\circ}\text{C}$ and $I_L=40\text{mA}$.

Note 2: The "LED life time" is defined as the module brightness decrease to 50% original brightness at $T_a=25^{\circ}\text{C}$ and $I_L=40\text{mA}$. The LED lifetime could be decreased if operating I_L is larger than 40mA.

LED CIRCUIT

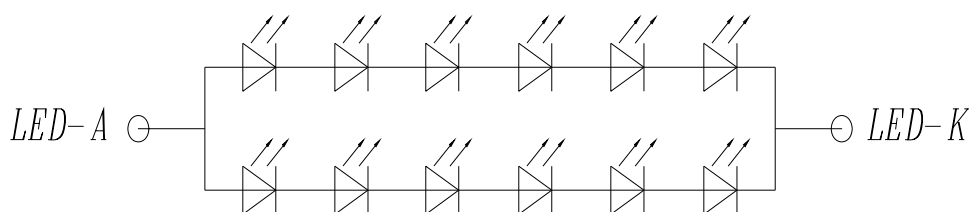

3.2. Power Sequence

Power on sequence

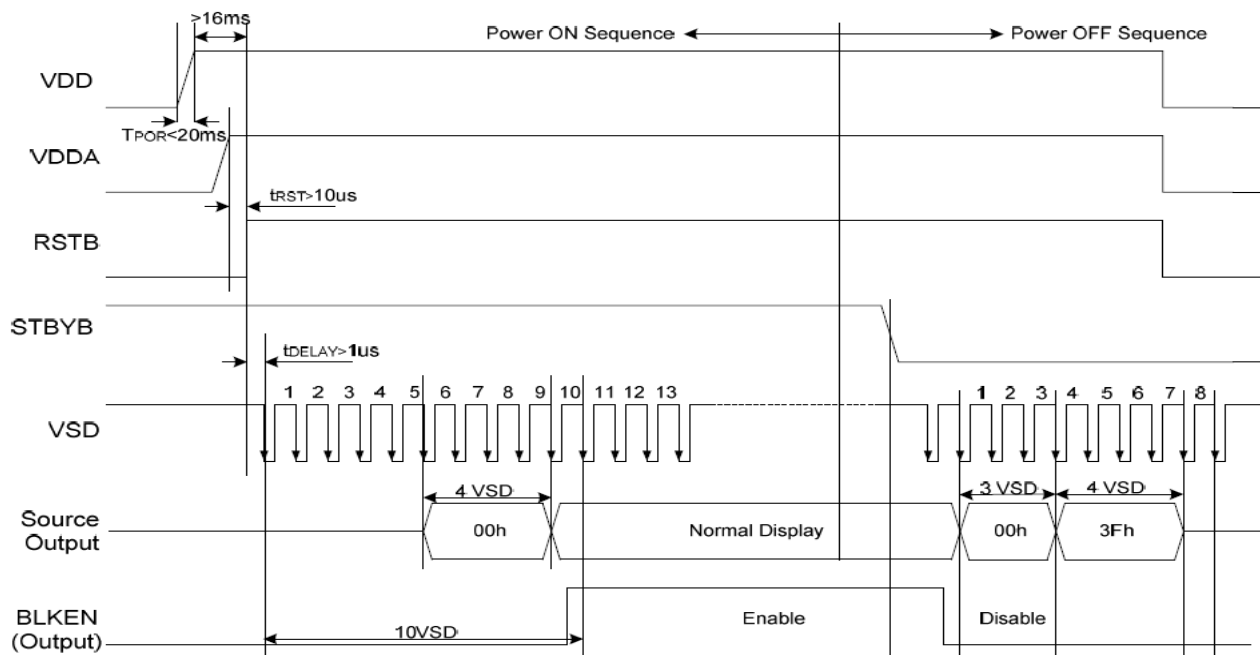

Note: For prevent anormal operation, t_{RST} must be longer than 10us during Power ON sequence.

Power off sequence

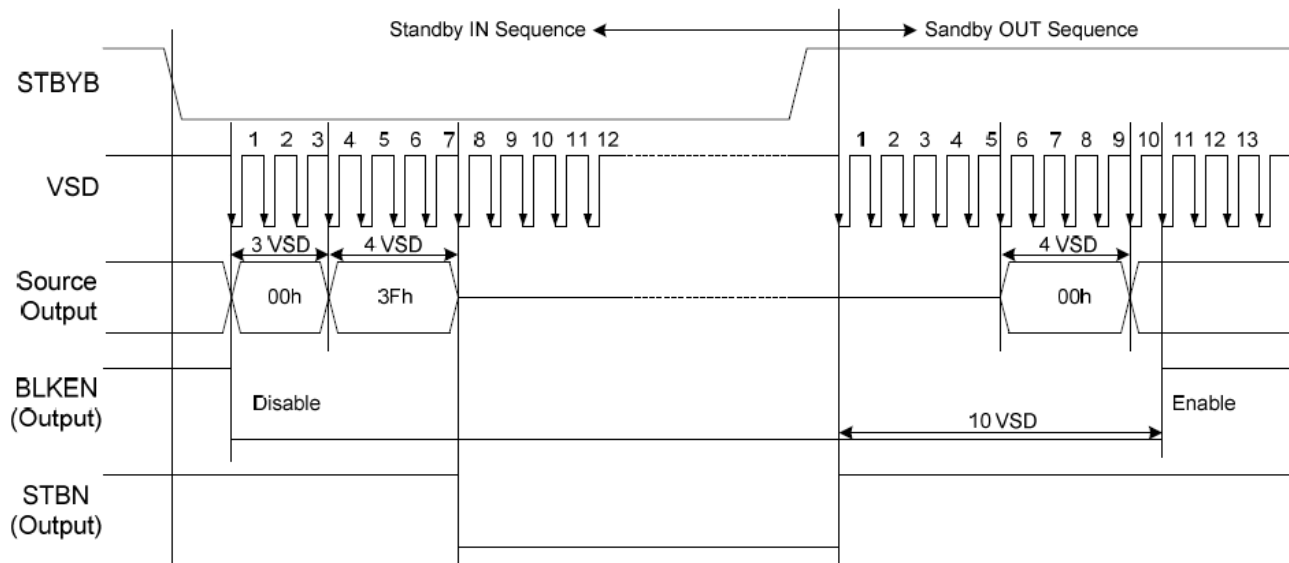

3.3. Timing Characteristics

3.3.1. Sync Mode

Horizontal Input Timing

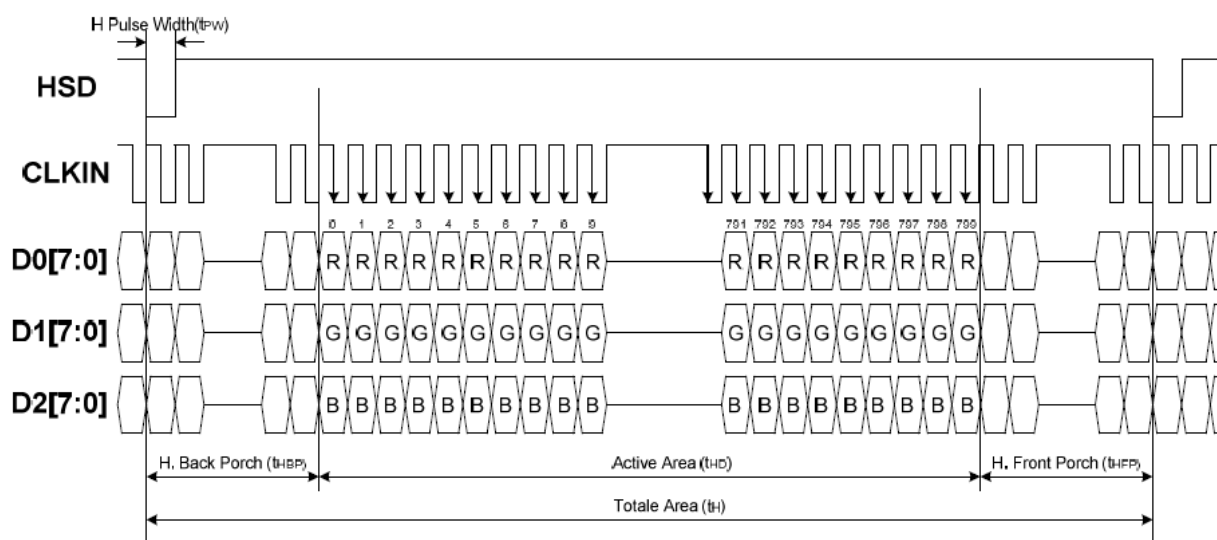

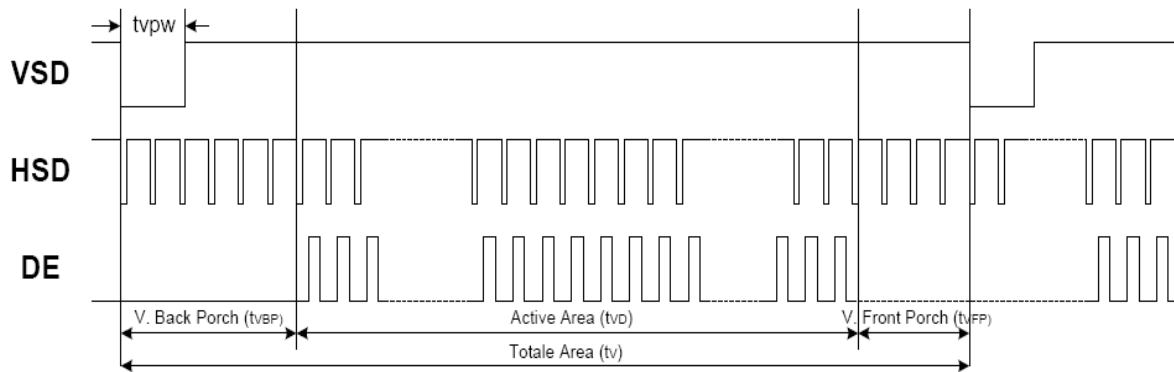

Timing Table

| Parameter | Symbol | Spec | | | Unit | Conditions |
|--------------------------------|-------------|------|------|------|-------|--|
| | | Min. | Typ. | Max. | | |
| VDD Power ON slew rate | t_{POR} | -- | -- | 20 | ms | 0V ~ 0.9VDD |
| RSTB pulse width | t_{RST} | 10 | -- | -- | us | CLKIN=50MHz |
| CLKIN cycle time | t_{CPH} | 20 | -- | -- | ns | |
| CLKIN pulse duty | t_{CWH} | 40 | 50 | 60 | % | |
| VSD setup time | t_{VST} | 8 | -- | -- | ns | |
| VSD hold time | t_{VHD} | 8 | -- | -- | ns | |
| HSD setup time | t_{HST} | 8 | -- | -- | ns | |
| HSD hold time | t_{HHD} | 8 | -- | -- | ns | |
| Data setup time | t_{DST} | 8 | -- | -- | ns | D0[7:0], D1[7:0], D2[7:0] to CLKIN |
| Data hold time | t_{DHD} | 8 | -- | -- | ns | D0[7:0], D1[7:0], D2[7:0] to CLKIN |
| DE setup time | t_{EST} | 8 | -- | -- | ns | |
| DE hold time | t_{EHD} | 8 | -- | -- | ns | |
| Output stable time | t_{SST} | -- | -- | 6 | us | 10% to 90% target voltage. CL=120pF, R=10KΩ |
| CLKIN frequency | f_{CLK} | -- | 40 | 50 | MHz | VDD=3.0 ~ 3.6V |
| CLKIN cycle time | t_{CLK} | 20 | 25 | -- | ns | |
| CLKIN pulse duty | t_{CWH} | 40 | 50 | 60 | % | T_{CLK} |
| Time from HSD to Source output | t_{HSO} | -- | 20 | -- | CLKIN | |
| Time from HSD to LD | t_{HLD} | -- | 20 | -- | CLKIN | Note (2) |
| Time from HSD to STV | t_{HSTV} | -- | 2 | -- | CLKIN | |
| Time from HSD to CKV | t_{HCKV} | -- | 20 | -- | CLKIN | |
| Time from HSD to OEV | t_{HOEV} | -- | 4 | -- | CLKIN | |
| LD pulse width | t_{WLD} | -- | 10 | -- | CLKIN | Note (2) |
| CKV pulse width | t_{WCKV} | -- | 66 | -- | CLKIN | |
| OEV pulse width | t_{WEOEV} | -- | 74 | -- | CLKIN | |

Note: (1) VDD=3.0 ~ 3.6V, VDDA=6.5~13.5V, DGND=AGND=0V, Ta=-20~+85°C

(2) The contents of the data register are transferred to the latch circuit at the rising edge of LD. Then the gray scale voltage is output from the device at the falling edge of LD.

(3) Output loading condition :

3.3.2. De Mode

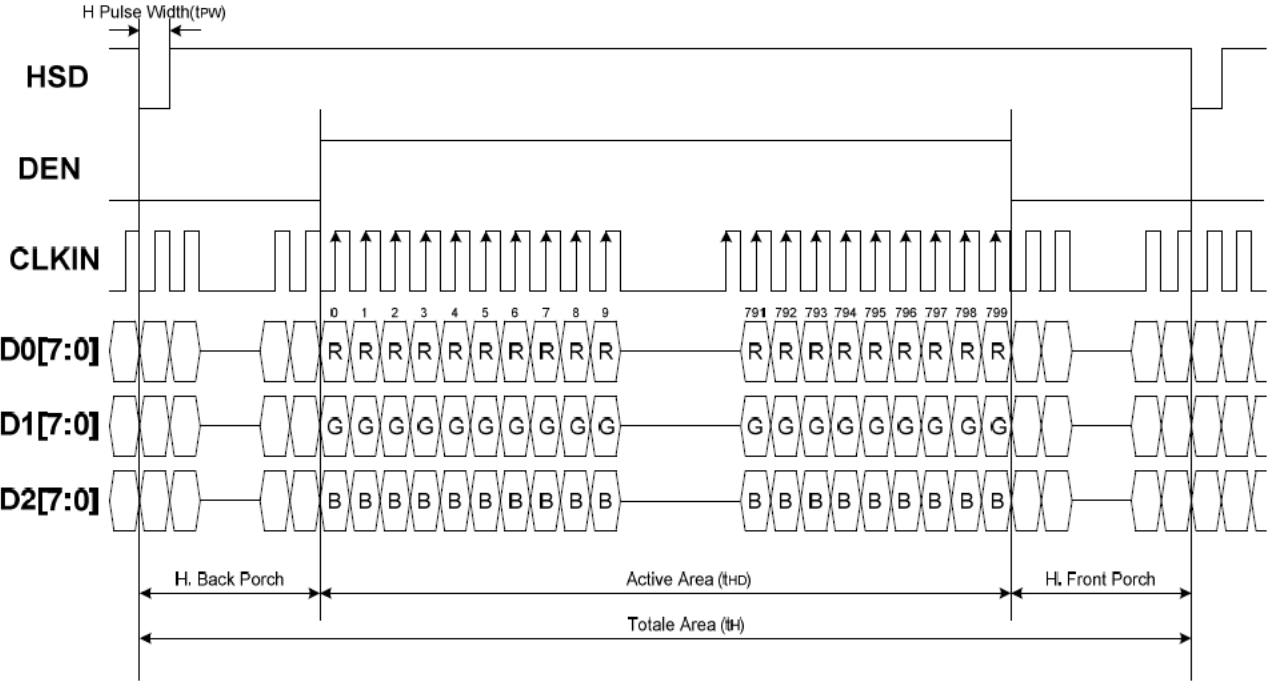

4. Optical Specifications

| Item | Symbol | Condition | Values | | | Unit | Remark |
|---------------------------|------------|---------------------------------|--------|------|------|-------------------|------------------|
| | | | Min. | Typ. | Max. | | |
| Viewing angle (CR≥ 10) | θ_L | $\Phi=180^\circ$ (9 o'clock) | - | 70 | - | degree | Note 1 |
| | θ_R | $\Phi=0^\circ$ (3 o'clock) | - | 70 | - | | |
| | θ_T | $\Phi=90^\circ$ (12 o'clock) | - | 50 | - | | |
| | θ_B | $\Phi=270^\circ$ (6 o'clock) | - | 70 | - | | |
| Response time | T_{ON} | Normal $\theta=\Phi=0^\circ$ | - | 10 | 20 | msec | Note 3 |
| | T_{OFF} | | - | 10 | 20 | msec | Note 3 |
| Contrast ratio | CR | | 500 | 700 | - | - | Note 4 |
| Color chromaticity | W_X | | 0.26 | 0.31 | 0.36 | - | Note 2 Note 5 |
| | W_Y | | 0.28 | 0.33 | 0.38 | - | Note 6 |
| Luminance | L | | 200 | 250 | - | cd/m ² | Note 6 |
| Luminance uniformity | Y_U | | 70 | 75 | - | % | Note 7 |

Test Conditions:

1. $V_{DD}=3.3V$, $I_L=40mA$ (Backlight current), the ambient temperature is $25^\circ C$.
2. The test systems refer to Note 2.

Note 1: Definition of viewing angle range

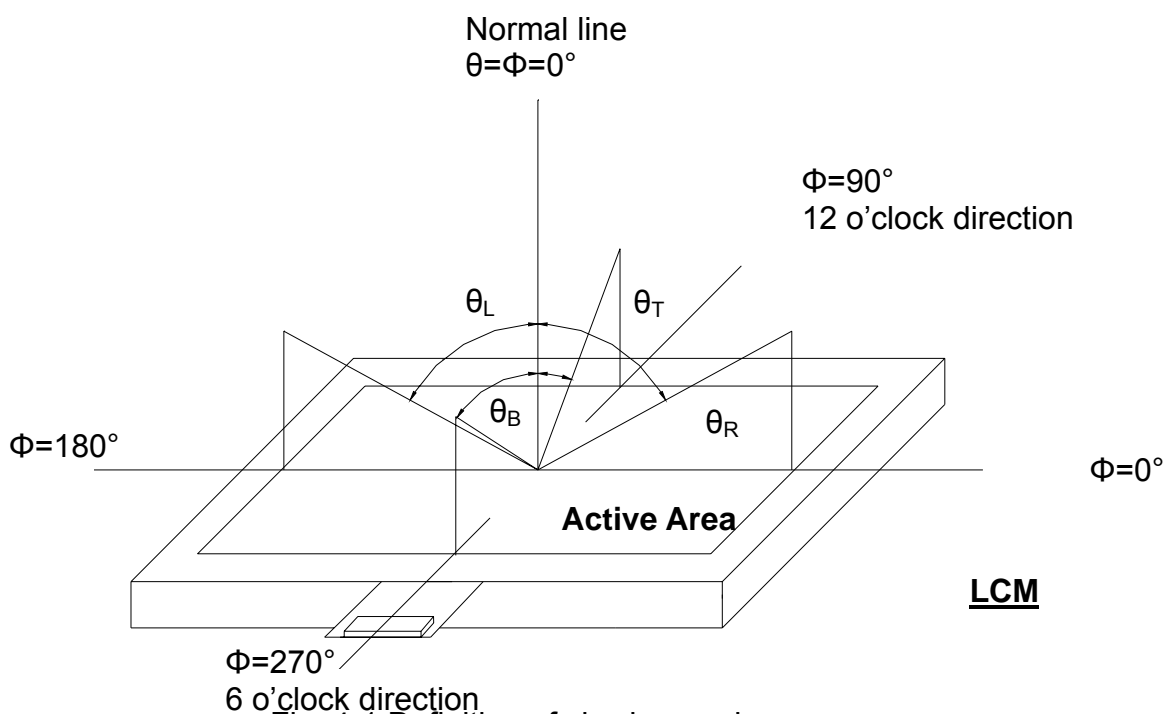

Fig. 4-1 Definition of viewing angle

Note 2: Definition of optical measurement system.

The optical characteristics should be measured in dark room. After 30 minutes operation, the optical properties are measured at the center point of the LCD screen. (Response time is measured by Photo detector TOPCON BM-7, other items are measured by BM-5A/Field of view: 1° /Height: 500mm.)

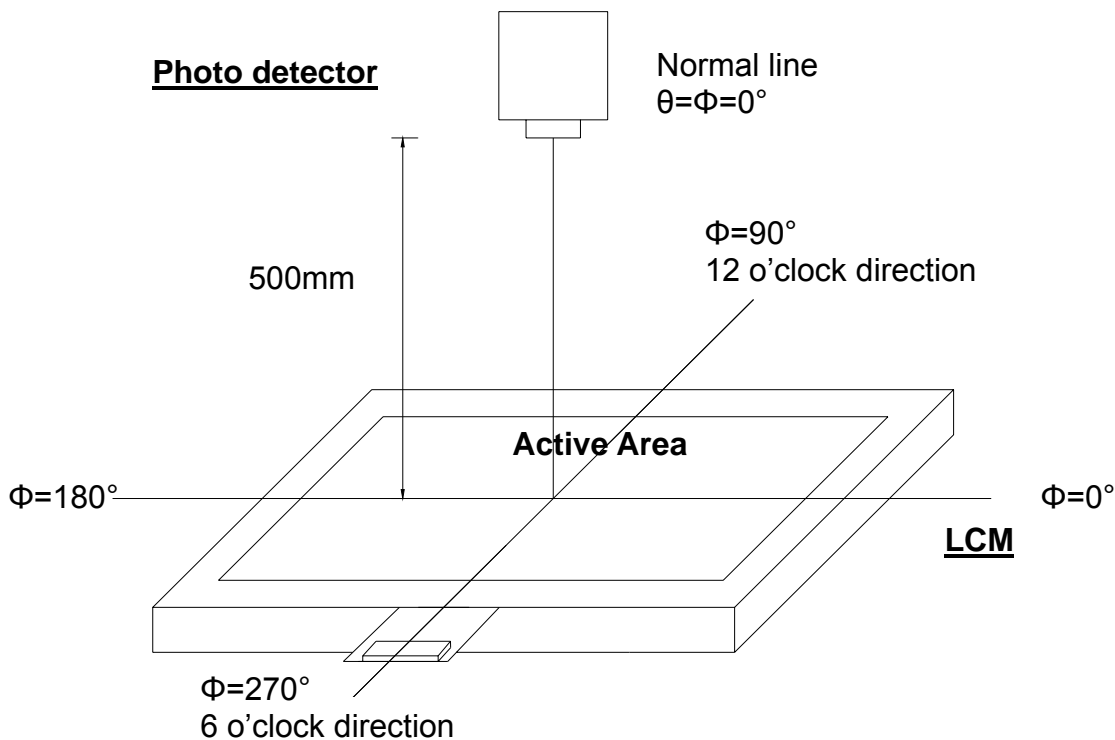

Fig. 4-2 Optical measurement system setup

Note 3: Definition of Response time

The response time is defined as the LCD optical switching time interval between "White" state and "Black" state. Rise time (T_{ON}) is the time between photo detector output intensity changed from 90% to 10%. And fall time (T_{OFF}) is the time between photo detector output intensity changed from 10% to 90%.

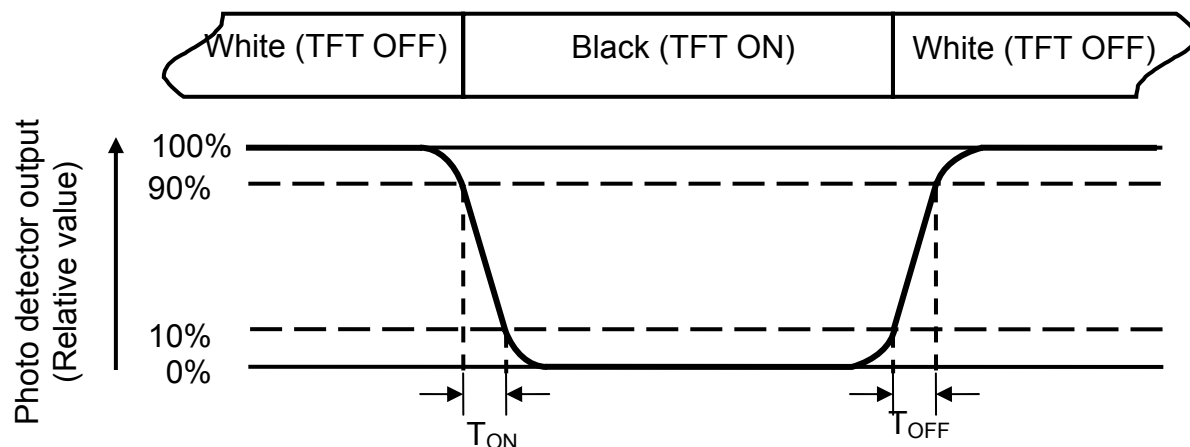

Fig. 4-3 Definition of response time

Note 4: Definition of contrast ratio

$$\text{Contrast ratio (CR)} = \frac{\text{Luminance measured when LCD on the "White" state}}{\text{Luminance measured when LCD on the "Black" state}}$$

Note 5: Definition of color chromaticity (CIE1931)

Color coordinates measured at center point of LCD.

Note 6: All input terminals LCD panel must be ground while measuring the center area of the panel. The LED driving condition is $I_L=40\text{mA}$.

Note 7: Definition of Luminance Uniformity

Active area is divided into 9 measuring areas (Refer to Fig. 4-4).Every measuring point is placed at the center of each measuring area.

$$\text{Luminance Uniformity (Yu)} = \frac{B_{min}}{B_{max}}$$

L-----Active area length W----- Active area width

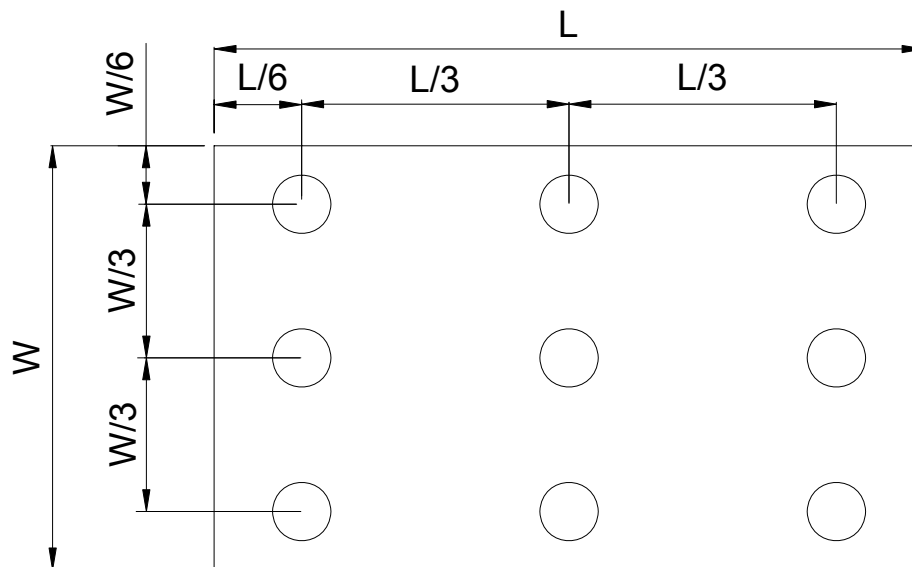

Fig. 4-4 Definition of measuring points

B_{max}: The measured maximum luminance of all measurement position.

B_{min}: The measured minimum luminance of all measurement position.

5. Reliability Test Items

(Note3)

| Item | Test Conditions | Remark |
|--|--|----------------|
| High Temperature Storage | Ta = 70°C 240hrs | Note 1, Note 4 |
| Low Temperature Storage | Ta = -30°C 240hrs | Note 1, Note 4 |
| High Temperature Operation | Ts = 60°C 240hrs | Note 2, Note 4 |
| Low Temperature Operation | Ta = -20°C 240hrs | Note 1, Note 4 |
| Operate at High Temperature and Humidity | +40°C, 90%RH 240hrs | Note 4 |
| Thermal Shock | -30°C/30 min ~ +70°C/30 min for a total 100 cycles, Start with cold temperature and end with high temperature. | Note 4 |
| Vibration Test | Frequency range:10~55Hz Stroke:1.5mm Sweep:10Hz~55Hz~10Hz 2 hours for each direction of X. Y. Z. (6 hours for total) | |
| Mechanical Shock | 100G 6ms,±X, ±Y, ±Z 3 times for each direction | |
| Package Vibration Test | Random Vibration : 0.015G*G/Hz from 5-200HZ, -6dB/Octave from 200-500HZ 2 hours for each direction of X. Y. Z. (6 hours for total) | |
| Package Drop Test | Height:60 cm 1 corner, 3 edges, 6 surfaces | |
| Electro Static Discharge | ± 2KV, Human Body Mode, 100pF/1500Ω | |

Note 1: Ta is the ambient temperature of samples.

Note 2: Ts is the temperature of panel's surface.

Note 3: In the standard condition, there shall be no practical problem that may affect the display function. After the reliability test, the product only guarantees operation, but don't guarantee all of the cosmetic specification.

Note 4: Before cosmetic and function test, the product must have enough recovery time, at least 2 hours at room temperature.

6. General Precautions

6.1. Safety

Liquid crystal is poisonous. Do not put it in your mouth. If liquid crystal touches your skin or clothes, wash it off immediately by using soap and water.

6.2. Handling

1. The LCD panel is plate glass. Do not subject the panel to mechanical shock or to excessive force on its surface.
2. The polarizer attached to the display is easily damaged. Please handle it carefully to avoid scratch or other damages.
3. To avoid contamination on the display surface, do not touch the module surface with bare hands.
4. Keep a space so that the LCD panels do not touch other components.
5. Put cover board such as acrylic board on the surface of LCD panel to protect panel from damages.
6. Transparent electrodes may be disconnected if you use the LCD panel under environmental conditions where the condensation of dew occurs.
7. Do not leave module in direct sunlight to avoid malfunction of the ICs.

6.3. Static Electricity

1. Be sure to ground module before turning on power or operating module.
2. Do not apply voltage which exceeds the absolute maximum rating value.

6.4. Storage

1. Store the module in a dark room where must keep at $25\pm 10^{\circ}\text{C}$ and 65%RH or less.
2. Do not store the module in surroundings containing organic solvent or corrosive gas.
3. Store the module in an anti-electrostatic container or bag.

6.5. Cleaning

1. Do not wipe the polarizer with dry cloth. It might cause scratch.
2. Only use a soft sloth with IPA to wipe the polarizer, other chemicals might permanent damage to the polarizer.

7. Mechanical Drawing

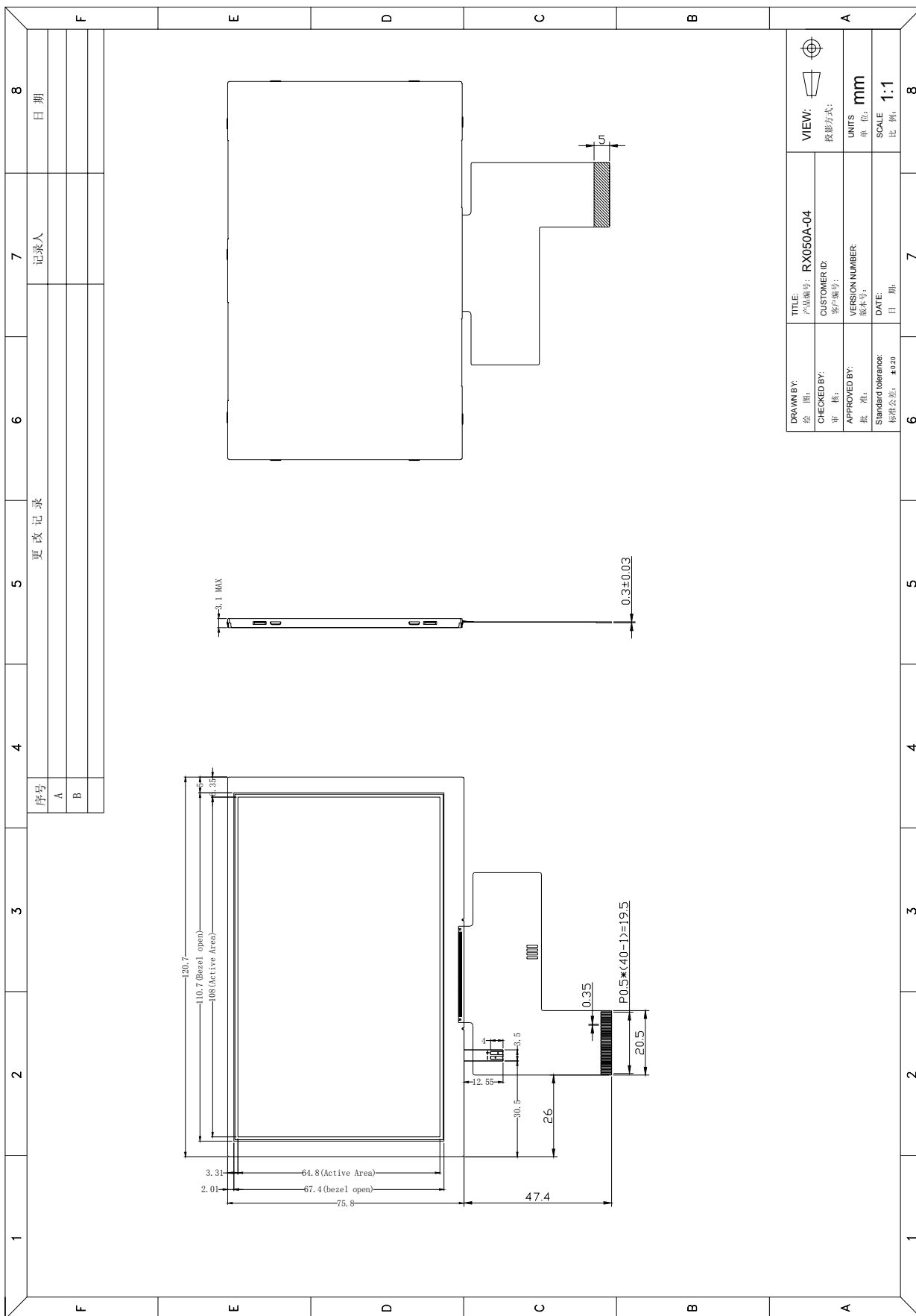



Компания «ЭлектроПласт» предлагает заключение долгосрочных отношений при поставках импортных электронных компонентов на взаимовыгодных условиях!

Наши преимущества:

- Оперативные поставки широкого спектра электронных компонентов отечественного и импортного производства напрямую от производителей и с крупнейших мировых складов;
- Поставка более 17-ти миллионов наименований электронных компонентов;
- Поставка сложных, дефицитных, либо снятых с производства позиций;
- Оперативные сроки поставки под заказ (от 5 рабочих дней);
- Экспресс доставка в любую точку России;
- Техническая поддержка проекта, помощь в подборе аналогов, поставка прототипов;
- Система менеджмента качества сертифицирована по Международному стандарту ISO 9001;
- Лицензия ФСБ на осуществление работ с использованием сведений, составляющих государственную тайну;
- Поставка специализированных компонентов (Xilinx, Altera, Analog Devices, Intersil, Interpoint, Microsemi, Aeroflex, Peregrine, Syfer, Eurofarad, Texas Instrument, Miteq, Cobham, E2V, MA-COM, Hittite, Mini-Circuits, General Dynamics и др.);

Помимо этого, одним из направлений компании «ЭлектроПласт» является направление «Источники питания». Мы предлагаем Вам помощь Конструкторского отдела:

- Подбор оптимального решения, техническое обоснование при выборе компонента;
- Подбор аналогов;
- Консультации по применению компонента;
- Поставка образцов и прототипов;
- Техническая поддержка проекта;
- Защита от снятия компонента с производства.



Как с нами связаться

Телефон: 8 (812) 309 58 32 (многоканальный)

Факс: 8 (812) 320-02-42

Электронная почта: org@eplast1.ru

Адрес: 198099, г. Санкт-Петербург, ул. Калинина, дом 2, корпус 4, литера А.