

General Specifications

B Electrical Capacity (Resistive Load)

Power Level (silver): 6A @ 125V AC & 3A @ 250V AC
4A @ 30V DC for On-None-On; 3A @ 30V DC for all other circuits

Logic Level (gold): 0.4VA maximum @ 28V AC/DC maximum
(Applicable Range 0.1mA ~ 0.1A @ 20mV ~ 28V)

Logic/Power Level (gold over silver): Combines silver & gold ratings
Note: Find additional explanation of dual rating & operating range in Supplement section.

Other Ratings

Contact Resistance: 10 milliohms maximum for silver; 20 milliohms maximum for gold

Insulation Resistance: 1,000 megohms minimum @ 500V DC

Dielectric Strength: 1,000V AC minimum between contacts for 1 minute minimum;
1,500V AC minimum between contacts and case for 1 minute minimum

Mechanical Life: 50,000 operations minimum

Electrical Life: 25,000 operations minimum for silver; 50,000 operations minimum for gold;
50,000 operations minimum for silver at 3A @ 125V AC

Angle of Throw: 25°

Materials & Finishes

Actuator Clip & Mounting Frame: Stainless Steel

Body Frame: Stainless steel

Case: Diallyl phthalate resin (UL94V-0)

Movable Contactor: Phosphor bronze with silver or gold plating

Movable Contacts: Silver alloy (code W); copper with gold plating (code G); or silver alloy with gold plating (code A)

Stationary Contacts: Silver with silver plating (code W); copper or brass with gold plating (code G);
or silver with gold plating (code A)

Terminals: Copper or brass with silver plating; or copper or brass with gold plating

Environmental Data

Operating Temp Range: -30°C through +85°C (-22°F through +185°F)

Humidity: 90 ~ 95% humidity for 96 hours @ 40°C (104°F)

Vibration: 10 ~ 55Hz with peak-to-peak amplitude of 1.5mm traversing the frequency range & returning
in 1 minute; 3 right angled directions for 2 hours

Shock: 50G (490m/s²) acceleration (tested in 6 right angled directions, with 5 shocks in each direction)

Processing

Soldering: Wave Soldering (PC version) for Gold: See Profile A in Supplement section.

Manual Soldering for Gold: See Profile A in Supplement section.

Wave Soldering (PC version) for Silver: See Profile B in Supplement section.

Manual Soldering for Silver: See Profile B in Supplement section.

Note: Actuator must be in OFF (center) position while soldering.

Cleaning: These devices are not process sealed. Hand clean locally using alcohol based solution.

Standards & Certifications

Flammability Standards: UL94V-0 for case

UL: File No. E44145 - Recognized only when ordered with marking on switch.

Add "/U" before first dash in part number to order UL recognized switch.

All models recognized at 6A @ 125V AC, 3A @ 250V AC or 0.4VA maximum @ 28V DC maximum.

CSA: File No. 023535_0_000 - Certified only when ordered with marking on switch.

Add "/C" before first dash in part number to order CSA certified switch.

All models certified at 6A @ 125V AC or 3A @ 250V AC or 0.4VA maximum @ 28V maximum.

Distinctive Characteristics

Three methods of panel mounting: flat frame for flush with face or subpanel, snap-in, and PCB.

High insulating barriers increase isolation of circuits in multipole devices and provide added protection to contact points.

The molded diallyl phthalate case has a UL 94V-0 flammability rating.

Epoxy sealed terminals prevent entry of solder flux and other contaminants.

Prominent external insulating barriers increase insulation resistance and dielectric strength.

Bias guard prevents misalignment of contacts; interlocking of actuator block with rocker and internal guide does not allow transmission of diagonal force on rocker to reach contact mechanism.

Clinching of the frame to the case well above the base and terminals provides 1,500V dielectric strength.



Actual Size



- Toggle
- B** Rockers
- Pushbuttons
- Illuminated PB
- Programmable
- Keylocks
- Rotaries
- Slides
- Tactiles
- Tilt
- Touch
- Indicators
- Accessories
- Supplement

TYPICAL SWITCH ORDERING EXAMPLE



IMPORTANT:



Switches are supplied without UL & CSA marking unless specified.

UL & CSA recognized only when ordered with marking on the switch.

Specific models, ratings, & ordering instructions are noted on General Specifications page.

* Wire harness & cable assemblies offered only in Americas

DESCRIPTION FOR TYPICAL ORDERING EXAMPLE

M2012TNW01-DC



POLES & CIRCUITS

Pole	Model	Rocker Position () = Momentary			Connected Terminals			Throw & Schematics
		Down	Center	Up	Down	Center	Up	
SP	M2012 M2013 M2015 M2018 M2019	ON ON ON (ON) ON	NONE OFF NONE OFF OFF	ON ON (ON) (ON) (ON)	2-3	OPEN	2-1	Note: Terminal numbers are not actually on the switch.
DP	M2022 M2023 M2025 M2028 M2029	ON ON ON (ON) ON	NONE OFF NONE OFF OFF	ON ON (ON) (ON) (ON)	2-3 5-6	OPEN	2-1 5-4	
3P	M2032 M2033 M2035 M2038 M2039	ON ON ON (ON) ON	NONE OFF NONE OFF OFF	ON ON (ON) (ON) (ON)	2-3 5-6 8-9	OPEN	2-1 5-4 8-7	
4P	M2042 M2043 M2045 M2048 M2049	ON ON ON (ON) ON	NONE OFF NONE OFF OFF	ON ON (ON) (ON) (ON)	2-3 5-6 8-9 11-12	OPEN	2-1 5-4 8-7 11-10	

For 3 Throw (3-On)

Connected Terminals & Schematics

Pole	Model	Down	Center	Up	Down	Center	Up
SP	M2024 M2026 M2027	ON (ON) ON	ON ON ON	ON (ON) (ON)	 2-3 5-6	 2-3 5-4	 2-1 5-4
DP	M2044 M2046 M2047	ON (ON) ON	ON ON ON	ON (ON) (ON)	 2-3 5-6 8-9 11-12	 2-3 5-4 8-9 11-10	 2-1 5-4 8-7 11-10

The SP3T model utilizes a double pole base.

External connection must be made during field installation.



The DP3T model utilizes a four pole base.

External connection must be made during field installation.

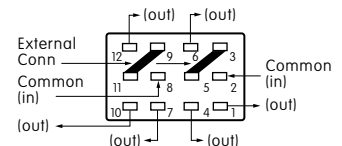

MOUNTING FRAMES

TN .272" (6.9mm)
Wide Flat Frame

Mounting hardware kit HK-1, as shown on the following page, must be ordered separately.



Small Actuators & Panel Cutouts for TN Frame (actuator details on the following pages)

AT4148

AT4149

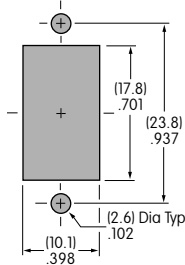

AT4150

AT4151

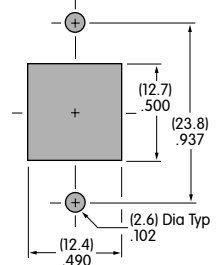

TY .504" (12.8mm)
Wide Flat Frame

Large Actuators & Panel Cutout for TY Frame
(actuator details on the following pages)

Mounting hardware kit HK-2, as shown on the following page, must be ordered separately.

AT4156

AT4157

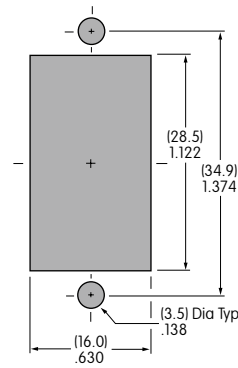
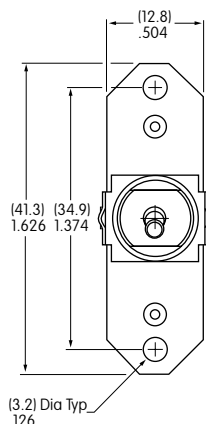
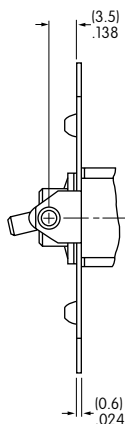

- Toggles
- B** Rockers
- Pushbuttons
- Illuminated PB
- Programmable
- Keylocks
- Rotaries
- Slides
- Tactiles
- Tilt
- Touch
- Indicators
- Accessories
- Supplement

MOUNTING FRAMES (CONTINUED)

Face Panel Mounting



Flat frame devices may also be mounted to the face panel. Standoffs are used to recess the actuator and achieve an attractive front panel appearance.

Subpanel Mounting



These devices are especially designed for subpanel mounting. When installed on a mounting plate behind the panel, hardware is completely concealed and the front panel retains a clean, attractive appearance.

Optional Snap-in Panel Frames



AT064-1
AT064-2



AT065-1
AT065-2

Further details are shown in the previous bracketed PC mount subsection.

Optional Hardware Kits for Subpanel or Face Panel Mounting			
Frame	Panel Thickness	Standoff Length	Hardware Kit Number
TN Frame	.125" (3.175mm)	.233" (5.918mm)	ATHK-1
TY Frame	.125" (3.175mm)	.312" (7.925mm)	ATHK-2
Hardware kits include: 2 stainless steel screws, 2 hex nuts, 2 lockwashers, & 2 standoffs			

CONTACT MATERIALS & RATINGS

W

Silver over Silver

Power Level

6A @ 125V AC & 3A @ 250V AC

G

Gold over Brass or Copper

Logic Level

0.4VA maximum @ 28V AC/DC maximum

Note: See Supplement section to find complete explanation of operating range.

A

Gold over Silver

**Power Level
or Logic Level**

**6A @ 125V AC
or 0.4VA maximum @ 28V AC/DC maximum**

Note: This dual rated option is suitable when two or more identical switches are used in logic and in power circuits within the same application. See Supplement section to find complete explanation of dual rating and operating range.

TERMINALS

01

Solder Lug

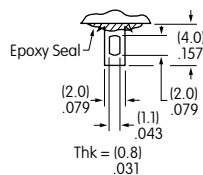

03

**.250" (6.35mm)
Straight PC**

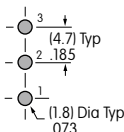
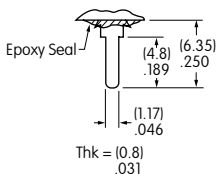

Single Pole

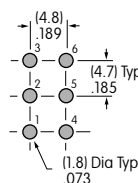

Double Pole

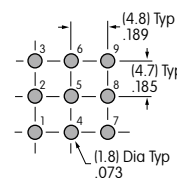

Three Pole

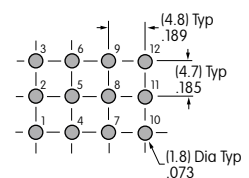

Four Pole

ROCKERS & PADDLES

For TN Frame

D AT4148 .365" (9.27mm)
Wide Rocker

Material: Polyamide
Finish: Matte



E AT4149 .365" (9.27mm)
Wide Paddle

Material: Polyamide
Finish: Matte



F AT4150 .450" (11.43mm)
Wide Rocker

Material: Polyamide
Finish: Matte



G AT4151 .450" (11.43mm)
Wide Paddle

Material: Polyamide
Finish: Matte



For TY Frame

J AT4156 .595" (15.11mm)
Wide Rocker

Material: Polyamide
Finish: Matte



H AT4157 .595" (15.11mm)
Wide Paddle

Material: Polyamide
Finish: Matte

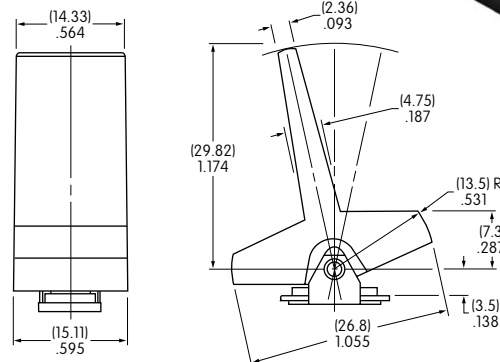

Cap Colors Available:

- A** Black
- B** White
- C** Red
- E** Yellow
- F** Green
- G** Blue
- H** Gray

TYPICAL SWITCH DIMENSIONS

TN Frame • Solder Lug



M2012TNW01-DC

Single Pole



TN Frame • Solder Lug



M2022TNW01-DC

Double Pole



TN Frame • Solder Lug



M2032TNW01-DC

Three Pole



TN Frame • Solder Lug



M2042TNW01-DC

Four Pole

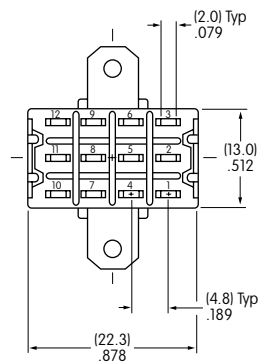
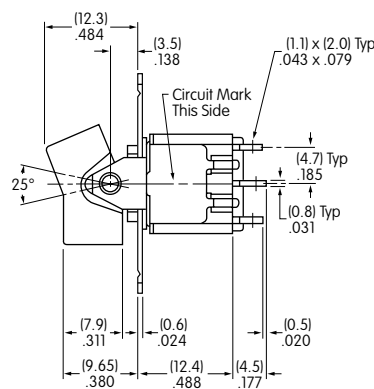
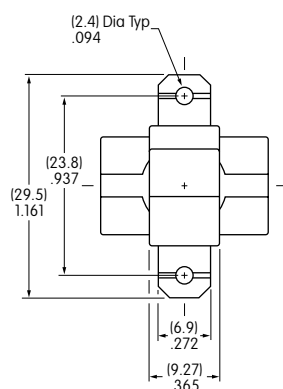

TYPICAL SWITCH DIMENSIONS



TY Frame • Solder Lug



M2012TYW01-JC

Three Pole



TY Frame • Solder Lug



M2032TYW01-JC

Four Pole



TY Frame • Solder Lug



M2042TYW01-JC

LEGENDS

NKK Switches can provide custom legends for caps. Contact factory for more information.

Suggested Printable Area for Caps

AT4148



AT4150



AT4156

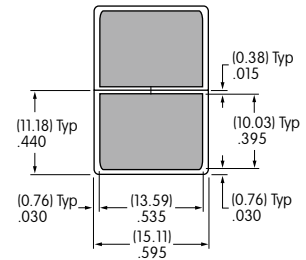

Shaded areas are printable areas.

Recommended Print Method:

Pad Print

Epoxy based ink is recommended.



Компания «ЭлектроПласт» предлагает заключение долгосрочных отношений при поставках импортных электронных компонентов на взаимовыгодных условиях!

Наши преимущества:

- Оперативные поставки широкого спектра электронных компонентов отечественного и импортного производства напрямую от производителей и с крупнейших мировых складов;
- Поставка более 17-ти миллионов наименований электронных компонентов;
- Поставка сложных, дефицитных, либо снятых с производства позиций;
- Оперативные сроки поставки под заказ (от 5 рабочих дней);
- Экспресс доставка в любую точку России;
- Техническая поддержка проекта, помощь в подборе аналогов, поставка прототипов;
- Система менеджмента качества сертифицирована по Международному стандарту ISO 9001;
- Лицензия ФСБ на осуществление работ с использованием сведений, составляющих государственную тайну;
- Поставка специализированных компонентов (Xilinx, Altera, Analog Devices, Intersil, Interpoint, Microsemi, Aeroflex, Peregrine, Syfer, Eurofarad, Texas Instrument, Miteq, Cobham, E2V, MA-COM, Hittite, Mini-Circuits, General Dynamics и др.);

Помимо этого, одним из направлений компании «ЭлектроПласт» является направление «Источники питания». Мы предлагаем Вам помощь Конструкторского отдела:

- Подбор оптимального решения, техническое обоснование при выборе компонента;
- Подбор аналогов;
- Консультации по применению компонента;
- Поставка образцов и прототипов;
- Техническая поддержка проекта;
- Защита от снятия компонента с производства.



Как с нами связаться

Телефон: 8 (812) 309 58 32 (многоканальный)

Факс: 8 (812) 320-02-42

Электронная почта: org@eplast1.ru

Адрес: 198099, г. Санкт-Петербург, ул. Калинина, дом 2, корпус 4, литера А.