

ISL90841

Quad Digitally Controlled Potentiometers (XDCP™) Low Noise, Low Power I²C

FN8094
Rev 1.00
February 8, 2006

The ISL90841 integrates four digitally controlled potentiometers (XDCP) on a monolithic CMOS integrated circuit.

The digitally controlled potentiometers are implemented with a combination of resistor elements and CMOS switches. The position of the wipers are controlled by the user through the I²C bus interface. Each potentiometer has an associated Wiper Register (WR) that can be directly written to and read by the user. The contents of the WR controls the position of the wiper.

All four potentiometers have one terminal tied to GND. The DCPs can be used as a resistor divider or as two-terminal variable resistors in a wide variety of applications including control, parameter adjustments, and signal processing.

Features

- Four potentiometers in one package
- 256 resistor taps - 0.4% resolution
- I²C serial interface
- Wiper resistance: 70Ω typical @ 3.3V
- Standby current <5μA max
- Power supply: 2.7V to 5.5V
- 50kΩ, 10kΩ total resistance
- 14 Lead TSSOP
- Pb-free plus anneal available (RoHS compliant)

Pinout

ISL90841
(14 LEAD TSSOP)
TOP VIEW

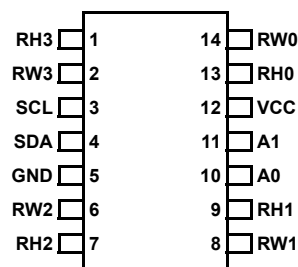

Ordering Information

PART NUMBER	PART MARKING	RESISTANCE OPTION (Ω)	TEMP RANGE (°C)	PACKAGE
ISL90841UIV1427Z (Notes 1 & 2)	90841UI27Z	50K	-40 to +85	14 Ld TSSOP (Pb-Free)
ISL90841WIV1427Z (Notes 1 & 2)	90841WI27Z	10K	-40 to +85	14 Ld TSSOP (Pb-Free)

NOTES:

1. Intersil Pb-free plus anneal products employ special Pb-free material sets; molding compounds/die attach materials and 100% matte tin plate termination finish, which are RoHS compliant and compatible with both SnPb and Pb-free soldering operations. Intersil Pb-free products are MSL classified at Pb-free peak reflow temperatures that meet or exceed the Pb-free requirements of IPC/JEDEC J STD-020.
2. Add "-TK" to suffix for Tape and Reel.

Functional Diagram

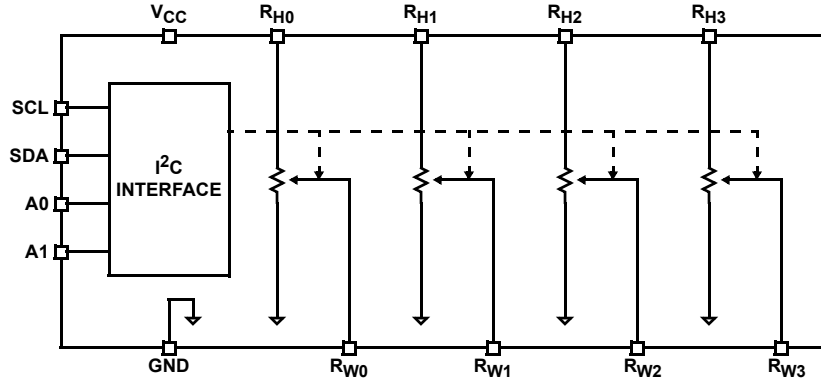

Block Diagram

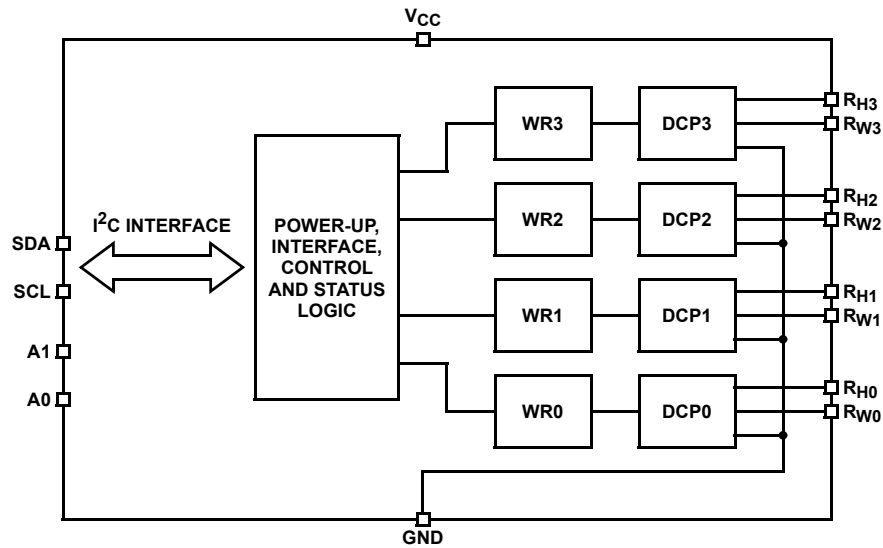

Pin Descriptions

TSSOP PIN	SYMBOL	DESCRIPTION
1	RH3	"High" terminal of DCP3
2	RW3	"Wiper" terminal of DCP3
3	SCL	I ² C interface clock
4	SDA	Serial data I/O for the I ² C interface
5	GND	Device ground pin
6	RW2	"Wiper" terminal of DCP2
7	RH2	"High" terminal of DCP2
8	RW1	"Wiper" terminal of DCP1
9	RH1	"High" terminal of DCP1
10	A0	Device address for the I ² C interface
11	A1	Device address for the I ² C interface
12	VCC	Power supply pin
13	RH0	"High" terminal of DCP0
14	RW0	"Wiper" terminal of DCP0

Absolute Maximum Ratings

Storage temperature	-65°C to +150°C
Voltage at any digital interface pin with respect to GND	-0.3V to $V_{CC}+0.3$
V_{CC}	-0.3V to +6V
Voltage at any DCP pin with respect to GND	-0.3V to V_{CC}
Lead temperature (soldering, 10s)	300°C
I_W (10s)	±6mA
Latchup	Class II, Level B at +85°C
ESD	>2kV Human Body Model

Recommended Operating Conditions

Industrial	-40°C to +85°C
V_{CC}	2.7V to 5.5V
Power rating of each DCP	5mW
Wiper current of each DCP	±3.0mA

CAUTION: Stresses above those listed in "Absolute Maximum Ratings" may cause permanent damage to the device. This is a stress only rating and operation of the device at these or any other conditions above those indicated in the operational sections of this specification is not implied.

Analog Specifications Over recommended operating conditions unless otherwise stated.

SYMBOL	PARAMETER	TEST CONDITIONS	MIN	TYP (NOTE 1)	MAX	UNIT
R _{TOTAL}	R _H to GND resistance	W option		10		kΩ
		U option		50		kΩ
	R _H to GND resistance tolerance		-20		+20	%
R _W	Wiper resistance	$V_{CC} = 3.3V @ 25^{\circ}C$, wiper current = V_{CC}/R_{TOTAL}		70	200	Ω
C _H /C _L /C _W	Potentiometer capacitance (Note 15)			10/10/25		pF
I _{LkgDCP}	Leakage on DCP pins (Note 15)	Voltage at pin from GND to V_{CC}		0.1	1	μA
VOLTAGE DIVIDER MODE (V_{CC} @ R _H i; measured at R _{Wi} , unloaded; i = 0, 1, 2, or 3)						
INL (Note 6)	Integral non-linearity		-1		1	LSB (Note 2)
DNL (Note 5)	Differential non-linearity	Monotonic over all tap positions	-0.5		0.5	LSB (Note 2)
ZSerror (Note 3)	Zero-scale error	W option	0	1	7	LSB (Note 2)
		U option	0	0.5	2	
FSerror (Note 4)	Full-scale error	W option	-7	-1	0	LSB (Note 2)
		U option	-2	-1	0	
V _{MATCH} (Note 7)	DCP to DCP matching	Any two DCPs at same tap position, same voltage at all R _H terminals	-2		2	LSB (Note 2)
TC _V (Note 8)	Ratiometric temperature coefficient	DCP register set to 80 hex		±4		ppm/°C
RESISTOR MODE (Measurements between R _{Wi} and R _H i. i = 0, 1, 2 or 3)						
RINL (Note 12)	Integral non-linearity	DCP register set between 20 hex and FF hex; monotonic over all tap positions	-1		1	MI (Note 9)
RDNL (Note 11)	Differential non-linearity		-0.5		0.5	MI (Note 9)
Roffset (Note 10)	Offset	W option	0	1	7	MI (Note 9)
		U option	0	0.5	2	MI (Note 9)
R _{MATCH} (Note 13)	DCP to DCP matching	Any two DCPs at the same tap position with the same terminal voltages	-2		2	MI (Note 9)
TC _R (Note 14)	Resistance temperature coefficient	DCP register set between 20 hex and FF hex		±45		ppm/°C

Operating Specifications Over the recommended operating conditions unless otherwise specified.

SYMBOL	PARAMETER	TEST CONDITIONS	MIN	TYP (NOTE 1)	MAX	UNIT
I_{CC1}	V_{CC} supply current (volatile write/read)	$f_{SCL} = 400\text{kHz}$; SDA = Open; (for I^2C , active, read and write states)			1	mA
I_{SB}	V_{CC} current (standby)	$V_{CC} = +5.5\text{V}$, I^2C interface in standby state			5	μA
		$V_{CC} = +3.6\text{V}$, I^2C interface in standby state			2	μA
I_{LkgDig}	Leakage current, at pins A0, A1, SDA, and SCL	Voltage at pin from GND to V_{CC}	-10		10	μA
t_{DCP} (Note 15)	DCP wiper response time	SCL falling edge of last bit of DCP data byte to wiper change			1	μs
SERIAL INTERFACE SPECS						
V_{IL}	A1, A0, SDA, and SCL input buffer LOW voltage		-0.3		$0.3 \cdot V_{CC}$	V
V_{IH}	A1, A0, SDA, and SCL input buffer HIGH voltage		$0.7 \cdot V_{CC}$		$V_{CC} + 0.3$	V
Hysteresis (Note 15)	SDA and SCL input buffer hysteresis		$0.05 \cdot V_{CC}$			V
V_{OL} (Note 15)	SDA output buffer LOW voltage, sinking 4mA		0		0.4	V
C_{pin} (Note 15)	A1, A0, SDA, and SCL pin capacitance				10	pF
f_{SCL}	SCL frequency				400	kHz
t_{IN} (Note 15)	Pulse width suppression time at SDA and SCL inputs	Any pulse narrower than the max spec is suppressed			50	ns
t_{AA} (Note 15)	SCL falling edge to SDA output data valid	SCL falling edge crossing 30% of V_{CC} , until SDA exits the 30% to 70% of V_{CC} window			900	ns
t_{BUF} (Note 15)	Time the bus must be free before the start of a new transmission	SDA crossing 70% of V_{CC} during a STOP condition, to SDA crossing 70% of V_{CC} during the following START condition	1300			ns
t_{LOW}	Clock LOW time	Measured at the 30% of V_{CC} crossing	1300			ns
t_{HIGH}	Clock HIGH time	Measured at the 70% of V_{CC} crossing	600			ns
$t_{SU:STA}$	START condition setup time	SCL rising edge to SDA falling edge; both crossing 70% of V_{CC}	600			ns
$t_{HD:STA}$	START condition hold time	From SDA falling edge crossing 30% of V_{CC} to SCL falling edge crossing 70% of V_{CC}	600			ns
$t_{SU:DAT}$	Input data setup time	From SDA exiting the 30% to 70% of V_{CC} window, to SCL rising edge crossing 30% of V_{CC}	100			ns
$t_{HD:DAT}$	Input data hold time	From SCL rising edge crossing 70% of V_{CC} to SDA entering the 30% to 70% of V_{CC} window	0			ns
$t_{SU:STO}$	STOP condition setup time	From SCL rising edge crossing 70% of V_{CC} , to SDA rising edge crossing 30% of V_{CC}	600			ns
$t_{HD:STO}$	STOP condition hold time for read, or volatile only write	From SDA rising edge to SCL falling edge; both crossing 70% of V_{CC}	600			ns
t_{DH} (Note 15)	Output data hold time	From SCL falling edge crossing 30% of V_{CC} , until SDA enters the 30% to 70% of V_{CC} window	0			ns
t_R (Note 15)	SDA and SCL rise time	From 30% to 70% of V_{CC}	$20 + 0.1 \cdot C_b$		250	ns

Operating Specifications Over the recommended operating conditions unless otherwise specified. **(Continued)**

SYMBOL	PARAMETER	TEST CONDITIONS	MIN	TYP (NOTE 1)	MAX	UNIT
t_F (Note 15)	SDA and SCL fall time	From 70% to 30% of V_{CC}	$20 + 0.1 * C_b$		250	ns
C_b (Note 15)	Capacitive loading of SDA or SCL	Total on-chip and off-chip	10		400	pF
R_{pu} (Note 15)	SDA and SCL bus pull-up resistor off-chip	Maximum is determined by t_R and t_F For $C_b = 400\text{pF}$, max is about 2~2.5k Ω For $C_b = 40\text{pF}$, max is about 15~20k Ω	1			k Ω
$t_{SU:A}$	A1 and A0 setup time	Before START condition	600			ns
$t_{HD:A}$	A1 and A0 hold time	After STOP condition	600			ns

SDA vs SCL Timing

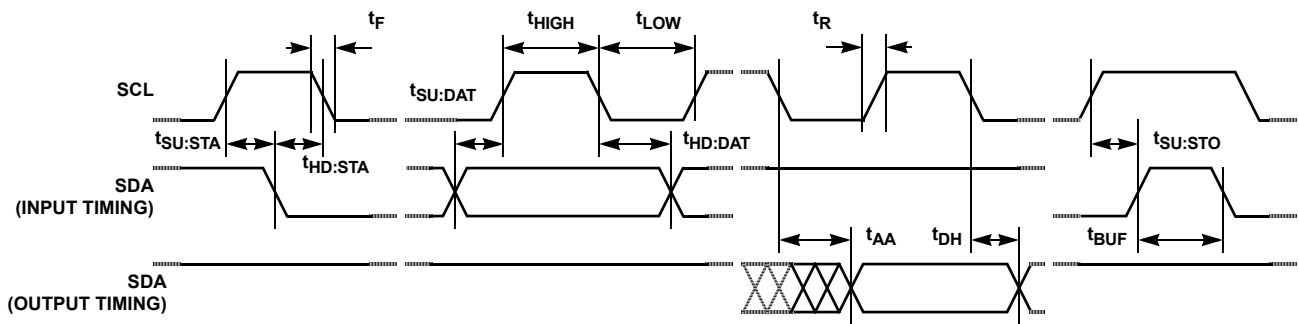

A0 and A1 Pin Timing

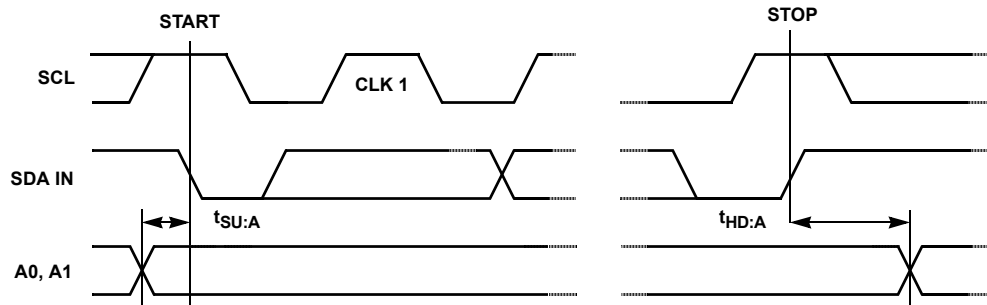

NOTES:

1. Typical values are for $T_A = 25^\circ\text{C}$ and 3.3V supply voltage.
2. LSB: $[V(R_W)_{255} - V(R_W)_0]/255$. $V(R_W)_{255}$ and $V(R_W)_0$ are $V(R_W)$ for the DCP register set to FF hex and 00 hex respectively. LSB is the incremental voltage when changing from one tap to an adjacent tap.
3. ZS error = $V(R_W)_0/\text{LSB}$.
4. FS error = $[V(R_W)_{255} - V_{CC}]/\text{LSB}$.
5. DNL = $[V(R_W)_i - V(R_W)_{i-1}]/\text{LSB} - 1$, for $i = 1$ to 255. i is the DCP register setting.
6. INL = $V(R_W)_i - i \cdot \text{LSB} - V(R_W)$ for $i = 1$ to 255.
7. $V_{\text{MATCH}} = [V(R_W)_x - V(R_W)_y]/\text{LSB}$, for $i = 0$ to 255, $x = 0$ to 3 and $y = 0$ to 3.
8. $TC_V = \frac{\text{Max}(V(R_W)_i) - \text{Min}(V(R_W)_i)}{[\text{Max}(V(R_W)_i) + \text{Min}(V(R_W)_i)]/2} \times \frac{10^6}{125^\circ\text{C}}$ for $i = 16$ to 240 decimal, $T = -40^\circ\text{C}$ to 85°C . $\text{Max}()$ is the maximum value of the wiper voltage and $\text{Min}()$ is the minimum value of the wiper voltage over the temperature range.
9. $MI = |R_{255} - R_0|/255$. R_{255} and R_0 are the measured resistances for the DCP register set to FF hex and 00 hex respectively.
10. $R_{\text{offset}} = R_0/MI$, when measuring between R_W and GND.
 $R_{\text{offset}} = R_{255}/MI$, when measuring between R_W and R_H .
11. $RDNL = (R_i - R_{i-1})/MI$, for $i = 32$ to 255.
12. $RINL = [R_i - (MI \cdot i) - R_0]/MI$, for $i = 32$ to 255.
13. $R_{\text{MATCH}} = (R_{i,x} - R_{i,y})/MI$, for $i = 0$ to 255, $x = 0$ to 3 and $y = 0$ to 3.
14. $TC_R = \frac{[\text{Max}(R_i) - \text{Min}(R_i)]}{[\text{Max}(R_i) + \text{Min}(R_i)]/2} \times \frac{10^6}{125^\circ\text{C}}$ for $i = 32$ to 255, $T = -40^\circ\text{C}$ to 85°C . $\text{Max}()$ is the maximum value of the resistance and $\text{Min}()$ is the minimum value of the resistance over the temperature range.
15. This parameter is not 100% tested.

Typical Performance Curves

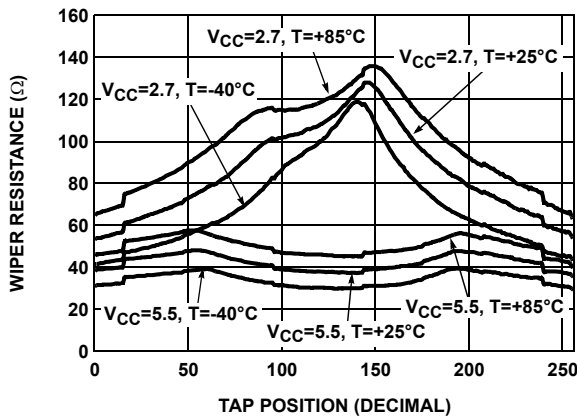

FIGURE 1. WIPER RESISTANCE vs TAP POSITION
 $[I(R_W) = V_{CC} / R_{\text{TOTAL}}]$ FOR $50\text{k}\Omega$ (U)

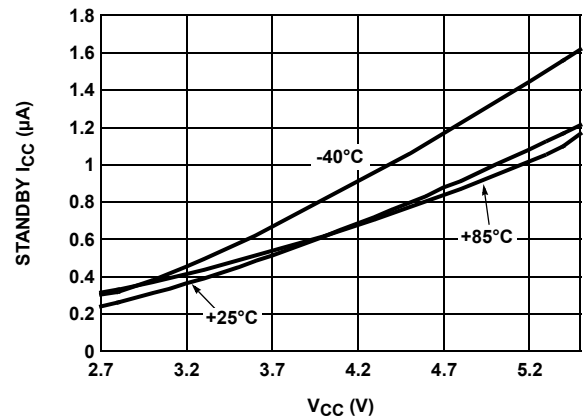

FIGURE 2. STANDBY I_{CC} vs V_{CC}

Typical Performance Curves (Continued)

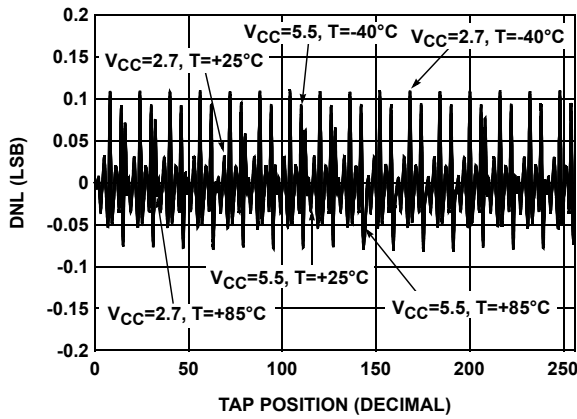

FIGURE 3. DNL vs TAP POSITION IN VOLTAGE DIVIDER MODE FOR 10kΩ (W)

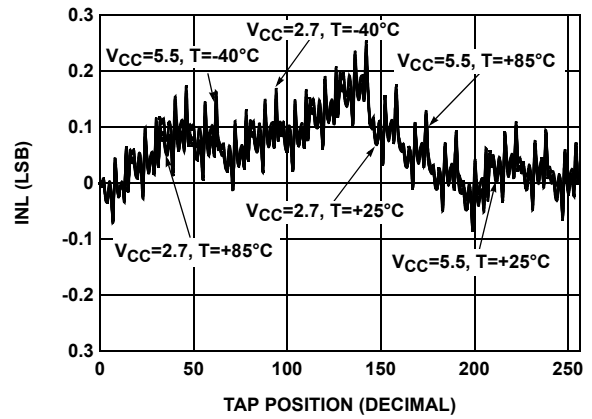

FIGURE 4. INL vs TAP POSITION IN VOLTAGE DIVIDER MODE FOR 10kΩ (W)

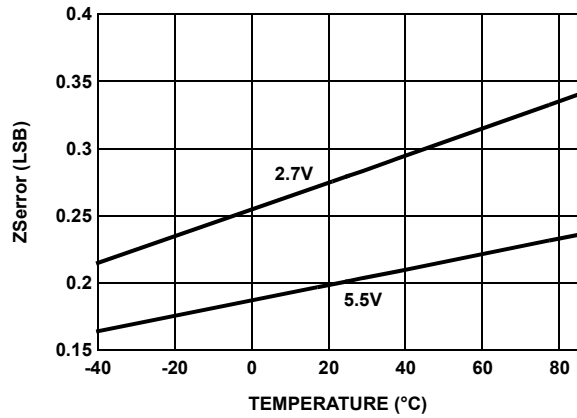

FIGURE 5. ZSerror vs TEMPERATURE FOR 50kΩ (U)

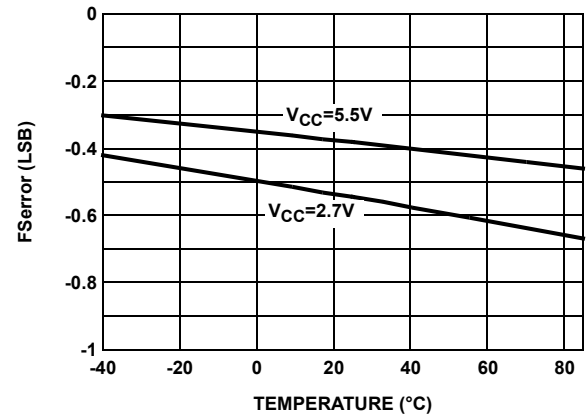

FIGURE 6. FSerror vs TEMPERATURE FOR 50kΩ (U)

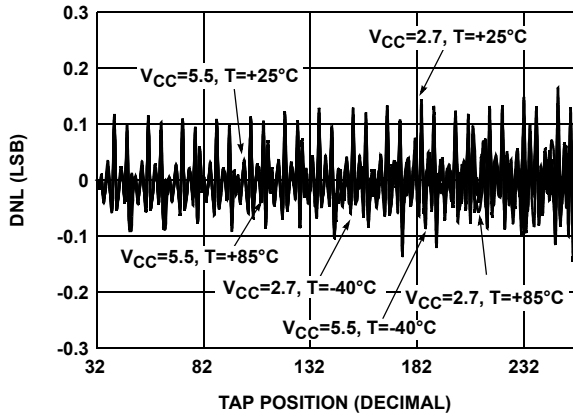

FIGURE 7. DNL vs TAP POSITION IN RHEOSTAT MODE FOR 50kΩ (U)

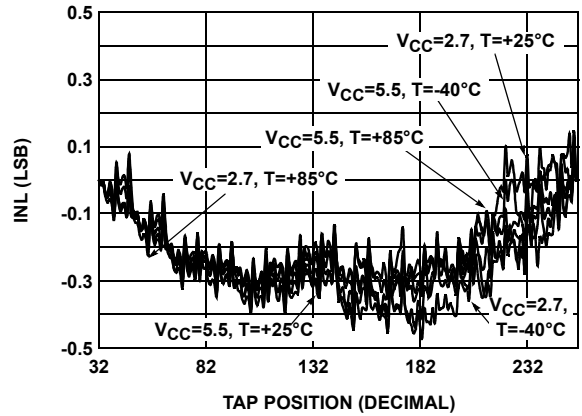

FIGURE 8. INL vs TAP POSITION IN RHEOSTAT MODE FOR 50kΩ (U)

Typical Performance Curves (Continued)

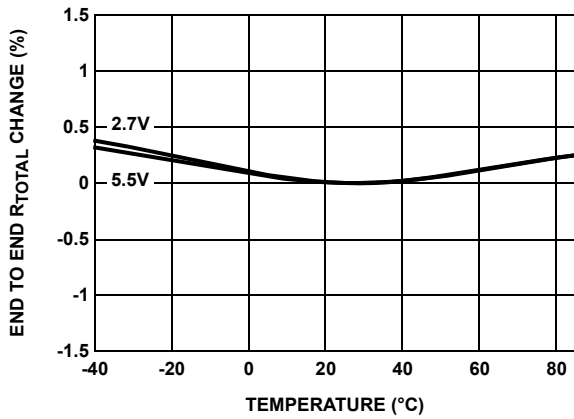

FIGURE 9. END TO END R_{TOTAL} % CHANGE vs TEMPERATURE FOR 10kΩ (W)

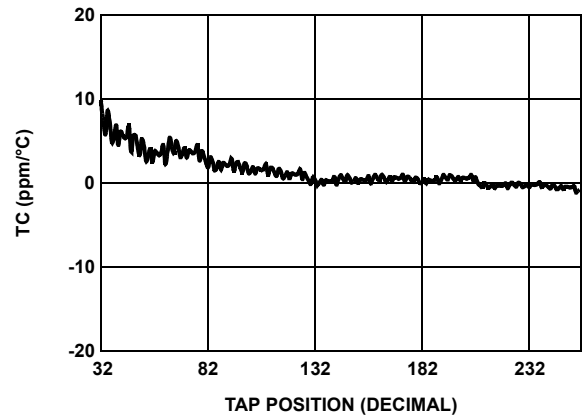

FIGURE 10. TC FOR VOLTAGE DIVIDER MODE IN ppm

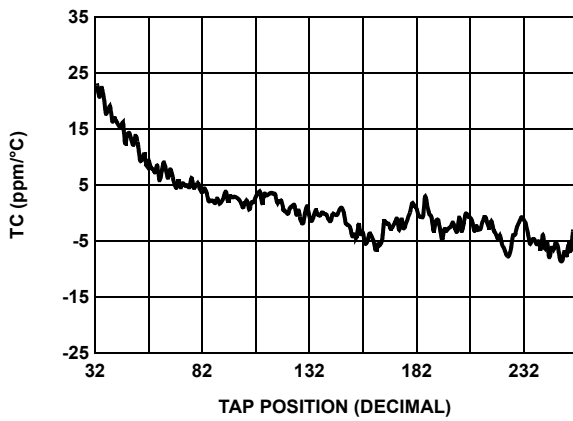

FIGURE 11. TC FOR RHEOSTAT MODE IN ppm

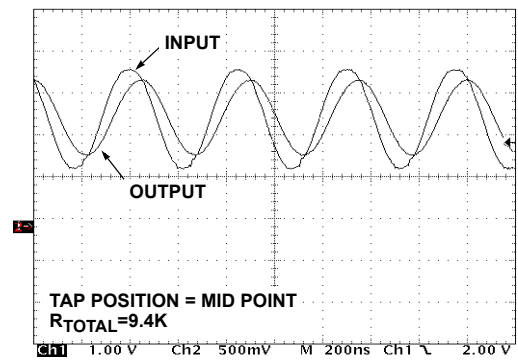

FIGURE 12. FREQUENCY RESPONSE (2.2MHz)

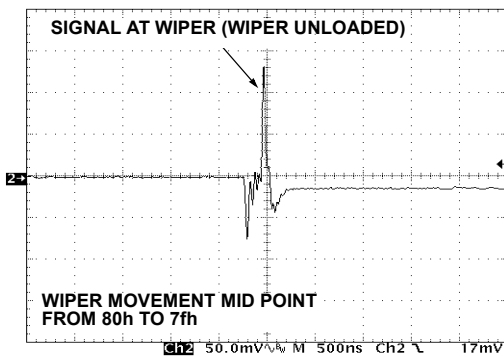

FIGURE 13. MIDSCALE GLITCH, CODE 80h to 7Fh (WIPER 0)

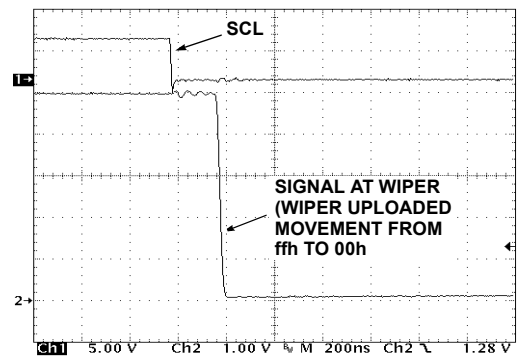

FIGURE 14. LARGE SIGNAL SETTLING TIME

Principles of Operation

The ISL90841 is an integrated circuit incorporating four DCPs with their associated registers, and an I²C serial interface providing direct communication between a host and the potentiometers.

DCP Description

Each DCP is implemented with a combination of resistor elements and CMOS switches. The physical ends of each DCP are equivalent to the fixed terminals of a mechanical potentiometer (R_H and GND). The R_W pin of each DCP is connected to intermediate nodes, and is equivalent to the wiper terminal of a mechanical potentiometer. The position of the wiper terminal within the DCP is controlled by an 8-bit volatile Wiper Register (WR). Each DCP has its own WR. When the WR of a DCP contains all zeroes (WR<7:0>: 00h), its wiper terminal (R_W) is closest to its “Low” terminal (GND). When the WR of a DCP contains all ones (WR<7:0>: FFh), its wiper terminal (R_W) is closest to its “High” terminal (R_H). As the value of the WR increases from all zeroes (00h) to all ones (255 decimal), the wiper moves monotonically from the position closest to GND to the closest to R_H. At the same time, the resistance between R_W and GND increases monotonically, while the resistance between R_H and R_W decreases monotonically.

While the ISL90841 is being powered up, all four WRs are reset to 80h (128 decimal), which locates R_W roughly at the center between GND and R_H.

The WRs can be read or written directly using the I²C serial interface as described in the following sections. The I²C interface Address Byte has to be set to 00h, 01h, 02h, and 03h to access the WR of DCP0, DCP1, DCP2, and DCP3 respectively.

I²C Serial Interface

The ISL90841 supports a bidirectional bus oriented protocol. The protocol defines any device that sends data onto the bus as a transmitter and the receiving device as the receiver. The device controlling the transfer is a master and the device being controlled is the slave. The master always initiates data transfers and provides the clock for both transmit and receive operations. Therefore, the ISL90841 operates as a slave device in all applications.

All communication over the I²C interface is conducted by sending the MSB of each byte of data first.

Protocol Conventions

Data states on the SDA line must change only during SCL LOW periods. SDA state changes during SCL HIGH are reserved for indicating START and STOP conditions (See Figure 15). On power-up of the ISL90841 the SDA pin is in the input mode.

All I²C interface operations must begin with a START condition, which is a HIGH to LOW transition of SDA while SCL is HIGH. The ISL90841 continuously monitors the SDA and SCL lines for the START condition and does not respond to any command until this condition is met (See Figure 15). A START condition is ignored during the power-up of the device.

All I²C interface operations must be terminated by a STOP condition, which is a LOW to HIGH transition of SDA while SCL is HIGH (See Figure 15). A STOP condition at the end of a read operation, or at the end of a write operation places the device in its standby mode.

An ACK, Acknowledge, is a software convention used to indicate a successful data transfer. The transmitting device, either master or slave, releases the SDA bus after transmitting eight bits. During the ninth clock cycle, the receiver pulls the SDA line LOW to acknowledge the reception of the eight bits of data (See Figure 16).

The ISL90841 responds with an ACK after recognition of a START condition followed by a valid Identification Byte, and once again after successful receipt of an Address Byte. The ISL90841 also responds with an ACK after receiving a Data Byte of a write operation. The master must respond with an ACK after receiving a Data Byte of a read operation.

A valid Identification Byte contains 01010 as the five MSBs, and the following two bits matching the logic values present at pins A1 and A0. The LSB is the Read/Write bit. Its value is “1” for a Read operation, and “0” for a Write operation (See Table 1).

TABLE 1. IDENTIFICATION BYTE FORMAT

Logic values at pins A1 and A0 respectively

0	1	0	1	0	A1	A0	R \bar{W}
(MSB)							(LSB)

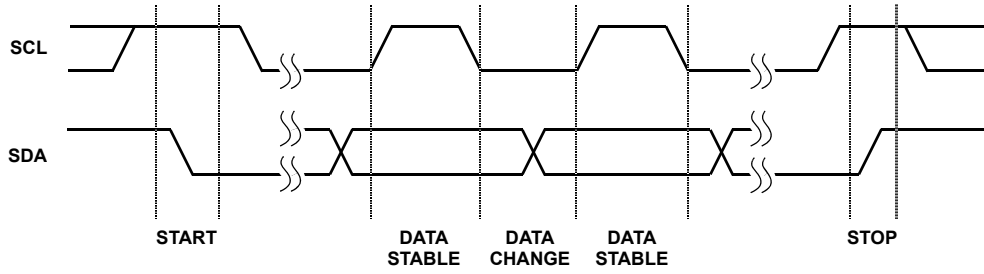

FIGURE 15. VALID DATA CHANGES, START, AND STOP CONDITIONS

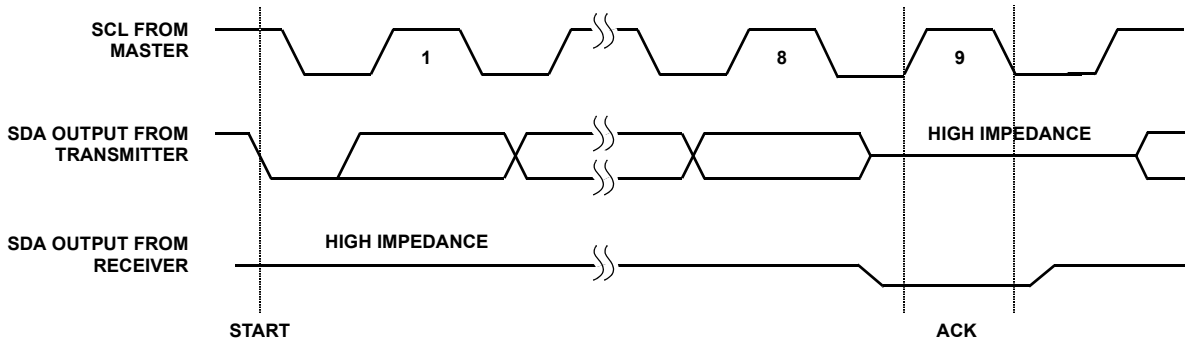

FIGURE 16. ACKNOWLEDGE RESPONSE FROM RECEIVER

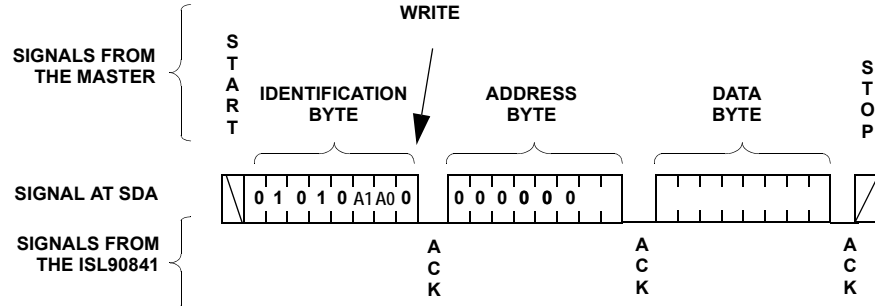

FIGURE 17. BYTE WRITE SEQUENCE

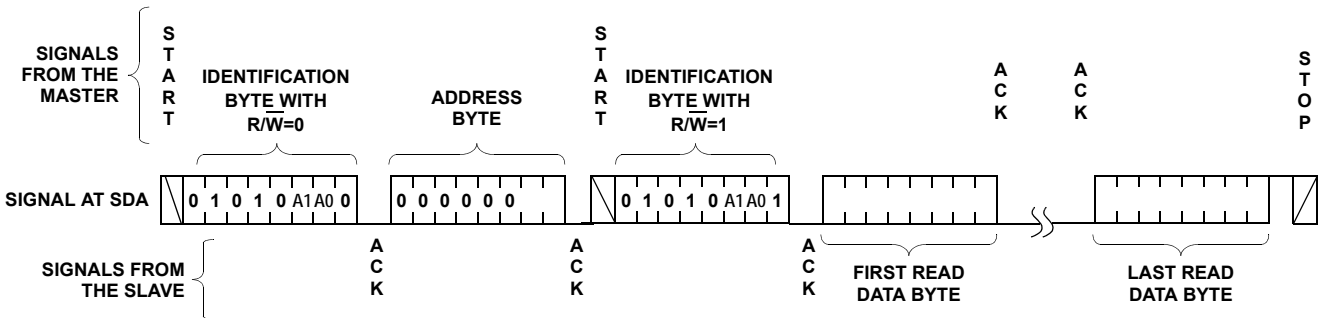

FIGURE 18. READ SEQUENCE

Write Operation

A Write operation requires a START condition, followed by a valid Identification Byte, a valid Address Byte, a Data Byte, and a STOP condition. After each of the three bytes, the ISL90841 responds with an ACK. At this time, the device enters its standby state (See Figure 17).

Read Operation

A Read operation consist of a three byte instruction followed by one or more Data Bytes (See Figure 18). The master initiates the operation issuing the following sequence: a START, the Identification byte with the R/W bit set to "0", an Address Byte, a second START, and a second Identification byte with the R/W bit set to "1". After each of the three bytes, the ISL90841 responds with an ACK. Then the ISL90841 transmits Data Bytes as long as the master responds with an ACK during the SCL cycle following the eighth bit of each byte. The master terminates the read operation (issuing a STOP condition) following the last bit of the last Data Byte (See Figure 18).

The Data Bytes are from the registers indicated by an internal pointer. This pointer initial value is determined by the Address Byte in the Read operation instruction, and increments by one during transmission of each Data Byte. After reaching the memory location 03h the pointer "rolls over" to 00h, and the device continues to output data for each ACK received.

© Copyright Intersil Americas LLC 2005-2006. All Rights Reserved.
All trademarks and registered trademarks are the property of their respective owners.

For additional products, see www.intersil.com/en/products.html

Intersil products are manufactured, assembled and tested utilizing ISO9001 quality systems as noted in the quality certifications found at www.intersil.com/en/support/qualandreliability.html

Intersil products are sold by description only. Intersil may modify the circuit design and/or specifications of products at any time without notice, provided that such modification does not, in Intersil's sole judgment, affect the form, fit or function of the product. Accordingly, the reader is cautioned to verify that datasheets are current before placing orders. Information furnished by Intersil is believed to be accurate and reliable. However, no responsibility is assumed by Intersil or its subsidiaries for its use; nor for any infringements of patents or other rights of third parties which may result from its use. No license is granted by implication or otherwise under any patent or patent rights of Intersil or its subsidiaries.

For information regarding Intersil Corporation and its products, see www.intersil.com

Packaging Information

14-Lead Plastic, TSSOP, Package Code V14

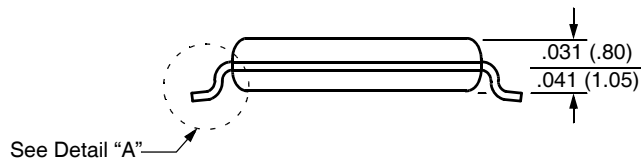
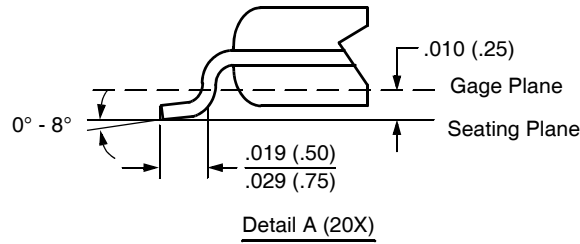
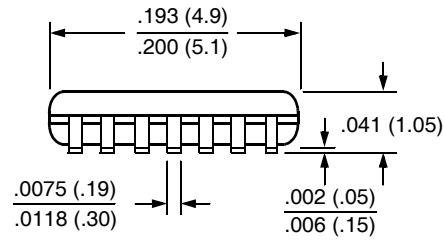
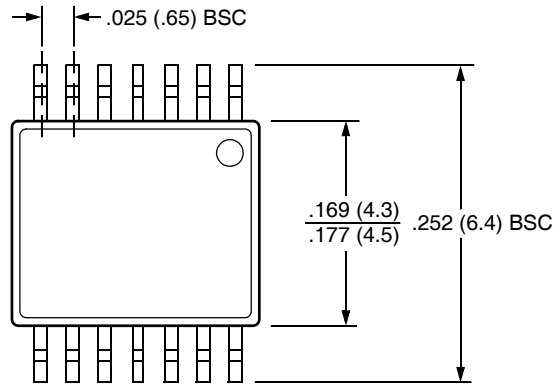

NOTE: ALL DIMENSIONS IN INCHES (IN PARENTHESES IN MILLIMETERS)



Компания «ЭлектроПласт» предлагает заключение долгосрочных отношений при поставках импортных электронных компонентов на взаимовыгодных условиях!

Наши преимущества:

- Оперативные поставки широкого спектра электронных компонентов отечественного и импортного производства напрямую от производителей и с крупнейших мировых складов;
- Поставка более 17-ти миллионов наименований электронных компонентов;
- Поставка сложных, дефицитных, либо снятых с производства позиций;
- Оперативные сроки поставки под заказ (от 5 рабочих дней);
- Экспресс доставка в любую точку России;
- Техническая поддержка проекта, помощь в подборе аналогов, поставка прототипов;
- Система менеджмента качества сертифицирована по Международному стандарту ISO 9001;
- Лицензия ФСБ на осуществление работ с использованием сведений, составляющих государственную тайну;
- Поставка специализированных компонентов (Xilinx, Altera, Analog Devices, Intersil, Interpoint, Microsemi, Aeroflex, Peregrine, Syfer, Eurofarad, Texas Instrument, Miteq, Cobham, E2V, MA-COM, Hittite, Mini-Circuits, General Dynamics и др.);

Помимо этого, одним из направлений компании «ЭлектроПласт» является направление «Источники питания». Мы предлагаем Вам помощь Конструкторского отдела:

- Подбор оптимального решения, техническое обоснование при выборе компонента;
- Подбор аналогов;
- Консультации по применению компонента;
- Поставка образцов и прототипов;
- Техническая поддержка проекта;
- Защита от снятия компонента с производства.



Как с нами связаться

Телефон: 8 (812) 309 58 32 (многоканальный)

Факс: 8 (812) 320-02-42

Электронная почта: org@eplast1.ru

Адрес: 198099, г. Санкт-Петербург, ул. Калинина, дом 2, корпус 4, литера А.