



### FEATURES

- Single isolated output
- 1kVDC Isolation
- Efficiency up to 88%
- Power density 1.8W/cm<sup>3</sup>
- Wide temperature performance at full 1 Watt load, -40°C to 85°C
- UL 94V-0 Package material
- Footprint over pins 1.37cm<sup>2</sup>
- 3.3V, 5V, 12V, 15V & 24V Input
- 3.3V, 5V, 9V, 12V & 15V Output
- Internal SMD construction
- Toroidal magnetics

### PRODUCT OVERVIEW

The MTE1 series is a new range of surface mount, high performance 1W DC-DC converters. The MTE1 series is the new high performance version of our 1W NTE series, the MTE1 series is more efficient and offers improved regulation performance. The MTE1 series offers 1W of available output power over the full industrial temperature range of -40°C to 85°C.

The MTE1 series has a MSL rating 1, and is compatible with a peak reflow solder temperature of 245°C as per J-STD-020D.

### SELECTION GUIDE

Order Code <sup>1</sup>	Nominal Input Voltage	Output Voltage	Output Current	Input Current at Rated Load (Typ.)	Load Regulation (Typ.)	Load Regulation (Max)	Output Ripple & Noise (Typ.)	Efficiency (Min.)	Efficiency (Typ.)	Isolation Capacitance	MTTF <sup>2</sup>
	V	V	mA	mA	%	%	mVp-p	%	%	pF	kHrs
MTE1S0303MC	3.3	3.3	303	382	11	13.5	33	75	78	15	
MTE1S0305MC	3.3	5	200	363	8.5	11	24	79	82	16	
MTE1S0309MC	3.3	9	111	353	7	9	17	82	85	21	
MTE1S0312MC	3.3	12	83	348	6.5	8	15	83	86	20	
MTE1S0315MC	3.3	15	66	346	6	8	13	83	86	20	
MTE1S0503MC	5	3.3	303	248	9	12	24	77	79	21	
MTE1S0505MC	5	5	200	239	6.5	8	20	79	82	22	
MTE1S0506MC	5	6	TBC	236	6	7.5	20	81	83	24	
MTE1S0509MC	5	9	111	233	5	6.5	15	83	85	26	
MTE1S0512MC	5	12	83	227	5	6.5	14	84	87	29	
MTE1S0515MC	5	15	66	225	5	6.5	11	85	88	33	
MTE1S1205MC	12	5	200	97	5	7	19	81	84	34	
MTE1S1209MC	12	9	111	95	3	4.5	13	82	86	39	
MTE1S1212MC	12	12	83	93	3	4.5	12	85	88	43	
MTE1S1215MC	12	15	66	93	3	4	11	85	88	40	
MTE1S1505MC	15	5	200	79	4	5.5	15	80	83	25	
MTE1S1509MC	15	9	111	77	3	4	9	81	86	38	
MTE1S1512MC	15	12	83	76	2.5	4	10	82	87	45	
MTE1S1515MC	15	15	66	75	2.5	4	8	84	88	57	
MTE1S2405MC	24	5	200	50	4	5.5	20	79	83	21	
MTE1S2409MC	24	9	111	48	2.5	4	19	84	86	31	
MTE1S2412MC	24	12	83	48	2	3.5	19	83	87	41	
MTE1S2415MC	24	15	66	48	2	3.5	22	85	88	48	

### INPUT CHARACTERISTICS

Parameter	Conditions	Min.	Typ.	Max.	Units
Voltage range	Continuous operation, 3.3V input types	2.97	3.3	3.63	V
	Continuous operation, 5V input types	4.5	5.0	5.5	
	Continuous operation, 12V input types	10.8	12.0	13.2	
	Continuous operation, 15V input types	13.5	15.0	16.5	
	Continuous operation, 24V input types	21.6	24	26.4	
Reflected ripple current			5	15	mA p-p

### ISOLATION CHARACTERISTICS

Parameter	Conditions	Min.	Typ.	Max.	Units
Isolation voltage	Flash tested for 1 second	1000			VDC
Resistance	Viso= 1000VDC	20			GΩ

### GENERAL CHARACTERISTICS

Parameter	Conditions	Min.	Typ.	Max.	Units
Switching frequency	All output types		80		Hz

### ABSOLUTE MAXIMUM RATINGS

Lead temperature 1.5mm from case for 10 seconds	300°C
Internal power dissipation	600mW
Input voltage V <sub>IN</sub> , MTE03 types	5.5V
Input voltage V <sub>IN</sub> , MTE05 types	7V
Input voltage V <sub>IN</sub> , MTE12 types	15V
Input voltage V <sub>IN</sub> , MTE15 types	18V
Input voltage V <sub>IN</sub> , MTE24 types	28V

1. If components are required in tape and reel format suffix order code with -R, e.g. MTE0505MC-R.
2. Calculated using MIL-HDBK-217 FN2 calculation model with nominal input voltage at full load.  
All specifications typical at T<sub>A</sub>=25°C, nominal input voltage and rated output current unless otherwise specified.



**OUTPUT CHARACTERISTICS**

Parameter	Conditions	Min.	Typ.	Max.	Units
Rated power	T <sub>A</sub> =-40°C to 85°C			1.0	W
Voltage set point accuracy	See tolerance envelope				
Line regulation	High V <sub>IN</sub> to low V <sub>IN</sub>		1.1	1.2	%/%
Ripple and noise	BW=DC to 20MHz		25	70	mV p-p

**TEMPERATURE CHARACTERISTICS**

Parameter	Conditions	Min.	Typ.	Max.	Units
Specification	All output types	-40		85	°C
Storage		-50		130	
Case temperature rise above ambient	All output types		12.5	20	
Cooling	Free air convection				

**TECHNICAL NOTES**

**ISOLATION VOLTAGE**

'Hi Pot Test', 'Flash Tested', 'Withstand Voltage', 'Proof Voltage', 'Dielectric Withstand Voltage' & 'Isolation Test Voltage' are all terms that relate to the same thing, a test voltage, applied for a specified time, across a component designed to provide electrical isolation, to verify the integrity of that isolation.

Murata Power Solutions MTE series of DC/DC converters are all 100% production tested at their stated isolation voltage. This is 1kVDC for 1 second.

A question commonly asked is, "What is the continuous voltage that can be applied across the part in normal operation?"

For a part holding no specific agency approvals, such as the MTE series, both input and output should normally be maintained within SELV limits i.e. less than 42.4V peak, or 60VDC. The isolation test voltage represents a measure of immunity to transient voltages and the part should never be used as an element of a safety isolation system. The part could be expected to function correctly with several hundred volts offset applied continuously across the isolation barrier; but then the circuitry on both sides of the barrier must be regarded as operating at an unsafe voltage and further isolation/insulation systems must form a barrier between these circuits and any user-accessible circuitry according to safety standard requirements.

**REPEATED HIGH-VOLTAGE ISOLATION TESTING**

It is well known that repeated high-voltage isolation testing of a barrier component can actually degrade isolation capability, to a lesser or greater degree depending on materials, construction and environment. The MTE series has toroidal isolation transformers, with no additional insulation between primary and secondary windings of enameled wire. While parts can be expected to withstand several times the stated test voltage, the isolation capability does depend on the wire insulation. Any material, including this enamel (typically polyurethane) is susceptible to eventual chemical degradation when subject to very high applied voltages thus implying that the number of tests should be strictly limited. We therefore strongly advise against repeated high voltage isolation testing, but if it is absolutely required, that the voltage be reduced by 20% from specified test voltage.

This consideration equally applies to agency recognized parts rated for better than functional isolation where the wire enamel insulation is always supplemented by a further insulation system of physical spacing or barriers.

**TEMPERATURE DERATING GRAPH**

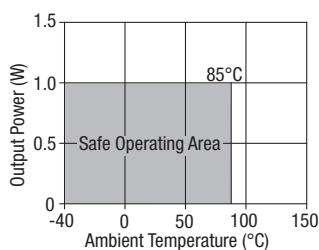

1. 12V input types have typically 3% less load regulation change.

**TOLERANCE ENVELOPES**

The voltage tolerance envelope shows typical load regulation characteristics for this product series. The tolerance envelope is the maximum output voltage variation due to changes in output loading.

**0303, 0503**

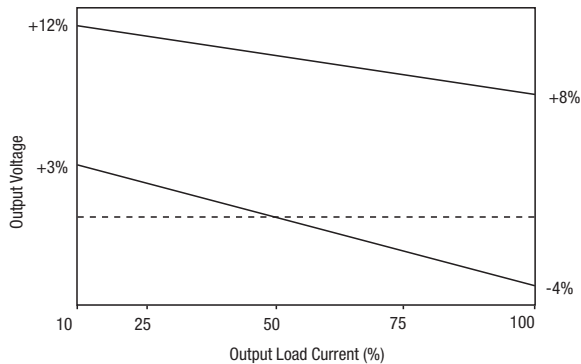

**0305, 0309**

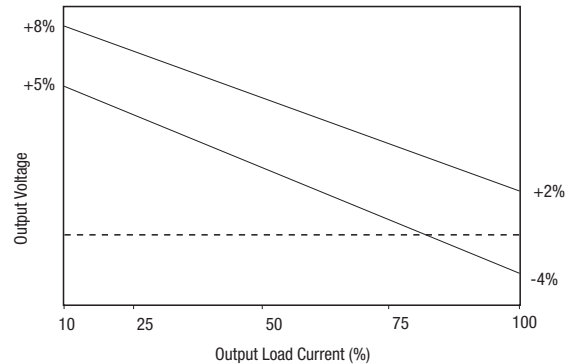

**0312, 0315, 0505, 0506, 0509**

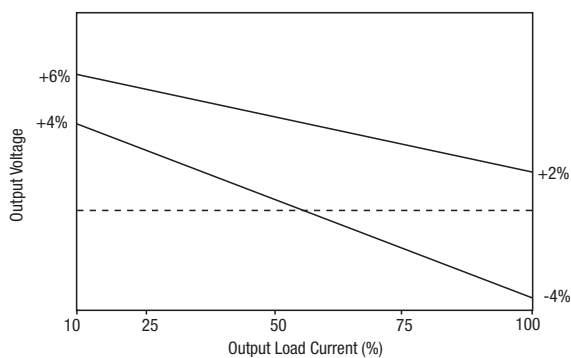

**1209, 1212, 1505**

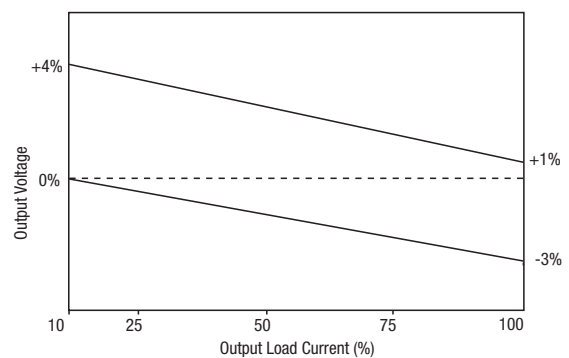

**0512, 0515, 1205, 2405**

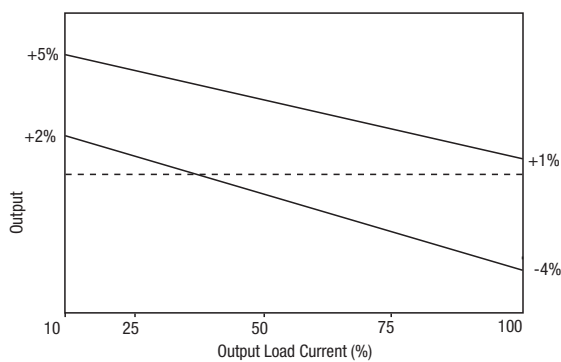

**1215, 1509, 1512, 1515, 2409, 2412, 2415**

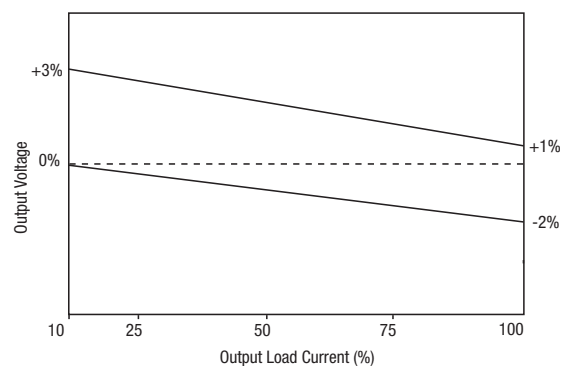

### EFFICIENCY VS LOAD

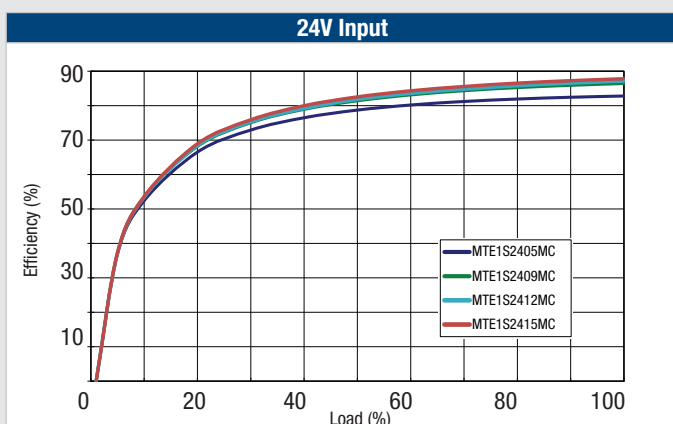
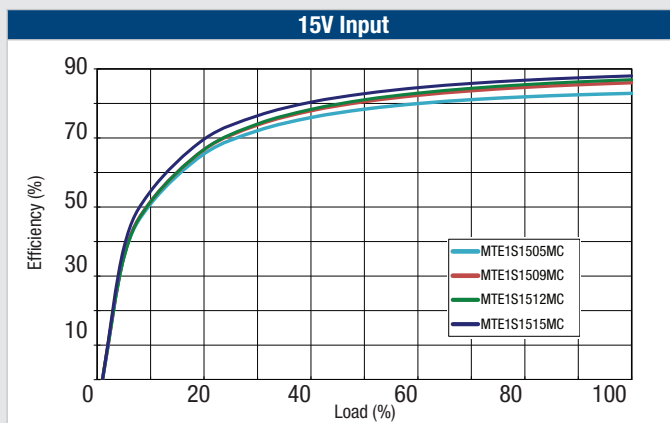
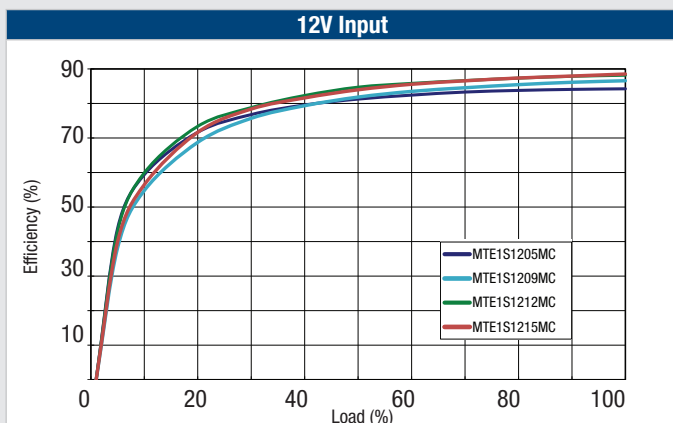
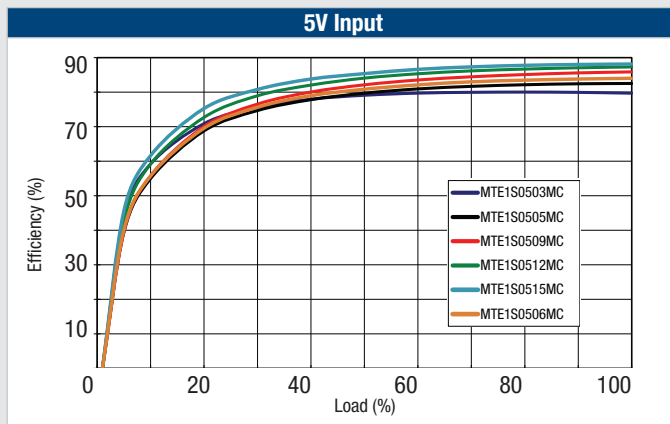
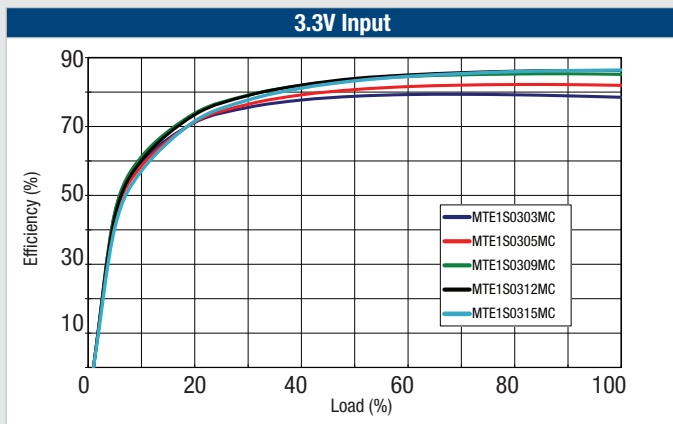

### RoHS COMPLIANCE, MSL AND PSL INFORMATION



This series is compatible with RoHS soldering systems with a peak reflow solder temperature of 245°C as per J-STD-020D. The pin termination finish on this product series is Matte Tin over Nickel Preplate. The series is backward compatible with Sn/Pb soldering systems. The series has a Moisture Sensitivity Level (MSL) 1.

Samples of the product series were tested in accordance with the conditioning described for MSL level 1 in IPS/J-STD-020D. The product series passed electrical tests and visual inspection criteria.

For further information, please visit: [www.murata-ps.com/rohs](http://www.murata-ps.com/rohs)

**APPLICATION NOTES**

**Minimum load**

The minimum load to meet datasheet specification is 10% of the full rated load across the specified input voltage range. Lower than 10% minimum loading will result in an increase in output voltage, which may rise to typically double the specified output voltage if the output load falls to less than 5%.

**Capacitive loading and start up**

Typical start up times for this series, with a typical input voltage rise time of 2.2µs and output capacitance of 10µF, are shown in the table below. The product series will start into a capacitance of 47µF with an increased start time, however, the maximum recommended output capacitance is 10µF.

	Start-up time µs		Start-up time µs		Start-up time µs
MTE1S0303MC		MTE1S0509MC		MTE1S1509MC	
MTE1S0305MC		MTE1S0512MC		MTE1S1512MC	
MTE1S0309MC		MTE1S0515MC		MTE1S1515MC	
MTE1S0312MC		MTE1S1205MC		MTE1S2405MC	
MTE1S0315MC		MTE1S1209MC		MTE1S2409MC	
MTE1S0503MC		MTE1S1212MC		MTE1S2412MC	
MTE1S0505MC		MTE1S1215MC		MTE1S2415MC	
MTE1S0506MC		MTE1S1505MC			

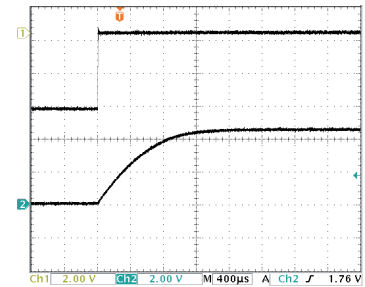

**Output Ripple Reduction**

By using the values of inductance and capacitance stated, the output ripple at the rated load is lowered to 5mV p-p max.

**Component selection**

**Capacitor:** It is required that the ESR (Equivalent Series Resistance) should be as low as possible, ceramic types are recommended. The voltage rating should be at least twice (except for 15V output), the rated output voltage of the DC/DC converter.

**Inductor:** The rated current of the inductor should not be less than that of the output of the DC/DC converter. At the rated current, the DC resistance of the inductor should be such that the voltage drop across the inductor is <2% of the rated voltage of the DC/DC converter. The SRF (Self Resonant Frequency) should be >20MHz.

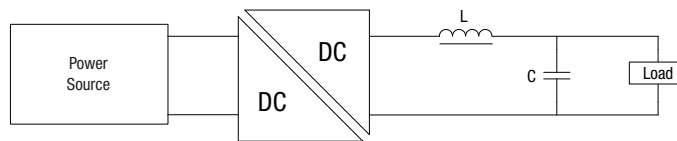

Typical Start-Up Wave Form

	Inductor			Capacitor C, µF
	L, µH	SMD	Through Hole	
MTE1S0303MC				
MTE1S0305MC				
MTE1S0309MC				
MTE1S0312MC				
MTE1S0315MC				
MTE1S0503MC				
MTE1S0505MC				
MTE1S0506MC				
MTE1S0509MC				
MTE1S0512MC				
MTE1S0515MC				
MTE1S1205MC				

	Inductor			Capacitor C, µF
	L, µH	SMD	Through Hole	
MTE1S1209MC				
MTE1S1212MC				
MTE1S1215MC				
MTE1S1505MC				
MTE1S1509MC				
MTE1S1512MC				
MTE1S1515MC				
MTE1S2405MC				
MTE1S2409MC				
MTE1S2412MC				
MTE1S2415MC				

**PACKAGE SPECIFICATIONS**

**MECHANICAL DIMENSIONS**

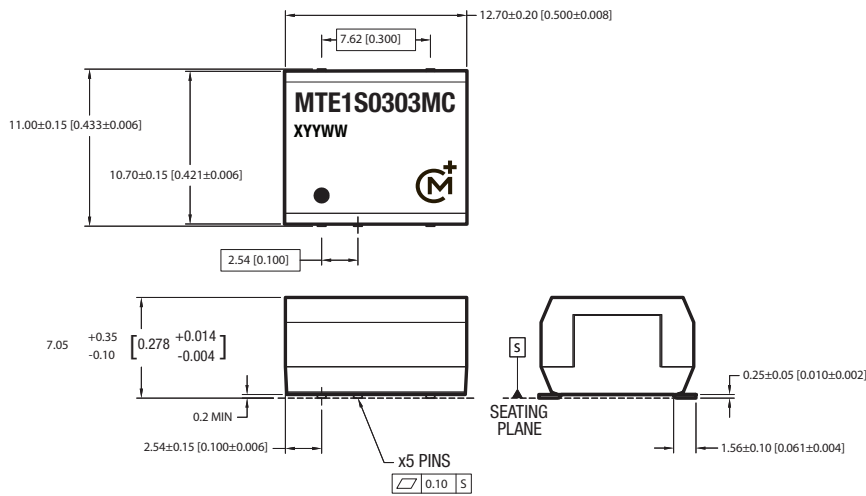

All dimensions in mm ±0.25mm (inches ±0.01). All pins on a 2.54 (0.1) pitch and within ± 0.25 (0.01) of true position. Weight: 1.1g

**PIN CONNECTIONS**

Pin	Function
1	-VIN
3	+VIN
5	NA
7	-VOUT
8	+VOUT
10	NA
12	NA
14	NA

NA - Not available for electrical connection.

**RECOMMENDED FOOTPRINT DETAILS**

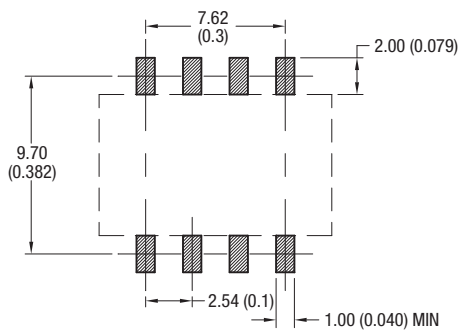

All pins on a 2.54mm pitch. Unless otherwise stated all dimensions in mm (inches) ±0.5mm.

**TUBE OUTLINE DIMENSIONS**

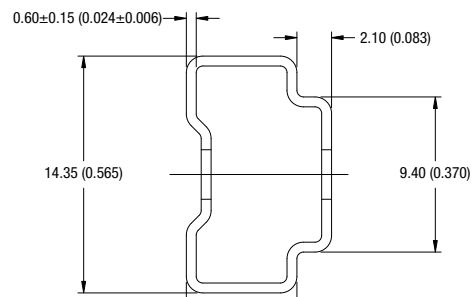

Unless otherwise stated all dimensions in mm (inches) ±0.02. Tube length : 475±2.0 (18.70±0.07).

Tube Quantity : 35

**TAPE & REEL SPECIFICATIONS**

**REEL OUTLINE DIMENSIONS**

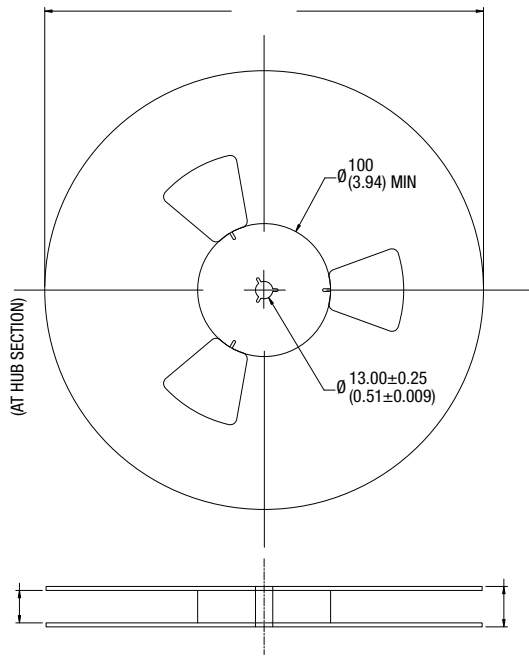

**TAPE OUTLINE DIMENSIONS**

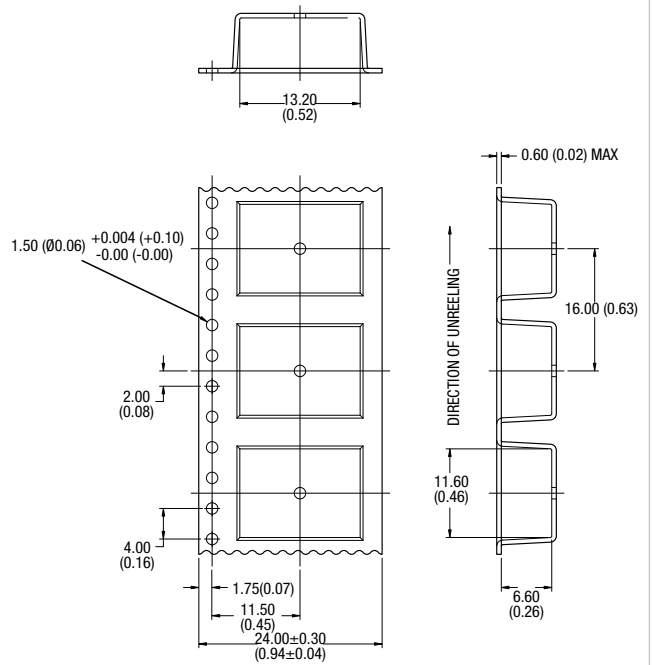

**REEL PACKAGING DETAILS**

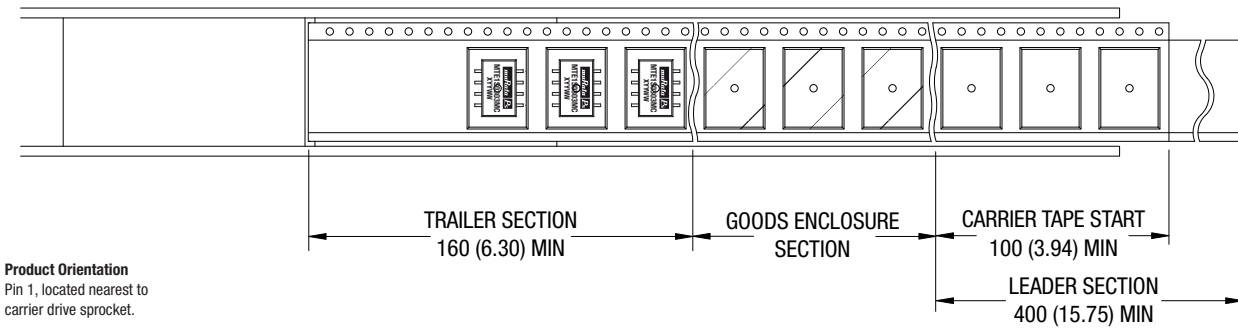

**Product Orientation**  
Pin 1, located nearest to carrier drive sprocket.

Reel Quantity : TBC

Murata Power Solutions, Inc.  
11 Cabot Boulevard, Mansfield, MA 02048-1151 U.S.A.  
ISO 9001 and 14001 REGISTERED

Murata Power Solutions, Inc. makes no representation that the use of its products in the circuits described herein, or the use of other technical information contained herein, will not infringe upon existing or future patent rights. The descriptions contained herein do not imply the granting of licenses to make, use, or sell equipment constructed in accordance therewith. Specifications are subject to change without notice. © 2012 Murata Power Solutions, Inc.



Компания «ЭлектроПласт» предлагает заключение долгосрочных отношений при поставках импортных электронных компонентов на взаимовыгодных условиях!

Наши преимущества:

- Оперативные поставки широкого спектра электронных компонентов отечественного и импортного производства напрямую от производителей и с крупнейших мировых складов;
- Поставка более 17-ти миллионов наименований электронных компонентов;
- Поставка сложных, дефицитных, либо снятых с производства позиций;
- Оперативные сроки поставки под заказ (от 5 рабочих дней);
- Экспресс доставка в любую точку России;
- Техническая поддержка проекта, помощь в подборе аналогов, поставка прототипов;
- Система менеджмента качества сертифицирована по Международному стандарту ISO 9001;
- Лицензия ФСБ на осуществление работ с использованием сведений, составляющих государственную тайну;
- Поставка специализированных компонентов (Xilinx, Altera, Analog Devices, Intersil, Interpoint, Microsemi, Aeroflex, Peregrine, Syfer, Eurofarad, Texas Instrument, Miteq, Cobham, E2V, MA-COM, Hittite, Mini-Circuits, General Dynamics и др.);

Помимо этого, одним из направлений компании «ЭлектроПласт» является направление «Источники питания». Мы предлагаем Вам помощь Конструкторского отдела:

- Подбор оптимального решения, техническое обоснование при выборе компонента;
- Подбор аналогов;
- Консультации по применению компонента;
- Поставка образцов и прототипов;
- Техническая поддержка проекта;
- Защита от снятия компонента с производства.



#### Как с нами связаться

**Телефон:** 8 (812) 309 58 32 (многоканальный)

**Факс:** 8 (812) 320-02-42

**Электронная почта:** [org@eplast1.ru](mailto:org@eplast1.ru)

**Адрес:** 198099, г. Санкт-Петербург, ул. Калинина, дом 2, корпус 4, литера А.