



FEATURES

- Single isolated output
- 1kVDC Isolation
- Efficiency up to 88%
- Power density 1.8W/cm³
- Wide temperature performance at full 1 Watt load, -40°C to 85°C
- UL 94V-0 Package material
- Footprint over pins 1.37cm²
- 3.3V, 5V, 12V, 15V & 24V Input
- 3.3V, 5V, 9V, 12V & 15V Output
- Internal SMD construction
- Toroidal magnetics

PRODUCT OVERVIEW

The MTE1 series is a new range of surface mount, high performance 1W DC-DC converters. The MTE1 series is the new high performance version of our 1W NTE series, the MTE1 series is more efficient and offers improved regulation performance. The MTE1 series offers 1W of available output power over the full industrial temperature range of -40°C to 85°C.

The MTE1 series has a MSL rating 1, and is compatible with a peak reflow solder temperature of 245°C as per J-STD-020D.

SELECTION GUIDE

| Order Code ¹ | Nominal Input Voltage | Output Voltage | Output Current | Input Current at Rated Load (Typ.) | Load Regulation (Typ.) | Load Regulation (Max) | Output Ripple & Noise (Typ.) | Efficiency (Min.) | Efficiency (Typ.) | Isolation Capacitance | MTTF ² |
|-------------------------|-----------------------|----------------|----------------|------------------------------------|------------------------|-----------------------|------------------------------|-------------------|-------------------|-----------------------|-------------------|
| | V | V | mA | mA | % | % | mVp-p | % | % | pF | kHrs |
| MTE1S0303MC | 3.3 | 3.3 | 303 | 382 | 11 | 13.5 | 33 | 75 | 78 | 15 | |
| MTE1S0305MC | 3.3 | 5 | 200 | 363 | 8.5 | 11 | 24 | 79 | 82 | 16 | |
| MTE1S0309MC | 3.3 | 9 | 111 | 353 | 7 | 9 | 17 | 82 | 85 | 21 | |
| MTE1S0312MC | 3.3 | 12 | 83 | 348 | 6.5 | 8 | 15 | 83 | 86 | 20 | |
| MTE1S0315MC | 3.3 | 15 | 66 | 346 | 6 | 8 | 13 | 83 | 86 | 20 | |
| MTE1S0503MC | 5 | 3.3 | 303 | 248 | 9 | 12 | 24 | 77 | 79 | 21 | |
| MTE1S0505MC | 5 | 5 | 200 | 239 | 6.5 | 8 | 20 | 79 | 82 | 22 | |
| MTE1S0506MC | 5 | 6 | TBC | 236 | 6 | 7.5 | 20 | 81 | 83 | 24 | |
| MTE1S0509MC | 5 | 9 | 111 | 233 | 5 | 6.5 | 15 | 83 | 85 | 26 | |
| MTE1S0512MC | 5 | 12 | 83 | 227 | 5 | 6.5 | 14 | 84 | 87 | 29 | |
| MTE1S0515MC | 5 | 15 | 66 | 225 | 5 | 6.5 | 11 | 85 | 88 | 33 | |
| MTE1S1205MC | 12 | 5 | 200 | 97 | 5 | 7 | 19 | 81 | 84 | 34 | |
| MTE1S1209MC | 12 | 9 | 111 | 95 | 3 | 4.5 | 13 | 82 | 86 | 39 | |
| MTE1S1212MC | 12 | 12 | 83 | 93 | 3 | 4.5 | 12 | 85 | 88 | 43 | |
| MTE1S1215MC | 12 | 15 | 66 | 93 | 3 | 4 | 11 | 85 | 88 | 40 | |
| MTE1S1505MC | 15 | 5 | 200 | 79 | 4 | 5.5 | 15 | 80 | 83 | 25 | |
| MTE1S1509MC | 15 | 9 | 111 | 77 | 3 | 4 | 9 | 81 | 86 | 38 | |
| MTE1S1512MC | 15 | 12 | 83 | 76 | 2.5 | 4 | 10 | 82 | 87 | 45 | |
| MTE1S1515MC | 15 | 15 | 66 | 75 | 2.5 | 4 | 8 | 84 | 88 | 57 | |
| MTE1S2405MC | 24 | 5 | 200 | 50 | 4 | 5.5 | 20 | 79 | 83 | 21 | |
| MTE1S2409MC | 24 | 9 | 111 | 48 | 2.5 | 4 | 19 | 84 | 86 | 31 | |
| MTE1S2412MC | 24 | 12 | 83 | 48 | 2 | 3.5 | 19 | 83 | 87 | 41 | |
| MTE1S2415MC | 24 | 15 | 66 | 48 | 2 | 3.5 | 22 | 85 | 88 | 48 | |

INPUT CHARACTERISTICS

| Parameter | Conditions | Min. | Typ. | Max. | Units |
|--------------------------|--|------|------|------|--------|
| Voltage range | Continuous operation, 3.3V input types | 2.97 | 3.3 | 3.63 | V |
| | Continuous operation, 5V input types | 4.5 | 5.0 | 5.5 | |
| | Continuous operation, 12V input types | 10.8 | 12.0 | 13.2 | |
| | Continuous operation, 15V input types | 13.5 | 15.0 | 16.5 | |
| | Continuous operation, 24V input types | 21.6 | 24 | 26.4 | |
| Reflected ripple current | | | 5 | 15 | mA p-p |

ISOLATION CHARACTERISTICS

| Parameter | Conditions | Min. | Typ. | Max. | Units |
|-------------------|---------------------------|------|------|------|-------|
| Isolation voltage | Flash tested for 1 second | 1000 | | | VDC |
| Resistance | Viso= 1000VDC | 20 | | | GΩ |

GENERAL CHARACTERISTICS

| Parameter | Conditions | Min. | Typ. | Max. | Units |
|---------------------|------------------|------|------|------|-------|
| Switching frequency | All output types | | 80 | | Hz |

ABSOLUTE MAXIMUM RATINGS

| | |
|---|-------|
| Lead temperature 1.5mm from case for 10 seconds | 300°C |
| Internal power dissipation | 600mW |
| Input voltage V _{IN} , MTE03 types | 5.5V |
| Input voltage V _{IN} , MTE05 types | 7V |
| Input voltage V _{IN} , MTE12 types | 15V |
| Input voltage V _{IN} , MTE15 types | 18V |
| Input voltage V _{IN} , MTE24 types | 28V |

1. If components are required in tape and reel format suffix order code with -R, e.g. MTE0505MC-R.

2. Calculated using MIL-HDBK-217 FN2 calculation model with nominal input voltage at full load.

All specifications typical at T_A=25°C, nominal input voltage and rated output current unless otherwise specified.



OUTPUT CHARACTERISTICS

| Parameter | Conditions | Min. | Typ. | Max. | Units |
|----------------------------|---|------|------|------|--------|
| Rated power | T _A =-40°C to 85°C | | | 1.0 | W |
| Voltage set point accuracy | See tolerance envelope | | | | |
| Line regulation | High V _{IN} to low V _{IN} | | 1.1 | 1.2 | %/% |
| Ripple and noise | BW=DC to 20MHz | | 25 | 70 | mV p-p |

TEMPERATURE CHARACTERISTICS

| Parameter | Conditions | Min. | Typ. | Max. | Units |
|-------------------------------------|---------------------|------|------|------|-------|
| Specification | All output types | -40 | | 85 | °C |
| Storage | | -50 | | 130 | |
| Case temperature rise above ambient | All output types | | 12.5 | 20 | |
| Cooling | Free air convection | | | | |

TECHNICAL NOTES

ISOLATION VOLTAGE

'Hi Pot Test', 'Flash Tested', 'Withstand Voltage', 'Proof Voltage', 'Dielectric Withstand Voltage' & 'Isolation Test Voltage' are all terms that relate to the same thing, a test voltage, applied for a specified time, across a component designed to provide electrical isolation, to verify the integrity of that isolation.

Murata Power Solutions MTE series of DC/DC converters are all 100% production tested at their stated isolation voltage. This is 1kVDC for 1 second.

A question commonly asked is, "What is the continuous voltage that can be applied across the part in normal operation?"

For a part holding no specific agency approvals, such as the MTE series, both input and output should normally be maintained within SELV limits i.e. less than 42.4V peak, or 60VDC. The isolation test voltage represents a measure of immunity to transient voltages and the part should never be used as an element of a safety isolation system. The part could be expected to function correctly with several hundred volts offset applied continuously across the isolation barrier; but then the circuitry on both sides of the barrier must be regarded as operating at an unsafe voltage and further isolation/insulation systems must form a barrier between these circuits and any user-accessible circuitry according to safety standard requirements.

REPEATED HIGH-VOLTAGE ISOLATION TESTING

It is well known that repeated high-voltage isolation testing of a barrier component can actually degrade isolation capability, to a lesser or greater degree depending on materials, construction and environment. The MTE series has toroidal isolation transformers, with no additional insulation between primary and secondary windings of enameled wire. While parts can be expected to withstand several times the stated test voltage, the isolation capability does depend on the wire insulation. Any material, including this enamel (typically polyurethane) is susceptible to eventual chemical degradation when subject to very high applied voltages thus implying that the number of tests should be strictly limited. We therefore strongly advise against repeated high voltage isolation testing, but if it is absolutely required, that the voltage be reduced by 20% from specified test voltage.

This consideration equally applies to agency recognized parts rated for better than functional isolation where the wire enamel insulation is always supplemented by a further insulation system of physical spacing or barriers.

TEMPERATURE DERATING GRAPH

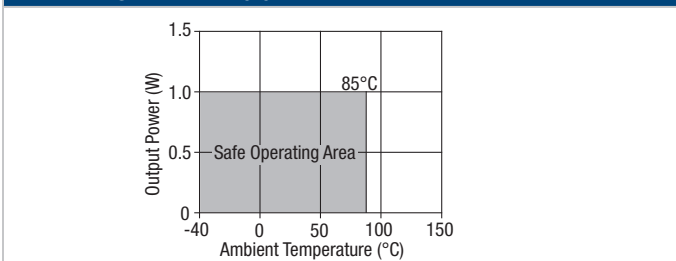

1. 12V input types have typically 3% less load regulation change.

TOLERANCE ENVELOPES

The voltage tolerance envelope shows typical load regulation characteristics for this product series. The tolerance envelope is the maximum output voltage variation due to changes in output loading.

0303, 0503

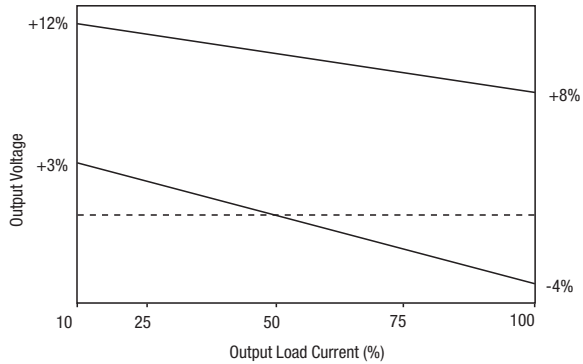

0305, 0309

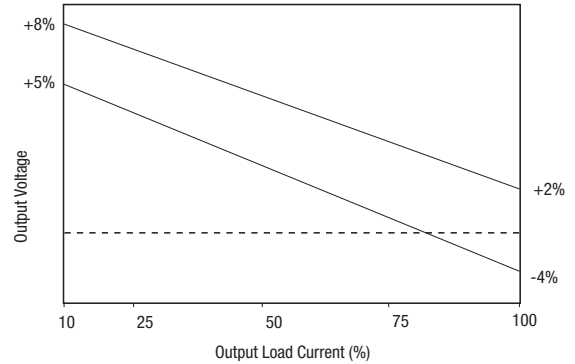

0312, 0315, 0505, 0506, 0509

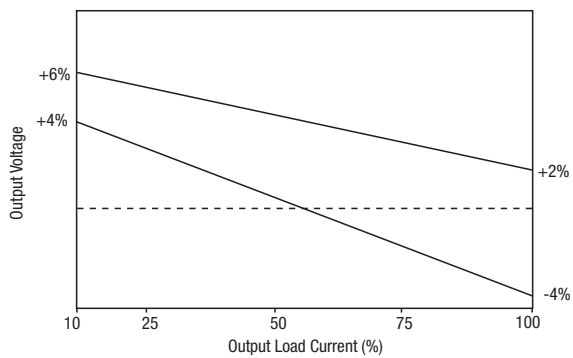

1209, 1212, 1505

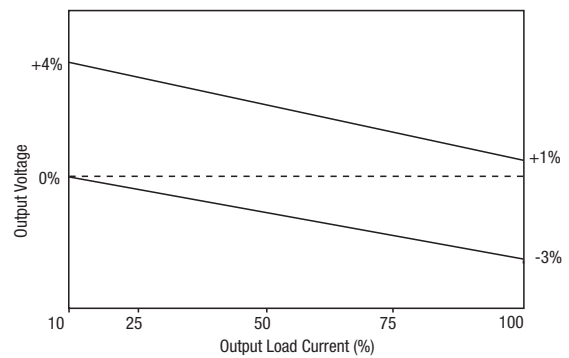

0512, 0515, 1205, 2405

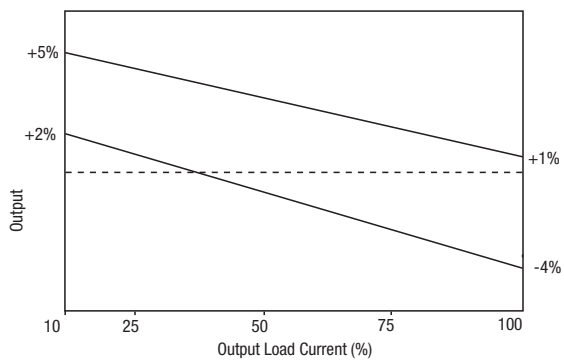

1215, 1509, 1512, 1515, 2409, 2412, 2415

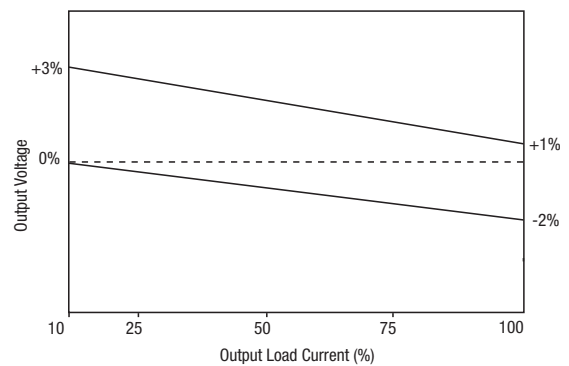

EFFICIENCY VS LOAD

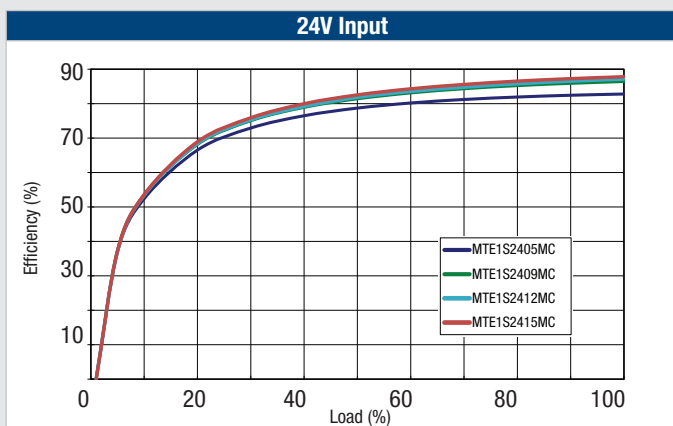
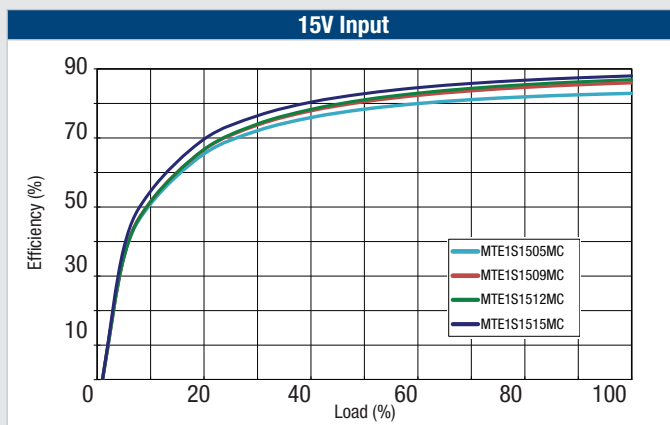
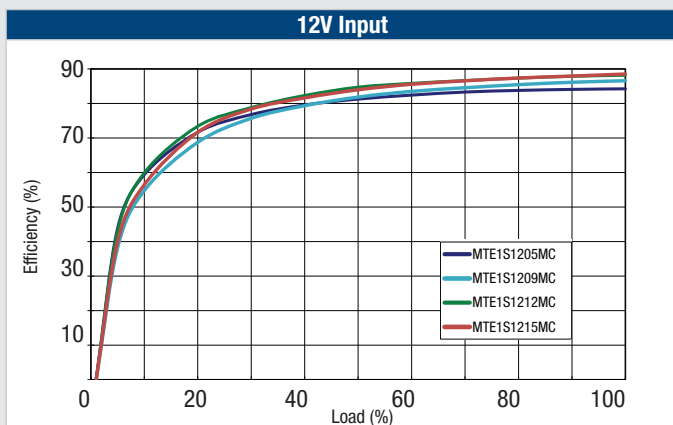

RoHS COMPLIANCE, MSL AND PSL INFORMATION



This series is compatible with RoHS soldering systems with a peak reflow solder temperature of 245°C as per J-STD-020D. The pin termination finish on this product series is Matte Tin over Nickel Preplate. The series is backward compatible with Sn/Pb soldering systems. The series has a Moisture Sensitivity Level (MSL) 1.

Samples of the product series were tested in accordance with the conditioning described for MSL level 1 in IPS/J-STD-020D. The product series passed electrical tests and visual inspection criteria.

For further information, please visit: www.murata-ps.com/rohs

APPLICATION NOTES

Minimum load

The minimum load to meet datasheet specification is 10% of the full rated load across the specified input voltage range. Lower than 10% minimum loading will result in an increase in output voltage, which may rise to typically double the specified output voltage if the output load falls to less than 5%.

Capacitive loading and start up

Typical start up times for this series, with a typical input voltage rise time of 2.2µs and output capacitance of 10µF, are shown in the table below. The product series will start into a capacitance of 47µF with an increased start time, however, the maximum recommended output capacitance is 10µF.

| | Start-up time µs | | Start-up time µs | | Start-up time µs |
|-------------|---------------------|-------------|---------------------|-------------|---------------------|
| MTE1S0303MC | | MTE1S0509MC | | MTE1S1509MC | |
| MTE1S0305MC | | MTE1S0512MC | | MTE1S1512MC | |
| MTE1S0309MC | | MTE1S0515MC | | MTE1S1515MC | |
| MTE1S0312MC | | MTE1S1205MC | | MTE1S2405MC | |
| MTE1S0315MC | | MTE1S1209MC | | MTE1S2409MC | |
| MTE1S0503MC | | MTE1S1212MC | | MTE1S2412MC | |
| MTE1S0505MC | | MTE1S1215MC | | MTE1S2415MC | |
| MTE1S0506MC | | MTE1S1505MC | | | |

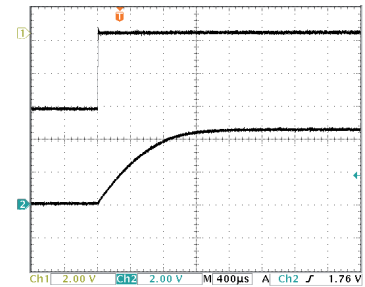

Output Ripple Reduction

By using the values of inductance and capacitance stated, the output ripple at the rated load is lowered to 5mV p-p max.

Component selection

Capacitor: It is required that the ESR (Equivalent Series Resistance) should be as low as possible, ceramic types are recommended. The voltage rating should be at least twice (except for 15V output), the rated output voltage of the DC/DC converter.

Inductor: The rated current of the inductor should not be less than that of the output of the DC/DC converter. At the rated current, the DC resistance of the inductor should be such that the voltage drop across the inductor is <2% of the rated voltage of the DC/DC converter. The SRF (Self Resonant Frequency) should be >20MHz.

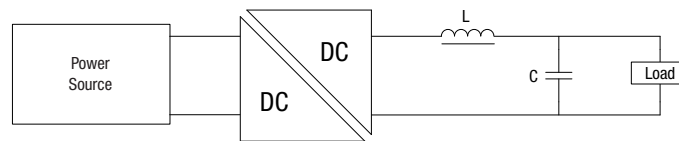

Typical Start-Up Wave Form

| | Inductor | | | Capacitor C, µF |
|-------------|----------|-----|--------------|--------------------|
| | L, µH | SMD | Through Hole | |
| MTE1S0303MC | | | | |
| MTE1S0305MC | | | | |
| MTE1S0309MC | | | | |
| MTE1S0312MC | | | | |
| MTE1S0315MC | | | | |
| MTE1S0503MC | | | | |
| MTE1S0505MC | | | | |
| MTE1S0506MC | | | | |
| MTE1S0509MC | | | | |
| MTE1S0512MC | | | | |
| MTE1S0515MC | | | | |
| MTE1S1205MC | | | | |

| | Inductor | | | Capacitor C, µF |
|-------------|----------|-----|--------------|--------------------|
| | L, µH | SMD | Through Hole | |
| MTE1S1209MC | | | | |
| MTE1S1212MC | | | | |
| MTE1S1215MC | | | | |
| MTE1S1505MC | | | | |
| MTE1S1509MC | | | | |
| MTE1S1512MC | | | | |
| MTE1S1515MC | | | | |
| MTE1S2405MC | | | | |
| MTE1S2409MC | | | | |
| MTE1S2412MC | | | | |
| MTE1S2415MC | | | | |

PACKAGE SPECIFICATIONS

MECHANICAL DIMENSIONS

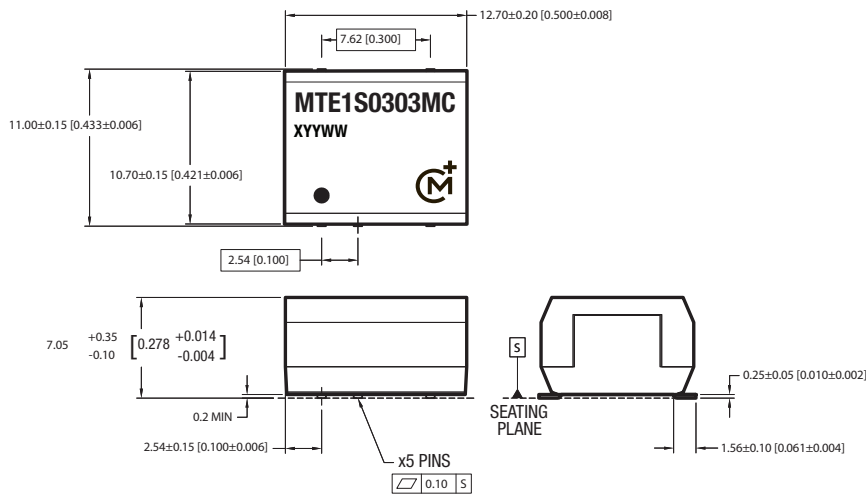

All dimensions in mm ±0.25mm (inches ±0.01). All pins on a 2.54 (0.1) pitch and within ± 0.25 (0.01) of true position.

Weight: 1.1g

PIN CONNECTIONS

| Pin | Function |
|-----|-------------------|
| 1 | -V _{IN} |
| 3 | +V _{IN} |
| 5 | NA |
| 7 | -V _{OUT} |
| 8 | +V _{OUT} |
| 10 | NA |
| 12 | NA |
| 14 | NA |

NA - Not available for electrical connection.

RECOMMENDED FOOTPRINT DETAILS

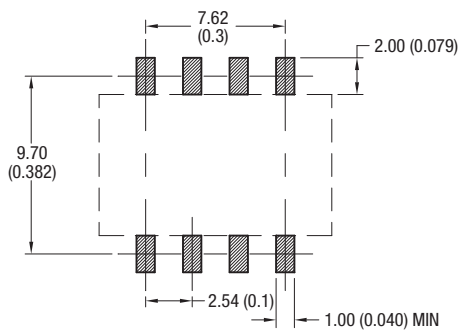

All pins on a 2.54mm pitch.
Unless otherwise stated all dimensions in mm (inches) ±0.5mm.

TUBE OUTLINE DIMENSIONS

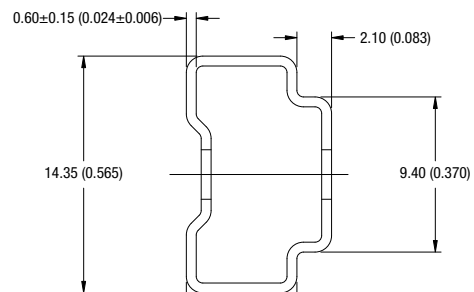

Unless otherwise stated all dimensions in mm (inches) ±0.02.
Tube length : 475±2.0 (18.70±0.07).

Tube Quantity : 35

TAPE & REEL SPECIFICATIONS

REEL OUTLINE DIMENSIONS



TAPE OUTLINE DIMENSIONS

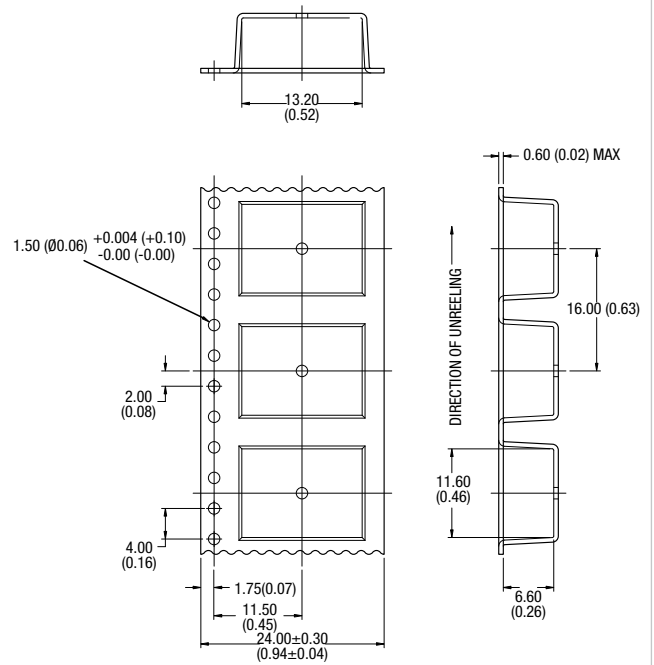

REEL PACKAGING DETAILS



Product Orientation
Pin 1, located nearest to carrier drive sprocket.

Reel Quantity : TBC

Murata Power Solutions, Inc.
11 Cabot Boulevard, Mansfield, MA 02048-1151 U.S.A.
ISO 9001 and 14001 REGISTERED

Murata Power Solutions, Inc. makes no representation that the use of its products in the circuits described herein, or the use of other technical information contained herein, will not infringe upon existing or future patent rights. The descriptions contained herein do not imply the granting of licenses to make, use, or sell equipment constructed in accordance therewith. Specifications are subject to change without notice. © 2012 Murata Power Solutions, Inc.



Компания «ЭлектроПласт» предлагает заключение долгосрочных отношений при поставках импортных электронных компонентов на взаимовыгодных условиях!

Наши преимущества:

- Оперативные поставки широкого спектра электронных компонентов отечественного и импортного производства напрямую от производителей и с крупнейших мировых складов;
- Поставка более 17-ти миллионов наименований электронных компонентов;
- Поставка сложных, дефицитных, либо снятых с производства позиций;
- Оперативные сроки поставки под заказ (от 5 рабочих дней);
- Экспресс доставка в любую точку России;
- Техническая поддержка проекта, помощь в подборе аналогов, поставка прототипов;
- Система менеджмента качества сертифицирована по Международному стандарту ISO 9001;
- Лицензия ФСБ на осуществление работ с использованием сведений, составляющих государственную тайну;
- Поставка специализированных компонентов (Xilinx, Altera, Analog Devices, Intersil, Interpoint, Microsemi, Aeroflex, Peregrine, Syfer, Eurofarad, Texas Instrument, Miteq, Cobham, E2V, MA-COM, Hittite, Mini-Circuits, General Dynamics и др.);

Помимо этого, одним из направлений компании «ЭлектроПласт» является направление «Источники питания». Мы предлагаем Вам помощь Конструкторского отдела:

- Подбор оптимального решения, техническое обоснование при выборе компонента;
- Подбор аналогов;
- Консультации по применению компонента;
- Поставка образцов и прототипов;
- Техническая поддержка проекта;
- Защита от снятия компонента с производства.



Как с нами связаться

Телефон: 8 (812) 309 58 32 (многоканальный)

Факс: 8 (812) 320-02-42

Электронная почта: org@eplast1.ru

Адрес: 198099, г. Санкт-Петербург, ул. Калинина, дом 2, корпус 4, литера А.