

Safety Light Curtains

F3SJ-A



Rev. 2.12

Safety Light Curtains

- Resolution: 14 mm (0.55 in.), 20 mm (0.79 in.), 25 mm (1.01 in.), 30 mm (1.18 in.), or 55 mm (2.17 in.)
- Range: 7 m (23 ft.) or 9 m (29.5 ft.) dependent on minimum object resolution and protected height
- Protected heights: 14 mm protected heights from 245 to 1631 mm (9.6 to 64 in.), 20 mm, 25 mm and 30 mm protected heights from 245 to 2495 mm (9.6 to 98 in.), 55 mm from 270 to 2470 mm (10.6 to 97 in.)
- Very compact size – 30 x 24 mm (1.18 x 0.94 in.)
- Cascaded designs possible – 4 segments, up to 400 beams
- Partial muting and position detection muting
- Cross-talk prevention

D

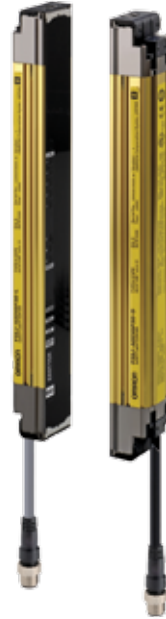

Description

Position Detection Muting Function

Position Detection Muting Function is used in applications where the workpiece is set in position each time by an operator, and a turntable or positioning robot then moves the workpiece to the area where the work is performed. A limit switch or other means is used to detect when the robot is in a safe position and muting is then applied.



Warning Zone Function

With the F3SJ-A, part of the detection zone can be used as warning zone to generate an alarm when someone approaches the danger zone. If the person then enters the danger zone the F3SJ-A will send a stop signal to the guarded machine. In addition, the auxiliary output can be used to activate a flashing lamp to alert the person in the warning zone.

The detection zone for a single F3SJ-A can be divided into two zones or set a single warning zone for multiple, cascaded F3SJ-A units.

Dividing the zone between series-connected sensors

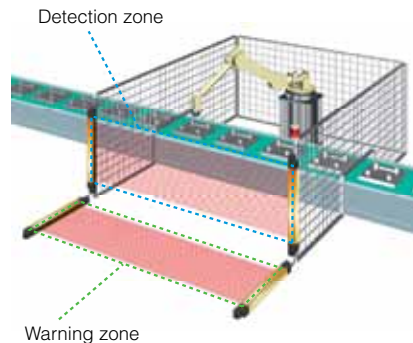

Partial Muting Function

Muting temporarily disables the F3SJ-A when an object must pass through the detection zone, such as when supplying a workpiece to your equipment.

Partial muting increases the level of safety by only muting the beams of the safety light curtain where the workpiece passes through, while preventing muting in all other areas.

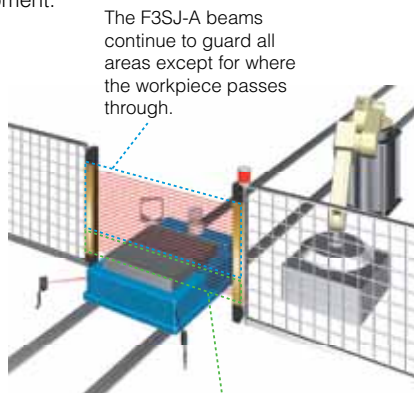

The F3SJ-A beams continue to guard all areas except for where the workpiece passes through.

Only the beams of the safety light curtain interrupted by the workpiece are muted.

SD Manager Software

Using the SD Manager software, all features of the F3SJ-A can be set and checked. Features include:

- Display of system specifications:
 - Model
 - Number of beams
 - Minimum object resolution
 - Response time
- Settings for:
 - Fixed blanking
 - Floating blanking
 - Warning zone configuration
 - Muting – Both partial and position detection
 - External indicator function
 - Auxiliary outputs
 - EDM parameters
 - Operating range
- Monitoring of received and ambient light intensity
- Maintenance information:
 - Power on time
 - OSSD switching frequency
- Recovery of settings
- Safety distance calculations based on parameters for connected system

Setting Console

When you don't want to take a computer into the field with you the F39-MC21 setting console is a convenient way to set parameters and check the system status.

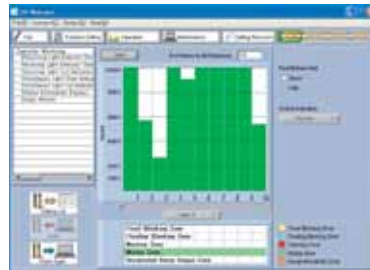
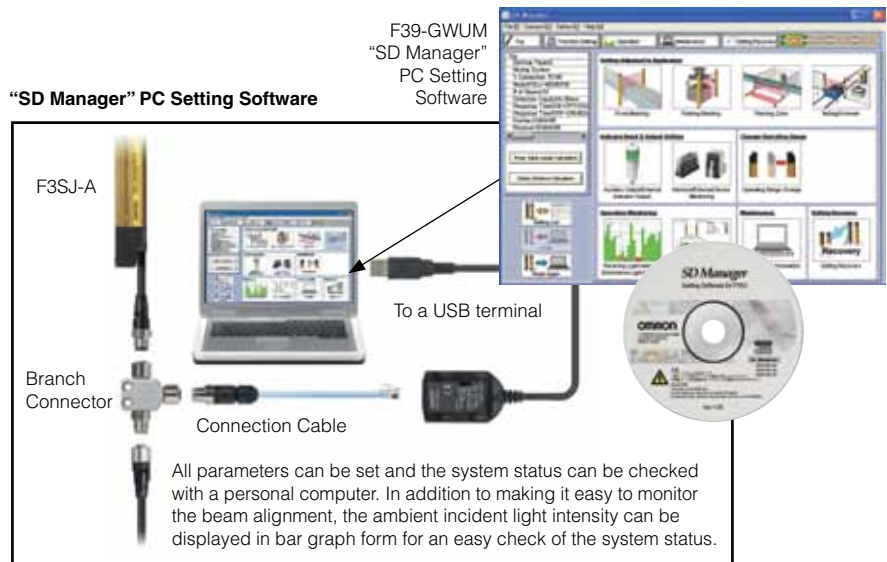

Beam Alignment is Easier

The incident light level can be displayed in a bar graph for each beam.

Applications

With built-in muting and blanking functions, the F3SJ-A can be employed in a wide variety of applications from robotic work cells to small machines. The potential for cascaded design and a broad selection of minimum object resolutions adds to this versatility.

Selecting the Best Configuration

Space Efficient and Low Cost

The built-in external device monitoring function eliminates the need for a safety relay unit.

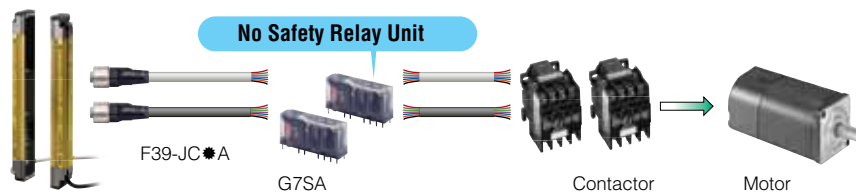

Reduced Wiring and Easy Maintenance

Cables with connectors on both ends simplify connections and prevent wiring errors.



Specifications

| | |
|---|--|
| Performance | |
| Resolution: | 14 mm, 20 mm, 25 mm, 30 mm, 55 mm |
| Protected Height: | 14 mm – 245 to 1631 mm (9.6 to 64.2 in.) 20 mm, 25 mm and 30 mm – 245 to 2495 mm (9.6 to 98.2 in.) 55 mm – 270 to 2470 mm (10.6 to 97.2 in.) |
| Operating Range: | 0.2 to 9 m for all protective heights up to 1640 mm (64.6 in.) 0.2 to 7 m for all protective heights longer than 1640 mm (64.6 in.): |
| Effective Aperture Angle: | ±2.5° maximum, transmitter and receiver at operating range greater than 3 m (9.8 ft.) |
| Response Time: | For 14 mm resolution systems up to 983 mm (38.7 in.) protected height ≤17.5 ms For 14 mm resolution systems above 983 mm (38.7 in.) protected height ≤25 ms For 20 mm resolution systems up to 1205 mm (47.4 in.) protected height ≤15 ms For 20 mm resolution systems above 1205 mm (47.4 in.) protected height ≤22.5ms For 25 mm resolution systems up to 1600 mm (63.0 in.) protected height ≤15 ms For 25 mm resolution systems above 1600 mm (63.0 in.) protected height ≤20.0ms For 30 mm resolution systems, all protected heights ≤17.5 ms For 55 mm resolution systems, all protected heights ≤13 ms |
| Safety Output Rating: | Two 24 VDC PNP outputs sourcing 300 mA max. |
| Auxiliary (Non-Safety) Output Ratings: | One 24 VDC PNP output sourcing 300 mA max. |
| Light Source: | Infrared LED, 870 nm |
| Indicators: | Transmitter: 5 LED Light Level Indicators, 3 LED Error Indicators, Power, Interlock, EDM, Blanking/Test Receiver: 5 LED Light Level Indicators, 3 LED Error Indicators, Machine Run, Machine Stop |
| Mechanical | |
| Enclosure: | Anodized aluminum housing |
| Cable Length: | Optional cables are available up to 20 m (65.6 ft.) in length |
| Transmitter and Receiver Cable Connections: | M12, 8-pin |
| Electrical | |
| Power Supply: | 24 VDC ± 20% |
| Environmental | |
| Protection Rating: | IP65 |
| Operating Temperature: | -10 to 55°C (14 to 131°F) |
| Storage Temperature: | -30 to 70°C (-22 to 158°F) |
| Relative Humidity: | 35 to 85% non-condensing |
| Vibration: | 10 to 55 Hz, double amplitude of 0.7 mm, 20 sweeps in X, Y, and Z directions |
| Shock: | 100 m/s ² , 1000 times each in X, Y and Z directions |
| Approvals | ESPE Type 4 (IEC 61496-1/-2) Category 4 / PL e (EN ISO 13849-1) SIL3 / SIL3 CL3 (IEC 61508)UL508, UL1998, CAN/CSA-C22.2 No. 14, CAN/CSA-C22.2 No. 0.8 |

Specifications are subject to change without notice.

F3SP-B1P Control Unit

| | |
|------------------------|--|
| Power Supply Voltage: | 24 VDC ±10% |
| Power Consumption: | DC1.7 W max (not including sensor's current consumption) |
| Operation Time: | 100 ms max. (not including the sensor's response time) |
| Response Time: | 10 ms max. (not including the sensor's response time) |
| Relay Output | |
| Number of Contacts: | 3 N.O., 1 N.C. |
| Rated Load: | 250 VAC 5 A (cos = 1); 30 VDC 5 A L/R = 0 ms |
| Rated Current: | 5 A |
| Connection Type | |
| Between Sensors: | M12 connector (8-pin) |
| Others: | Terminal block |
| Weight: | Approx. 280 g (9.9 oz.) |

Specifications are subject to change without notice.

D

Wiring

Wiring for Single F3SJ-A Application

Detection of a welded relay contact is possible without a controller relay unit.

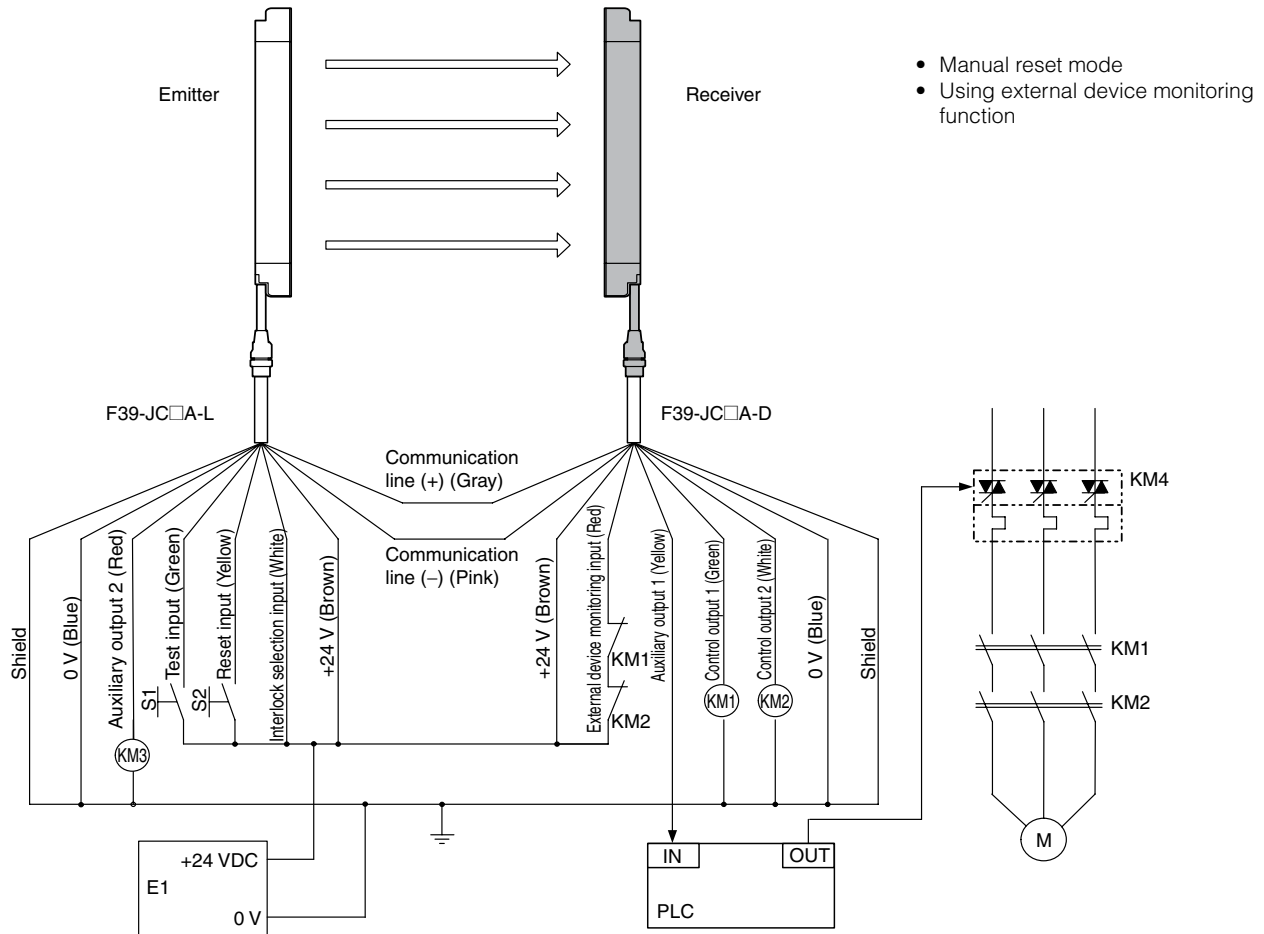

D

Dimensions

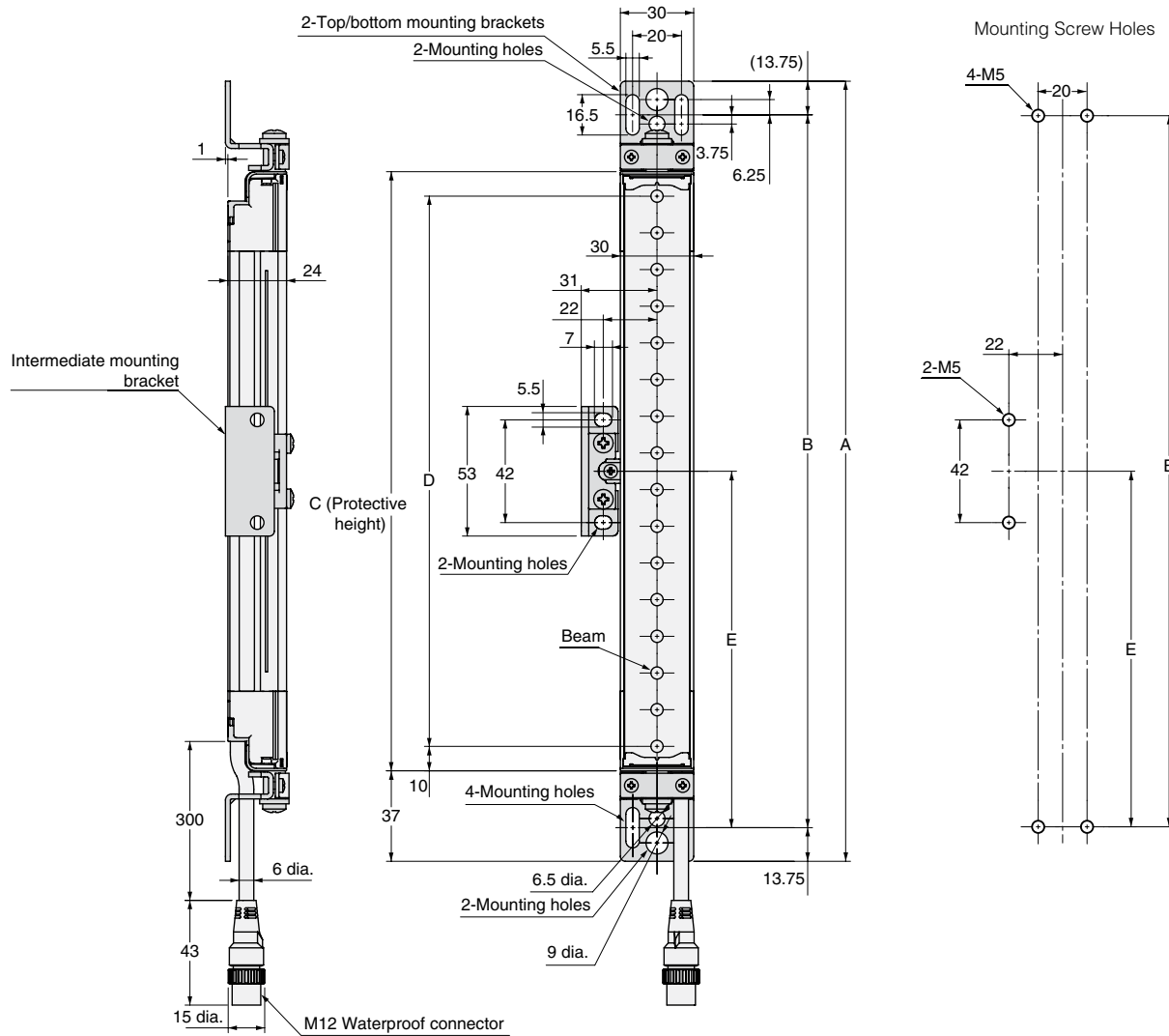

How to Calculate Your System Dimensions:

C (protective height) = 4-digit number in the table

A = C + 74

B = C + 46.5

D = C - 20

E = see chart below

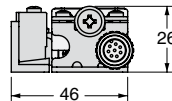

| Protective Height | Number of Intermediate Brackets | E* |
|------------------------------------|---------------------------------|---------|
| 245 to 596 mm (9.6 to 23.5 in.) | 0 | — |
| 600 to 1130 mm (23.6 to 44.5 in.) | 1 | E = B/2 |
| 1136 to 1658 mm (44.7 to 65.3 in.) | 2 | E = B/3 |
| 1660 to 2180 mm (65.4 to 85.8 in.) | 3 | E = B/4 |
| 2195 to 2500 mm (86.4 to 98.4 in.) | 4 | E = B/5 |

*Use E = 530 or less when none of the E values shown above are used.

Ordering

The minimum components required for an F3SJ-A system are an emitter receiver set and a set of single or double-ended connector cables. See the table below for an overview of the versions available. The pages which follow provide specific part numbers and accessory descriptions.

Safety Light Curtain F3SJ-A

| Designator | Protection | Detection | Beam Gap | Operating Range | No. of Beams | Protective Height |
|-------------------------------|-------------|-----------|----------|------------------------------|--------------|------------------------------------|
| F3SJ-A□□□□P14 ¹ | Finger | 14 mm | 9 mm | 0.2 to 9 m (0.7 to 29.5 ft.) | 26 to 197 | 245 to 1784 mm (9.6 to 70.2 in.) |
| F3SJ-A□□□□P20 ¹ | Finger/Hand | 20 mm | 15 mm | 0.2 to 9 m (0.7 to 29.5 ft.) | 16 to 100 | 245 to 1505 mm (9.6 to 59.3 in.) |
| F3SJ-A□□□□P20 ¹ | Finger/Hand | 20 mm | 15 mm | 0.2 to 7 m (0.7 to 23.0 ft.) | 110 to 166 | 1655 to 2495 mm (65.2 to 98.2 in.) |
| F3SJ-A□□□□P20-TS ² | Finger/Hand | 20 mm | 15 mm | 0.2 to 9 m (0.7 to 29.5 ft.) | 16 to 100 | 245 to 1505 mm (9.6 to 59.3 in.) |
| F3SJ-A□□□□P20-TS ² | Finger/Hand | 20 mm | 15 mm | 0.2 to 7 m (0.7 to 23.0 ft.) | 110 to 166 | 1655 to 2495 mm (65.2 to 98.2 in.) |
| F3SJ-A□□□□P25 ¹ | Hand | 25 mm | 20 mm | 0.2 to 9 m (0.7 to 29.5 ft.) | 13 to 79 | 260 to 1580 mm (10.2 to 62.2 in.) |
| F3SJ-A□□□□P25 ¹ | Hand | 25 mm | 20 mm | 0.2 to 7 m (0.7 to 23.0 ft.) | 87 to 125 | 1740 to 2500 mm (68.5 to 98.4 in.) |
| F3SJ-A□□□□P25-TS ² | Hand | 25 mm | 20 mm | 0.2 to 9 m (0.7 to 29.5 ft.) | 13 to 79 | 260 to 1580 mm (10.2 to 62.2 in.) |
| F3SJ-A□□□□P25-TS ² | Hand | 25 mm | 20 mm | 0.2 to 7 m (0.7 to 23.0 ft.) | 87 to 125 | 1740 to 2500 mm (68.5 to 98.4 in.) |
| F3SJ-A□□□□P30 ¹ | Hand/arm | 30 mm | 25 mm | 0.2 to 9 m (0.7 to 29.5 ft.) | 10 to 65 | 245 to 1620 mm (9.6 to 63.8 in.) |
| F3SJ-A□□□□P30 ¹ | Hand/arm | 30 mm | 25 mm | 0.2 to 7 m (0.7 to 23.0 ft.) | 70 to 100 | 1745 to 2495 mm (68.7 to 98.2 in.) |
| F3SJ-A□□□□P55 ¹ | Leg/body | 55 mm | 50 mm | 0.2 to 9 m (0.7 to 29.5 ft.) | 6 to 33 | 270 to 1620 mm (10.6 to 63.8 in.) |
| F3SJ-A□□□□P55 ¹ | Leg/body | 55 mm | 50 mm | 0.2 to 7 m (0.7 to 23.0 ft.) | 36 to 50 | 1770 to 2470 mm (69.7 to 97.2 in.) |

Notes: Connection cables are not included with the products and must be purchased separately as needed.

Specific Model Numbers

| Model | No. of Beams | Protective Height (mm) | Model | No. of Beams | Protective Height (mm) | Model | No. of Beams | Protective Height (mm) | Model | No. of Beams | Protective Height (mm) |
|--------------------------------------|--------------|------------------------|--------------------------------------|--------------|------------------------|------------------------|--------------|------------------------|------------------------|--------------|------------------------|
| F3SJ-A14 Series | | | F3SJ-A0635P20 | 42 | 635 | F3SJ-A1180P25 | 59 | 1180 | F3SJ-A1195P30 | 48 | 1195 |
| F3SJ-A0245P14 | 26 | 245 | F3SJ-A0665P20 | 44 | 665 | F3SJ-A1260P25 | 63 | 1260 | F3SJ-A1220P30 | 49 | 1220 |
| F3SJ-A0263P14 | 28 | 263 | F3SJ-A0695P20 | 46 | 695 | F3SJ-A1420P25 | 71 | 1420 | F3SJ-A1270P30 | 51 | 1270 |
| F3SJ-A0299P14 | 32 | 299 | F3SJ-A0755P20 | 50 | 755 | F3SJ-A1500P25 | 75 | 1500 | F3SJ-A1395P30 | 56 | 1395 |
| F3SJ-A0317P14 | 34 | 317 | F3SJ-A0785P20 | 52 | 785 | F3SJ-A1580P25 | 79 | 1580 | F3SJ-A1495P30 | 60 | 1495 |
| F3SJ-A0389P14 | 42 | 389 | F3SJ-A0815P20 | 54 | 815 | F3SJ-A1740P25 | 87 | 1740 | F3SJ-A1620P30 | 65 | 1620 |
| F3SJ-A0425P14 | 46 | 425 | F3SJ-A0875P20 | 58 | 875 | F3SJ-A1900P25 | 95 | 1900 | F3SJ-A1745P30 | 70 | 1745 |
| F3SJ-A0461P14 | 50 | 461 | F3SJ-A0905P20 | 60 | 905 | F3SJ-A2060P25 | 103 | 2060 | F3SJ-A1820P30 | 73 | 1820 |
| F3SJ-A0533P14 | 58 | 533 | F3SJ-A0935P20 | 62 | 935 | F3SJ-A2220P25 | 111 | 2220 | F3SJ-A1870P30 | 75 | 1870 |
| F3SJ-A0551P14 | 60 | 551 | F3SJ-A0965P20 | 64 | 965 | F3SJ-A2380P25 | 119 | 2380 | F3SJ-A1995P30 | 80 | 1995 |
| F3SJ-A0605P14 | 66 | 605 | F3SJ-A1025P20 | 68 | 1025 | F3SJ-A2420P25 | 121 | 2420 | F3SJ-A2245P30 | 90 | 2245 |
| F3SJ-A0623P14 | 68 | 623 | F3SJ-A1115P20 | 74 | 1115 | F3SJ-A2500P25 | 125 | 2500 | F3SJ-A2370P30 | 95 | 2370 |
| F3SJ-A0695P14 | 76 | 695 | F3SJ-A1205P20 | 80 | 1205 | F3SJ-A30 Series | | | F3SJ-A2495P30 | 100 | 2495 |
| F3SJ-A0731P14 | 80 | 731 | F3SJ-A1265P20 | 84 | 1265 | F3SJ-A0245P30 | 10 | 245 | F3SJ-A55 Series | | |
| F3SJ-A0767P14 | 84 | 767 | F3SJ-A1445P20 | 96 | 1445 | F3SJ-A0295P30 | 12 | 295 | F3SJ-A0270P55 | 6 | 270 |
| F3SJ-A0803P14 | 88 | 803 | F3SJ-A1505P20 | 100 | 1505 | F3SJ-A0320P30 | 13 | 320 | F3SJ-A0320P55 | 7 | 320 |
| F3SJ-A0875P14 | 96 | 875 | F3SJ-A1655P20 | 110 | 1655 | F3SJ-A0395P30 | 16 | 395 | F3SJ-A0370P55 | 8 | 370 |
| F3SJ-A0911P14 | 100 | 911 | F3SJ-A1805P20 | 120 | 1805 | F3SJ-A0470P30 | 19 | 470 | F3SJ-A0420P55 | 9 | 420 |
| F3SJ-A0983P14 | 108 | 983 | F3SJ-A1955P20 | 130 | 1955 | F3SJ-A0520P30 | 21 | 520 | F3SJ-A0470P55 | 10 | 470 |
| F3SJ-A1055P14 | 116 | 1055 | F3SJ-A2105P20 | 140 | 2105 | F3SJ-A0545P30 | 22 | 545 | F3SJ-A0570P55 | 12 | 570 |
| F3SJ-A1127P14 | 124 | 1127 | F3SJ-A2255P20 | 150 | 2255 | F3SJ-A0570P30 | 23 | 570 | F3SJ-A0620P55 | 13 | 620 |
| F3SJ-A1199P14 | 132 | 1199 | F3SJ-A2405P20 | 160 | 2405 | F3SJ-A0620P30 | 25 | 620 | F3SJ-A0720P55 | 15 | 720 |
| F3SJ-A1271P14 | 140 | 1271 | F3SJ-A2495P20 | 166 | 2495 | F3SJ-A0695P30 | 28 | 695 | F3SJ-A0770P55 | 16 | 770 |
| F3SJ-A1487P14 | 164 | 1487 | F3SJ-A25, F3SJ-A25-TS* Series | | | F3SJ-A0720P30 | 29 | 720 | F3SJ-A0870P55 | 18 | 870 |
| F3SJ-A1631P14 | 180 | 1631 | F3SJ-A0260P25 | 13 | 260 | F3SJ-A0770P30 | 31 | 770 | F3SJ-A0920P55 | 19 | 920 |
| F3SJ-A1784P14 | 197 | 1784 | F3SJ-A0300P25 | 15 | 300 | F3SJ-A0795P30 | 32 | 795 | F3SJ-A0970P55 | 20 | 970 |
| F3SJ-A20, F3SJ-A20-TS* Series | | | F3SJ-A0460P25 | 23 | 460 | F3SJ-A0820P30 | 33 | 820 | F3SJ-A1020P55 | 21 | 1020 |
| F3SJ-A0245P20 | 16 | 245 | F3SJ-A0540P25 | 27 | 540 | F3SJ-A0870P30 | 35 | 870 | F3SJ-A1120P55 | 23 | 1120 |
| F3SJ-A0275P20 | 18 | 275 | F3SJ-A0620P25 | 31 | 620 | F3SJ-A0920P30 | 37 | 920 | F3SJ-A1170P55 | 24 | 1170 |
| F3SJ-A0305P20 | 20 | 305 | F3SJ-A0700P25 | 35 | 700 | F3SJ-A0945P30 | 38 | 945 | F3SJ-A1220P55 | 25 | 1220 |
| F3SJ-A0395P20 | 26 | 395 | F3SJ-A0780P25 | 39 | 780 | F3SJ-A0995P30 | 40 | 995 | F3SJ-A1270P55 | 26 | 1270 |
| F3SJ-A0455P20 | 30 | 455 | F3SJ-A0860P25 | 43 | 860 | F3SJ-A1020P30 | 41 | 1020 | F3SJ-A1320P55 | 27 | 1320 |
| F3SJ-A0545P20 | 36 | 545 | F3SJ-A0940P25 | 47 | 940 | F3SJ-A1045P30 | 42 | 1045 | F3SJ-A1420P55 | 29 | 1420 |
| F3SJ-A0575P20 | 38 | 575 | F3SJ-A1020P25 | 51 | 1020 | F3SJ-A1095P30 | 44 | 1095 | F3SJ-A1570P55 | 32 | 1570 |
| F3SJ-A0605P20 | 40 | 605 | F3SJ-A1100P25 | 55 | 1100 | F3SJ-A1120P30 | 45 | 1120 | | | |

(Continued on next page)

Notes: Connection cables are not included with the products and must be purchased separately as needed.

* The suffix "-TS" is attached to the model number of models with fixed auto reset.

¹ Models with S-mark certification have an "S" at the end of the model number. S-mark certification is for equipment sold in South Korea. Example: F3SJ-A0245P14-S.

² Models with fixed auto reset (-TS). Parameters cannot be set using the F39-MC21 Setting Console or F39-GWUM "SD Manager" Support Software for F3SJ-A.

 = Highlighted **Rapid Delivery** products are available for shipment today or within **THREE** days.

Ordering (continued)

| Model | No. of Beams | Protective Height (mm) |
|---------------|--------------|------------------------|
| F3SJ-A1620P55 | 33 | 1620 |
| F3SJ-A1770P55 | 36 | 1770 |
| F3SJ-A1920P55 | 39 | 1920 |
| F3SJ-A2070P55 | 42 | 2070 |
| F3SJ-A2220P55 | 45 | 2220 |
| F3SJ-A2370P55 | 48 | 2370 |
| F3SJ-A2470P55 | 50 | 2470 |

 For information on Resource Modules, see page D59.

 For information on safety light curtain accessories, see page D74.

Accessories

D

| Model | Description |
|---|---|
| Single-End Connector Cable (2 cables per set, for emitter and receiver) For wiring with safety circuit such as single safety relay, safety relay unit, and safety controller | |
| F39-JC3A | M12 connector (8-pin), 3 m (9.8 ft.) |
| F39-JC7A | M12 connector (8-pin), 7 m (23.0 ft.) |
| F39-JC10A | M12 connector (8-pin), 10 m (32.8 ft.) |
| F39-JC15A | M12 connector (8-pin), 15 m (49.2 ft.) |
| F39-JC20A | M12 connector (8-pin), 20 m (65.6 ft.) |
| Double-End Connector Cable (2 cables per set, for emitter and receiver) For connection with F3SP-B1P control unit, and for extension when series-connected. Note: To extend the cable length under series connection, use F39-JJR3W and F39-JC□B in combination. | |
| F39-JCR5B | M12 connector (8-pin), 0.5 m (1.6 ft.) |
| F39-JC1B | M12 connector (8-pin), 1 m (3.3 ft.) |
| F39-JC3B | M12 connector (8-pin), 3 m (9.8 ft.) |
| F39-JC5B | M12 connector (8-pin), 5 m (16.4 ft.) |
| F39-JC7B | M12 connector (8-pin), 7 m (23.0 ft.) |
| F39-JC10B | M12 connector (8-pin), 10 m (32.8 ft.) |
| F39-JC15B | M12 connector (8-pin), 15 m (49.2 ft.) |
| F39-JC20B | M12 connector (8-pin), 20 m (65.6 ft.) |
| Series Connection Cable (2 cables per set, for emitter and receiver) | |
| F39-JJR3W | Series connection cable ³ or when using water-resistant case ⁴ , 0.3 m (1.0 ft.) |
| F39-JC□B | Extension cable, 0.5 to 15 m (1.6 to 49.2 ft.) To change series connection length in combination with F39-JJR3W |
| F39-JJR06L | Side-by-side series connection cable, 0.06 m (2.4 in.) Dedicated series connection cable with minimum length, used in place of the sensor's cable with connector |
| F39-JJR15L | Side-by-side series connection cable, 0.15 m (5.9 in.) Dedicated series connection cable with minimum length, used in place of the sensor's cable with connector |
| Sensor Mounting Brackets (spare parts) | |
| F39-LJ1 | Standard mounting bracket (for top/bottom), included with F3SJ system, 2 for emitter and 2 for receiver (total of 4 per set) |
| F39-LJ2 | Flat side mounting bracket, Use these small-sized brackets when performing side mounting with standard mounting brackets so that they do not protrude from the detection surface, 2 for emitter and 2 for receiver (total of 4 per set) |
| F39-LJ3 | Free-location mounting bracket (also used as standard intermediate bracket), Use these brackets for mounting any place without using standard bracket, 1 set with 2 pieces |
| Key Cap for Muting | |
| F39-CN6 | Cap attaches to the main unit to enable muting function, attach to either an emitter or a receiver, orange case |
| Setting Tools⁵ | |
| F39-GWUM | SD Manager Software Accessories: SD Manager CD-ROM, F39-CN1 Branch Connector, Connector Cap, 2 m Dedicated Cable, 0.3 m Dedicated Cable with Plug, Instruction Manual |
| F39-MC21 | Setting Console Accessories: F39-CN1 Branch Connector, Connector Cap, 2 m Dedicated Cable, 0.3 m Dedicated Cable with Plug, Instruction Manual |
| F39-JC2M | Spare cable for F39-GWUM and F39-MC21 |



F39-JC7A



F39-JC15B



F39-JJR3W



F39-JJR06L
F39-JJR15L



F39-LJ1



F39-LJ2



F39-LJ3



F39-CN6

³ Total cable length of series connection is 0.6 m to connect to connector cable of the main sensor unit. For series connection with minimum length, use the F39-JJR06L or F39-JJR15L.

⁴ When using the F39-EJ□□□□-L/D water-resistant case in series connection configurations, use the special series connection cables for the water-resistant case.

(Continued on next page)

 = Highlighted **Rapid Delivery** products are available for shipment today or within **THREE** days.

Ordering (continued)

Accessories (continued)

| Model | Description |
|---|--|
| Setting Tools⁵ | |
| F39-GWUM | SD Manager Software Accessories: SD Manager CD-ROM, F39-CN1 Branch Connector, Connector Cap, 2 m Dedicated Cable, 0.3 m Dedicated Cable with Plug, Instruction Manual |
| F39-MC21 | Setting Console Accessories: F39-CN1 Branch Connector, Connector Cap, 2 m Dedicated Cable, 0.3 m Dedicated Cable with Plug, Instruction Manual |
| F39-JC2M | Spare cable for F39-GWUM and F39-MC21 |
| Control Unit | |
| F3SP-B1P | Relay, 3 N.O. + 1 N.C. output, for connection with F3SJ-A, use an F39-JC□B double-end connector cable |
| Force-Guided Relays | |
| G7SA-2A2B | 4 contacts, 2 N.O. + 2 N.C., Rated switch load: 250 VAC 6 A, 30 VDC 6 A |
| G7SA-3A1B | 4 contacts, 3 N.O. + 1 N.C., Rated switch load: 250 VAC 6 A, 30 VDC 6 A |
| G7S-4A2B-E | 6 contacts, 4 N.O. + 2 N.C., Rated switch load: 250 VAC 10 A, 30 VDC 10 A |
| G7S-3A3B-E | 6 contacts, 3 N.O. + 3 N.O., Rated switch load: 250 VAC 10 A, 30 VDC 10 A |
| Dedicated External Indicator Set (Can be connected to either an emitter or a receiver) | |
| F39-A01PR-PAC | Indicator (red), mounting bracket (1 set), and dedicated connection cable (0.1 m) |
| F39-A01PG-PAC | Indicator (green), mounting bracket (1 set), and dedicated connection cable (0.1 m) |
| F39-A01PY-PAC | Indicator (yellow), mounting bracket (1 set), and dedicated connection cable (0.1 m) |
| General External Indicator Cable | |
| F39-JJ3N | Cable to connect top of the main unit and an off-the-shelf external indicator (2-wire), 3 m (9.8 ft.) |
| Spatter Protection Cover | |
| F39-HJ□□□□ | For F3SJ-A series sensor, reduces operating range by 10%, includes two pieces for emitter and receiver |
| Water-Resistant Case (Set of 1 tube, packing, and dedicated connector cable) When using for both emitter and receiver, order two sets. | |
| F39-EJ□□□□-L | Water-resistant case for emitter, includes gray cable for emitter |
| F39-EJ□□□□-D | Water-resistant case for receiver, includes black cable for receiver |
| F39-EJ-R ⁶ | Rear mounting brackets, top/bottom 1 each, total of 2 |
| F39-EJ-S ⁶ | Side mounting brackets, top/bottom 1 each, total of 2 |
| F39-JJR3WE-L | Series connection cable for emitter, purchase additionally for series connection when using the water-resistant case |
| F39-JJR3WE-D | Series connection cable for receiver, purchase additionally for series connection when using the water-resistant case |
| Branch Connector for F3SX (F39-JC□T to F39-JC□B) | |
| F39-CN5 | Branch connector for F3SX |
| Wire-Saving Devices | |
| F39-CN8 | Short-circuit connector |
| F39-TC5P01 | Connector terminal box with muting sensor output mode (PNP) |
| F39-TC5P02 | Connector terminal box with override mode (PNP) |
| F39-TC5N01 | Connector terminal box with muting sensor output mode (NPN) |
| F39-TC5N02 | Connector terminal box with override mode (NPN) |
| F3SP-T01 | Safety terminal relays for F3SJ-A_ _P_ |
| Laser Alignment Tool | |
| F39-PTJ | Laser alignment tool for the F3SJ |

⁵ The setting tools described above can be connected only to F3SJ-A models with built-in software of Ver. 2 or later. Note that the setting tools cannot be used with products shipped prior to December 2005. The setting tools cannot be used for setting parameters on the F3SJ-A□-TS series, but the monitoring function can be used.

⁶ Be sure to purchase brackets with the case to match the mounting direction (rear or side).

 = Highlighted **Rapid Delivery** products are available for shipment today or within **THREE** days.



D



Компания «ЭлектроПласт» предлагает заключение долгосрочных отношений при поставках импортных электронных компонентов на взаимовыгодных условиях!

Наши преимущества:

- Оперативные поставки широкого спектра электронных компонентов отечественного и импортного производства напрямую от производителей и с крупнейших мировых складов;
- Поставка более 17-ти миллионов наименований электронных компонентов;
- Поставка сложных, дефицитных, либо снятых с производства позиций;
- Оперативные сроки поставки под заказ (от 5 рабочих дней);
- Экспресс доставка в любую точку России;
- Техническая поддержка проекта, помощь в подборе аналогов, поставка прототипов;
- Система менеджмента качества сертифицирована по Международному стандарту ISO 9001;
- Лицензия ФСБ на осуществление работ с использованием сведений, составляющих государственную тайну;
- Поставка специализированных компонентов (Xilinx, Altera, Analog Devices, Intersil, Interpoint, Microsemi, Aeroflex, Peregrine, Syfer, Eurofarad, Texas Instrument, Miteq, Cobham, E2V, MA-COM, Hittite, Mini-Circuits, General Dynamics и др.);

Помимо этого, одним из направлений компании «ЭлектроПласт» является направление «Источники питания». Мы предлагаем Вам помощь Конструкторского отдела:

- Подбор оптимального решения, техническое обоснование при выборе компонента;
- Подбор аналогов;
- Консультации по применению компонента;
- Поставка образцов и прототипов;
- Техническая поддержка проекта;
- Защита от снятия компонента с производства.



Как с нами связаться

Телефон: 8 (812) 309 58 32 (многоканальный)

Факс: 8 (812) 320-02-42

Электронная почта: org@eplast1.ru

Адрес: 198099, г. Санкт-Петербург, ул. Калинина, дом 2, корпус 4, литера А.