

# SIOV metal oxide varistors

Block varistors, HighE series

**Series/Type:** B722\*

**Date:** January 2018

© EPCOS AG 2018. Reproduction, publication and dissemination of this publication, enclosures hereto and the information contained therein without EPCOS' prior express consent is prohibited.

EPCOS AG is a TDK Group Company.

**HighE series**
**Construction**

- Disk-shaped varistor element, potted in plastic housing
- Housing and potting flame-retardant to UL 94 V-0
- Screw terminals M4 (SIOV-B32 ... 40)  
Screw terminals M5 (SIOV-B60 ... 80)

**Features**

- Heavy-duty varistors (surge current capability up to 100 kA)
- Wide operating voltage range 75 ... 1100 V<sub>RMS</sub>
- SIOV-B40 also available without housing (LS40 series)
- PSpice models

**Approvals**

- UL
- CSA (≥ K130)

**Delivery mode**

- Cardboard box

**General technical data**

Climatic category	to IEC 60068-1	40/85/56	
Operating temperature	to CECC 42 000	-40 ... + 85	°C
Storage temperature		-40 ... +110	°C
Electric strength	to CECC 42 000	≥ 2.5	kV <sub>RMS</sub>
Insulation resistance	to CECC 42 000	≥ 10	MΩ
Maximum torque for B32 and B40 types		1.0	Nm
Maximum torque for B60 and B80 types		2.5	Nm

**Block varistors**
**B722\***
**HighE series**
**Electrical specifications and ordering codes**
**Maximum ratings ( $T_A = 85\text{ }^\circ\text{C}$ )**

Ordering code	Type	$V_{RMS}$ V	$V_{DC}$ V	$i_{max}$ (8/20 $\mu$ s) A	$W_{max}$ (2 ms) J	$P_{max}$ W
$V_{RMS} = 75\text{ V}$						
B72240B0750K001	B40K75	75	100	25000	190	1.4
$V_{RMS} = 130\text{ V}$						
B72232B0131K001	B32K130	130	170	25000	210	1.2
B72240B0131K001	B40K130	130	170	40000	310	1.4
B72260B0131K001	B60K130	130	170	70000	490	1.6
B72280B0131K001	B80K130	130	170	100000	660	2.0
$V_{RMS} = 150\text{ V}$						
B72232B0151K001	B32K150	150	200	25000	240	1.2
B72240B0151K001	B40K150	150	200	40000	360	1.4
B72260B0151K001	B60K150	150	200	70000	570	1.6
B72280B0151K001	B80K150	150	200	100000	800	2.0
$V_{RMS} = 230\text{ V}$						
B72232B0231K001	B32K230	230	300	25000	300	1.2
B72240B0231K001	B40K230	230	300	40000	460	1.4
B72260B0231K001	B60K230	230	300	70000	730	1.6
B72280B0231K001	B80K230	230	300	100000	1200	2.0
$V_{RMS} = 250\text{ V}$						
B72232B0251K001	B32K250	250	320	25000	330	1.2
B72240B0251K001	B40K250	250	320	40000	490	1.4
B72260B0251K001	B60K250	250	320	70000	800	1.6
B72280B0251K001	B80K250	250	320	100000	1300	2.0
$V_{RMS} = 275\text{ V}$						
B72232B0271K001	B32K275	275	350	25000	360	1.2
B72240B0271K001	B40K275	275	350	40000	550	1.4
B72260B0271K001	B60K275	275	350	70000	860	1.6
B72280B0271K001	B80K275	275	350	100000	1400	2.0
$V_{RMS} = 320\text{ V}$						
B72232B0321K001	B32K320	320	420	25000	430	1.2
B72240B0321K001	B40K320	320	420	40000	640	1.4
B72260B0321K001	B60K320	320	420	70000	1000	1.6
B72280B0321K001	B80K320	320	420	100000	1600	2.0

Varistor elements without plastic housing (suitable for soldering) are available upon request.

**Block varistors**
**B722\***
**HighE series**
**Characteristics (T<sub>A</sub> = 25 °C)**

Ordering code	V <sub>v</sub> (1 mA) V	ΔV <sub>v</sub> (1 mA) %	V <sub>C,max</sub> (i <sub>c</sub> ) V	i <sub>c</sub> A	C <sub>typ</sub> (1 kHz) pF
<b>V<sub>RMS</sub> = 75 V</b>					
B72240B0750K001	120	±10	220	300	11000
<b>V<sub>RMS</sub> = 130 V</b>					
B72232B0131K001	205	±10	340	200	4400
B72240B0131K001	205	±10	340	300	5600
B72260B0131K001	205	±10	340	500	15000
B72280B0131K001	205	±10	340	800	28000
<b>V<sub>RMS</sub> = 150 V</b>					
B72232B0151K001	240	±10	395	200	3700
B72240B0151K001	240	±10	395	300	4800
B72260B0151K001	240	±10	395	500	12000
B72280B0151K001	240	±10	395	800	23000
<b>V<sub>RMS</sub> = 230 V</b>					
B72232B0231K001	360	±10	595	200	2500
B72240B0231K001	360	±10	595	300	3200
B72260B0231K001	360	±10	595	500	7900
B72280B0231K001	360	±10	595	800	16000
<b>V<sub>RMS</sub> = 250 V</b>					
B72232B0251K001	390	±10	650	200	2200
B72240B0251K001	390	±10	650	300	2900
B72260B0251K001	390	±10	650	500	7100
B72280B0251K001	390	±10	650	800	14000
<b>V<sub>RMS</sub> = 275 V</b>					
B72232B0271K001	430	±10	710	200	2000
B72240B0271K001	430	±10	710	300	2700
B72260B0271K001	430	±10	710	500	6600
B72280B0271K001	430	±10	710	800	13000
<b>V<sub>RMS</sub> = 320 V</b>					
B72232B0321K001	510	±10	840	200	1700
B72240B0321K001	510	±10	840	300	2300
B72260B0321K001	510	±10	840	500	5600
B72280B0321K001	510	±10	840	800	11000

Varistor elements without plastic housing (suitable for soldering) are available upon request.

**Electrical specifications and ordering codes**
**Maximum ratings ( $T_A = 85\text{ }^\circ\text{C}$ )**

Ordering code	Type	$V_{RMS}$ V	$V_{DC}$ V	$i_{max}$ (8/20 $\mu$ s) A	$W_{max}$ (2 ms) J	$P_{max}$ W
<b><math>V_{RMS} = 385\text{ V}</math></b>						
B72232B0381K001	B32K385	385	505	25000	550	1.2
B72240B0381K001	B40K385	385	505	40000	800	1.4
B72260B0381K001	B60K385	385	505	70000	1200	1.6
B72280B0381K001	B80K385	385	505	100000	2000	2.0
<b><math>V_{RMS} = 420\text{ V}</math></b>						
B72232B0421K001	B32K420	420	560	25000	600	1.2
B72240B0421K001	B40K420	420	560	40000	910	1.4
B72260B0421K001	B60K420	420	560	70000	1500	1.6
B72280B0421K001	B80K420	420	560	100000	2200	2.0
<b><math>V_{RMS} = 440\text{ V}</math></b>						
B72232B0441K001	B32K440	440	585	25000	630	1.2
B72240B0441K001	B40K440	440	585	40000	950	1.4
B72260B0441K001	B60K440	440	585	70000	1580	1.6
B72280B0441K001	B80K440	440	585	100000	2350	2.0
<b><math>V_{RMS} = 460\text{ V}</math></b>						
B72232B0461K001	B32K460	460	615	25000	660	1.2
B72240B0461K001	B40K460	460	615	40000	1000	1.4
B72260B0461K001	B60K460	460	615	70000	1650	1.6
B72280B0461K001	B80K460	460	615	100000	2500	2.0
<b><math>V_{RMS} = 550\text{ V}</math></b>						
B72232B0551K001	B32K550	550	745	25000	620	1.2
B72240B0551K001	B40K550	550	745	40000	960	1.4
B72260B0551K001	B60K550	550	745	70000	1500	1.6
B72280B0551K001	B80K550	550	745	100000	3100	2.0
<b><math>V_{RMS} = 680\text{ V}</math></b>						
B72232B0681K001	B32K680	680	895	25000	760	1.2
B72240B0681K001	B40K680	680	895	40000	1100	1.4
B72260B0681K001	B60K680	680	895	70000	1800	1.6
B72280B0681K001	B80K680	680	895	100000	3600	2.0

Varistor elements without plastic housing (suitable for soldering) are available upon request.

**Block varistors**
**B722\***
**HighE series**
**Characteristics (T<sub>A</sub> = 25 °C)**

Ordering code	V <sub>v</sub> (1 mA) V	ΔV <sub>v</sub> (1 mA) %	V <sub>C,max</sub> (i <sub>c</sub> ) V	i <sub>c</sub> A	C <sub>typ</sub> (1 kHz) pF
<b>V<sub>RMS</sub> = 385 V</b>					
B72232B0381K001	620	±10	1025	200	1400
B72240B0381K001	620	±10	1025	300	1900
B72260B0381K001	620	±10	1025	500	4600
B72280B0381K001	620	±10	1025	800	9000
<b>V<sub>RMS</sub> = 420 V</b>					
B72232B0421K001	680	±10	1120	200	1300
B72240B0421K001	680	±10	1120	300	1800
B72260B0421K001	680	±10	1120	500	4300
B72280B0421K001	680	±10	1120	800	8500
<b>V<sub>RMS</sub> = 440 V</b>					
B72232B0441K001	715	±10	1180	200	1250
B72240B0441K001	715	±10	1180	300	1700
B72260B0441K001	715	±10	1180	500	4100
B72280B0441K001	715	±10	1180	800	8100
<b>V<sub>RMS</sub> = 460 V</b>					
B72232B0461K001	750	±10	1240	200	1200
B72240B0461K001	750	±10	1240	300	1600
B72260B0461K001	750	±10	1240	500	3900
B72280B0461K001	750	±10	1240	800	7700
<b>V<sub>RMS</sub> = 550 V</b>					
B72232B0551K001	910	±10	1500	200	1000
B72240B0551K001	910	±10	1500	300	1400
B72260B0551K001	910	±10	1500	500	3300
B72280B0551K001	910	±10	1500	800	6500
<b>V<sub>RMS</sub> = 680 V</b>					
B72232B0681K001	1100	±10	1815	200	830
B72240B0681K001	1100	±10	1815	300	1100
B72260B0681K001	1100	±10	1815	500	2600
B72280B0681K001	1100	±10	1815	800	5200

Varistor elements without plastic housing (suitable for soldering) are available upon request.

**Electrical specifications and ordering codes**
**Maximum ratings ( $T_A = 85\text{ °C}$ )**

Ordering code	Type	$V_{RMS}$	$V_{DC}$	$i_{max}$ (8/20 $\mu$ s)	$W_{max}$ (2 ms)	$P_{max}$
	SIOV-	V	V	A	J	W
$V_{RMS} = 750\text{ V}$						
B72232B0751K001	B32K750	750	970	25000	800	1.2
B72240B0751K001	B40K750	750	970	40000	1200	1.4
B72260B0751K001	B60K750	750	970	70000	2000	1.6
B72280B0751K001	B80K750	750	970	100000	4000	2.0
$V_{RMS} = 1100\text{ V}$						
B72260B0102K001	B60K1000 <sup>1)</sup>	1100	1465	70000	3000	1.6
B72280B0112K001	B80K1100	1100	1465	100000	6000	2.0

**Characteristics ( $T_A = 25\text{ °C}$ )**

Ordering code	$V_v$ (1 mA)	$\Delta V_v$ (1 mA)	$V_{c,max}$ ( $i_c$ )	$i_c$	$C_{typ}$ (1 kHz)
	V	%	V	A	pF
$V_{RMS} = 750\text{ V}$					
B72232B0751K001	1200	$\pm 10$	2000	200	800
B72240B0751K001	1200	$\pm 10$	2000	300	1000
B72260B0751K001	1200	$\pm 10$	2000	500	2400
B72280B0751K001	1200	$\pm 10$	2000	800	4800
$V_{RMS} = 1100\text{ V}$					
B72260B0102K001	1800	$\pm 10$	2970	500	1600
B72280B0112K001	1800	$\pm 10$	2970	800	3200

Varistor elements without plastic housing (suitable for soldering) are available upon request.

1) Operating voltage differs from type designation

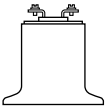

**Block varistors**

**B722\***

**HighE series**

**Dimensional drawings**

**SIOV-B32/-B40**

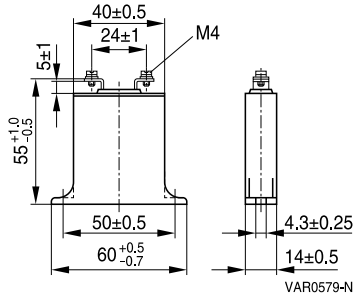

**Weight**

Nominal diameter mm	V <sub>RMS</sub> V	Weight g
32	130 ... 750	45
40	75 ... 750	50
60	130 ... 1100	250
80	130 ... 1100	650

**SIOV-B60**

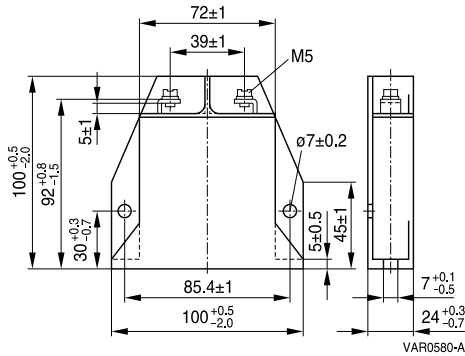

**SIOV-B80**

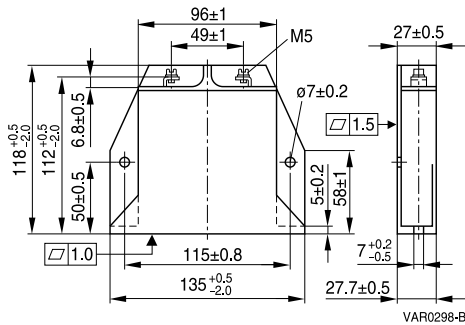

Dimensions in mm



**Reliability data**

Test	Test methods/conditions	Requirement
Varistor voltage	The voltage between two terminals with the specified measuring current applied is called $V_V$ (1 mA <sub>DC</sub> @ 0.2 ... 2 s).	To meet the specified value
Clamping voltage	The maximum voltage between two terminals with the specified standard impulse current (8/20 $\mu$ s) applied.	To meet the specified value
Max. DC operating voltage	The maximum allowable DC operating voltage $V_{DC}$ at UCT +5/-0 °C is applied for 1000 $\pm$ 48 h. The leakage current $I_{leak}$ (t) during test is recorded. Then the specimen shall be stored at room temperature and normal humidity for 1 to 2 h. Thereafter, the change of $V_V$ shall be measured.	$I_{leak}$ (t = 1000 h) $\leq$ $I_{leak}$ (t = 0 h) $ \Delta V/V$ (1 mA) $\leq$ 10%
Surge current derating, 8/20 $\mu$ s	10 surge currents (8/20 $\mu$ s), unipolar, interval $\geq$ 60 s, amplitude corresponding to derating curve for 10 impulses at 20 $\mu$ s	$ \Delta V/V$ (1 mA) $\leq$ 10% (measured in direction of surge current) No visible damage
Fast temperature cycling	IEC 60068-2-14, test Na, LCT/UCT, dwell time 120 min, 5 cycles	$ \Delta V/V$ (1 mA) $\leq$ 10% No visible damage
Damp heat, steady state	IEC 60068-2-78  The specimen shall be subjected to 40 $\pm$ 2 °C, 90 to 95% r. H. for 56 $\pm$ 2 days with 10% of the maximum continuous DC operating voltage $V_{DC}$ . Then stored at room temperature and normal humidity for 1 to 2 h. Thereafter, the change of $V_V$ shall be measured.	$ \Delta V/V$ (1 mA) $\leq$ 10%

**Note:**

UCT = Upper category temperature

LCT = Lower category temperature



**v/i characteristics**

$v = f(i)$  for explanation of the characteristics refer to "General technical information", chapter 1.6.3  
 A = Leakage current, B = Protection level } for worst-case varistor tolerances

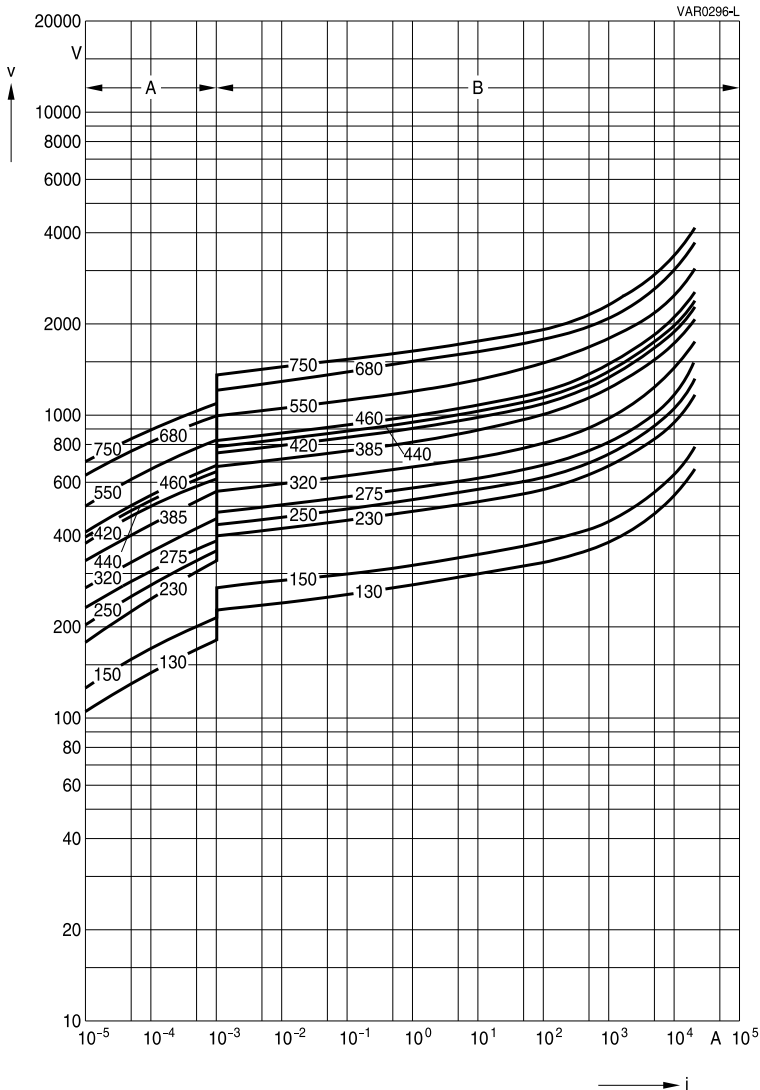

**SIOV-B32K130 ... K750**



**v/i characteristics**

$v = f(i)$  for explanation of the characteristics refer to "General technical information", chapter 1.6.3  
 A = Leakage current, B = Protection level } for worst-case varistor tolerances

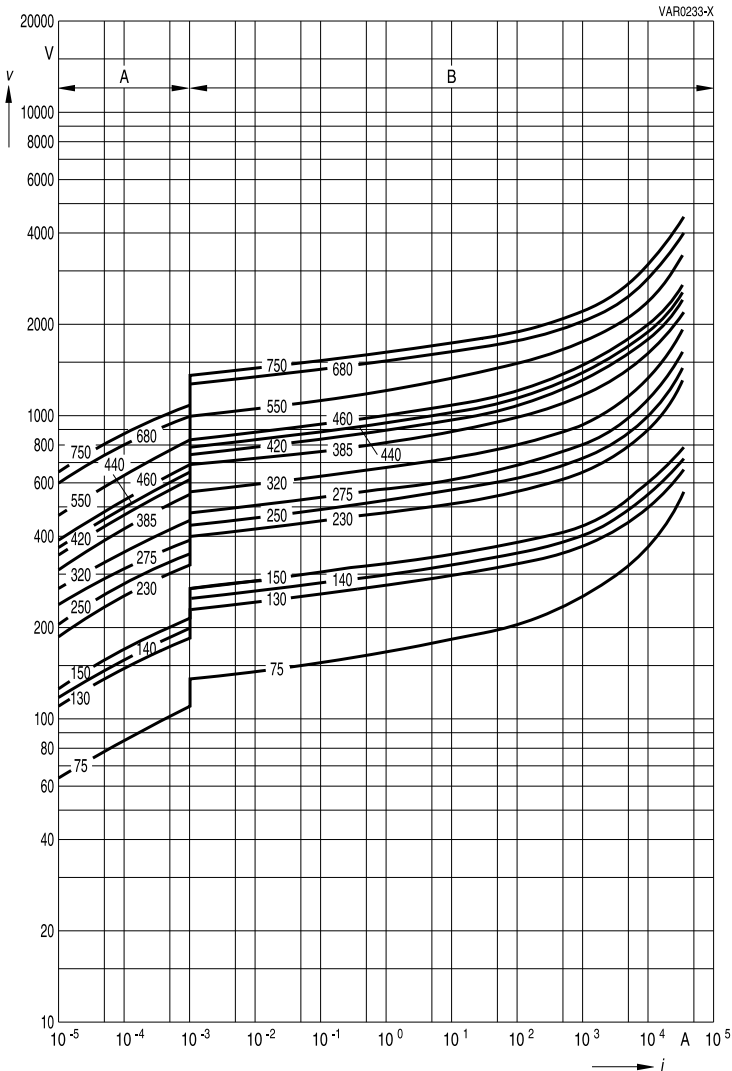

**SIOV-B40K75 ... K750**

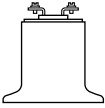

**v/i characteristics**

$v = f(i)$  for explanation of the characteristics refer to "General technical information", chapter 1.6.3  
 A = Leakage current, B = Protection level } for worst-case varistor tolerances

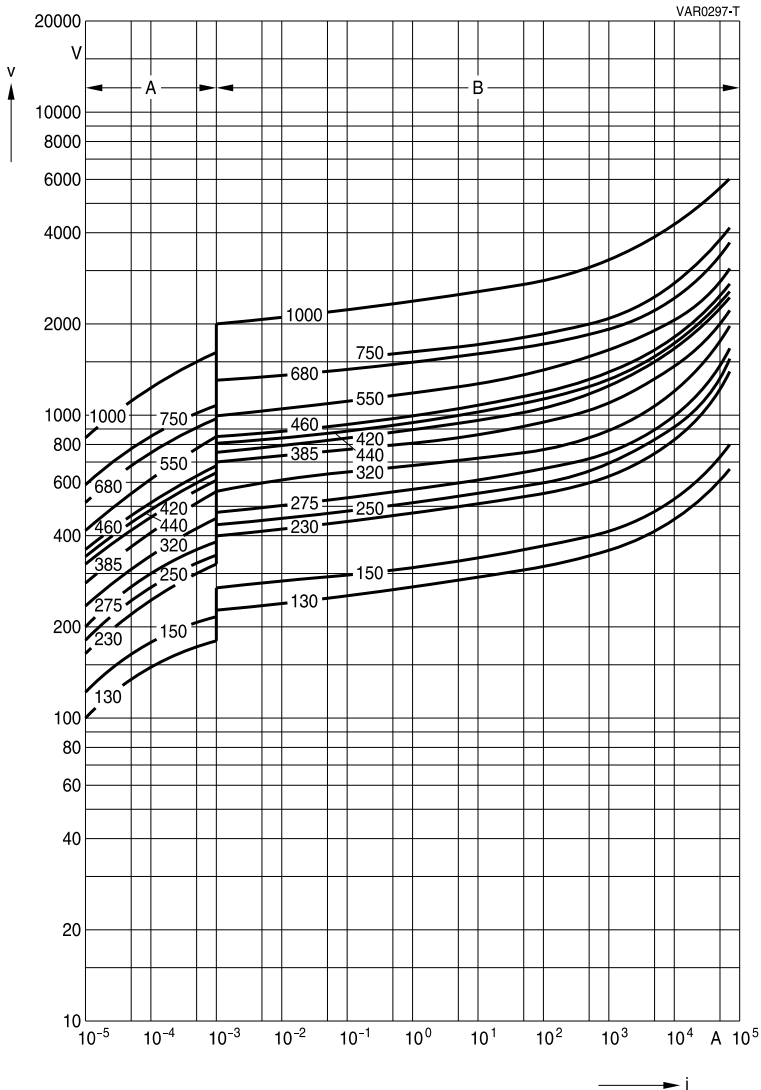

**SIOV-B60K130 ... K1000**



**v/i characteristics**

$v = f(i)$  for explanation of the characteristics refer to "General technical information", chapter 1.6.3  
 A = Leakage current, B = Protection level } for worst-case varistor tolerances



**SIOV-B80K130 ... K1100**



**Derating curves**

Maximum surge current  $i_{max} = f(t_r, \text{pulse train})$

For explanation of the derating curves refer to "General technical information", section 1.8.1

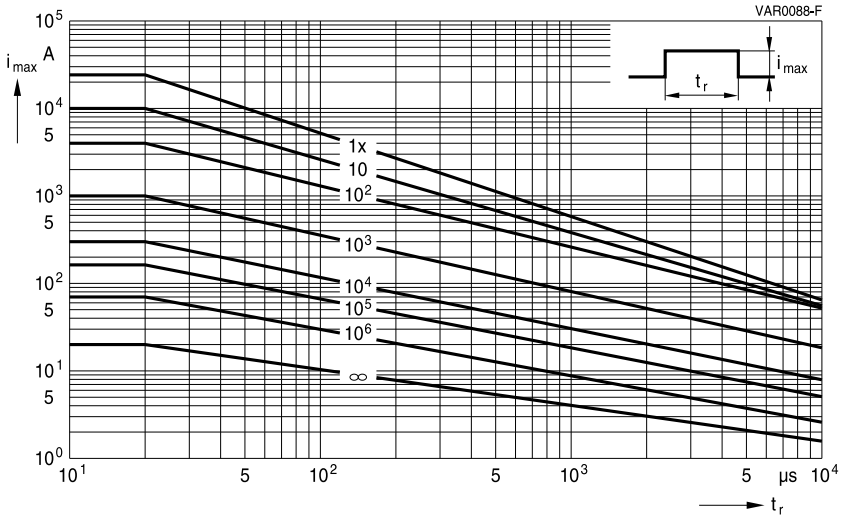

**SIOV-B32K130 ... K150**

**SIOV-B40K75**

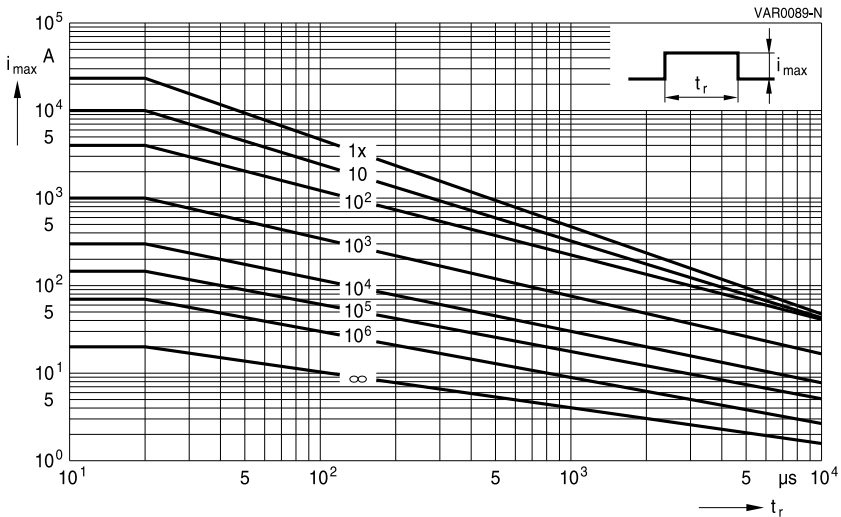

**SIOV-B32K230 ... K460**

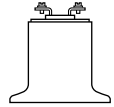

**Derating curves**

Maximum surge current  $i_{max} = f(t_r, \text{pulse train})$

For explanation of the derating curves refer to "General technical information", section 1.8.1

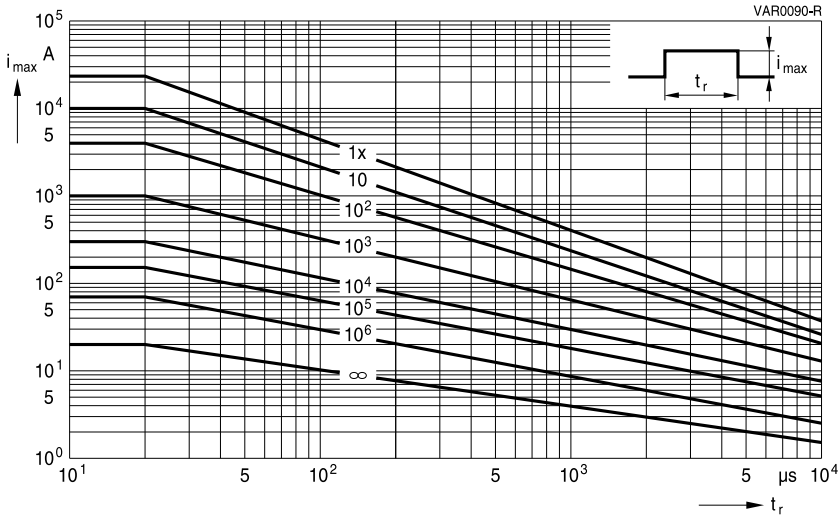

**SIOV-B32K550 ... K750**

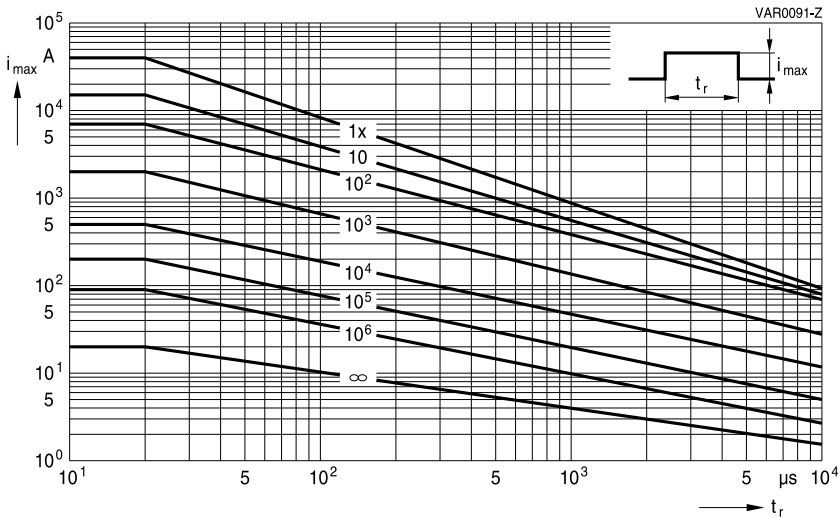

**SIOV-B40K130 ... K150**



**Derating curves**

Maximum surge current  $i_{max} = f(t_r, \text{pulse train})$

For explanation of the derating curves refer to "General technical information", section 1.8.1

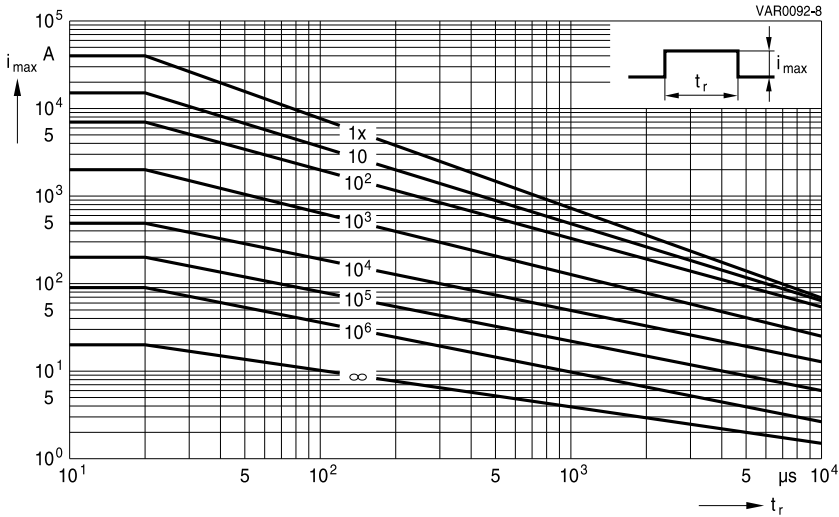

**SIOV-B40K230 ... K460**

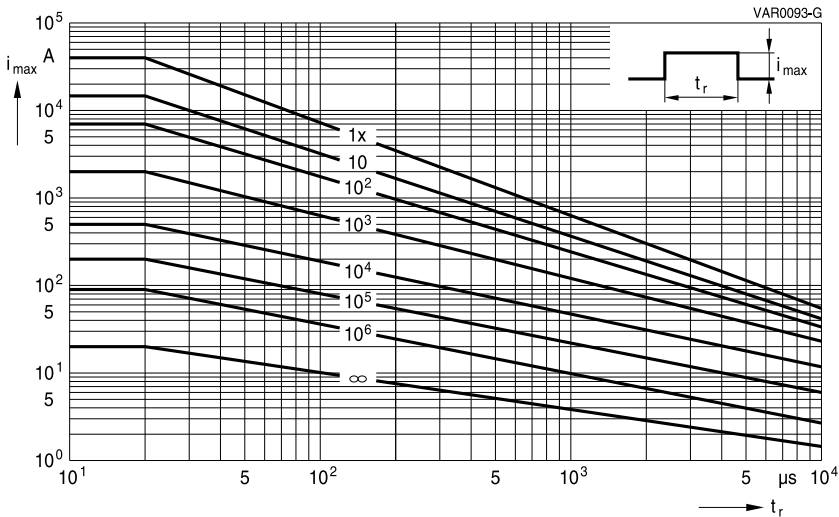

**SIOV-B40K550 ... K750**





**Derating curves**

Maximum surge current  $i_{max} = f(t_r, \text{pulse train})$

For explanation of the derating curves refer to "General technical information", section 1.8.1



**SIOV-B60K130 ... K150**



**SIOV-B60K230 ... K460**

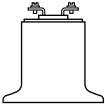

**Derating curves**

Maximum surge current  $i_{max} = f(t_r, \text{pulse train})$

For explanation of the derating curves refer to "General technical information", section 1.8.1



**SIOV-B60K550 ... K1000**

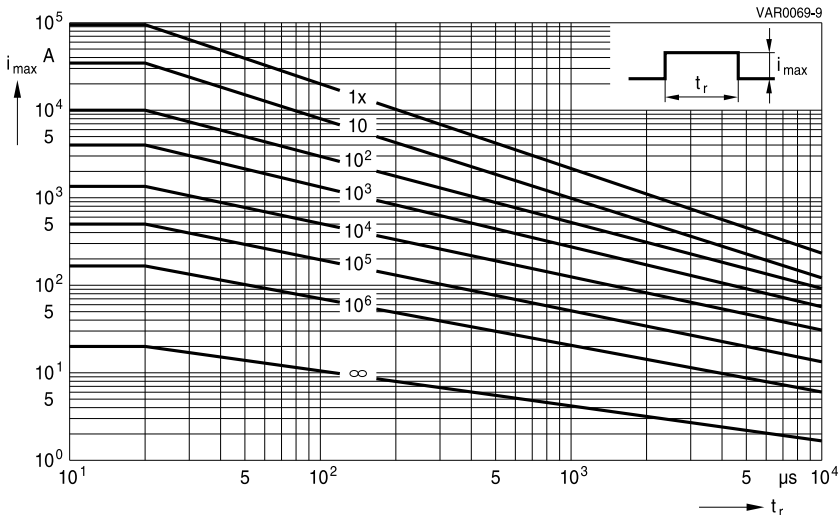

**SIOV-B80K130 ... K1100**

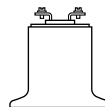

## Cautions and warnings

### General

1. EPCOS metal oxide varistors are designed for specific applications and should not be used for purposes not identified in our specifications, application notes and data books unless otherwise agreed with EPCOS during the design-in-phase.
2. Ensure suitability of SIOVs through reliability testing during the design-in phase. SIOVs should be evaluated taking into consideration worst-case conditions.
3. For applications of SIOVs in line-to-ground circuits based on various international and local standards there are restrictions existing or additional safety measures required.

### Storage

1. Store SIOVs only in original packaging. Do not open the package prior to processing.
2. Recommended storage conditions in original packaging:  
 Storage temperature:  $-25\text{ °C} \dots +45\text{ °C}$ ,  
 Relative humidity:  $<75\%$  annual average,  
 $<95\%$  on maximum 30 days a year.  
 Dew precipitation: is to be avoided.
3. Avoid contamination of an SIOV's during storage, handling and processing.
4. Avoid storage of SIOVs in harmful environments that can affect the function during long-term operation (examples given under operation precautions).
5. The SIOV type series should be soldered after shipment from EPCOS within the time specified:
 

SIOV-S, -Q, -LS, -B, -SNF	24 months
ETFV/ T series, -CU	12 months.

### Handling

1. SIOVs must not be dropped.
2. Components must not be touched with bare hands. Gloves are recommended.
3. Avoid contamination of the surface of SIOV electrodes during handling, be careful of the sharp edge of SIOV electrodes.

### Soldering (where applicable)

1. Use rosin-type flux or non-activated flux.
2. Insufficient preheating may cause ceramic cracks.
3. Rapid cooling by dipping in solvent is not recommended.
4. Complete removal of flux is recommended.
5. Temperatures of all preheat stages and the solder bath must be strictly controlled especially for T series (T14 and T20).



## Mounting

1. Potting, sealing or adhesive compounds can produce chemical reactions in the SIOV ceramic that will degrade the component's electrical characteristics.
2. Overloading SIOVs may result in ruptured packages and expulsion of hot materials. For this reason SIOVs should be physically shielded from adjacent components.

## Operation

1. Use SIOVs only within the specified temperature operating range.
2. Use SIOVs only within the specified voltage and current ranges.
3. Environmental conditions must not harm SIOVs. Use SIOVs only in normal atmospheric conditions. Avoid use in deoxidizing gases (chlorine gas, hydrogen sulfide gas, ammonia gas, sulfuric acid gas etc), corrosive agents, humid or salty conditions. Contact with any liquids and solvents should be prevented.

## Display of ordering codes for EPCOS products

The ordering code for one and the same EPCOS product can be represented differently in data sheets, data books, other publications, on the EPCOS website, or in order-related documents such as shipping notes, order confirmations and product labels. **The varying representations of the ordering codes are due to different processes employed and do not affect the specifications of the respective products.** Detailed information can be found on the Internet under [www.epcos.com/orderingcodes](http://www.epcos.com/orderingcodes)

**Symbols and terms**

Symbol	Term
C	Capacitance
$C_{typ}$	Typical capacitance
i	Current
$i_c$	Current at which $V_{c, max}$ is measured
$I_{leak}$	Leakage current
$i_{max}$	Maximum surge current (also termed peak current)
$I_{max}$	Maximum discharge current
$I_n$	Nominal discharge current to UL 1449
LCT	Lower category temperature
$L_{typ}$	Typical inductance
$P_{max}$	Maximum average power dissipation
$R_{ins}$	Insulation resistance
$R_{min}$	Minimum resistance
$T_A$	Ambient temperature
$t_r$	Duration of equivalent rectangular wave
UCT	Upper category temperature
v	Voltage
$V_{clamp}$	Clamping voltage
$V_{c, max}$	Maximum clamping voltage at specified current $i_c$
$V_{DC}$	DC operating voltage
$V_{jump}$	Maximum jump start voltage
$V_{max}$	Maximum voltage
$V_{op}$	Operating voltage
$V_{RMS}$	AC operating voltage, root-mean-square value
$V_{RMS, op, max}$	Root-mean-square value of max. DC operating voltage incl. ripple current
$V_{surge}$	Super imposed surge voltage
$V_V$	Varistor voltage
$\Delta V_V$	Tolerance of varistor voltage
$W_{LD}$	Maximum load dump
$W_{max}$	Maximum energy absorption
$e$	Lead spacing

All dimensions are given in mm.

The commas used in numerical values denote decimal points.

## Important notes

The following applies to all products named in this publication:

1. Some parts of this publication contain **statements about the suitability of our products for certain areas of application**. These statements are based on our knowledge of typical requirements that are often placed on our products in the areas of application concerned. We nevertheless expressly point out **that such statements cannot be regarded as binding statements about the suitability of our products for a particular customer application**. As a rule we are either unfamiliar with individual customer applications or less familiar with them than the customers themselves. For these reasons, it is always ultimately incumbent on the customer to check and decide whether a product with the properties described in the product specification is suitable for use in a particular customer application.
2. We also point out that **in individual cases, a malfunction of electronic components or failure before the end of their usual service life cannot be completely ruled out in the current state of the art, even if they are operated as specified**. In customer applications requiring a very high level of operational safety and especially in customer applications in which the malfunction or failure of an electronic component could endanger human life or health (e.g. in accident prevention or life-saving systems), it must therefore be ensured by means of suitable design of the customer application or other action taken by the customer (e.g. installation of protective circuitry or redundancy) that no injury or damage is sustained by third parties in the event of malfunction or failure of an electronic component.
3. **The warnings, cautions and product-specific notes must be observed.**
4. In order to satisfy certain technical requirements, **some of the products described in this publication may contain substances subject to restrictions in certain jurisdictions (e.g. because they are classed as hazardous)**. Useful information on this will be found in our Material Data Sheets on the Internet ([www.tdk-electronics.tdk.com/material](http://www.tdk-electronics.tdk.com/material)). Should you have any more detailed questions, please contact our sales offices.
5. We constantly strive to improve our products. Consequently, **the products described in this publication may change from time to time**. The same is true of the corresponding product specifications. Please check therefore to what extent product descriptions and specifications contained in this publication are still applicable before or when you place an order.  
  
We also **reserve the right to discontinue production and delivery of products**. Consequently, we cannot guarantee that all products named in this publication will always be available. The aforementioned does not apply in the case of individual agreements deviating from the foregoing for customer-specific products.
6. Unless otherwise agreed in individual contracts, **all orders are subject to our General Terms and Conditions of Supply**.
7. **Our manufacturing sites serving the automotive business apply the IATF 16949 standard**. The IATF certifications confirm our compliance with requirements regarding the quality management system in the automotive industry. Referring to customer requirements and customer specific requirements ("CSR") TDK always has and will continue to have the policy of respecting individual agreements. Even if IATF 16949 may appear to support the acceptance of unilateral requirements, we hereby like to emphasize that **only requirements mutually agreed upon can and will be implemented in our Quality Management System**. For clarification purposes we like to point out that obligations from IATF 16949 shall only become legally binding if individually agreed upon.

## Important notes

8. The trade names EPCOS, CeraCharge, CeraDiode, CeraLink, CeraPad, CeraPlas, CSMP, CTVS, DeltaCap, DigiSiMic, ExoCore, FilterCap, FormFit, LeaXield, MiniBlue, MiniCell, MKD, MKK, MotorCap, PCC, PhaseCap, PhaseCube, PhaseMod, PhiCap, PowerHap, PQSine, PQvar, SIFERRIT, SIFI, SIKOREL, SilverCap, SIMDAD, SiMic, SIMID, SineFormer, SIOV, ThermoFuse, WindCap are **trademarks registered or pending** in Europe and in other countries. Further information will be found on the Internet at [www.tdk-electronics.tdk.com/trademarks](http://www.tdk-electronics.tdk.com/trademarks).

Release 2018-10

# Mouser Electronics

Authorized Distributor

Click to View Pricing, Inventory, Delivery & Lifecycle Information:

## EPCOS / TDK:

[B72232B0131K001](#) [B72232B0231K001](#) [B72232B0251K001](#) [B72232B0271K001](#) [B72232B0321K001](#)  
[B72232B0381K001](#) [B72232B0421K001](#) [B72232B0441K001](#) [B72232B0461K001](#) [B72232B0681K001](#)  
[B72232B0751K001](#) [B72240B0441K001](#) [B72240B0681K001](#) [B72260B0102K001](#) [B72260B0131K001](#)  
[B72260B0151K001](#) [B72260B0231K001](#) [B72260B0251K001](#) [B72260B0271K001](#) [B72260B0321K001](#)  
[B72260B0381K001](#) [B72260B0421K001](#) [B72260B0441K001](#) [B72260B0461K001](#) [B72260B0551K001](#)  
[B72260B0681K001](#) [B72260B0751K001](#) [B72280B0112K001](#) [B72280B0131K001](#) [B72280B0151K001](#)  
[B72280B0231K001](#) [B72280B0251K001](#) [B72280B0271K001](#) [B72280B0321K001](#) [B72280B0381K001](#)  
[B72280B0421K001](#) [B72280B0441K001](#) [B72280B0461K001](#) [B72280B0551K001](#) [B72280B0681K001](#)  
[B72280B0751K001](#) [B72240B0750K001](#) [B72240B0421K001](#) [B72240B0231K001](#) [B72232B0551K001](#)  
[B72232B0151K001](#) [B72240B0321K001](#) [B72240B0151K001](#) [B72240B0461K001](#) [B72240B0381K001](#)  
[B72240B0751K001](#) [B72240B0131K001](#) [B72240B0251K001](#) [B72240B0551K001](#) [B72240B0271K001](#)  
[B72232B0750K001](#)





Компания «ЭлектроПласт» предлагает заключение долгосрочных отношений при поставках импортных электронных компонентов на взаимовыгодных условиях!

Наши преимущества:

- Оперативные поставки широкого спектра электронных компонентов отечественного и импортного производства напрямую от производителей и с крупнейших мировых складов;
- Поставка более 17-ти миллионов наименований электронных компонентов;
- Поставка сложных, дефицитных, либо снятых с производства позиций;
- Оперативные сроки поставки под заказ (от 5 рабочих дней);
- Экспресс доставка в любую точку России;
- Техническая поддержка проекта, помощь в подборе аналогов, поставка прототипов;
- Система менеджмента качества сертифицирована по Международному стандарту ISO 9001;
- Лицензия ФСБ на осуществление работ с использованием сведений, составляющих государственную тайну;
- Поставка специализированных компонентов (Xilinx, Altera, Analog Devices, Intersil, Interpoint, Microsemi, Aeroflex, Peregrine, Syfer, Eurofarad, Texas Instrument, Miteq, Cobham, E2V, MA-COM, Hittite, Mini-Circuits, General Dynamics и др.);

Помимо этого, одним из направлений компании «ЭлектроПласт» является направление «Источники питания». Мы предлагаем Вам помощь Конструкторского отдела:

- Подбор оптимального решения, техническое обоснование при выборе компонента;
- Подбор аналогов;
- Консультации по применению компонента;
- Поставка образцов и прототипов;
- Техническая поддержка проекта;
- Защита от снятия компонента с производства.



#### Как с нами связаться

**Телефон:** 8 (812) 309 58 32 (многоканальный)

**Факс:** 8 (812) 320-02-42

**Электронная почта:** [org@eplast1.ru](mailto:org@eplast1.ru)

**Адрес:** 198099, г. Санкт-Петербург, ул. Калинина, дом 2, корпус 4, литера А.