

## SuperSOT4™ DUAL 12V PNP SILICON LOW SATURATION SWITCHING TRANSISTOR

### SUMMARY

$V_{CE0} = -12V$ ;  $R_{SAT} = 47m\Omega$ ;  $I_C = -3A$

### DESCRIPTION

This new 4th generation ultra low saturation transistor utilises the Zetex matrix structure combined with advanced assembly techniques to give extremely low on state losses. This makes it ideal for high efficiency, low voltage switching applications.



**MSOP8**

### FEATURES

- Extremely Low Equivalent On Resistance
- Extremely Low Saturation Voltage
- $h_{FE}$  characterised up to 12A
- $I_C = 3A$  Continuous Collector Current
- MSOP8 package

### APPLICATIONS

- DC - DC Converters
- Power Management Functions
- Power switches
- Motor control

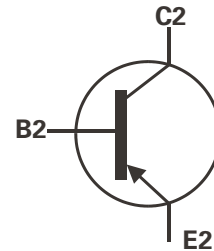
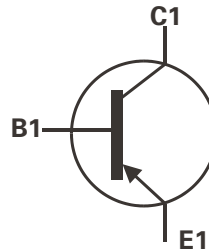

### ORDERING INFORMATION

DEVICE	REEL SIZE (inches)	TAPE WIDTH (mm)	QUANTITY PER REEL
ZXT12P12DXTA	7	12mm embossed	1000 units
ZXT12P12DXTC	13	12mm embossed	4000 units

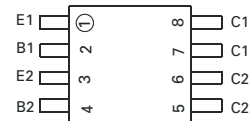

Top View

### DEVICE MARKING

T12P12DX

# ZXT12P12DX

## ABSOLUTE MAXIMUM RATINGS.

PARAMETER	SYMBOL	LIMIT	UNIT
Collector-Base Voltage	$V_{CBO}$	-20	V
Collector-Emitter Voltage	$V_{CEO}$	-12	V
Emitter-Base Voltage	$V_{EBO}$	-7.5	V
Peak Pulse Current	$I_{CM}$	-15	A
Continuous Collector Current	$I_C$	-3	A
Base Current	$I_B$	-500	mA
Power Dissipation at $T_A=25^\circ\text{C}$ (a)(d) Linear Derating Factor	$P_D$	0.87 6.9	W mW/ $^\circ\text{C}$
Power Dissipation at $T_A=25^\circ\text{C}$ (a)(e) Linear Derating Factor	$P_D$	1.04 8.3	W mW/ $^\circ\text{C}$
Power Dissipation at $T_A=25^\circ\text{C}$ (b)(d) Linear Derating Factor	$P_D$	1.25 10	W mW/ $^\circ\text{C}$
Operating and Storage Temperature Range	$T_j:T_{stg}$	-55 to +150	$^\circ\text{C}$

## THERMAL RESISTANCE

PARAMETER	SYMBOL	VALUE	UNIT
Junction to Ambient (a)(d)	$R_{\theta JA}$	143	$^\circ\text{C}/\text{W}$
Junction to Ambient (b)(d)	$R_{\theta JA}$	100	$^\circ\text{C}/\text{W}$
Junction to Ambient (a)(e)	$R_{\theta JA}$	120	$^\circ\text{C}/\text{W}$

## NOTES

(a) For a device surface mounted on 25mm x 25mm FR4 PCB with high coverage of single sided 1oz copper, in still air conditions

(b) For a device surface mounted on FR4 PCB measured at  $t \leq 5$  secs.

(c) Repetitive rating - pulse width limited by maximum junction temperature. Refer to Transient Thermal Impedance graph.

(d) For device with one active die.

(e) For device with two active die running at equal power.

# ZXT12P12DX

## CHARACTERISTICS

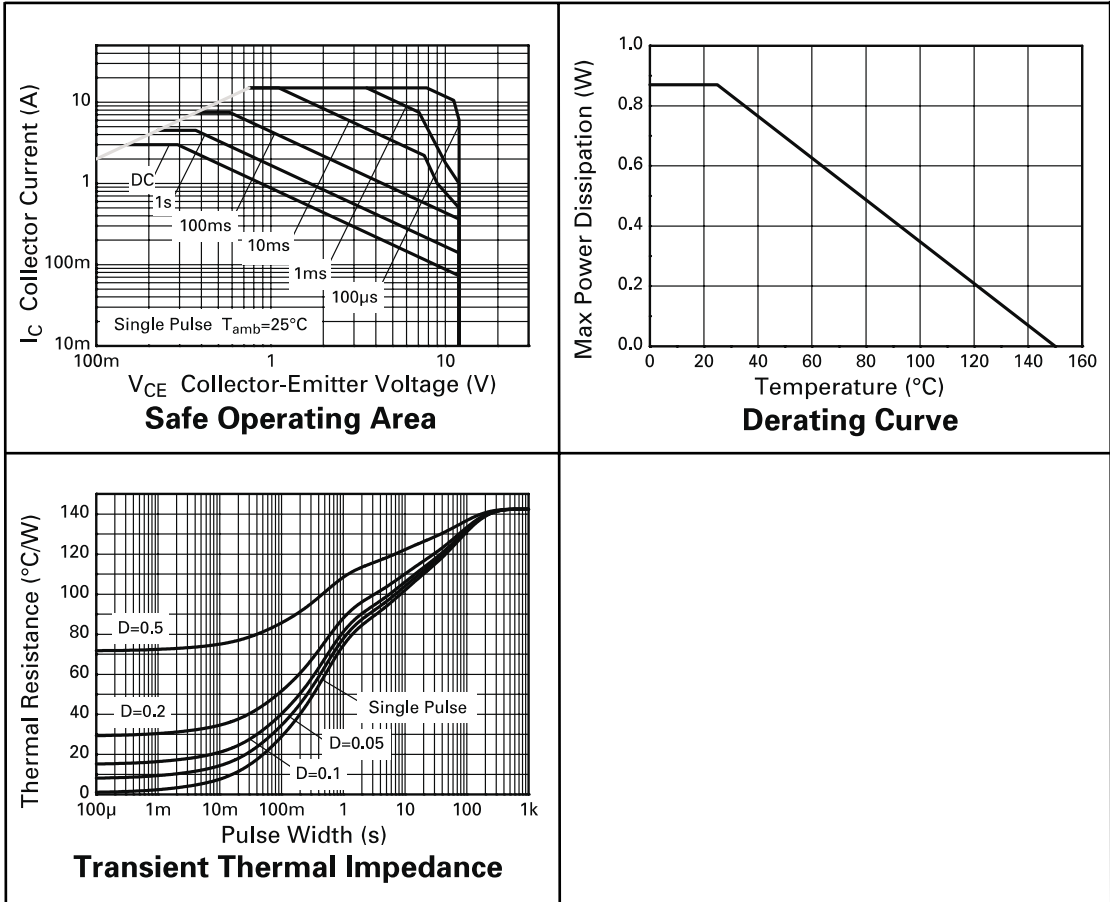

# ZXT12P12DX

## ELECTRICAL CHARACTERISTICS (at $T_{amb} = 25^{\circ}\text{C}$ unless otherwise stated).

PARAMETER	SYMBOL	MIN.	TYP.	MAX.	UNIT	CONDITIONS.
Collector-Base Breakdown Voltage	$V_{(BR)CBO}$	-20	-35		V	$I_C = -100\mu\text{A}$
Collector-Emitter Breakdown Voltage	$V_{(BR)CEO}$	-12	-28		V	$I_C = -10\text{mA}^*$
Emitter-Base Breakdown Voltage	$V_{(BR)EBO}$	-7.5	-8.5		V	$I_E = -100\mu\text{A}$
Collector Cut-Off Current	$I_{CBO}$			-100	nA	$V_{CB} = -16\text{V}$
Emitter Cut-Off Current	$I_{EBO}$			-100	nA	$V_{EB} = -6\text{V}$
Collector Emitter Cut-Off Current	$I_{CES}$			-100	nA	$V_{CES} = -16\text{V}$
Collector-Emitter Saturation Voltage	$V_{CE(sat)}$		-8 -65 -195 -140	-11 -85 -270 -190	mV mV mV mV	$I_C = -0.1\text{A}, I_B = -10\text{mA}^*$ $I_C = -1\text{A}, I_B = 20\text{mA}^*$ $I_C = -3\text{A}, I_B = -30\text{mA}^*$ $I_C = -3\text{A}, I_B = -150\text{mA}^*$
Base-Emitter Saturation Voltage	$V_{BE(sat)}$		-0.88	-0.95	V	$I_C = -3\text{A}, I_B = -30\text{mA}^*$
Base-Emitter Turn-On Voltage	$V_{BE(on)}$		-0.84	-0.90	V	$I_C = -3\text{A}, V_{CE} = -2\text{V}^*$
Static Forward Current Transfer Ratio	$h_{FE}$	300 300 200 20	450 450 300 40	900		$I_C = -10\text{mA}, V_{CE} = -2\text{V}^*$ $I_C = -1\text{A}, V_{CE} = -2\text{V}^*$ $I_C = -3\text{A}, V_{CE} = -2\text{V}^*$ $I_C = -12\text{A}, V_{CE} = -2\text{V}^*$
Transition Frequency	$f_T$		85		MHz	$I_C = -50\text{mA}, V_{CE} = -10\text{V}$ $f = 50\text{MHz}$
Output Capacitance	$C_{obo}$		75		pF	$V_{CB} = -10\text{V}, f = 1\text{MHz}$
Turn-On Time	$t_{(on)}$		100		ns	$V_{CC} = -10\text{V}, I_C = -3\text{A}$ $I_{B1} = I_{B2} = -60\text{mA}$
Turn-Off Time	$t_{(off)}$		1710		ns	

\*Measured under pulsed conditions. Pulse width=300 $\mu\text{s}$ . Duty cycle  $\leq 2\%$

# ZXT12P12DX

## TYPICAL CHARACTERISTICS

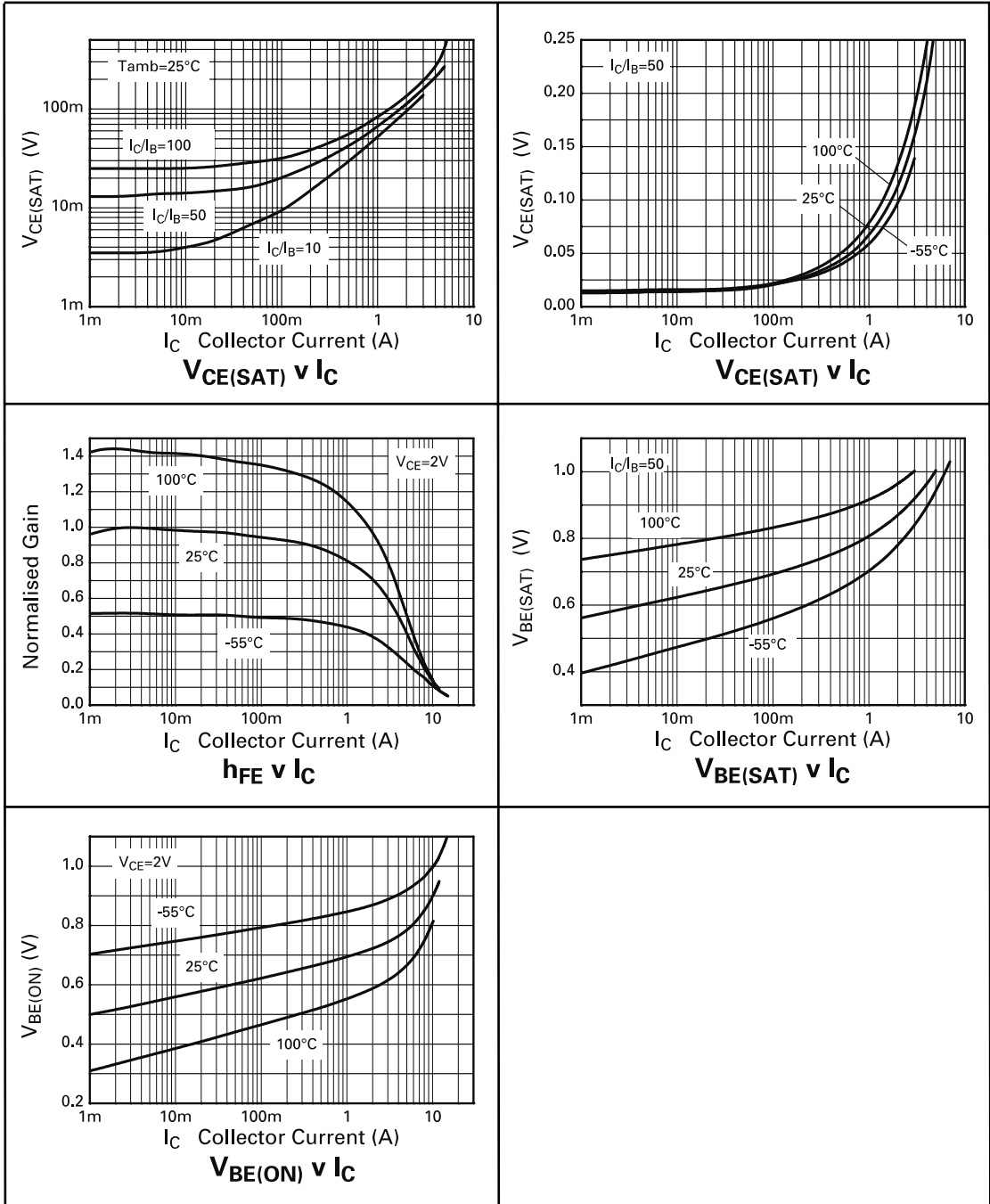

# ZXT12P12DX

## PACKAGE DIMENSIONS

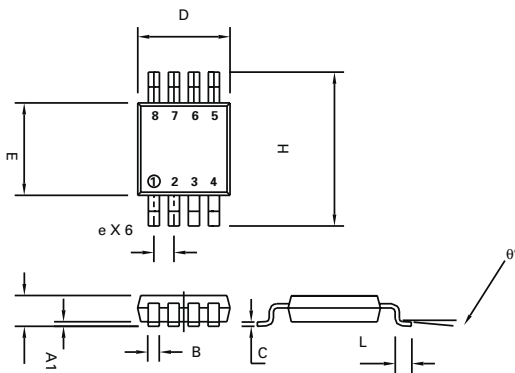

Conforms to JEDEC MO-187 Iss A

## PAD LAYOUT DETAILS

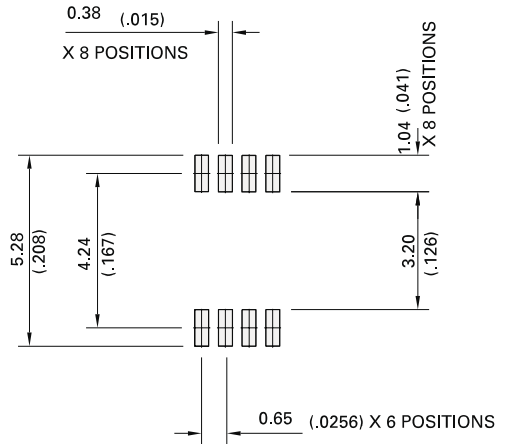

DIM	Millimetres		Inches	
	MIN	MAX	MIN	MAX
A		1.10		0.043
A1	0.05	0.15	0.002	0.006
B	0.25	0.40	0.010	0.016
C	0.13	0.23	0.005	0.009
D	2.90	3.10	0.114	0.122
e	0.65	BSC	0.0256	BSC
E	2.90	3.10	0.114	0.122
H	4.90	BSC	0.193	BSC
L	0.40	0.70	0.016	0.028
q°	0°	6°	0°	6°



Zetex plc.  
Fields New Road, Chadderton, Oldham, OL9-8NP, United Kingdom.  
Telephone: (44)161 622 4422 (Sales), (44)161 622 4444 (General Enquiries)  
Fax: (44)161 622 4420

Zetex GmbH  
Streitfeldstraße 19  
D-81673 München  
Germany  
Telefon: (49) 89 45 49 49 0  
Fax: (49) 89 45 49 49 49

Zetex Inc.  
47 Mall Drive, Unit 4  
Commack NY 11725  
USA  
Telephone: (631) 543-7100  
Fax: (631) 864-7630

Zetex (Asia) Ltd.  
3510 Metroplaza, Tower 2  
Hing Fong Road,  
Kwai Fong, Hong Kong  
Telephone: (852) 26100 611  
Fax: (852) 24250 494

These are supported by  
agents and distributors in  
major countries world-wide  
© Zetex plc 2000

Internet <http://www.zetex.com>

This publication is issued to provide outline information only which (unless agreed by the Company in writing) may not be used, applied or reproduced for any purpose or form part of any order or contract or be regarded as a representation relating to the products or services concerned. The Company reserves the right to alter without notice the specification, design, price or conditions of supply of any product or service.



Компания «ЭлектроПласт» предлагает заключение долгосрочных отношений при поставках импортных электронных компонентов на взаимовыгодных условиях!

Наши преимущества:

- Оперативные поставки широкого спектра электронных компонентов отечественного и импортного производства напрямую от производителей и с крупнейших мировых складов;
- Поставка более 17-ти миллионов наименований электронных компонентов;
- Поставка сложных, дефицитных, либо снятых с производства позиций;
- Оперативные сроки поставки под заказ (от 5 рабочих дней);
- Экспресс доставка в любую точку России;
- Техническая поддержка проекта, помощь в подборе аналогов, поставка прототипов;
- Система менеджмента качества сертифицирована по Международному стандарту ISO 9001;
- Лицензия ФСБ на осуществление работ с использованием сведений, составляющих государственную тайну;
- Поставка специализированных компонентов (Xilinx, Altera, Analog Devices, Intersil, Interpoint, Microsemi, Aeroflex, Peregrine, Syfer, Eurofarad, Texas Instrument, Miteq, Cobham, E2V, MA-COM, Hittite, Mini-Circuits, General Dynamics и др.);

Помимо этого, одним из направлений компании «ЭлектроПласт» является направление «Источники питания». Мы предлагаем Вам помощь Конструкторского отдела:

- Подбор оптимального решения, техническое обоснование при выборе компонента;
- Подбор аналогов;
- Консультации по применению компонента;
- Поставка образцов и прототипов;
- Техническая поддержка проекта;
- Защита от снятия компонента с производства.



#### Как с нами связаться

**Телефон:** 8 (812) 309 58 32 (многоканальный)

**Факс:** 8 (812) 320-02-42

**Электронная почта:** [org@eplast1.ru](mailto:org@eplast1.ru)

**Адрес:** 198099, г. Санкт-Петербург, ул. Калинина, дом 2, корпус 4, литера А.