

## FEATURES

- 4-Channel Simultaneous Sampling ADC
- 70.6dB SNR
- 88dB SFDR
- Low Power: 545mW/439mW/369mW Total, 136mW/110mW/92mW per Channel
- Single 1.8V Supply
- Serial LVDS Outputs: 1 or 2 Bits per Channel
- Selectable Input Ranges: 1V<sub>P-P</sub> to 2V<sub>P-P</sub>
- 800MHz Full Power Bandwidth S/H
- Shutdown and Nap Modes
- Serial SPI Port for Configuration
- Pin Compatible 14-Bit and 12-Bit Versions
- 52-Pin (7mm × 8mm) QFN Package

## APPLICATIONS

- Communications
- Cellular Base Stations
- Software Defined Radios
- Portable Medical Imaging
- Multichannel Data Acquisition
- Nondestructive Testing

LT, LT, LTC, LTM, Linear Technology and the Linear logo are registered trademarks of Linear Technology Corporation. All other trademarks are the property of their respective owners.

## DESCRIPTION

The LTC<sup>®</sup>2175-12/LTC2174-12/LTC2173-12 are 4-channel, simultaneous sampling 12-bit A/D converters designed for digitizing high frequency, wide dynamic range signals. They are perfect for demanding communications applications with AC performance that includes 70.6dB SNR and 88dB spurious free dynamic range (SFDR). Ultralow jitter of 0.15ps<sub>RMS</sub> allows undersampling of IF frequencies with excellent noise performance.

DC specs include ±0.3LSB INL (typ), ±0.1LSB DNL (typ) and no missing codes over temperature. The transition noise is a low 0.3LSB<sub>RMS</sub>.

The digital outputs are serial LVDS to minimize the number of data lines. Each channel outputs two bits at a time (2-lane mode). At lower sampling rates there is a one bit per channel option (1-lane mode). The LVDS drivers have optional internal termination and adjustable output levels to ensure clean signal integrity.

The ENC<sup>+</sup> and ENC<sup>-</sup> inputs may be driven differentially or single-ended with a sine wave, PECL, LVDS, TTL, or CMOS inputs. An internal clock duty cycle stabilizer allows high performance at full speed for a wide range of clock duty cycles.

## TYPICAL APPLICATION

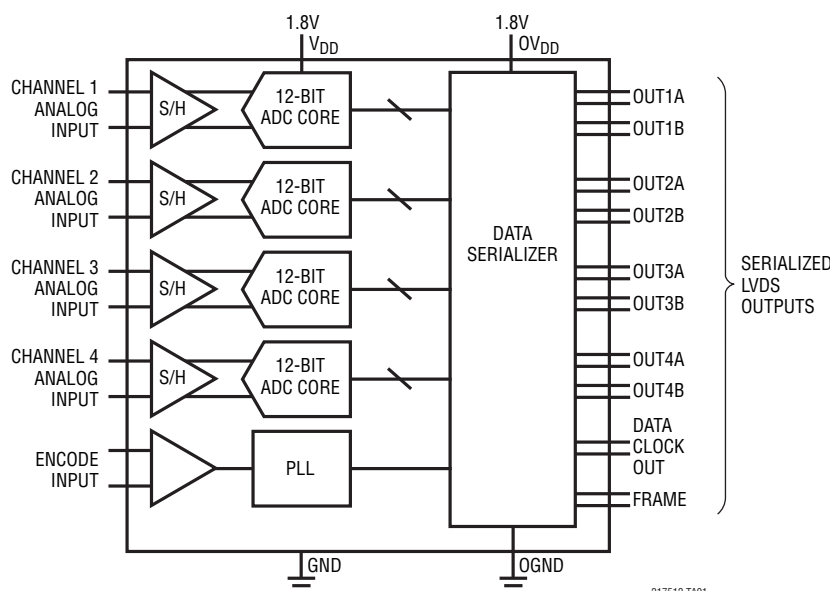

LTC2175-12, 125MSPS,  
 2-Tone FFT,  $f_{IN} = 70\text{MHz}$  and  $75\text{MHz}$

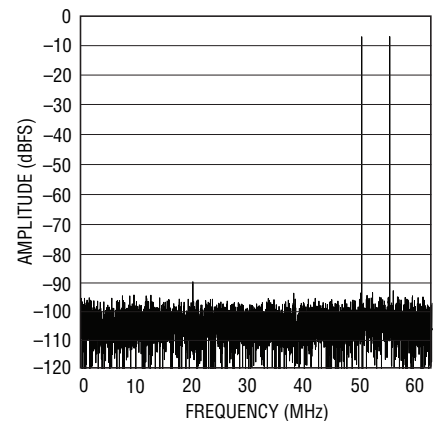

217512 TAO1b

217512 TAO1

21754312fa

# LTC2175-12/ LTC2174-12/LTC2173-12

## ABSOLUTE MAXIMUM RATINGS

(Notes 1, 2)

Supply Voltages

$V_{DD}$ ,  $OV_{DD}$ ..... -0.3V to 2V

Analog Input Voltage ( $A_{IN}^+$ ,  $A_{IN}^-$ ,

$PAR/SER$ ,  $SENSE$ ) (Note 3)..... -0.3V to ( $V_{DD} + 0.2V$ )

Digital Input Voltage ( $ENC^+$ ,  $ENC^-$ ,  $\overline{CS}$ ,

$SDI$ ,  $SCK$ ) (Note 4)..... -0.3V to 3.9V

$SDO$  (Note 4)..... -0.3V to 3.9V

Digital Output Voltage..... -0.3V to ( $OV_{DD} + 0.3V$ )

Operating Temperature Range

LTC2175C, 2174C, 2173C..... 0°C to 70°C

LTC2175I, 2174I, 2173I..... -40°C to 85°C

Storage Temperature Range..... -65°C to 150°C

## PIN CONFIGURATIONS

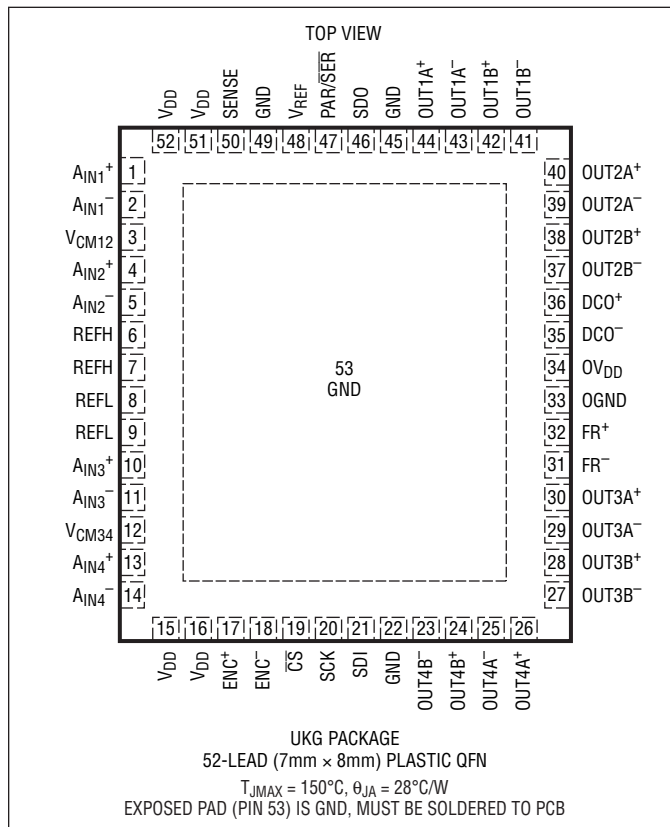

## ORDER INFORMATION

LEAD FREE FINISH	TAPE AND REEL	PART MARKING*	PACKAGE DESCRIPTION	TEMPERATURE RANGE
LTC2175CUKG-12#PBF	LTC2175CUKG-12#TRPBF	LTC2175UKG-12	52-Lead (7mm × 8mm) Plastic QFN	0°C to 70°C
LTC2175IUKG-12#PBF	LTC2175IUKG-12#TRPBF	LTC2175UKG-12	52-Lead (7mm × 8mm) Plastic QFN	-40°C to 85°C
LTC2174CUKG-12#PBF	LTC2174CUKG-12#TRPBF	LTC2174UKG-12	52-Lead (7mm × 8mm) Plastic QFN	0°C to 70°C
LTC2174IUKG-12#PBF	LTC2174IUKG-12#TRPBF	LTC2174UKG-12	52-Lead (7mm × 8mm) Plastic QFN	-40°C to 85°C
LTC2173CUKG-12#PBF	LTC2173CUKG-12#TRPBF	LTC2173UKG-12	52-Lead (7mm × 8mm) Plastic QFN	0°C to 70°C
LTC2173IUKG-12#PBF	LTC2173IUKG-12#TRPBF	LTC2173UKG-12	52-Lead (7mm × 8mm) Plastic QFN	-40°C to 85°C

Consult LTC Marketing for parts specified with wider operating temperature ranges. \*The temperature grade is identified by a label on the shipping container. Consult LTC Marketing for information on non-standard lead based finish parts.

For more information on lead free part marking, go to: <http://www.linear.com/leadfree/>

For more information on tape and reel specifications, go to: <http://www.linear.com/tapeandreeel/>

**CONVERTER CHARACTERISTICS** The ● denotes the specifications which apply over the full operating temperature range, otherwise specifications are at  $T_A = 25^\circ\text{C}$ . (Note 5)

PARAMETER	CONDITIONS	LTC2175-12			LTC2174-12			LTC2173-12			UNITS	
		MIN	TYP	MAX	MIN	TYP	MAX	MIN	TYP	MAX		
Resolution (No Missing Codes)		●	12		12		12		12		Bits	
Integral Linearity Error	Differential Analog Input (Note 6)	●	-1	±0.3	1	-1	±0.3	1	-1	±0.3	1	LSB
Differential Linearity Error	Differential Analog Input	●	-0.4	±0.1	0.4	-0.4	±0.1	0.4	-0.4	±0.1	0.4	LSB
Offset Error	(Note 7)	●	-12	±3	12	-12	±3	12	-12	±3	12	mV
Gain Error	Internal Reference External Reference	●	-2.8	-1.3	0.2	-2.8	-1.3	0.2	-2.8	-1.3	0.2	%FS %FS
Offset Drift				±20			±20			±20		$\mu\text{V}/^\circ\text{C}$
Full-Scale Drift	Internal Reference External Reference			±35 ±25			±35 ±25			±35 ±25		ppm/ $^\circ\text{C}$ ppm/ $^\circ\text{C}$
Gain Matching	External Reference			±0.2			±0.2			±0.2		%FS
Offset Matching				±3			±3			±3		mV
Transition Noise	External Reference			0.3			0.3			0.3		$\text{LSB}_{\text{RMS}}$

**ANALOG INPUT** The ● denotes the specifications which apply over the full operating temperature range, otherwise specifications are at  $T_A = 25^\circ\text{C}$ . (Note 5)

SYMBOL	PARAMETER	CONDITIONS	MIN	TYP	MAX	UNITS
$V_{\text{IN}}$	Analog Input Range ( $A_{\text{IN}}^+ - A_{\text{IN}}^-$ )	$1.7\text{V} < V_{\text{DD}} < 1.9\text{V}$	●	1 to 2		$V_{\text{P-P}}$
$V_{\text{IN(CM)}}$	Analog Input Common Mode ( $A_{\text{IN}}^+ + A_{\text{IN}}^-$ )/2	Differential Analog Input (Note 8)	●	$V_{\text{CM}} - 100\text{mV}$	$V_{\text{CM}}$ $V_{\text{CM}} + 100\text{mV}$	V
$V_{\text{SENSE}}$	External Voltage Reference Applied to SENSE	External Reference Mode	●	0.625	1.250 1.300	V
$I_{\text{INCM}}$	Analog Input Common Mode Current	Per Pin, 125Msps Per Pin, 105Msps Per Pin, 80Msps		155 130 100		$\mu\text{A}$ $\mu\text{A}$ $\mu\text{A}$
$I_{\text{IN1}}$	Analog Input Leakage Current No Encode	$0 < A_{\text{IN}}^+, A_{\text{IN}}^- < V_{\text{DD}}$	●	-1	1	$\mu\text{A}$
$I_{\text{IN2}}$	PAR/SER Input Leakage Current	$0 < \text{PAR}/\text{SER} < V_{\text{DD}}$	●	-3	3	$\mu\text{A}$
$I_{\text{IN3}}$	SENSE Input Leakage Current	$0.625 < \text{SENSE} < 1.3\text{V}$	●	-6	6	$\mu\text{A}$
$t_{\text{AP}}$	Sample-and-Hold Acquisition Delay Time			0		ns
$t_{\text{JITTER}}$	Sample-and-Hold Acquisition Delay Jitter			0.15		$\text{pS}_{\text{RMS}}$
CMRR	Analog Input Common Mode Rejection Ratio			80		dB
BW-3B	Full-Power Bandwidth	Figure 6 Test Circuit		800		MHz

# LTC2175-12/ LTC2174-12/LTC2173-12

**DYNAMIC ACCURACY** The ● denotes the specifications which apply over the full operating temperature range, otherwise specifications are at  $T_A = 25^\circ\text{C}$ .  $A_{IN} = -1\text{dBFS}$ . (Note 5)

SYMBOL	PARAMETER	CONDITIONS	LTC2175-12			LTC2174-12			LTC2173-12			UNITS
			MIN	TYP	MAX	MIN	TYP	MAX	MIN	TYP	MAX	
SNR	Signal-to-Noise Ratio	5MHz Input		70.6			70.6			70.6		dBFS
		70MHz Input	●	70.6			70.5			70.5		dBFS
		140MHz Input		70.3			70.3			70.3		dBFS
SFDR	Spurious Free Dynamic Range 2nd or 3rd Harmonic	5MHz Input		88			88			88		dBFS
		70MHz Input	●	85			85			85		dBFS
		140MHz Input		82			82			82		dBFS
	Spurious Free Dynamic Range 4th Harmonic or Higher	5MHz Input		90			90			90		dBFS
		70MHz Input	●	90			90			90		dBFS
		140MHz Input		90			90			90		dBFS
S/(N+D)	Signal-to-Noise Plus Distortion Ratio	5MHz Input		70.6			70.6			70.6		dBFS
		70MHz Input	●	70.4			70.4			70.4		dBFS
		140MHz Input		70			70			70		dBFS
	Crosstalk, Near Channel	10MHz Input (Note 12)		-90			-90			-90		dBc
	Crosstalk, Far Channel	10MHz Input (Note 12)		-105			-105			-105		dBc

**INTERNAL REFERENCE CHARACTERISTICS** The ● denotes the specifications which apply over the full operating temperature range, otherwise specifications are at  $T_A = 25^\circ\text{C}$ .  $A_{IN} = -1\text{dBFS}$ . (Note 5)

PARAMETER	CONDITIONS	MIN	TYP	MAX	UNITS
$V_{CM}$ Output Voltage	$I_{OUT} = 0$	$0.5 \cdot V_{DD} - 25\text{mV}$	$0.5 \cdot V_{DD}$	$0.5 \cdot V_{DD} + 25\text{mV}$	V
$V_{CM}$ Output Temperature Drift			$\pm 25$		ppm/ $^\circ\text{C}$
$V_{CM}$ Output Resistance	$-600\mu\text{A} < I_{OUT} < 1\text{mA}$		4		$\Omega$
$V_{REF}$ Output Voltage	$I_{OUT} = 0$	1.225	1.250	1.275	V
$V_{REF}$ Output Temperature Drift			$\pm 25$		ppm/ $^\circ\text{C}$
$V_{REF}$ Output Resistance	$-400\mu\text{A} < I_{OUT} < 1\text{mA}$		7		$\Omega$
$V_{REF}$ Line Regulation	$1.7\text{V} < V_{DD} < 1.9\text{V}$		0.6		mV/V

**DIGITAL INPUTS AND OUTPUTS** The ● denotes the specifications which apply over the full operating temperature range, otherwise specifications are at  $T_A = 25^\circ\text{C}$ . (Note 5)

SYMBOL	PARAMETER	CONDITIONS		MIN	TYP	MAX	UNITS
<b>ENCODE INPUTS (ENC<sup>+</sup>, ENC<sup>-</sup>)</b>							
<b>Differential Encode Mode (ENC<sup>-</sup> Not Tied to GND)</b>							
V <sub>ID</sub>	Differential Input Voltage	(Note 8)	●	0.2			V
V <sub>ICM</sub>	Common Mode Input Voltage	Internally Set Externally Set (Note 8)	●	1.1	1.2	1.6	V V
V <sub>IN</sub>	Input Voltage Range	ENC <sup>+</sup> , ENC <sup>-</sup> to GND	●	0.2		3.6	V
R <sub>IN</sub>	Input Resistance	(See Figure 10)			10		kΩ
C <sub>IN</sub>	Input Capacitance				3.5		pF
<b>Single-Ended Encode Mode (ENC<sup>-</sup> Tied to GND)</b>							
V <sub>IH</sub>	High Level Input Voltage	V <sub>DD</sub> = 1.8V	●	1.2			V
V <sub>IL</sub>	Low Level Input Voltage	V <sub>DD</sub> = 1.8V	●			0.6	V
V <sub>IN</sub>	Input Voltage Range	ENC <sup>+</sup> to GND	●	0		3.6	V
R <sub>IN</sub>	Input Resistance	(See Figure 11)			30		kΩ
C <sub>IN</sub>	Input Capacitance				3.5		pF
<b>DIGITAL INPUTS (CS, SDI, SCK in Serial or Parallel Programming Mode. SDO in Parallel Programming Mode)</b>							
V <sub>IH</sub>	High Level Input Voltage	V <sub>DD</sub> = 1.8V	●	1.3			V
V <sub>IL</sub>	Low Level Input Voltage	V <sub>DD</sub> = 1.8V	●			0.6	V
I <sub>IN</sub>	Input Current	V <sub>IN</sub> = 0V to 3.6V	●	-10		10	μA
C <sub>IN</sub>	Input Capacitance				3		pF
<b>SDO OUTPUT (Serial Programming Mode. Open-Drain Output. Requires 2kΩ Pull-Up Resistor if SDO is Used)</b>							
R <sub>OL</sub>	Logic Low Output Resistance to GND	V <sub>DD</sub> = 1.8V, SDO = 0V			200		Ω
I <sub>OH</sub>	Logic High Output Leakage Current	SDO = 0V to 3.6V	●	-10		10	μA
C <sub>OUT</sub>	Output Capacitance				3		pF
<b>DIGITAL DATA OUTPUTS</b>							
V <sub>OD</sub>	Differential Output Voltage	100Ω Differential Load, 3.5mA Mode 100Ω Differential Load, 1.75mA Mode	● ●	247 125	350 175	454 250	mV mV
V <sub>OS</sub>	Common Mode Output Voltage	100Ω Differential Load, 3.5mA Mode 100Ω Differential Load, 1.75mA Mode	● ●	1.125 1.125	1.250 1.250	1.375 1.375	V V
R <sub>TERM</sub>	On-Chip Termination Resistance	Termination Enabled, 0V <sub>DD</sub> = 1.8V			100		Ω

# LTC2175-12/ LTC2174-12/LTC2173-12

## POWER REQUIREMENTS

The ● denotes the specifications which apply over the full operating temperature range, otherwise specifications are at  $T_A = 25^\circ\text{C}$ . (Note 9)

SYMBOL	PARAMETER	CONDITIONS	LTC2175-12			LTC2174-12			LTC2173-12			UNITS	
			MIN	TYP	MAX	MIN	TYP	MAX	MIN	TYP	MAX		
$V_{DD}$	Analog Supply Voltage	(Note 10)	●	1.7	1.8	1.9	1.7	1.8	1.9	1.7	1.8	1.9	V
$OV_{DD}$	Output Supply Voltage	(Note 10)	●	1.7	1.8	1.9	1.7	1.8	1.9	1.7	1.8	1.9	V
$I_{VDD}$	Analog Supply Current	Sine Wave Input	●		276	300		218	240		180	196	mA
$I_{OVDD}$	Digital Supply Current	2-Lane Mode, 1.75mA Mode	●		27	31		26	31		25	29	mA
		2-Lane Mode, 3.5mA Mode	●		49	54		48	53		47	52	mA
$P_{DISS}$	Power Dissipation	2-Lane Mode, 1.75mA Mode	●		545	596		439	488		369	405	mW
		2-Lane Mode, 3.5mA Mode	●		585	637		479	527		409	446	mW
$P_{SLEEP}$	Sleep Mode Power				1			1			1		mW
$P_{NAP}$	Nap Mode Power				85			85			85		mW
$P_{DIFFCLK}$	Power Increase With Differential Encode Mode Enabled (No Increase for Sleep Mode)				20			20			20		mW

## TIMING CHARACTERISTICS

The ● denotes the specifications which apply over the full operating temperature range, otherwise specifications are at  $T_A = 25^\circ\text{C}$ . (Note 5)

SYMBOL	PARAMETER	CONDITIONS	LTC2175-12			LTC2174-12			LTC2173-12			UNITS	
			MIN	TYP	MAX	MIN	TYP	MAX	MIN	TYP	MAX		
$f_S$	Sampling Frequency	(Notes 10,11)	●	5		125	5		105	5		80	MHz
$t_{ENCL}$	ENC Low Time (Note 8)	Duty Cycle Stabilizer Off	●	3.8	4	100	4.52	4.76	100	5.93	6.25	100	ns
		Duty Cycle Stabilizer On	●	2	4	100	2	4.76	100	2	6.25	100	ns
$t_{ENCH}$	ENC High Time (Note 8)	Duty Cycle Stabilizer Off	●	3.8	4	100	4.52	4.76	100	5.93	6.25	100	ns
		Duty Cycle Stabilizer On	●	2	4	100	2	4.76	100	2	6.25	100	ns
$t_{AP}$	Sample-and-Hold Acquisition Delay Time				0			0			0		ns

SYMBOL	PARAMETER	CONDITIONS	MIN	TYP	MAX	UNITS	
<b>Digital Data Outputs (<math>R_{TERM} = 100\Omega</math> Differential, <math>C_L = 2\text{pF}</math> to GND on Each Output)</b>							
$t_{SER}$	Serial Data Bit Period	2-Lanes, 16-Bit Serialization			$1/(8 \cdot f_S)$	s	
		2-Lanes, 14-Bit Serialization			$1/(7 \cdot f_S)$	s	
		2-Lanes, 12-Bit Serialization			$1/(6 \cdot f_S)$	s	
		1-Lane, 16-Bit Serialization			$1/(16 \cdot f_S)$	s	
		1-Lane, 14-Bit Serialization			$1/(14 \cdot f_S)$	s	
		1-Lane, 12-Bit Serialization			$1/(12 \cdot f_S)$	s	
$t_{FRAME}$	FR to DCO Delay	(Note 8)	●	$0.35 \cdot t_{SER}$	$0.5 \cdot t_{SER}$	$0.65 \cdot t_{SER}$	s
$t_{DATA}$	DATA to DCO Delay	(Note 8)	●	$0.35 \cdot t_{SER}$	$0.5 \cdot t_{SER}$	$0.65 \cdot t_{SER}$	s
$t_{PD}$	Propagation Delay	(Note 8)	●	$0.7n + 2 \cdot t_{SER}$	$1.1n + 2 \cdot t_{SER}$	$1.5n + 2 \cdot t_{SER}$	s
$t_R$	Output Rise Time	Data, DCO, FR, 20% to 80%			0.17	ns	
$t_F$	Output Fall Time	Data, DCO, FR, 20% to 80%			0.17	ns	
	DCO Cycle-Cycle Jitter	$t_{SER} = 1\text{ns}$			60	pSp-P	
	Pipeline Latency				6	Cycles	

**TIMING CHARACTERISTICS** The ● denotes the specifications which apply over the full operating temperature range, otherwise specifications are at  $T_A = 25^\circ\text{C}$ . (Note 5)

SYMBOL	PARAMETER	CONDITIONS		MIN	TYP	MAX	UNITS
<b>SPI Port Timing (Note 8)</b>							
$t_{\text{SCK}}$	SCK Period	Write Mode Readback Mode, $C_{\text{SDO}} = 20\text{pF}$ , $R_{\text{PULLUP}} = 2\text{k}$	● ●	40 250			ns ns
$t_{\text{S}}$	$\overline{\text{CS}}$ to SCK Setup Time		●	5			ns
$t_{\text{H}}$	SCK to $\overline{\text{CS}}$ Setup Time		●	5			ns
$t_{\text{DS}}$	SDI Setup Time		●	5			ns
$t_{\text{DH}}$	SDI Hold Time		●	5			ns
$t_{\text{DO}}$	SCK Falling to SDO Valid	Readback Mode, $C_{\text{SDO}} = 20\text{pF}$ , $R_{\text{PULLUP}} = 2\text{k}$	●			125	ns

**Note 1:** Stresses beyond those listed under Absolute Maximum Ratings may cause permanent damage to the device. Exposure to any Absolute Maximum Rating condition for extended periods may affect device reliability and lifetime.

**Note 2:** All voltage values are with respect to GND with GND and OGND shorted (unless otherwise noted).

**Note 3:** When these pin voltages are taken below GND or above  $V_{\text{DD}}$ , they will be clamped by internal diodes. This product can handle input currents of greater than 100mA below GND or above  $V_{\text{DD}}$  without latchup.

**Note 4:** When these pin voltages are taken below GND they will be clamped by internal diodes. When these pin voltages are taken above  $V_{\text{DD}}$  they will not be clamped by internal diodes. This product can handle input currents of greater than 100mA below GND without latchup.

**Note 5:**  $V_{\text{DD}} = \text{OV}_{\text{DD}} = 1.8\text{V}$ ,  $f_{\text{SAMPLE}} = 125\text{MHz}$  (LTC2175), 105MHz (LTC2174), or 80MHz (LTC2173), 2-lane output mode, differential  $\text{ENC}^+$ / $\text{ENC}^- = 2V_{\text{P-P}}$  sine wave, input range =  $2V_{\text{P-P}}$  with differential drive, unless otherwise noted.

**Note 6:** Integral nonlinearity is defined as the deviation of a code from a best fit straight line to the transfer curve. The deviation is measured from the center of the quantization band.

**Note 7:** Offset error is the offset voltage measured from  $-0.5$  LSB when the output code flickers between 0000 0000 0000 and 1111 1111 1111 in 2's complement output mode.

**Note 8:** Guaranteed by design, not subject to test.

**Note 9:**  $V_{\text{DD}} = \text{OV}_{\text{DD}} = 1.8\text{V}$ ,  $f_{\text{SAMPLE}} = 125\text{MHz}$  (LTC2175), 105MHz (LTC2174), or 80MHz (LTC2173), 2-lane output mode,  $\text{ENC}^+ =$  single-ended 1.8V square wave,  $\text{ENC}^- = 0\text{V}$ , input range =  $2V_{\text{P-P}}$  with differential drive, unless otherwise noted. The supply current and power dissipation specifications are totals for the entire chip, not per channel.

**Note 10:** Recommended operating conditions.

**Note 11:** The maximum sampling frequency depends on the speed grade of the part and also which serialization mode is used. The maximum serial data rate is 1000Mbps so  $t_{\text{SER}}$  must be greater than or equal to 1ns.

**Note 12:** Near-channel crosstalk refers to Ch. 1 to Ch.2, and Ch.3 to Ch.4. Far-channel crosstalk refers to Ch.1 to Ch.3, Ch.1 to Ch.4, Ch.2 to Ch.3, and Ch.2 to Ch.4.

## TIMING DIAGRAMS

### 2-Lane Output Mode, 16-Bit Serialization

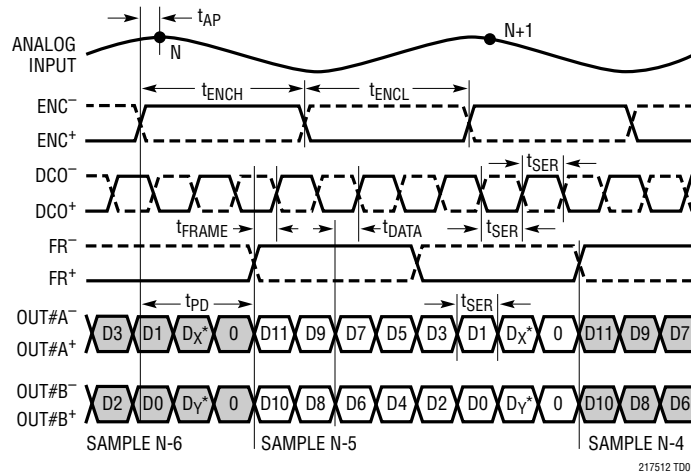

\* $D_x$  AND  $D_y$  ARE EXTRA NON-DATA BITS FOR COMPLETE SOFTWARE COMPATIBILITY WITH THE 14-BIT VERSIONS OF THESE A/Ds. DURING NORMAL NON-OVERRANGED OPERATION  $D_x$  AND  $D_y$  ARE SET TO LOGIC 0. SEE THE DATA FORMAT SECTION FOR MORE DETAILS.

### 2-Lane Output Mode, 14-Bit Serialization

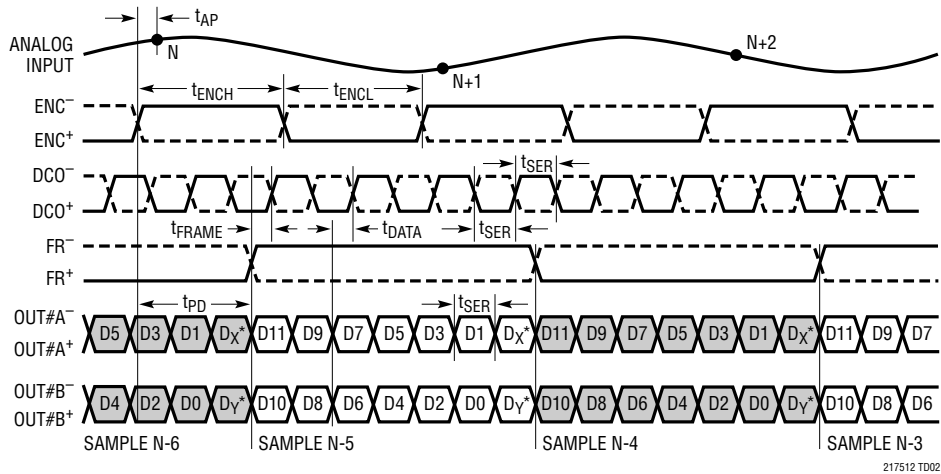

NOTE THAT IN THIS MODE  $FR^+/FR^-$  HAS TWO TIMES THE PERIOD OF  $ENC^+/ENC^-$

\* $D_x$  AND  $D_y$  ARE EXTRA NON-DATA BITS FOR COMPLETE SOFTWARE COMPATIBILITY WITH THE 14-BIT VERSIONS OF THESE A/Ds. DURING NORMAL NON-OVERRANGED OPERATION  $D_x$  AND  $D_y$  ARE SET TO LOGIC 0. SEE THE DATA FORMAT SECTION FOR MORE DETAILS.



## TIMING DIAGRAMS

### 2-Lane Output Mode, 12-Bit Serialization

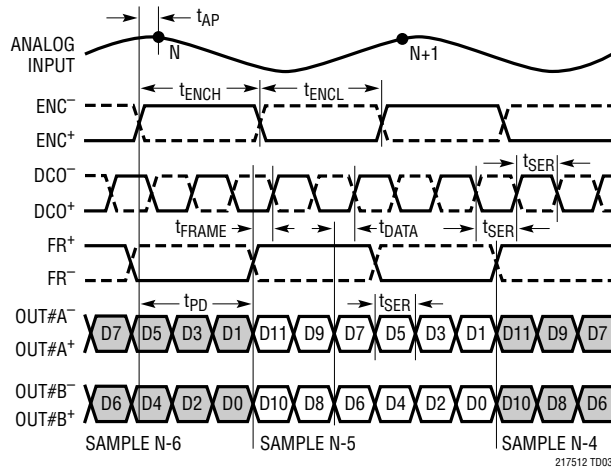

### 1-Lane Output Mode, 16-Bit Serialization

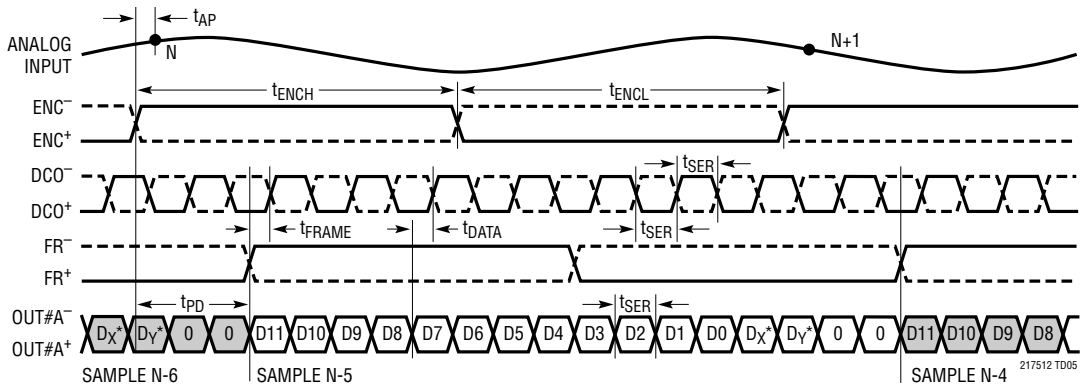

OUT#B<sup>+</sup>, OUT#B<sup>-</sup> ARE DISABLED

\*D<sub>x</sub> AND D<sub>y</sub> ARE EXTRA NON-DATA BITS FOR COMPLETE SOFTWARE COMPATIBILITY WITH THE 14-BIT VERSIONS OF THESE A/Ds. DURING NORMAL NON-OVERRANGED OPERATION D<sub>x</sub> AND D<sub>y</sub> ARE SET TO LOGIC 0. SEE THE DATA FORMAT SECTION FOR MORE DETAILS.

## TIMING DIAGRAMS

### One-Lane Output Mode, 14-Bit Serialization

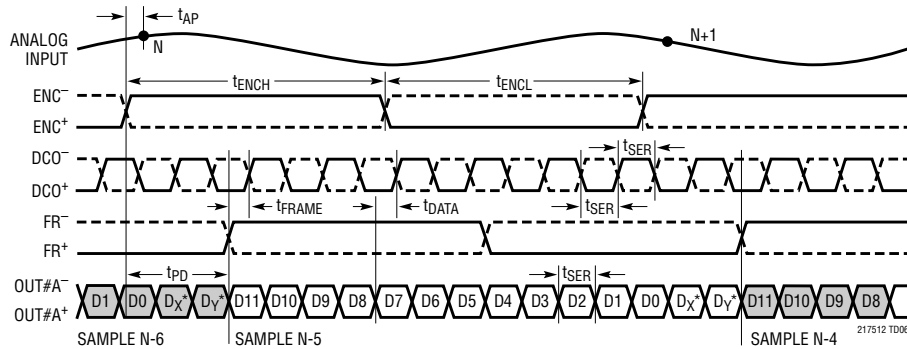

OUT#B<sup>+</sup>, OUT#B<sup>-</sup> ARE DISABLED

\*D<sub>x</sub> AND D<sub>y</sub> ARE EXTRA NON-DATA BITS FOR COMPLETE SOFTWARE COMPATIBILITY WITH THE 14-BIT VERSIONS OF THESE A/Ds. DURING NORMAL NON-OVERRANGED OPERATION D<sub>x</sub> AND D<sub>y</sub> ARE SET TO LOGIC 0. SEE THE DATA FORMAT SECTION FOR MORE DETAILS.

### One-Lane Output Mode, 12-Bit Serialization

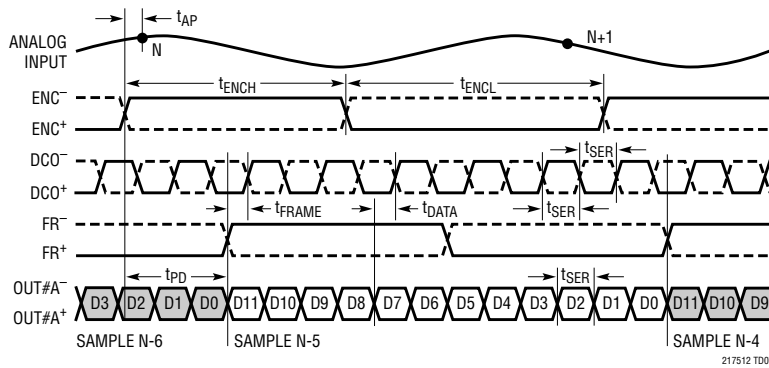

OUT#B<sup>+</sup>, OUT#B<sup>-</sup> ARE DISABLED

### SPI Port Timing (Readback Mode)

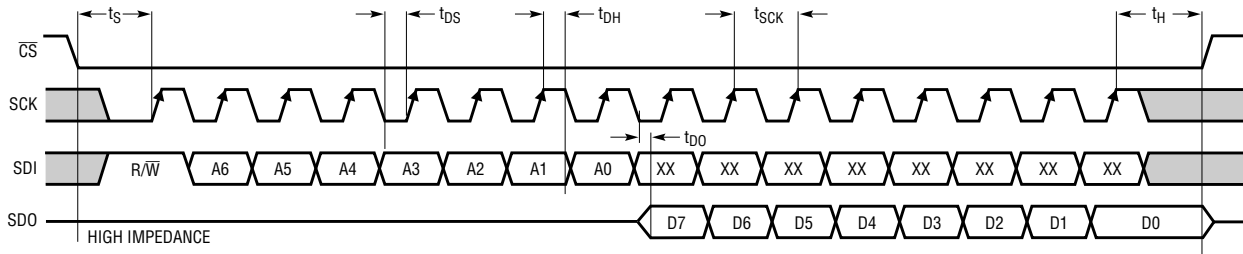

### SPI Port Timing (Write Mode)

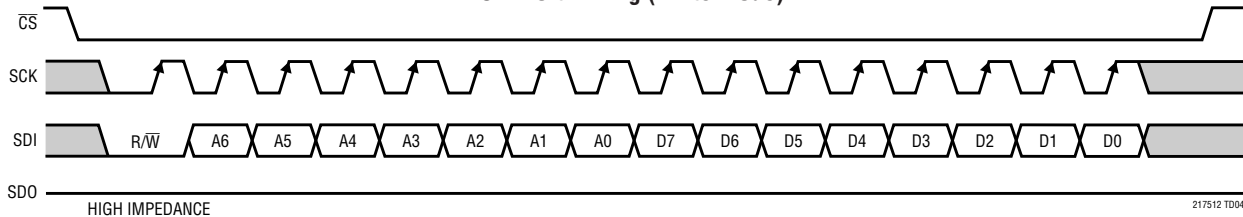

## TYPICAL PERFORMANCE CHARACTERISTICS

**LTC2175-12: Integral Nonlinearity (INL)**

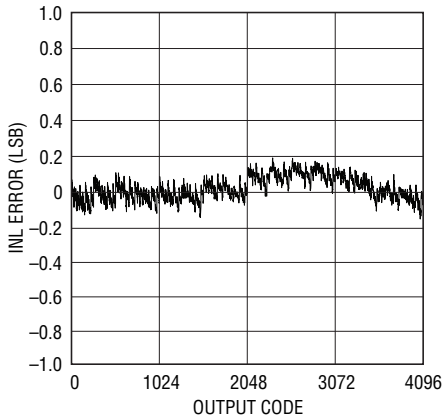

217512 G01

**LTC2175-12: Differential Nonlinearity (DNL)**

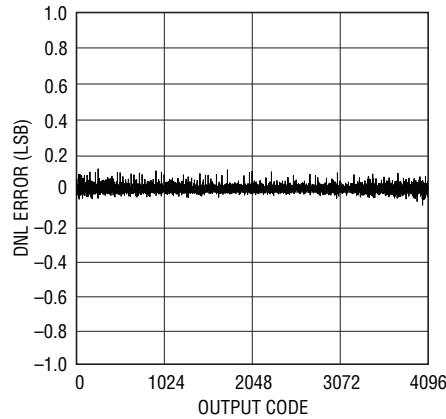

217512 G02

**LTC2175-12: 8k Point FFT,  $f_{IN} = 5\text{MHz}$ , -1dBFS, 125Msps**

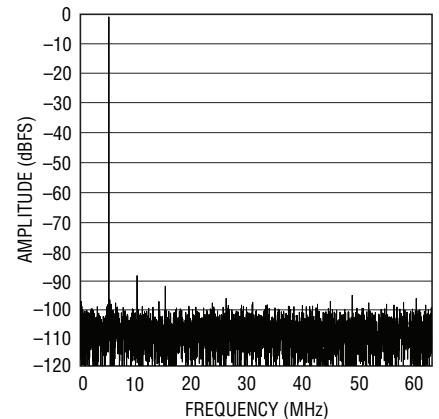

217512 G03

**LTC2175-12: 8k Point FFT,  $f_{IN} = 30\text{MHz}$ , -1dBFS, 125Msps**

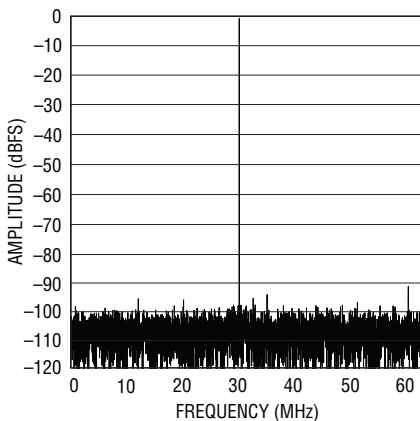

217512 G04

**LTC2175-12: 8k Point FFT,  $f_{IN} = 70\text{MHz}$ , -1dBFS, 125Msps**

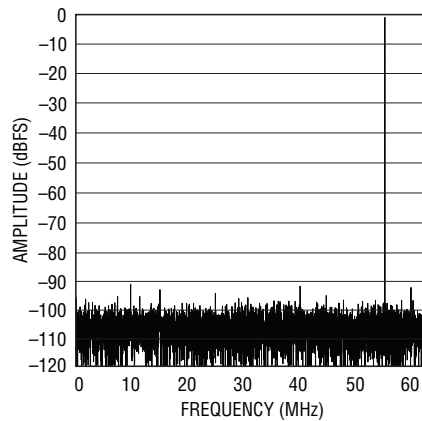

217512 G05

**LTC2175-12: 8k Point FFT,  $f_{IN} = 140\text{MHz}$ , -1dBFS, 125Msps**

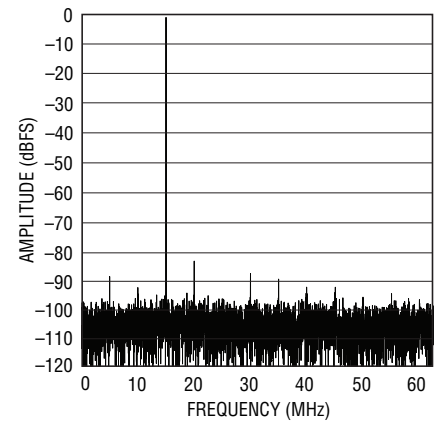

217512 G06

**LTC2175-12: 8k Point 2-Tone FFT,  $f_{IN} = 70\text{MHz}$ , 75MHz, -1dBFS, 125Msps**

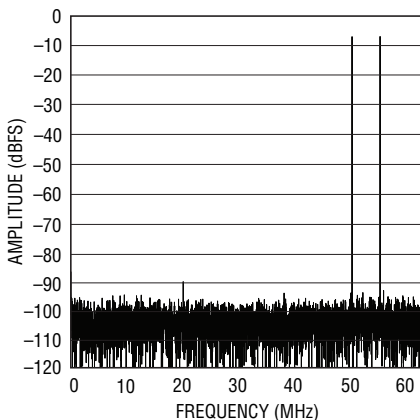

217512 G07

**LTC2175-12: Shorted Input Histogram**

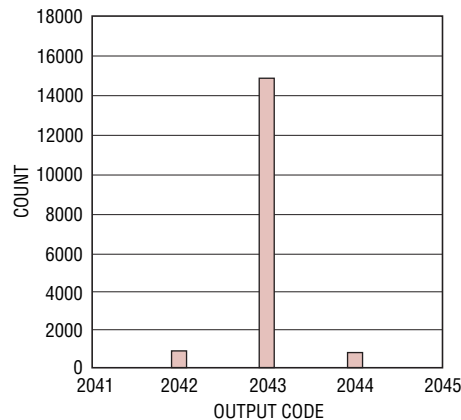

217512 G08

**LTC2175-12: SNR vs Input Frequency, -1dB, 2V Range, 125Msps**

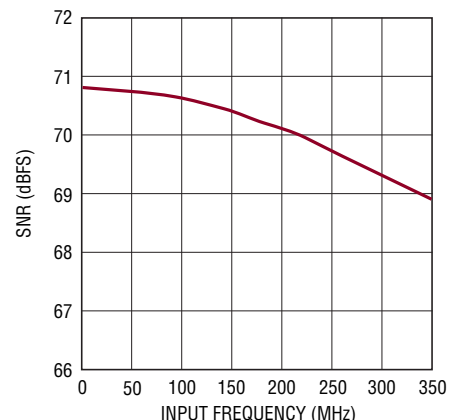

217512 G09

## TYPICAL PERFORMANCE CHARACTERISTICS

**LTC2175-12: SFDR vs Input Frequency, -1dB, 2V Range, 125Msps**

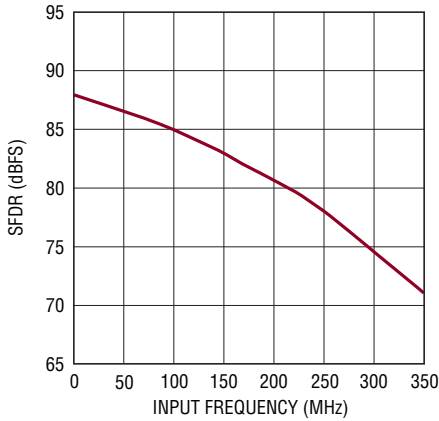

217512 G10

**LTC2175-12: SFDR vs Input Level,  $f_{IN} = 70\text{MHz}$ , 2V Range, 125Msps**

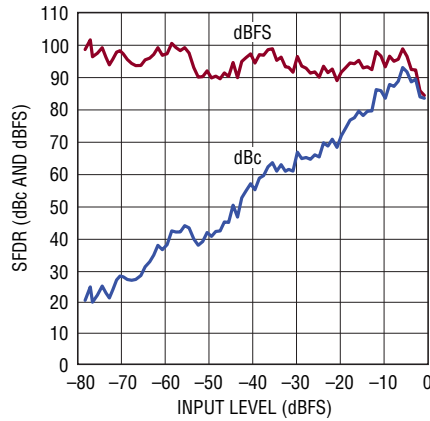

217512 G12

**LTC2175-12: SNR vs Input Level,  $f_{IN} = 70\text{MHz}$ , 2V Range, 125Msps**

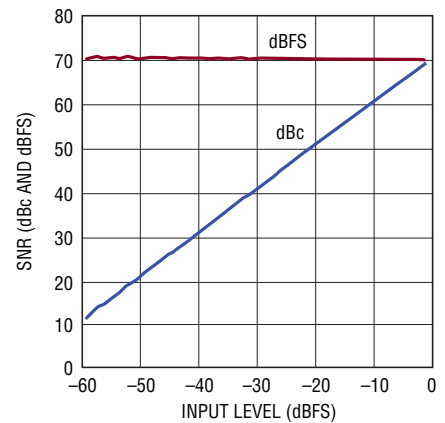

217512 G50

**LTC2175-12:  $I_{VDD}$  vs Sample Rate, 5MHz Sine Wave Input, -1dB**

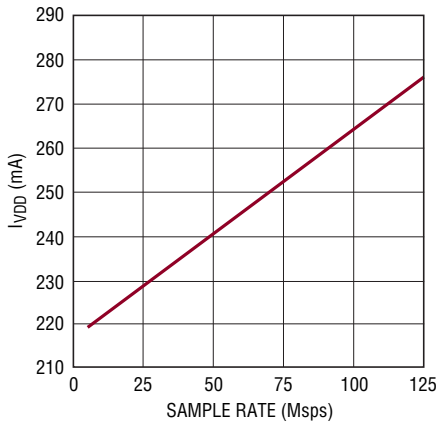

217512 G53

**$I_{O_{VDD}}$  vs Sample Rate, 5MHz Sine Wave Input, -1dB**

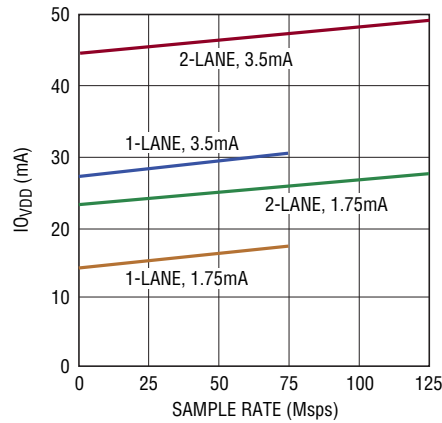

217512 G51

**LTC2175-12: SNR vs SENSE,  $f_{IN} = 5\text{MHz}$ , -1dB**

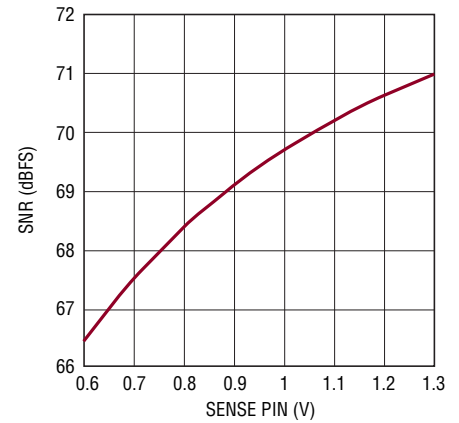

217512 G15

**LTC2174-12: Integral Nonlinearity (INL)**

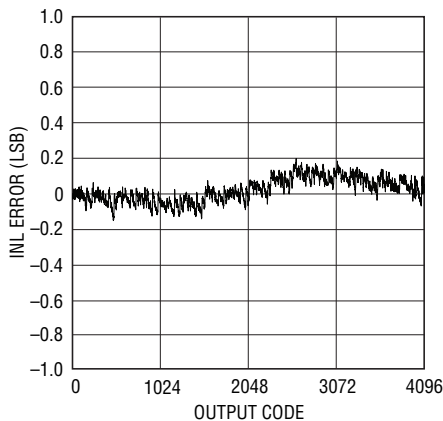

217512 G21

**LTC2174-12: Differential Nonlinearity (DNL)**

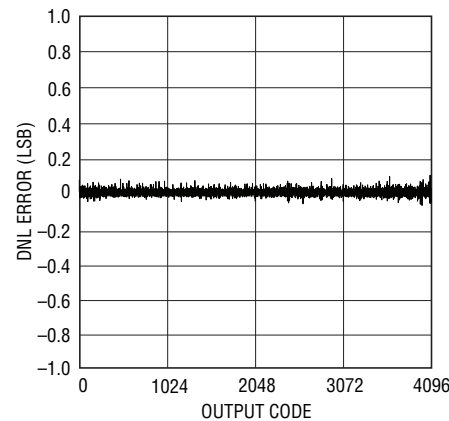

217512 G22

**LTC2174-12: 8k Point FFT,  $f_{IN} = 5\text{MHz}$ , -1dBFS, 105Msps**

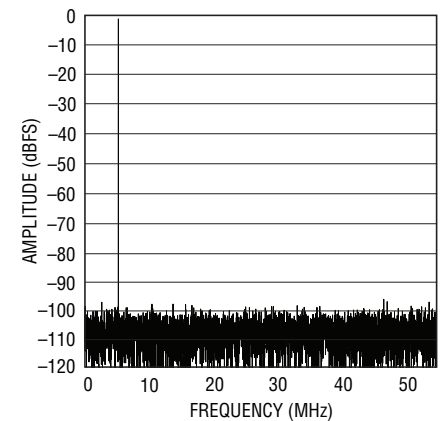

217512 G23

21754312fa

## TYPICAL PERFORMANCE CHARACTERISTICS

LTC2174-12: 8k Point FFT,  $f_{IN} = 30\text{MHz}$   
-1dBFS, 105Mps

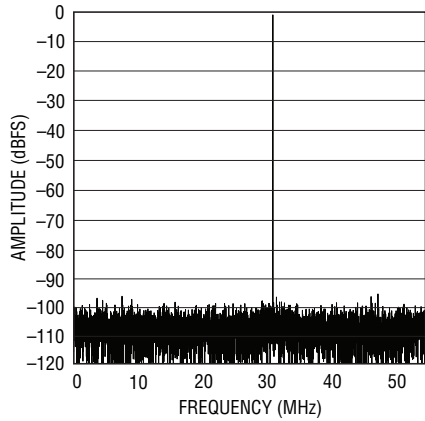

217512 G24

LTC2174-12: 8k Point FFT,  $f_{IN} = 70\text{MHz}$   
-1dBFS, 105Mps

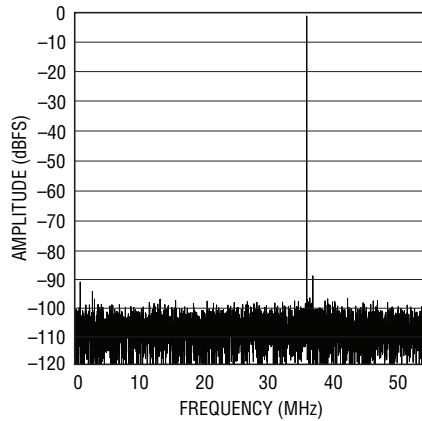

217512 G25

LTC2174-12: 8k Point FFT,  $f_{IN} = 140\text{MHz}$   
-1dBFS, 105Mps

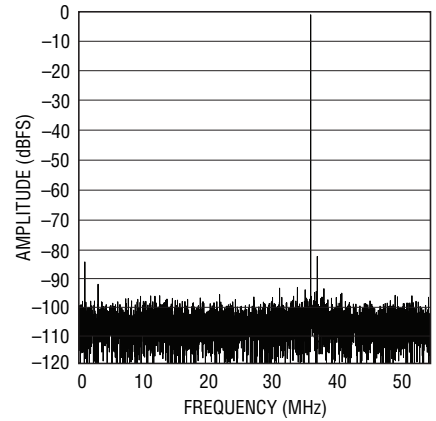

217512 G26

LTC2174-12: 8k Point 2-Tone FFT,  
 $f_{IN} = 70\text{MHz}, 75\text{MHz}, -1\text{dBFS},$   
105Mps

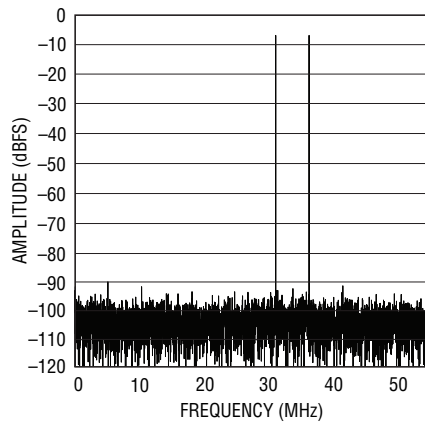

217512 G27

LTC2174-12: Shorted Input  
Histogram

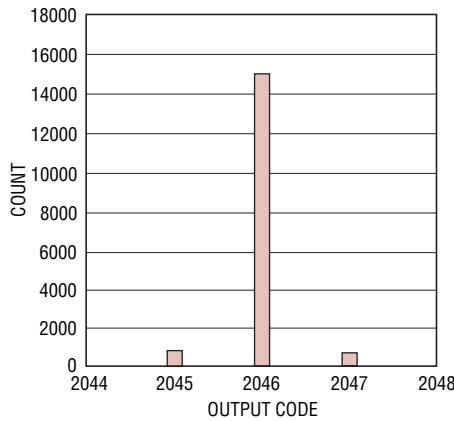

217512 G28

LTC2174-12: SNR vs Input  
Frequency, -1dB, 2V Range,  
105Mps

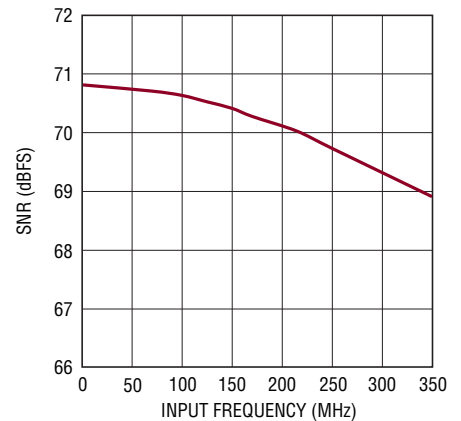

217512 G29

LTC2174-12: SFDR vs Input  
Frequency, -1dB, 2V Range,  
105Mps

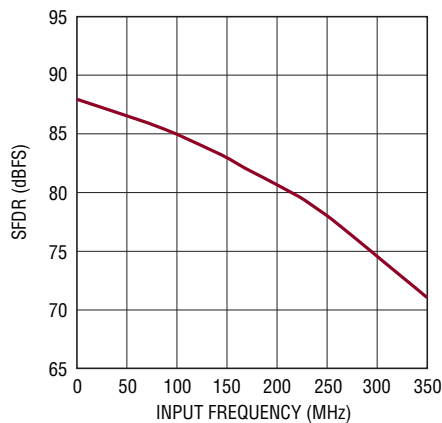

217512 G23a

LTC2174-12: SFDR vs Input Level,  
 $f_{IN} = 70\text{MHz}, 2\text{V Range}, 105\text{Mps}$

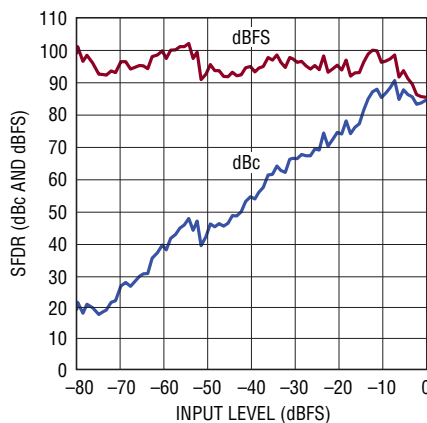

217512 G32

LTC2174-12:  $I_{VDD}$  vs Sample Rate,  
5MHz Sine Wave Input, -1dB

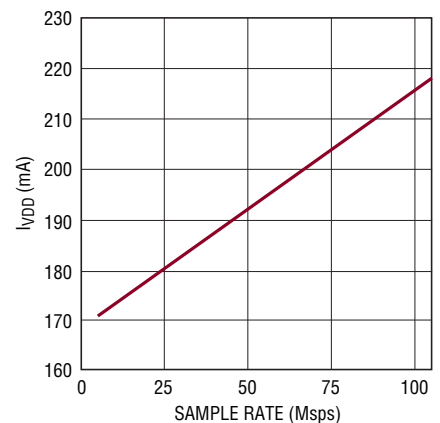

217512 G54

## TYPICAL PERFORMANCE CHARACTERISTICS

**LTC2174-12: SNR vs SENSE,**  
 $f_{IN} = 5\text{MHz}, -1\text{dB}$

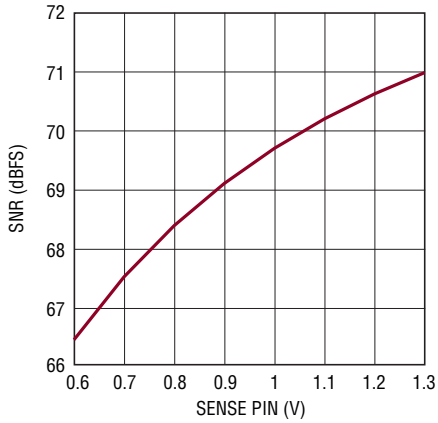

217512 G35

**LTC2173-12: Integral Nonlinearity (INL)**

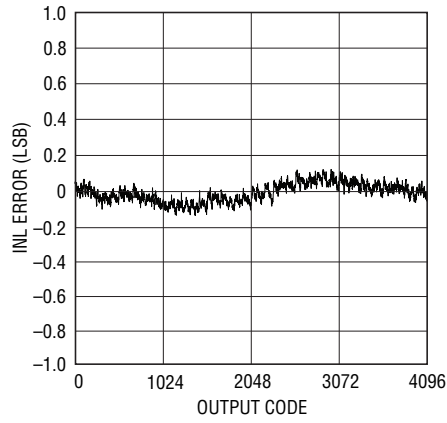

217512 G41

**LTC2173-12: Differential Nonlinearity (DNL)**

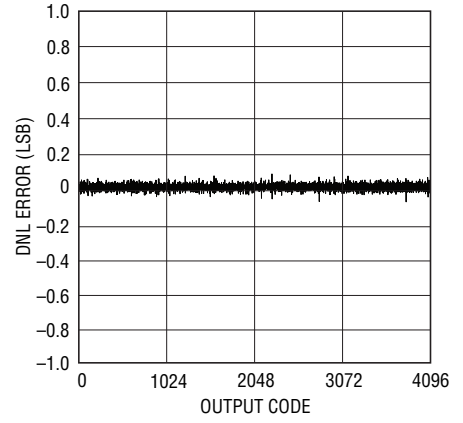

217512 G42

**LTC2173-12: 8k Point FFT,  $f_{IN} = 5\text{MHz}$**   
 $-1\text{dBFS}, 80\text{Mps}$

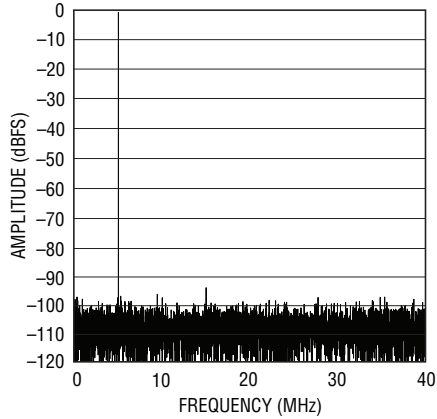

217512 G43

**LTC2173-12: 8k Point FFT,  $f_{IN} = 30\text{MHz}$**   
 $-1\text{dBFS}, 80\text{Mps}$

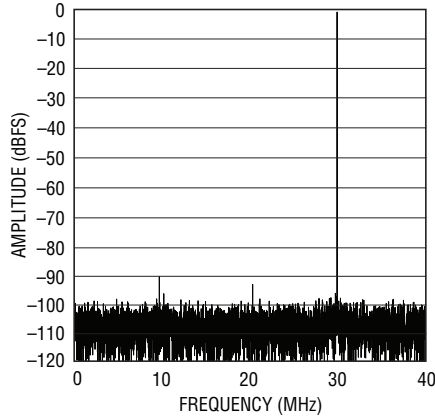

217512 G44

**LTC2173-12: 8k Point FFT,  $f_{IN} = 70\text{MHz}$**   
 $-1\text{dBFS}, 80\text{Mps}$

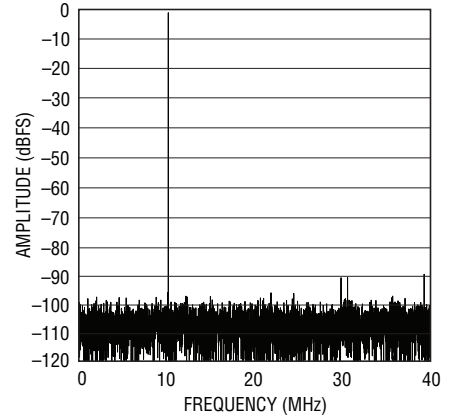

217512 G45

**LTC2173-12: 8k Point FFT,  $f_{IN} = 140\text{MHz}$**   
 $-1\text{dBFS}, 80\text{Mps}$

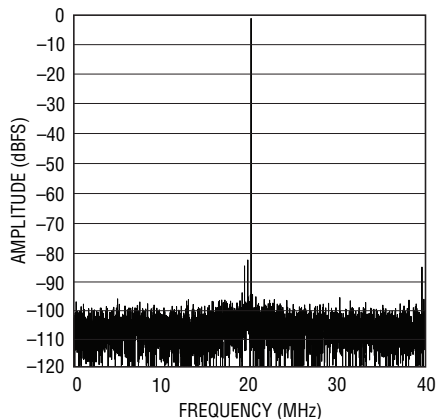

217512 G46

**LTC2173-12: 8k Point 2-Tone FFT,**  
 $f_{IN} = 70\text{MHz}, 75\text{MHz}, -1\text{dBFS},$   
 $80\text{Mps}$

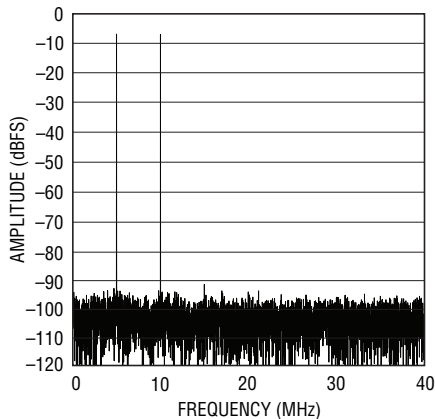

217512 G47

**LTC2173-12: Shorted Input Histogram**

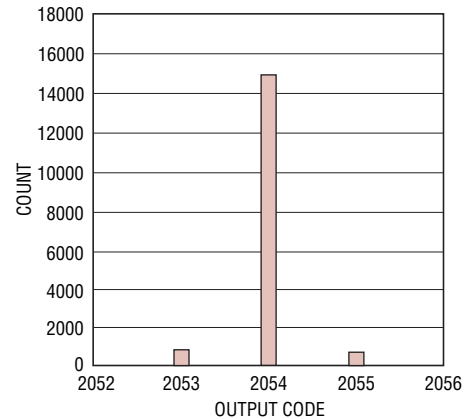

217512 G48  
21754312fa

## TYPICAL PERFORMANCE CHARACTERISTICS

**LTC2173-12: SNR vs Input Frequency, -1dB, 2V Range, 80Msps**

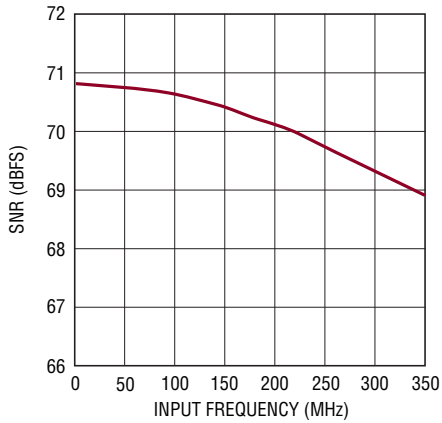

217512 G49

**LTC2173-12: SFDR vs Input Frequency, -1dB, 2V Range, 80Msps**

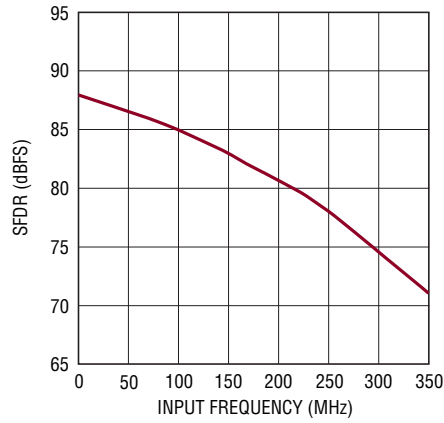

217512 G35a

**LTC2173-12: SFDR vs Input Level,  $f_{IN} = 70\text{MHz}$ , 2V Range, 80Msps**

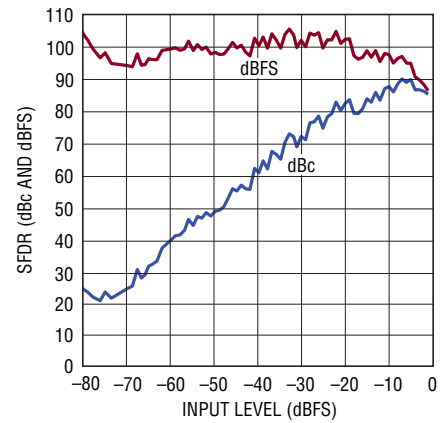

217512 G52

**LTC2173-12:  $I_{VDD}$  vs Sample Rate, 5MHz Sine Wave Input, -1dB**

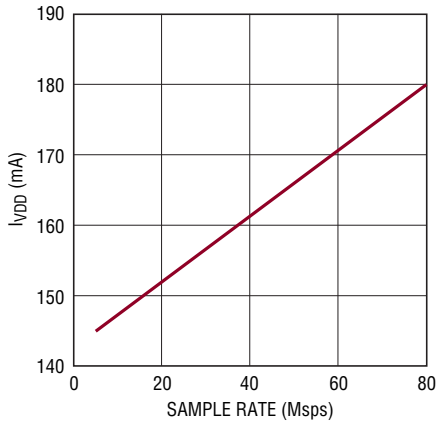

217512 G55

**LTC2173-12: SNR vs SENSE,  $f_{IN} = 5\text{MHz}$ , -1dB**

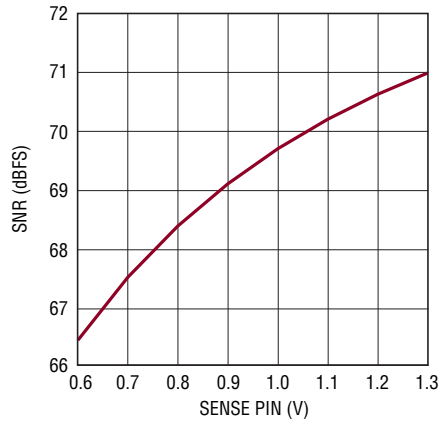

217512 G55a

**DCO Cycle-Cycle Jitter vs Serial Data Rate**

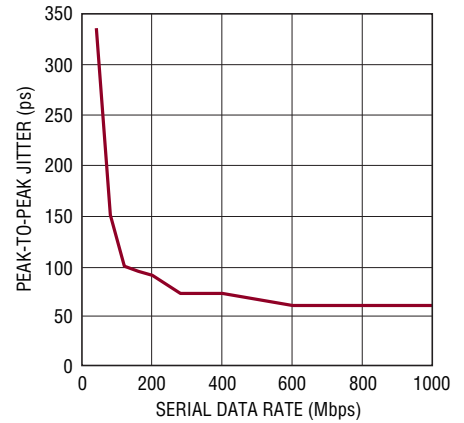

217512 G52a

## PIN FUNCTIONS

**A<sub>IN1</sub><sup>+</sup> (Pin 1):** Channel 1 Positive Differential Analog Input.

**A<sub>IN1</sub><sup>-</sup> (Pin 2):** Channel 1 Negative Differential Analog Input.

**V<sub>CM12</sub> (Pin 3):** Common Mode Bias Output, Nominally Equal to V<sub>DD</sub>/2. V<sub>CM</sub> should be used to bias the common mode of the analog inputs of channels 1 and 2. Bypass to ground with a 0.1μF ceramic capacitor.

**A<sub>IN2</sub><sup>+</sup> (Pin 4):** Channel 2 Positive Differential Analog Input.

**A<sub>IN2</sub><sup>-</sup> (Pin 5):** Channel 2 Negative Differential Analog Input.

**REFH (Pins 6, 7):** ADC High Reference. Bypass to pins 8, 9 with a 2.2μF ceramic capacitor and to ground with a 0.1μF ceramic capacitor.

**REFL (Pins 8, 9):** ADC Low Reference. Bypass to pins 6, 7 with a 2.2μF ceramic capacitor and to ground with a 0.1μF ceramic capacitor.

**A<sub>IN3</sub><sup>+</sup> (Pin 10):** Channel 3 Positive Differential Analog Input.

**A<sub>IN3</sub><sup>-</sup> (Pin 11):** Channel 3 Negative Differential Analog Input.

**V<sub>CM34</sub> (Pin 12):** Common Mode Bias Output, Nominally Equal to V<sub>DD</sub>/2. V<sub>CM</sub> should be used to bias the common mode of the analog inputs of channels 3 and 4. Bypass to ground with a 0.1μF ceramic capacitor.

**A<sub>IN4</sub><sup>+</sup> (Pin 13):** Channel 4 Positive Differential Analog Input.

**A<sub>IN4</sub><sup>-</sup> (Pin 14):** Channel 4 Negative Differential Analog Input.

**V<sub>DD</sub> (Pins 15, 16, 51, 52):** Analog Power Supply, 1.7V to 1.9V. Bypass to ground with 0.1μF ceramic capacitors. Adjacent pins can share a bypass capacitor.

**ENC<sup>+</sup> (Pin 17):** Encode Input. Conversion starts on the rising edge.

**ENC<sup>-</sup> (Pin 18):** Encode Complement Input. Conversion starts on the falling edge.

**$\overline{\text{CS}}$  (Pin 19):** In serial programming mode, ( $\overline{\text{PAR/SER}} = 0\text{V}$ ),  $\overline{\text{CS}}$  is the serial interface chip select input. When  $\overline{\text{CS}}$  is low, SCK is enabled for shifting data on SDI into the mode control registers. In the parallel programming mode ( $\overline{\text{PAR/SER}} = V_{\text{DD}}$ ),  $\overline{\text{CS}}$  selects 2-lane or 1-lane output mode.  $\overline{\text{CS}}$  can be driven with 1.8V to 3.3V logic.

**SCK (Pin 20):** In serial programming mode, ( $\overline{\text{PAR/SER}} = 0\text{V}$ ), SCK is the serial interface clock input. In the parallel programming mode ( $\overline{\text{PAR/SER}} = V_{\text{DD}}$ ), SCK selects 3.5mA or 1.75mA LVDS output currents. SCK can be driven with 1.8V to 3.3V logic.

**SDI (Pin 21):** In serial programming mode, ( $\overline{\text{PAR/SER}} = 0\text{V}$ ), SDI is the serial interface data Input. Data on SDI is clocked into the mode control registers on the rising edge of SCK. In the parallel programming mode ( $\overline{\text{PAR/SER}} = V_{\text{DD}}$ ), SDI can be used to power down the part. SDI can be driven with 1.8V to 3.3V logic.

**GND (Pins 22, 45, 49, Exposed Pad Pin 53):** ADC Power Ground. The exposed pad must be soldered to the PCB ground.

**OGND (Pin 33):** Output Driver Ground. Must be shorted to the ground plane by a very low inductance path. Use multiple vias close to the pin.

**OV<sub>DD</sub> (Pin 34):** Output Driver Supply, 1.7V to 1.9V. Bypass to ground with a 0.1μF ceramic capacitor.

**SDO (Pin 46):** In serial programming mode, ( $\overline{\text{PAR/SER}} = 0\text{V}$ ), SDO is the optional serial interface data output. Data on SDO is read back from the mode control registers and can be latched on the falling edge of SCK. SDO is an open-drain NMOS output that requires an external 2k pull-up resistor to 1.8V – 3.3V. If read back from the mode control registers is not needed, the pull-up resistor is not necessary and SDO can be left unconnected. In the parallel programming mode ( $\overline{\text{PAR/SER}} = V_{\text{DD}}$ ), SDO is an input that enables internal 100Ω termination resistors on the digital outputs. When used as an input, SDO can be driven with 1.8V to 3.3V logic through a 1k series resistor.

**$\overline{\text{PAR/SER}}$  (Pin 47):** Programming Mode Selection Pin. Connect to ground to enable the serial programming mode.  $\overline{\text{CS}}$ , SCK, SDI, SDO become a serial interface that control the A/D operating modes. Connect to V<sub>DD</sub> to enable the parallel programming mode where  $\overline{\text{CS}}$ , SCK, SDI, SDO become parallel logic inputs that control a reduced set of the A/D operating modes.  $\overline{\text{PAR/SER}}$  should be connected directly to ground or the V<sub>DD</sub> of the part and not be driven by a logic signal.



## PIN FUNCTIONS

**V<sub>REF</sub> (Pin 48):** Reference Voltage Output. Bypass to ground with a 1 $\mu$ F ceramic capacitor, nominally 1.25V.

**SENSE (Pin 50):** Reference Programming Pin. Connecting SENSE to V<sub>DD</sub> selects the internal reference and a  $\pm 1$ V input range. Connecting SENSE to ground selects the internal reference and a  $\pm 0.5$ V input range. An external reference between 0.625V and 1.3V applied to SENSE selects an input range of  $\pm 0.8 \cdot V_{\text{SENSE}}$ .

### LVDS Outputs

All pins in this section are differential LVDS outputs. The output current level is programmable. There is an optional internal 100 $\Omega$  termination resistor between the pins of each LVDS output pair.

**OUT4B<sup>-</sup>/OUT4B<sup>+</sup>, OUT4A<sup>-</sup>/OUT4A<sup>+</sup> (Pins 23/24, Pins 25/26):** Serial data outputs for Channel 4. In 1-lane output mode only OUT4A<sup>-</sup>/OUT4A<sup>+</sup> are used.

**OUT3B<sup>-</sup>/OUT3B<sup>+</sup>, OUT3A<sup>-</sup>/OUT3A<sup>+</sup> (Pins 27/28, Pins 29/30):** Serial data outputs for Channel 3. In 1-lane output mode only OUT3A<sup>-</sup>/OUT3A<sup>+</sup> are used.

**FR<sup>-</sup>/FR<sup>+</sup> (Pins 31/32):** Frame Start Outputs.

**DCO<sup>-</sup>/DCO<sup>+</sup> (Pins 35/36):** Data Clock Outputs.

**OUT2B<sup>-</sup>/OUT2B<sup>+</sup>, OUT2A<sup>-</sup>/OUT2A<sup>+</sup> (Pins 37/38, Pins 39/40):** Serial data outputs for Channel 2. In 1-lane output mode only OUT2A<sup>-</sup>/OUT2A<sup>+</sup> are used.

**OUT1B<sup>-</sup>/OUT1B<sup>+</sup>, OUT1A<sup>-</sup>/OUT1A<sup>+</sup> (Pins 41/42, Pins 43/44):** Serial data outputs for Channel 1. In 1-lane output mode only OUT1A<sup>-</sup>/OUT1A<sup>+</sup> are used.

## FUNCTIONAL BLOCK DIAGRAM

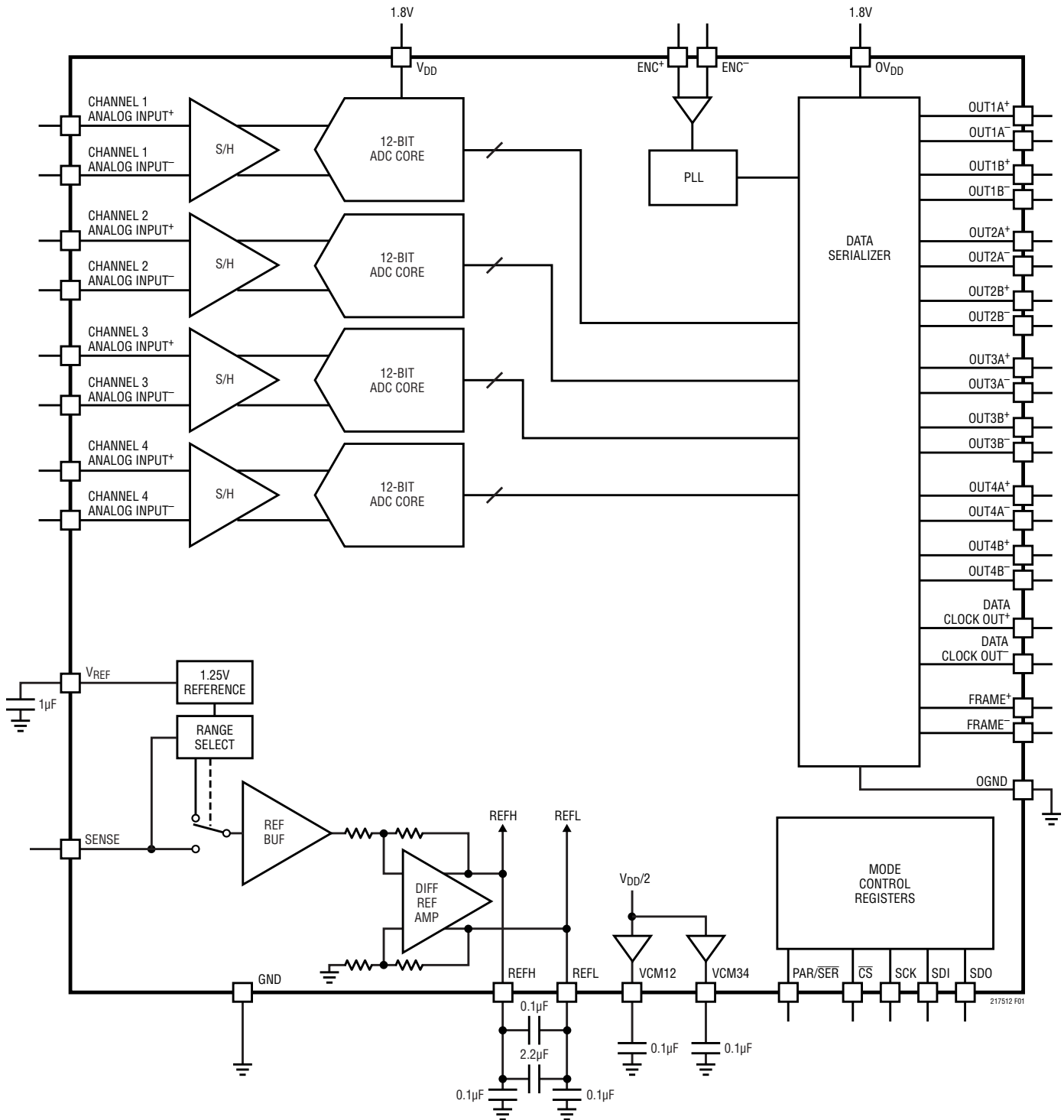

Figure 1. Functional Block Diagram

## APPLICATIONS INFORMATION

### CONVERTER OPERATION

The LTC2175-12/LTC2174-12/LTC2173-12 are low power, 4-channel, 12-bit, 125Msps/105Msps/80Msps A/D converters that are powered by a single 1.8V supply. The analog inputs should be driven differentially. The encode input can be driven differentially for optimal jitter performance, or single-ended for lower power consumption. The digital outputs are serial LVDS to minimize the number of data lines. Each channel outputs two bits at a time (2-lane mode). At lower sampling rates there is a one bit per channel option (1-lane mode). Many additional features can be chosen by programming the mode control registers through a serial SPI port.

### ANALOG INPUT

The analog inputs are differential CMOS sample-and-hold circuits (Figure 2). The inputs should be driven differentially around a common mode voltage set by the  $V_{CM12}$  or  $V_{CM34}$  output pins, which are nominally  $V_{DD}/2$ . For the

2V input range, the inputs should swing from  $V_{CM} - 0.5V$  to  $V_{CM} + 0.5V$ . There should be  $180^\circ$  phase difference between the inputs.

The four channels are simultaneously sampled by a shared encode circuit (Figure 2).

### INPUT DRIVE CIRCUITS

#### Input Filtering

If possible, there should be an RC low pass filter right at the analog inputs. This lowpass filter isolates the drive circuitry from the A/D sample-and-hold switching, and also limits wideband noise from the drive circuitry. Figure 3 shows an example of an input RC filter. The RC component values should be chosen based on the application's input frequency.

#### Transformer Coupled Circuits

Figure 3 shows the analog input being driven by an RF transformer with a center-tapped secondary. The center

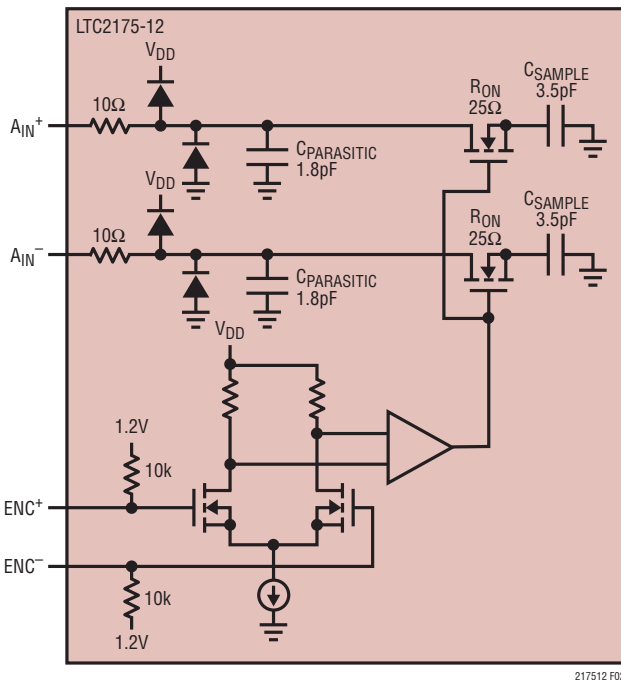

Figure 2. Equivalent Input Circuit. Only One of the Four Analog Channels Is Shown.

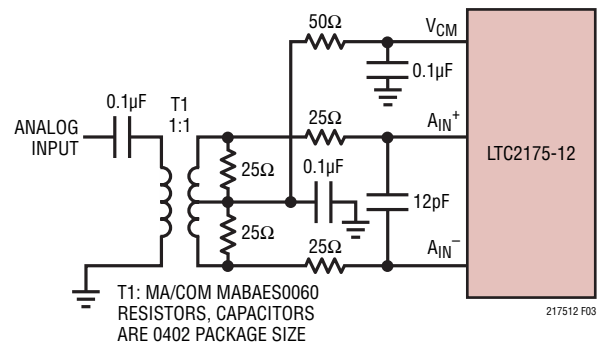

Figure 3. Analog Input Circuit Using a Transformer. Recommended for Input Frequencies from 5MHz to 70MHz.

## APPLICATIONS INFORMATION

tap is biased with  $V_{CM}$ , setting the A/D input at its optimal DC level. At higher input frequencies a transmission line balun transformer (Figures 4 to 6) has better balance, resulting in lower A/D distortion.

### Amplifier Circuits

Figure 7 shows the analog input being driven by a high speed differential amplifier. The output of the amplifier is AC-coupled to the A/D so the amplifier's output common mode voltage can be optimally set to minimize distortion.

At very high frequencies an RF gain block will often have lower distortion than a differential amplifier. If the gain block is single-ended, then a transformer circuit (Figures 4 to 6) should convert the signal to differential before driving the A/D.

### Reference

The LTC2175-12/LTC2174-12/LTC2173-12 has an internal 1.25V voltage reference. For a 2V input range using the internal reference, connect SENSE to  $V_{DD}$ . For a 1V input range using the internal reference, connect SENSE to

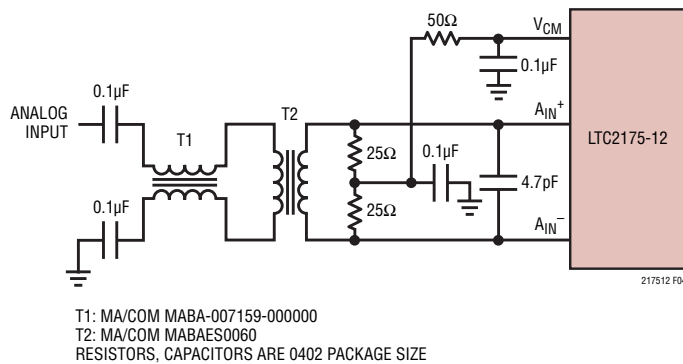

Figure 4. Recommended Front End Circuit for Input Frequencies from 70MHz to 170MHz

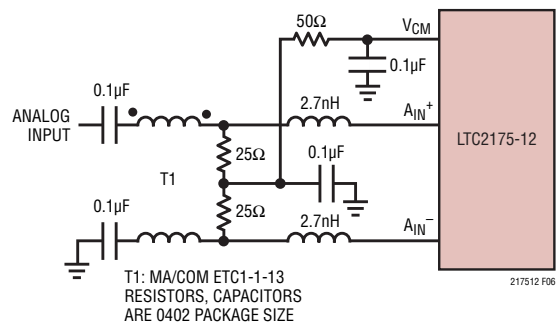

Figure 6. Recommended Front End Circuit for Input Frequencies Above 300MHz

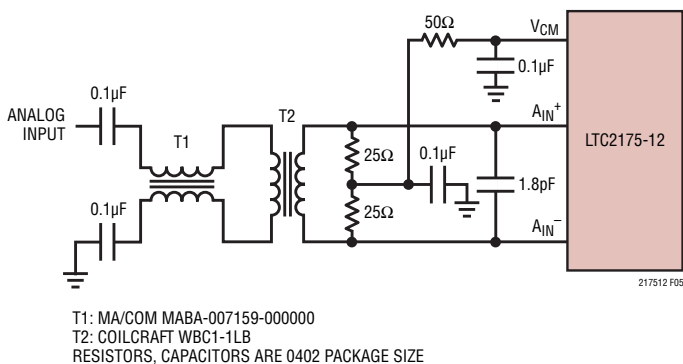

Figure 5. Recommended Front End Circuit for Input Frequencies from 170MHz to 300MHz

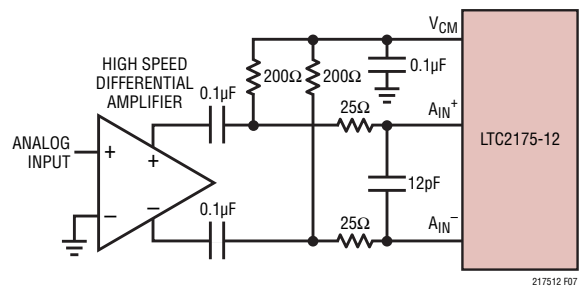

Figure 7. Front End Circuit Using a High Speed Differential Amplifier

## APPLICATIONS INFORMATION

ground. For a 2V input range with an external reference, apply a 1.25V reference voltage to SENSE (Figure 9).

The input range can be adjusted by applying a voltage to SENSE that is between 0.625V and 1.30V. The input range will then be  $1.6 \cdot V_{SENSE}$ .

The reference is shared by all four ADC channels, so it is not possible to independently adjust the input range of individual channels.

The  $V_{REF}$ , REFH and REFL pins should be bypassed as shown in Figure 8. The 0.1 $\mu$ F capacitor between REFH

and REFL should be as close to the pins as possible (not on the backside of the circuit board).

### Encode Input

The signal quality of the encode inputs strongly affects the A/D noise performance. The encode inputs should be treated as analog signals—do not route them next to digital traces on the circuit board. There are two modes of operation for the encode inputs: the differential encode mode (Figure 10), and the single-ended encode mode (Figure 11).

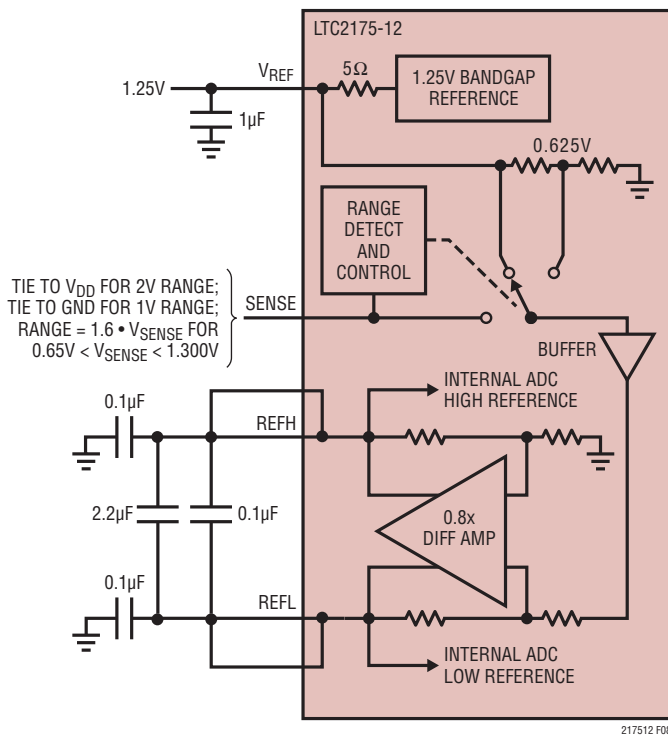

Figure 8. Reference Circuit

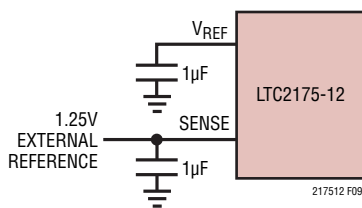

Figure 9. Using an External 1.25V Reference

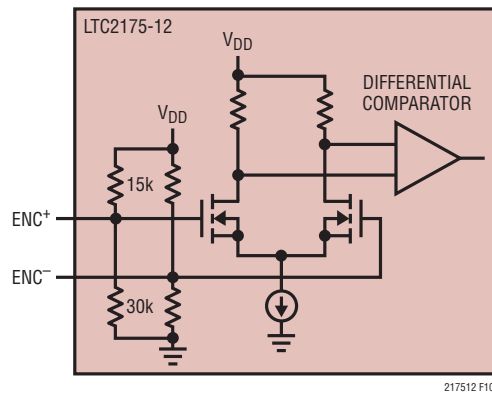

Figure 10. Equivalent Encode Input Circuit for Differential Encode Mode

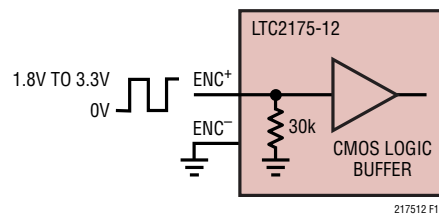

Figure 11. Equivalent Encode Input Circuit for Single-Ended Encode Mode

## APPLICATIONS INFORMATION

The differential encode mode is recommended for sinusoidal, PECL, or LVDS encode inputs (Figures 12 and 13). The encode inputs are internally biased to 1.2V through 10k equivalent resistance. The encode inputs can be taken above  $V_{DD}$  (up to 3.6V), and the common mode range is from 1.1V to 1.6V. In the differential encode mode,  $ENC^-$  should stay at least 200mV above ground to avoid falsely triggering the single-ended encode mode. For good jitter performance  $ENC^+$  should have fast rise and fall times.

The single-ended encode mode should be used with CMOS encode inputs. To select this mode,  $ENC^-$  is connected to ground and  $ENC^+$  is driven with a square wave encode input.  $ENC^+$  can be taken above  $V_{DD}$  (up to 3.6V) so 1.8V to 3.3V CMOS logic levels can be used. The  $ENC^+$  threshold

is 0.9V. For good jitter performance  $ENC^+$  should have fast rise and fall times.

### Clock PLL and Duty Cycle Stabilizer

The encode clock is multiplied by an internal phase-locked loop (PLL) to generate the serial digital output data. If the encode signal changes frequency or is turned off, the PLL requires 25 $\mu$ s to lock onto the input clock.

A clock duty cycle stabilizer circuit allows the duty cycle of the applied encode signal to vary from 30% to 70%. In the serial programming mode it is possible to disable the duty cycle stabilizer, but this is not recommended. In the parallel programming mode the duty cycle stabilizer is always enabled.

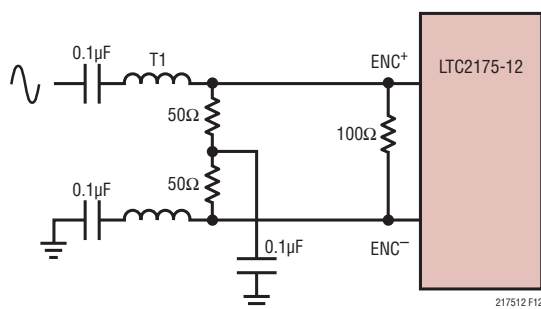

T1 = MA/COM ETC1-1-13  
RESISTORS AND CAPACITORS  
ARE 0402 PACKAGE SIZE

Figure 12. Sinusoidal Encode Drive

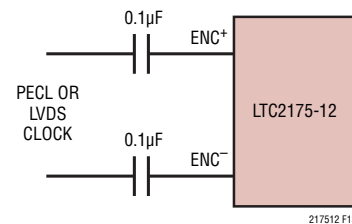

Figure 13. PECL or LVDS Encode Drive

## APPLICATIONS INFORMATION

### DIGITAL OUTPUTS

The digital outputs of the LTC2175-12/LTC2174-12/LTC2173-12 are serialized LVDS signals. Each channel outputs two bits at a time (2-lane mode). At lower sampling rates there is a one bit per channel option (1-lane mode). The data can be serialized with 16, 14, or 12-bit serialization (see timing diagrams for details).

The output data should be latched on the rising and falling edges of the data clock out (DCO). A data frame output (FR) can be used to determine when the data from a new conversion result begins. In the 2-lane, 14-bit serialization mode, the frequency of the FR output is halved.

The maximum serial data rate for the data outputs is 1Gbps, so the maximum sample rate of the ADC will depend on the serialization mode as well as the speed grade of the ADC (see Table 1). The minimum sample rate for all serialization modes is 5Msps.

By default the outputs are standard LVDS levels: 3.5mA output current and a 1.25V output common mode voltage. An external 100Ω differential termination resistor is required for each LVDS output pair. The termination resistors should be located as close as possible to the LVDS receiver.

The outputs are powered by  $OV_{DD}$  and  $OGND$  which are isolated from the A/D core power and ground.

### Programmable LVDS Output Current

The default output driver current is 3.5mA. This current can be adjusted by control register A2 in the serial programming mode. Available current levels are 1.75mA, 2.1mA, 2.5mA, 3mA, 3.5mA, 4mA and 4.5mA. In the parallel programming mode the SCK pin can select either 3.5mA or 1.75mA.

### Optional LVDS Driver Internal Termination

In most cases using just an external 100Ω termination resistor will give excellent LVDS signal integrity. In addition, an optional internal 100Ω termination resistor can be enabled by serially programming mode control register A2. The internal termination helps absorb any reflections caused by imperfect termination at the receiver. When the internal termination is enabled, the output driver current is doubled to maintain the same output voltage swing. In the parallel programming mode the SDO pin enables internal termination. Internal termination should only be used with 1.75mA, 2.1mA or 2.5mA LVDS output current modes.

**Table 1. Maximum Sampling Frequency for All Serialization Modes. Note That These Limits Are for the LTC2175-12. The Sampling Frequency for the Slower Speed Grades Cannot Exceed 105MHz (LTC2174-12) or 80MHz (LTC2173-12).**

SERIALIZATION MODE		MAXIMUM SAMPLING FREQUENCY, $f_S$ (MHz)	DCO FREQUENCY	FR FREQUENCY	SERIAL DATA RATE
2-Lane	16-Bit Serialization	125	$4 \cdot f_S$	$f_S$	$8 \cdot f_S$
2-Lane	14-Bit Serialization	125	$3.5 \cdot f_S$	$0.5 \cdot f_S$	$7 \cdot f_S$
2-Lane	12-Bit Serialization	125	$3 \cdot f_S$	$f_S$	$6 \cdot f_S$
1-Lane	16-Bit Serialization	62.5	$8 \cdot f_S$	$f_S$	$16 \cdot f_S$
1-Lane	14-Bit Serialization	71.4	$7 \cdot f_S$	$f_S$	$14 \cdot f_S$
1-Lane	12-Bit Serialization	83.3	$6 \cdot f_S$	$f_S$	$12 \cdot f_S$

## APPLICATIONS INFORMATION

### DATA FORMAT

Table 2 shows the relationship between the analog input voltage and the digital data output bits. By default the output data format is offset binary. The 2's complement format can be selected by serially programming mode control register A1.

In addition to the 12 data bits (D11 - D0), two additional bits ( $D_X$  and  $D_Y$ ) are sent out in the 14-bit and 16-bit serialization modes. These extra bits are to ensure complete software compatibility with the 14-bit versions of these A/Ds. During normal operation when the analog inputs are not overranged,  $D_X$  and  $D_Y$  are always logic 0. When the analog inputs are overranged positive,  $D_X$  and  $D_Y$  become logic 1. When the analog inputs are overranged negative,  $D_X$  and  $D_Y$  become logic 0.  $D_X$  and  $D_Y$  can also be controlled by the digital output test pattern. See the Timing Diagrams section for more information.

**Table 2. Output Codes vs Input Voltage**

$A_{IN}^+ - A_{IN}^-$ (2V RANGE)	D11-D0 (OFFSET BINARY)	D11-D0 (2's COMPLEMENT)	$D_X, D_Y$
>+1.000000V	1111 1111 1111	0111 1111 1111	11
+0.999512V	1111 1111 1111	0111 1111 1111	00
+0.999024V	1111 1111 1110	0111 1111 1110	00
+0.000488V	1000 0000 0001	0000 0000 0001	00
0.000000V	1000 0000 0000	0000 0000 0000	00
-0.000488V	0111 1111 1111	1111 1111 1111	00
-0.000976V	0111 1111 1110	1111 1111 1110	00
-0.999512V	0000 0000 0001	1000 0000 0001	00
-1.000000V	0000 0000 0000	1000 0000 0000	00
≤-1.000000V	0000 0000 0000	1000 0000 0000	00

### Digital Output Randomizer

Interference from the A/D digital outputs is sometimes unavoidable. Digital interference may be from capacitive or inductive coupling or coupling through the ground plane. Even a tiny coupling factor can cause unwanted tones in the ADC output spectrum. By randomizing the digital

output before it is transmitted off chip, these unwanted tones can be randomized which reduces the unwanted tone amplitude.

The digital output is *randomized* by applying an exclusive-OR logic operation between the LSB and all other data output bits. To decode, the reverse operation is applied—an exclusive-OR operation is applied between the LSB and all other bits. The FR and DCO outputs are not affected. The output randomizer is enabled by serially programming mode control register A1.

### Digital Output Test Pattern

To allow in-circuit testing of the digital interface to the A/D, there is a test mode that forces the A/D data outputs (D11-D0,  $D_X$ ,  $D_Y$ ) of all channels to known values. The digital output test patterns are enabled by serially programming mode control registers A3 and A4. When enabled, the test patterns override all other formatting modes: 2's complement and randomizer.

### Output Disable

The digital outputs may be disabled by serially programming mode control register A2. The current drive for all digital outputs including DCO and FR are disabled to save power or enable in-circuit testing. When disabled the common mode of each output pair becomes high impedance, but the differential impedance may remain low.

### Sleep and Nap Modes

The A/D may be placed in sleep or nap modes to conserve power. In sleep mode the entire chip is powered down, resulting in 1mW power consumption. Sleep mode is enabled by mode control register A1 (serial programming mode), or by SDI (parallel programming mode). The amount of time required to recover from sleep mode depends on the size of the bypass capacitors on  $V_{REF}$ , REFH, and REFL. For the suggested values in Figure 8, the A/D will stabilize after 2ms.



## APPLICATIONS INFORMATION

In nap mode any combination of A/D channels can be powered down while the internal reference circuits and the PLL stay active, allowing faster wakeup than from sleep mode. Recovering from nap mode requires at least 100 clock cycles. If the application demands very accurate DC settling then an additional 50 $\mu$ s should be allowed so the on-chip references can settle from the slight temperature shift caused by the change in supply current as the A/D leaves nap mode. Nap mode is enabled by mode control register A1 in the serial programming mode.

### DEVICE PROGRAMMING MODES

The operating modes of the LTC2175-12/LTC2174-12/LTC2173-12 can be programmed by either a parallel interface or a simple serial interface. The serial interface has more flexibility and can program all available modes. The parallel interface is more limited and can only program some of the more commonly used modes.

#### Parallel Programming Mode

To use the parallel programming mode,  $\overline{\text{PAR/SER}}$  should be tied to  $V_{\text{DD}}$ . The  $\overline{\text{CS}}$ , SCK, SDI and SDO pins are binary logic inputs that set certain operating modes. These pins can be tied to  $V_{\text{DD}}$  or ground, or driven by 1.8V, 2.5V, or 3.3V CMOS logic. When used as an input, SDO should be driven through a 1k series resistor. Table 3 shows the modes set by  $\overline{\text{CS}}$ , SCK, SDI and SDO.

#### Serial Programming Mode

To use the serial programming mode,  $\overline{\text{PAR/SER}}$  should be tied to ground. The  $\overline{\text{CS}}$ , SCK, SDI and SDO pins become a serial interface that program the A/D mode control registers. Data is written to a register with a 16-bit serial word. Data can also be read back from a register to verify its contents.

Serial data transfer starts when  $\overline{\text{CS}}$  is taken low. The data on the SDI pin is latched at the first 16 rising edges of SCK. Any SCK rising edges after the first 16 are ignored. The data transfer ends when  $\overline{\text{CS}}$  is taken high again.

The first bit of the 16-bit input word is the  $\overline{\text{R/W}}$  bit. The next seven bits are the address of the register (A6:A0). The final eight bits are the register data (D7:D0).

If the  $\overline{\text{R/W}}$  bit is low, the serial data (D7:D0) will be written to the register set by the address bits (A6:A0). If the  $\overline{\text{R/W}}$  bit is high, data in the register set by the address bits (A6:A0) will be read back on the SDO pin (see the Timing Diagrams sections). During a read back command the register is not updated and data on SDI is ignored.

The SDO pin is an open-drain output that pulls to ground with a 200 $\Omega$  impedance. If register data is read back through SDO, an external 2k pull-up resistor is required. If serial data is only written and read back is not needed, then SDO can be left floating and no pull-up resistor is needed. Table 4 shows a map of the mode control registers.

**Table 3. Parallel Programming Mode Control Bits ( $\overline{\text{PAR/SER}} = V_{\text{DD}}$ )**

Pin	DESCRIPTION
$\overline{\text{CS}}$	<b>2-Lane / 1-Lane Selection Bit</b> 0 = 2-Lane, 16-Bit Serialization Output Mode 1 = 1-Lane, 14-Bit Serialization Output Mode
SCK	<b>LVDS Current Selection Bit</b> 0 = 3.5mA LVDS Current Mode 1 = 1.75mA LVDS Current Mode
SDI	<b>Power Down Control Bit</b> 0 = Normal Operation 1 = Sleep Mode
SDO	<b>Internal Termination Selection Bit</b> 0 = Internal Termination Disabled 1 = Internal Termination Enabled

## APPLICATIONS INFORMATION

### Software Reset

If serial programming is used, the mode control registers should be programmed as soon as possible after the power supplies turn on and are stable. The first serial command must be a software reset which will reset all register data bits to logic 0. To perform a software reset, bit D7 in the reset register is written with a logic 1. After the reset SPI write command is complete, bit D7 is automatically set back to zero.

### GROUNDING AND BYPASSING

The LTC2175-12/LTC2174-12/LTC2173-12 requires a printed circuit board with a clean unbroken ground plane. A multilayer board with an internal ground plane in the first layer beneath the ADC is recommended. Layout for the printed circuit board should ensure that digital and analog signal lines are separated as much as possible. In particular, care should be taken not to run any digital track alongside an analog signal track or underneath the ADC.

High quality ceramic bypass capacitors should be used at the  $V_{DD}$ ,  $OV_{DD}$ ,  $V_{CM}$ ,  $V_{REF}$ , REFH and REFL pins.

Bypass capacitors must be located as close to the pins as possible. Of particular importance is the 0.1 $\mu$ F capacitor between REFH and REFL. This capacitor should be on the same side of the circuit board as the A/D, and as close to the device as possible (1.5mm or less). Size 0402 ceramic capacitors are recommended. The larger 2.2 $\mu$ F capacitor between REFH and REFL can be somewhat further away. The traces connecting the pins and bypass capacitors must be kept short and should be made as wide as possible.

The analog inputs, encode signals, and digital outputs should not be routed next to each other. Ground fill and grounded vias should be used as barriers to isolate these signals from each other.

### HEAT TRANSFER

Most of the heat generated by the LTC2175-12/LTC2174-12/LTC2173-12 is transferred from the die through the bottom-side Exposed Pad and package leads onto the printed circuit board. For good electrical and thermal performance, the Exposed Pad must be soldered to a large grounded pad on the PC board. This pad should be connected to the internal ground planes by an array of vias.

**Table 4. Serial Programming Mode Register Map (PAR/ $\overline{SER}$  = GND)**

#### REGISTER A0: RESET REGISTER (ADDRESS 00h)

D7	D6	D5	D4	D3	D2	D1	D0
RESET	X	X	X	X	X	X	X

Bit 7 **RESET** Software Reset Bit

0 = Not Used

1 = Software Reset. All Mode Control Registers are Reset to 00h. The ADC is Momentarily Placed in SLEEP Mode.

This Bit is Automatically Set Back to Zero at the End of the SPI Write Command.

The Reset Register is Write Only.

Bits 6-0 Unused, Don't Care Bits.

#### REGISTER A1: FORMAT AND POWER-DOWN REGISTER (ADDRESS 01h)

D7	D6	D5	D4	D3	D2	D1	D0
DCSOFF	RAND	TWOSCOMP	SLEEP	NAP_4	NAP_3	NAP_2	NAP_1

Bit 7 **DCSOFF** Clock Duty Cycle Stabilizer Bit

0 = Clock Duty Cycle Stabilizer On

1 = Clock Duty Cycle Stabilizer Off. This is Not Recommended.

Bit 6 **RAND** Data Output Randomizer Mode Control Bit

0 = Data Output Randomizer Mode Off

1 = Data Output Randomizer Mode On

Bit 5 **TWOSCOMP** Two's Complement Mode Control Bit

0 = Offset Binary Data Format

1 = Two's Complement Data Format

## APPLICATIONS INFORMATION

Bits 4-0 **SLEEP: NAP\_4:NAP\_1** Sleep/Nap Mode Control Bits  
 00000 = Normal Operation  
 0XXX1 = Channel 1 in Nap Mode  
 0XX1X = Channel 2 in Nap Mode  
 0X1XX = Channel 3 in Nap Mode  
 01XXX = Channel 4 in Nap Mode  
 1XXXX = Sleep Mode. All Channels are Disabled  
 Note: Any Combination of Channels Can Be Placed in Nap Mode.

### REGISTER A2: OUTPUT MODE REGISTER (ADDRESS 02h)

	D7	D6	D5	D4	D3	D2	D1	D0
	ILVDS2	ILVDS1	ILVDS0	TERMON	OUTOFF	OUTMODE2	OUTMODE1	OUTMODE0
Bits 7-5	<b>ILVDS2:ILVDS0</b> LVDS Output Current Bits 000 = 3.5mA LVDS Output Driver Current 001 = 4.0mA LVDS Output Driver Current 010 = 4.5mA LVDS Output Driver Current 011 = Not Used 100 = 3.0mA LVDS Output Driver Current 101 = 2.5mA LVDS Output Driver Current 110 = 2.1mA LVDS Output Driver Current 111 = 1.75mA LVDS Output Driver Current							
Bit 4	<b>TERMON</b> LVDS Internal Termination Bit 0 = Internal Termination Off 1 = Internal Termination On. LVDS Output Driver Current is 2x the Current Set by ILVDS2:ILVDS0. Internal termination should only be used with 1.75mA, 2.1mA or 2.5mA LVDS output current modes.							
Bit 3	<b>OUTOFF</b> Output Disable Bit 0 = Digital Outputs are Enabled. 1 = Digital Outputs are Disabled.							
Bits 2-0	<b>OUTMODE2:OUTMODE0</b> Digital Output Mode Control Bits 000 = 2-Lanes, 16-Bit Serialization 001 = 2-Lanes, 14-Bit Serialization 010 = 2-Lanes, 12-Bit Serialization 011 = Not Used 100 = Not Used 101 = 1-Lane, 14-Bit Serialization 110 = 1-Lane, 12-Bit Serialization 111 = 1-Lane, 16-Bit Serialization							

### REGISTER A3: TEST PATTERN MSB REGISTER (ADDRESS 03h)

	D7	D6	D5	D4	D3	D2	D1	D0
	OUTTEST	X	TP11	TP10	TP9	TP8	TP7	TP6
Bit 7	<b>OUTTEST</b> Digital Output Test Pattern Control Bit 0 = Digital Output Test Pattern Off 1 = Digital Output Test Pattern On							
Bit 6	Unused, Don't Care Bit.							
Bits 5-0	<b>TP11:TP6</b> Test Pattern Data Bits (MSB) TP11:TP6 Set the Test Pattern for Data Bit 11(MSB) Through Data Bit 6.							

### REGISTER A4: TEST PATTERN LSB REGISTER (ADDRESS 04h)

	D7	D6	D5	D4	D3	D2	D1	D0
	TP5	TP4	TP3	TP2	TP1	TP0	TPX	TPY
Bits 7-2	<b>TP5:TP0</b> Test Pattern Data Bits (LSB) TP5:TP0 Set the Test Pattern for Data Bit 5 Through Data Bit 0(LSB).							
Bit 1-0	<b>TPX:TPY</b> Set the Test Pattern for Extra Bits D <sub>X</sub> and D <sub>Y</sub> . These Bits are for Compatibility with the 14-Bit Version of the A/D.							

# TYPICAL APPLICATIONS

Silkscreen Top

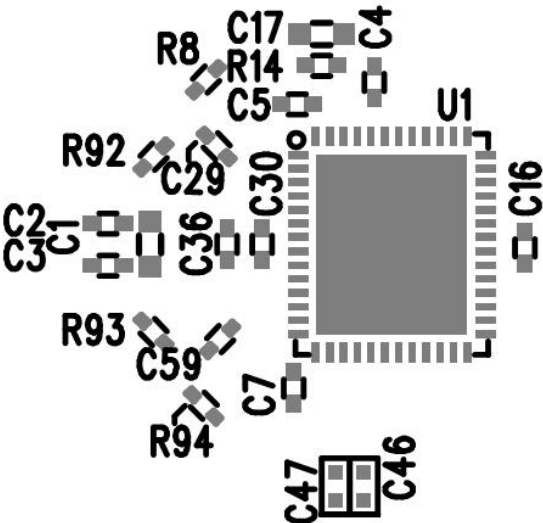

Top Side

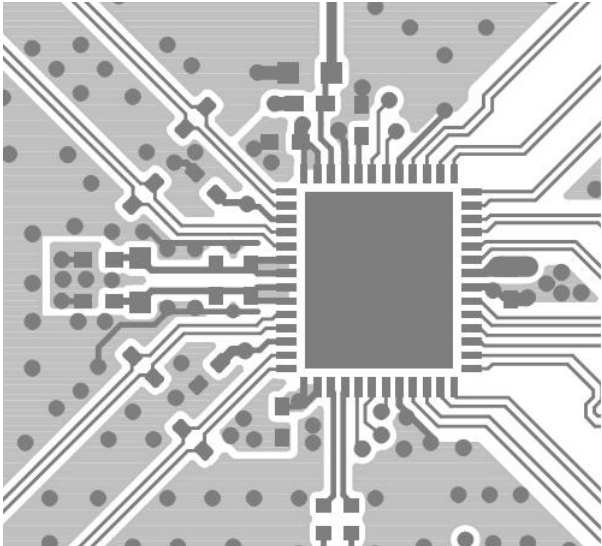

## TYPICAL APPLICATIONS

Inner Layer 2 GND

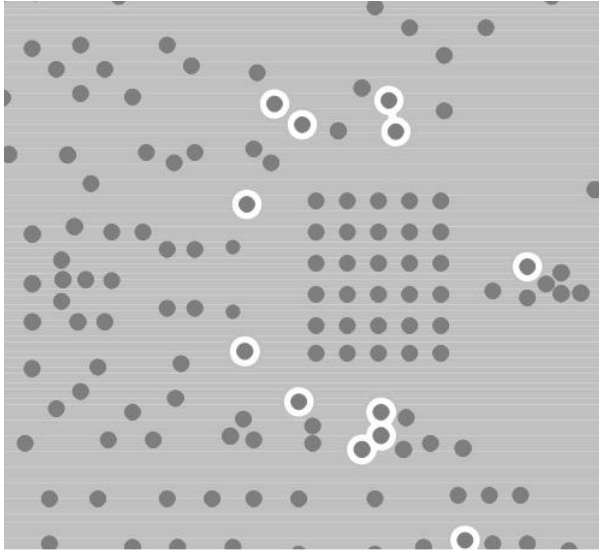

Inner Layer 3

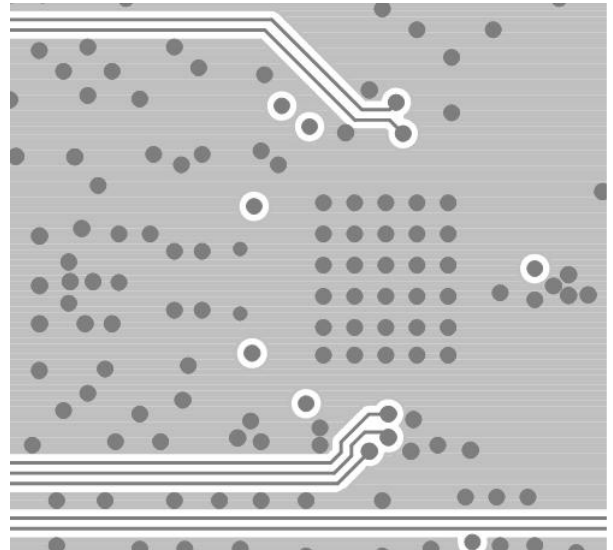

Inner Layer 4

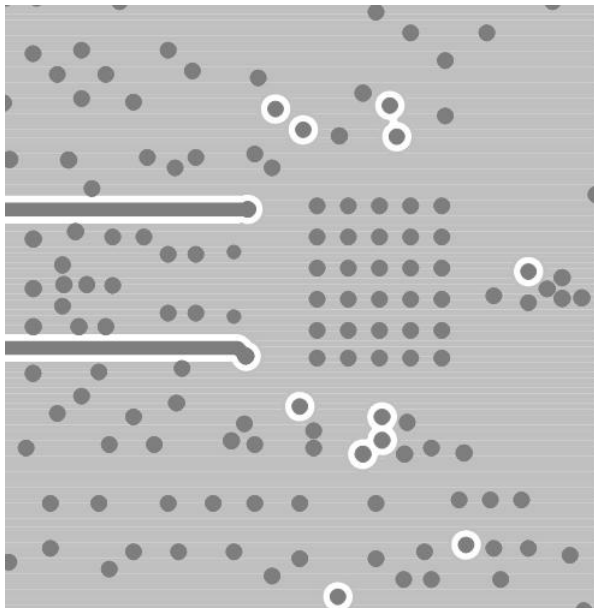

Inner Layer 5 Power

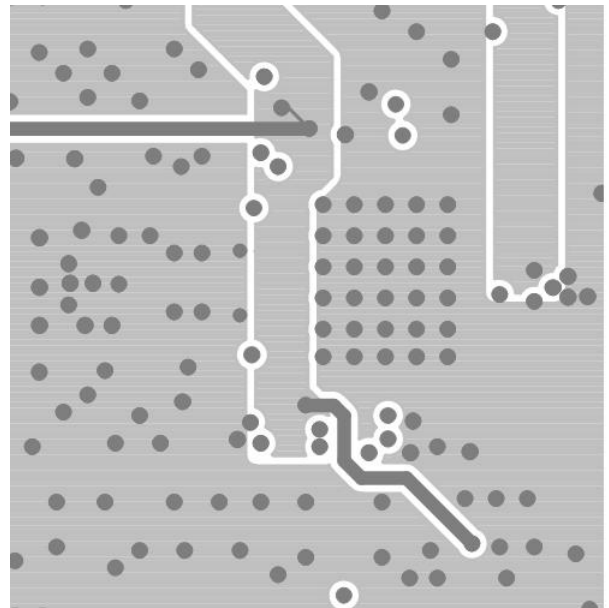

# TYPICAL APPLICATIONS

Bottom Side

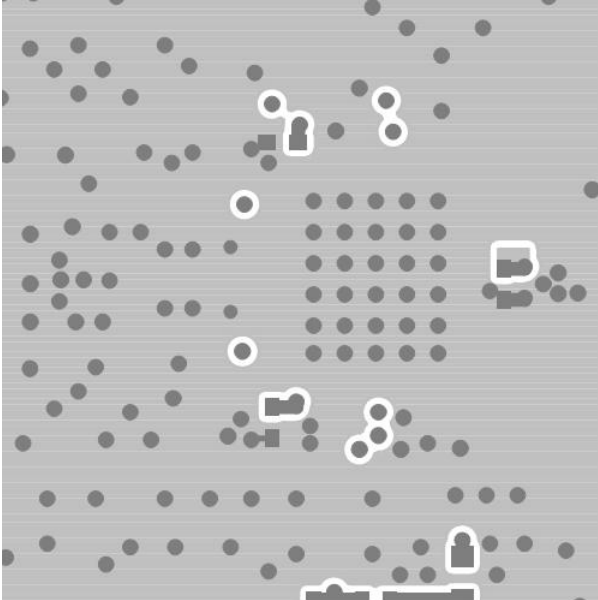

Silkscreen Bottom

C8 □

C9 □

C15 □

TYPICAL APPLICATIONS

LTC2175 Schematic

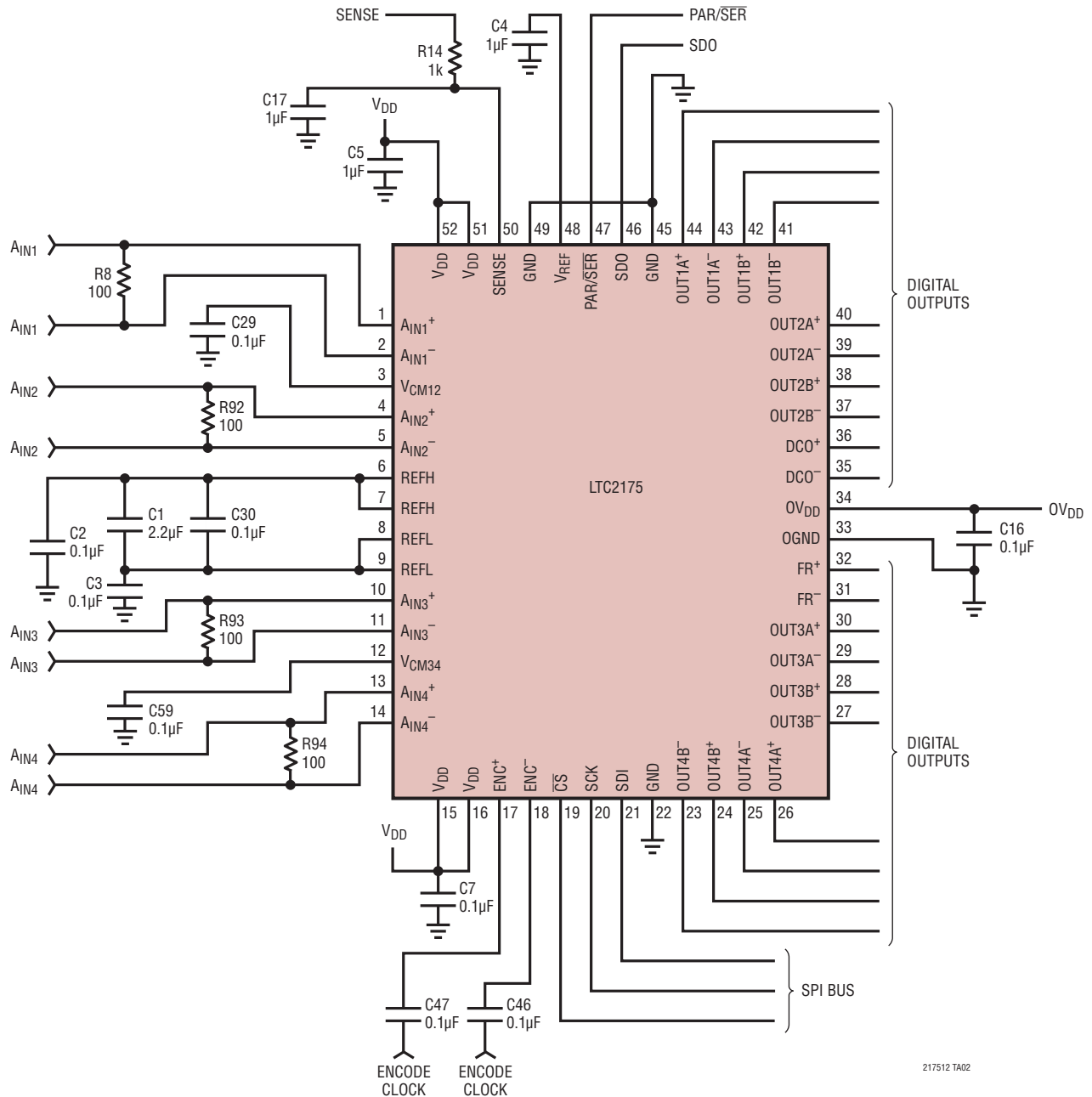

## PACKAGE DESCRIPTION

**UKG Package**  
**52-Lead Plastic QFN (7mm × 8mm)**  
(Reference LTC DWG # 05-08-1729 Rev 0)

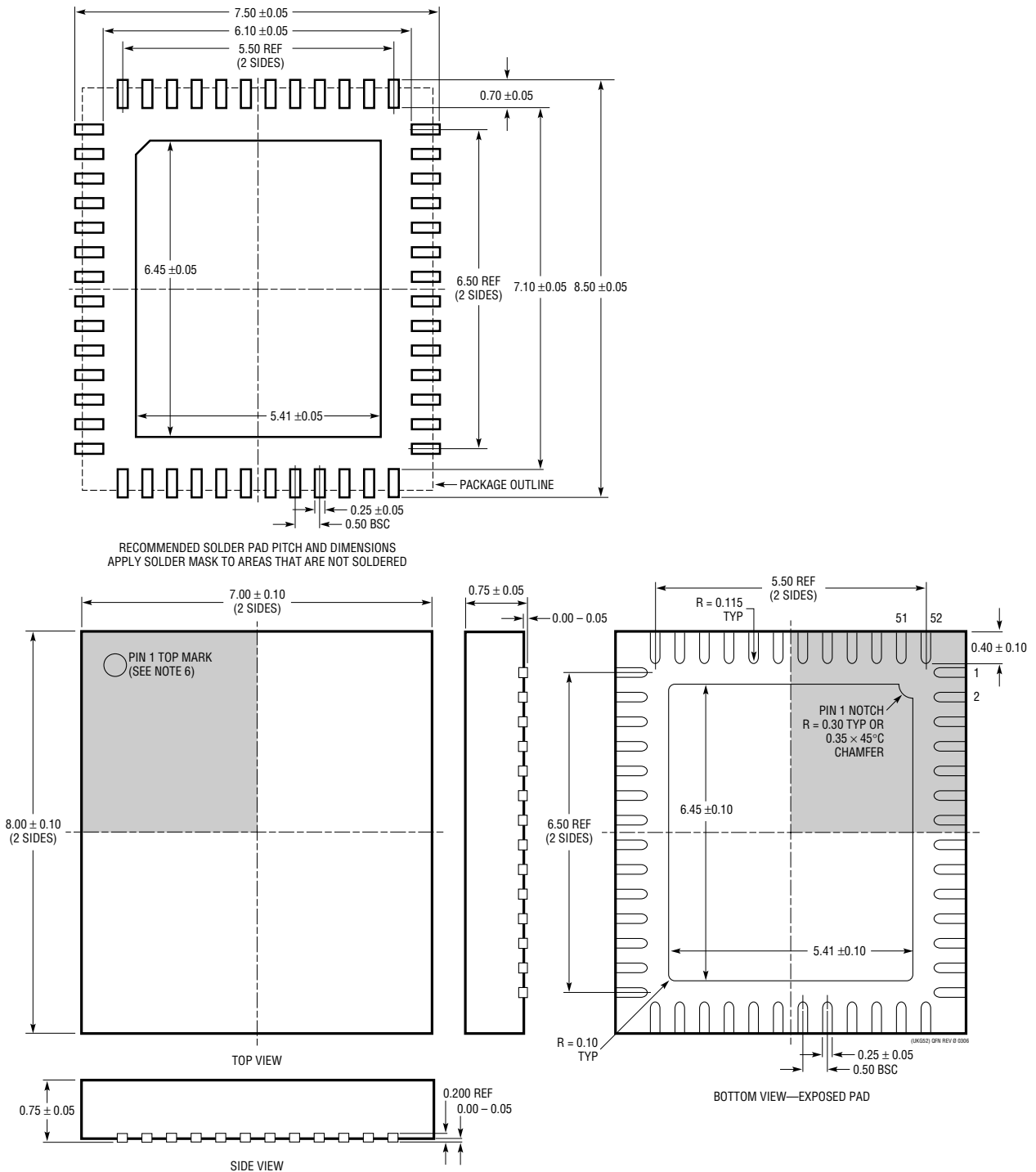

- NOTE:
1. DRAWING IS NOT A JEDEC PACKAGE OUTLINE
  2. DRAWING NOT TO SCALE
  3. ALL DIMENSIONS ARE IN MILLIMETERS
  4. DIMENSIONS OF EXPOSED PAD ON BOTTOM OF PACKAGE DO NOT INCLUDE MOLD FLASH. MOLD FLASH, IF PRESENT, SHALL NOT EXCEED 0.20mm ON ANY SIDE, IF PRESENT
  5. EXPOSED PAD SHALL BE SOLDER PLATED
  6. SHADED AREA IS ONLY A REFERENCE FOR PIN 1 LOCATION ON THE TOP AND BOTTOM OF PACKAGE



## REVISION HISTORY

REV	DATE	DESCRIPTION	PAGE NUMBER
A	6/11	Corrected part numbers in Description.	1
		Revised Software Reset paragraph and Table 4 in Applications Information section.	26
		Added $V_{DD}$ to LTC2175 Schematic in Typical Applications section.	31

# LTC2175-12/ LTC2174-12/LTC2173-12

## RELATED PARTS

PART NUMBER	DESCRIPTION	COMMENTS
<b>ADCs</b>		
LTC2170-14/LTC2171-14/ LTC2172-14	14-Bit, 25Msps/40Msps/65Msps 1.8V Quad ADCs, Ultralow Power	178mW/234mW/360mW, 73.4dB SNR, 85dB SFDR, Serial LVDS Outputs, 7mm × 8mm QFN-52
LTC2170-12/LTC2171-12/ LTC2172-12	12-Bit, 25Msps/40Msps/65Msps 1.8V Quad ADCs, Ultralow Power	178mW/234mW/360mW, 70.5dB SNR, 85dB SFDR, Serial LVDS Outputs, 7mm × 8mm QFN-52
LTC2173-14/LTC2174-14/ LTC2175-14	14-Bit, 80Msps/105Msps/125Msps 1.8V Quad ADCs, Ultralow Power	373mW/445mW/551mW, 73.2 dB SNR, 88dB SFDR, Serial LVDS Outputs, 7mm × 8mm QFN-52
LTC2256-14/LTC2257-14/ LTC2258-14	14-Bit, 25Msps/40Msps/65Msps Msps 1.8V ADCs, Ultralow Power	35mW/49mW/81mW, 74dB SNR, 88dB SFDR, DDR LVDS/DDR CMOS/CMOS Outputs, 6mm × 6mm QFN-36
LTC2259-14/LTC2260-14/ LTC2261-14	14-Bit, 80Msps/105Msps/125Msps 1.8V ADCs, Ultralow Power	89mW/106mW/127mW, 73.4dB SNR, 85dB SFDR, DDR LVDS/DDR CMOS/CMOS Outputs, 6mm × 6mm QFN-36
LTC2262-14	14-Bit, 150Msps 1.8V ADC, Ultralow Power	149mW, 72.8dB SNR, 88dB SFDR, DDR LVDS/DDR CMOS/CMOS Outputs, 6mm × 6mm QFN-36
LTC2263-14/LTC2264-14/ LTC2265-14	14-Bit, 25Msps/40Msps/65Msps 1.8V Dual ADCs, Ultralow Power	99mW/126mW/191mW, 73.4dB SNR, 85dB SFDR, Serial LVDS Outputs, 6mm × 6mm QFN-36
LTC2263-12/LTC2264-12/ LTC2265-12	12-Bit, 25Msps/40Msps/65Msps 1.8V Dual ADCs, Ultralow Power	99mW/126mW/191mW, 70.5dB SNR, 85dB SFDR, Serial LVDS Outputs, 6mm × 6mm QFN-36
LTC2266-14/LTC2267-14/ LTC2268-14	14-Bit, 80Msps/105Msps/125Msps 1.8V Dual ADCs, Ultralow Power	216mW/250mW/293mW, 73.4dB SNR, 85dB SFDR, Serial LVDS Outputs, 6mm × 6mm QFN-36
LTC2266-12/LTC2267-12/ LTC2268-12	12-Bit, 80Msps/105Msps/125Msps 1.8V Dual ADCs, Ultralow Power	216mW/250mW/293mW, 70.5dB SNR, 85dB SFDR, Serial LVDS Outputs, 6mm × 6mm QFN-36
<b>RF Mixers/Demodulators</b>		
LTC5517	40MHz to 900MHz Direct Conversion Quadrature Demodulator	High IIP3: 21dBm at 800MHz, Integrated LO Quadrature Generator
LTC5527	400MHz to 3.7GHz High Linearity Downconverting Mixer	24.5dBm IIP3 at 900MHz, 23.5dBm IIP3 at 3.5GHz, NF = 12.5dB, 50Ω Single-Ended RF and LO Ports
LTC5557	400MHz to 3.8GHz High Linearity Downconverting Mixer	23.7dBm IIP3 at 2.6GHz, 23.5dBm IIP3 at 3.5GHz, NF = 13.2dB, 3.3V Supply Operation, Integrated Transformer
LTC5575	800MHz to 2.7GHz Direct Conversion Quadrature Demodulator	High IIP3: 28dBm at 900MHz, Integrated LO Quadrature Generator, Integrated RF and LO Transformer
<b>Amplifiers/Filters</b>		
LTC6412	800MHz, 31dB Range, Analog-Controlled Variable Gain Amplifier	Continuously Adjustable Gain Control, 35dBm OIP3 at 240MHz, 10dB Noise Figure, 4mm × 4mm QFN-24
LTC6420-20	1.8GHz Dual Low Noise, Low Distortion Differential ADC Drivers for 300MHz IF	Fixed Gain 10V/V, 1nV/√Hz Total Input Noise, 80mA Supply Current per Amplifier, 3mm × 4mm QFN-20
LTC6421-20	1.3GHz Dual Low Noise, Low Distortion Differential ADC Drivers	Fixed Gain 10V/V, 1nV/√Hz Total Input Noise, 40mA Supply Current per Amplifier, 3mm × 4mm QFN-20
LTC6605-7/ LTC6605-10/ LTC6605-14	Dual Matched 7MHz/10MHz/14MHz Filters with ADC Drivers	Dual Matched 2nd Order Lowpass Filters with Differential Drivers, Pin-Programmable Gain, 6mm × 3mm DFN-22
<b>Receiver Subsystems</b>		
LTM9002	14-Bit Dual Channel IF/Baseband Receiver Subsystem	Integrated High Speed ADC, Passive Filters and Fixed Gain Differential Amplifiers

21754312fa



Компания «ЭлектроПласт» предлагает заключение долгосрочных отношений при поставках импортных электронных компонентов на взаимовыгодных условиях!

Наши преимущества:

- Оперативные поставки широкого спектра электронных компонентов отечественного и импортного производства напрямую от производителей и с крупнейших мировых складов;
- Поставка более 17-ти миллионов наименований электронных компонентов;
- Поставка сложных, дефицитных, либо снятых с производства позиций;
- Оперативные сроки поставки под заказ (от 5 рабочих дней);
- Экспресс доставка в любую точку России;
- Техническая поддержка проекта, помощь в подборе аналогов, поставка прототипов;
- Система менеджмента качества сертифицирована по Международному стандарту ISO 9001;
- Лицензия ФСБ на осуществление работ с использованием сведений, составляющих государственную тайну;
- Поставка специализированных компонентов (Xilinx, Altera, Analog Devices, Intersil, Interpoint, Microsemi, Aeroflex, Peregrine, Syfer, Eurofarad, Texas Instrument, Miteq, Cobham, E2V, MA-COM, Hittite, Mini-Circuits, General Dynamics и др.);

Помимо этого, одним из направлений компании «ЭлектроПласт» является направление «Источники питания». Мы предлагаем Вам помощь Конструкторского отдела:

- Подбор оптимального решения, техническое обоснование при выборе компонента;
- Подбор аналогов;
- Консультации по применению компонента;
- Поставка образцов и прототипов;
- Техническая поддержка проекта;
- Защита от снятия компонента с производства.



#### Как с нами связаться

**Телефон:** 8 (812) 309 58 32 (многоканальный)

**Факс:** 8 (812) 320-02-42

**Электронная почта:** [org@eplast1.ru](mailto:org@eplast1.ru)

**Адрес:** 198099, г. Санкт-Петербург, ул. Калинина, дом 2, корпус 4, литера А.