

## RONDA-WAS-C

Asymmetric beam for wall washing with holder  
C compatible with LEDiL HEKLA

### TECHNICAL SPECIFICATIONS:

Dimensions	Ø 53.9 mm
Height	24.7 mm
Fastening	socket
ROHS compliant	yes ⓘ

### MATERIAL SPECIFICATIONS:

Component	Type	Material	Colour	Finish
RONDA-WAS	Single lens	PMMA	clear	
RONDA-HLD-C	Holder	PC	white	

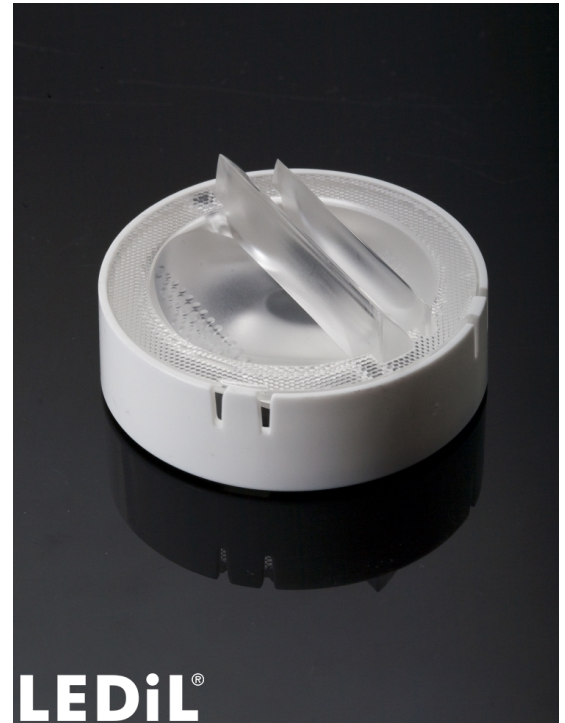



### ORDERING INFORMATION:

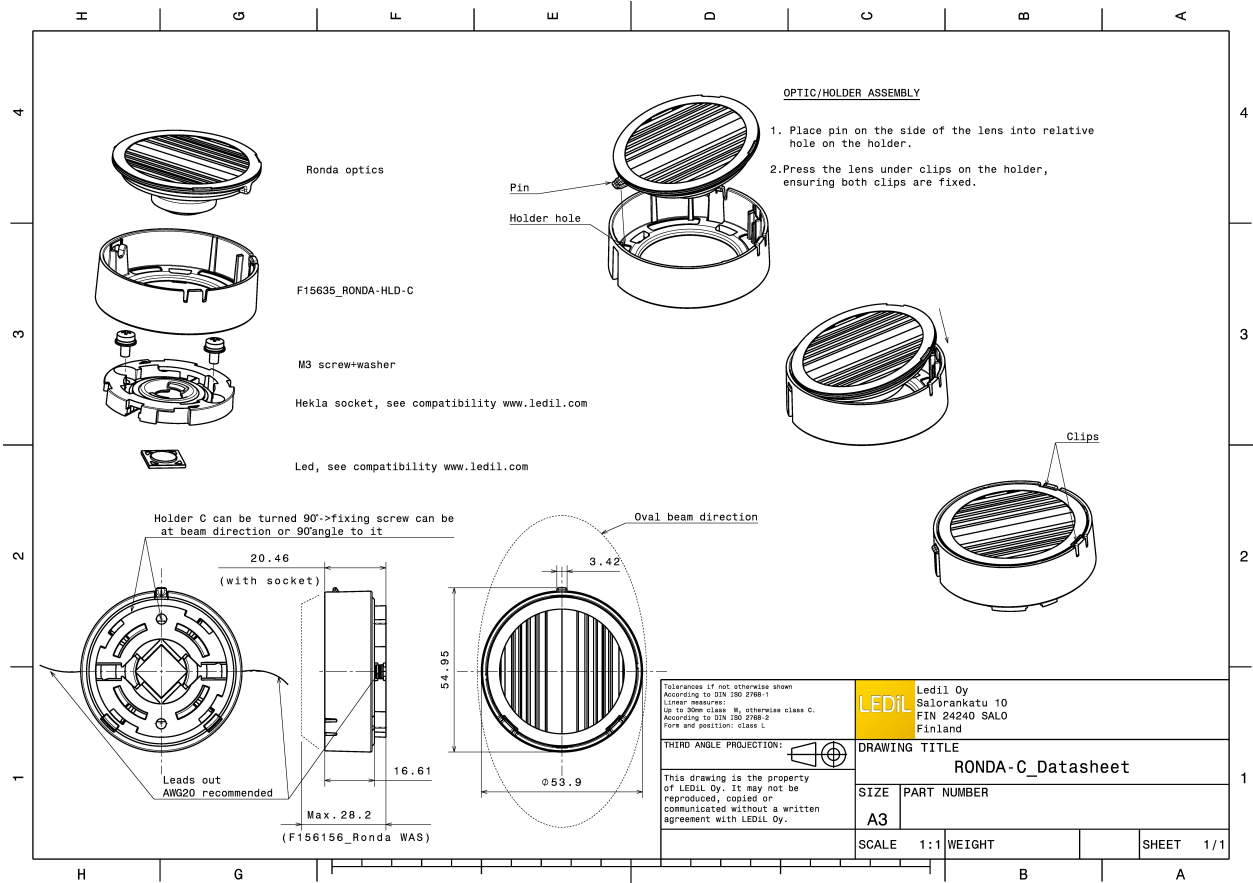

Component		Qty in box	MOQ	MPQ	Box weight (kg)
FN15971_RONDA-WAS-C	Single lens	420	120	30	0.0
» Box size:					

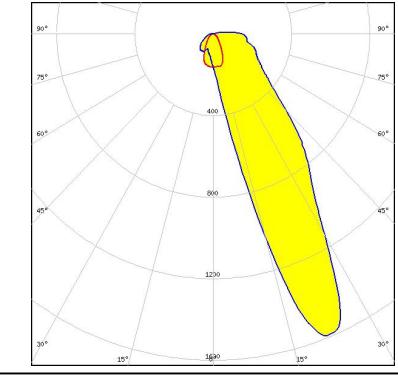

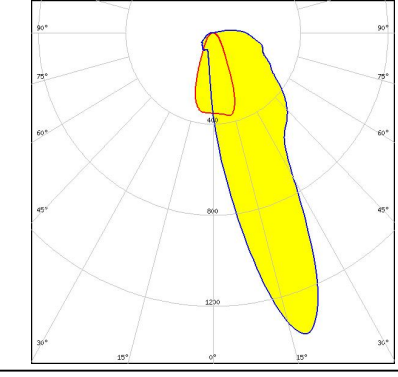
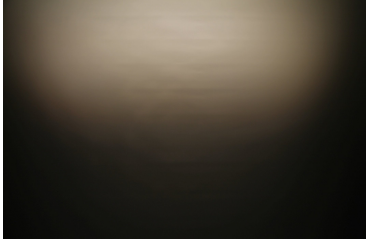
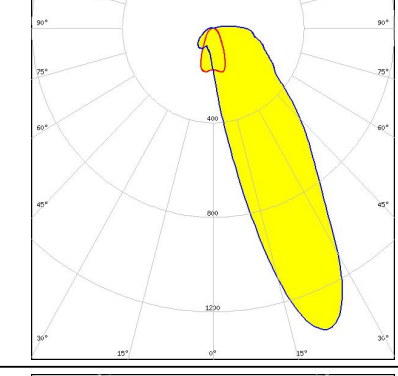
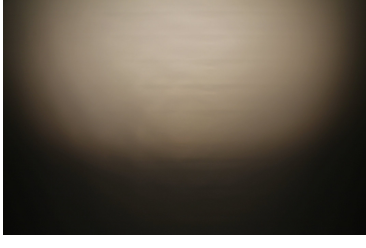
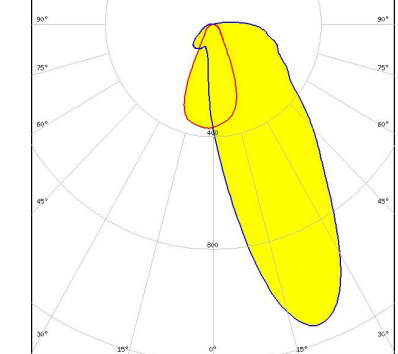
#### PHOTOMETRIC DATA (MEASURED):

<p>bridgelux.</p> <p>LED V4 HD</p> <p>FWHM Asymmetric</p> <p>Efficiency 92 %</p> <p>Peak intensity 1.6 cd/lm</p> <p>LEDs/each optic 1</p> <p>Light colour White</p> <p>Required components: F15253_HEKLA-SOCKET-A</p>		
<p>bridgelux.</p> <p>LED V6 Gen6</p> <p>FWHM Asymmetric</p> <p>Efficiency 90 %</p> <p>Peak intensity 1.4 cd/lm</p> <p>LEDs/each optic 1</p> <p>Light colour White</p> <p>Required components: F15253_HEKLA-SOCKET-A</p>		
<p>bridgelux.</p> <p>LED V6 HD</p> <p>FWHM Asymmetric</p> <p>Efficiency 91 %</p> <p>Peak intensity 1.4 cd/lm</p> <p>LEDs/each optic 1</p> <p>Light colour White</p> <p>Required components: F15255_HEKLA-SOCKET-C</p>		
<p>bridgelux.</p> <p>LED V9 HD</p> <p>FWHM Asymmetric</p> <p>Efficiency 90 %</p> <p>Peak intensity 1.2 cd/lm</p> <p>LEDs/each optic 1</p> <p>Light colour White</p> <p>Required components: F15859_HEKLA-SOCKET-I</p>		

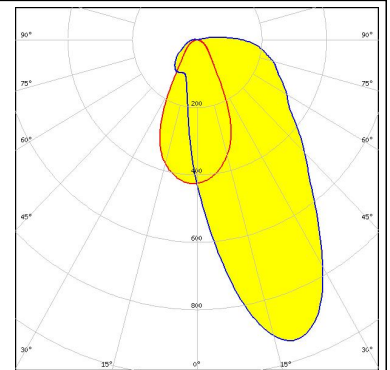
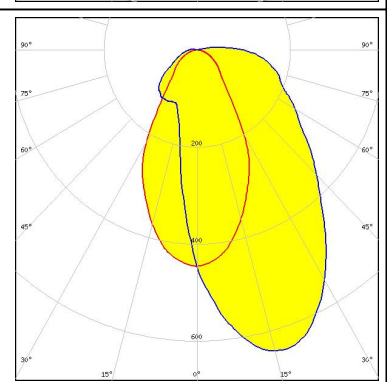
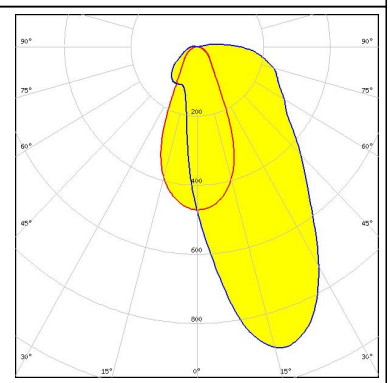
#### PHOTOMETRIC DATA (MEASURED):

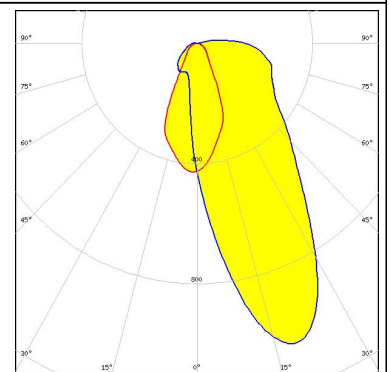
<p>bridgelux.</p> <p>LED VERO10</p> <p>FWHM Asymmetric</p> <p>Efficiency 89 %</p> <p>Peak intensity 1 cd/lm</p> <p>LEDs/each optic 1</p> <p>Light colour White</p> <p>Required components: F15616_HEKLA-SOCKET-F</p>		
<p>bridgelux.</p> <p>LED Vesta TW 13mm (25W) CSP</p> <p>FWHM Asymmetric</p> <p>Efficiency 83 %</p> <p>Peak intensity 0.6 cd/lm</p> <p>LEDs/each optic 1</p> <p>Light colour White</p> <p>Required components: C16142_HEKLA-SOCKET-K Bender Wirth: 492 Typ L8</p>		
<p>bridgelux.</p> <p>LED Vesta TW 9mm (12W) CSP</p> <p>FWHM Asymmetric</p> <p>Efficiency 85 %</p> <p>Peak intensity 0.9 cd/lm</p> <p>LEDs/each optic 1</p> <p>Light colour White</p> <p>Required components: C16142_HEKLA-SOCKET-K</p>		
<p><b>CITIZEN</b></p> <p>LED CLC020 Series (Dim-To-Warm)</p> <p>FWHM Asymmetric</p> <p>Efficiency 86 %</p> <p>Peak intensity 1.1 cd/lm</p> <p>LEDs/each optic 1</p> <p>Light colour White</p> <p>Required components: C16142_HEKLA-SOCKET-K</p>		

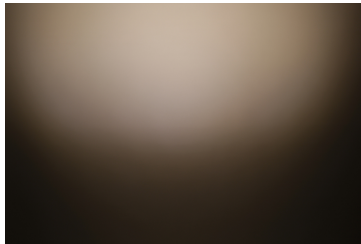



#### PHOTOMETRIC DATA (MEASURED):

#### CITIZEN

LED CLL02x/CLU02x (LES10)  
 FWHM Asymmetric  
 Efficiency 89 %  
 Peak intensity 1 cd/lm  
 LEDs/each optic 1  
 Light colour White  
 Required components:  
 F15255\_HEKLA-SOCKET-C

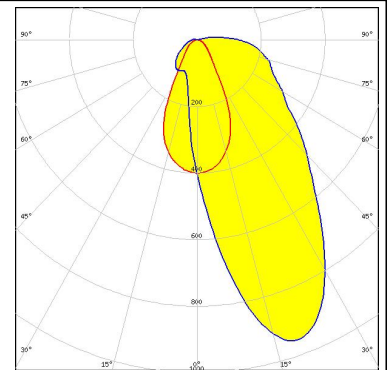

#### CITIZEN

LED CLL03x/CLU03x  
 FWHM Asymmetric  
 Efficiency 83 %  
 Peak intensity 0.6 cd/lm  
 LEDs/each optic 1  
 Light colour White  
 Required components:  
 F15859\_HEKLA-SOCKET-I

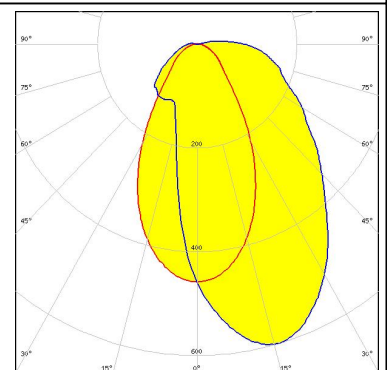

#### CITIZEN

LED CLU700/701/702  
 FWHM Asymmetric  
 Efficiency 90 %  
 Peak intensity 1.3 cd/lm  
 LEDs/each optic 1  
 Light colour White  
 Required components:  
 F15255\_HEKLA-SOCKET-C

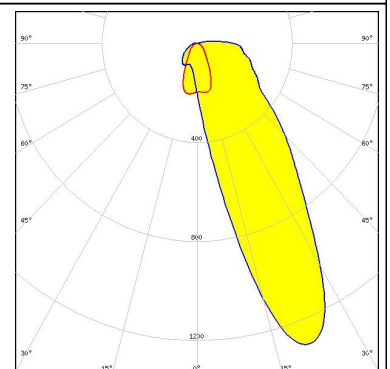

#### CITIZEN

LED CLU710/711  
 FWHM Asymmetric  
 Efficiency 87 %  
 Peak intensity 1 cd/lm  
 LEDs/each optic 1  
 Light colour White  
 Required components:  
 F15956\_HEKLA-SOCKET-J

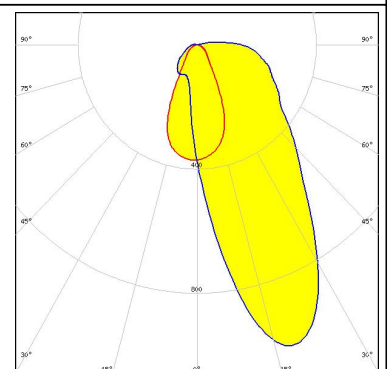

#### PHOTOMETRIC DATA (MEASURED):

#### CITIZEN

LED CLU7A2 (LES 4.2mm)  
 FWHM Asymmetric  
 Efficiency 91 %  
 Peak intensity 1.5 cd/lm  
 LEDs/each optic 1  
 Light colour White  
 Required components:  
 F15255\_HEKLA-SOCKET-C

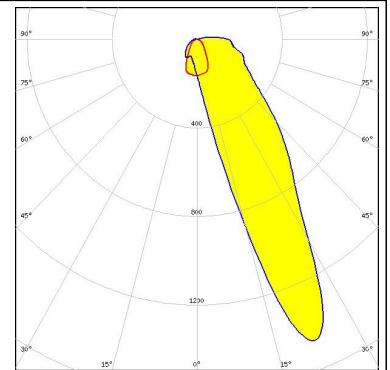

#### CITIZEN

LED LCN-C01B (Tunable White)  
 FWHM Asymmetric  
 Efficiency 87 %  
 Peak intensity 1.1 cd/lm  
 LEDs/each optic 1  
 Light colour White  
 Required components:  
 C16142\_HEKLA-SOCKET-K  
 Bender Wirth: 481 Typ L8

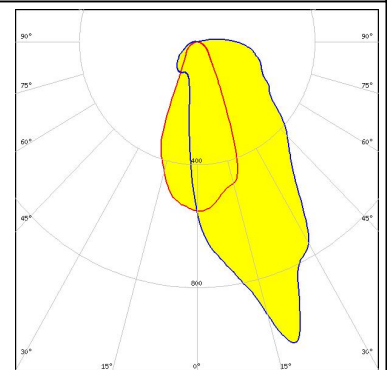

#### CREE

LED CMA1516  
 FWHM Asymmetric  
 Efficiency 92 %  
 Peak intensity 1 cd/lm  
 LEDs/each optic 1  
 Light colour White  
 Required components:  
 F15256\_HEKLA-SOCKET-D

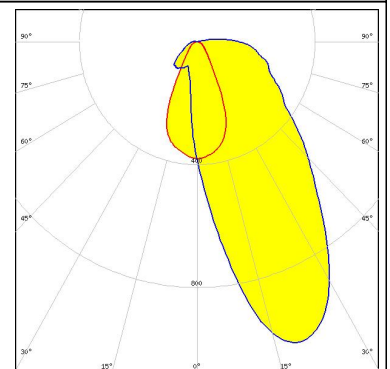
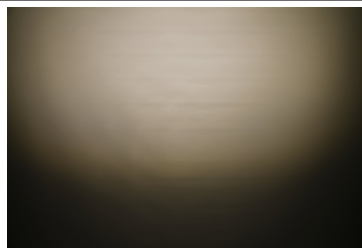

#### CREE

LED CMA1825  
 FWHM Asymmetric  
 Efficiency 90 %  
 Peak intensity 0.8 cd/lm  
 LEDs/each optic 1  
 Light colour White  
 Required components:  
 F15254\_HEKLA-SOCKET-B

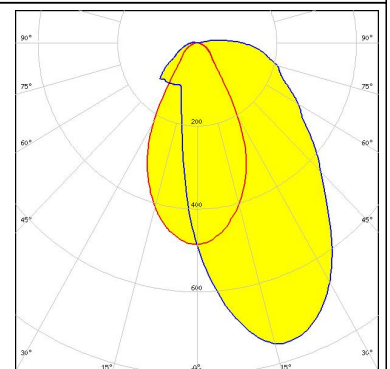
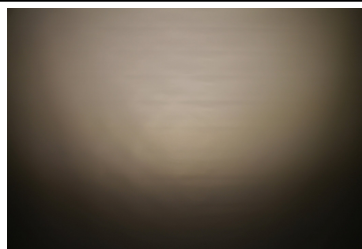

#### PHOTOMETRIC DATA (MEASURED):



LED CMT14xx  
 FWHM Asymmetric  
 Efficiency 91 %  
 Peak intensity 1 cd/lm  
 LEDs/each optic 1  
 Light colour White  
 Required components:  
 F15255\_HEKLA-SOCKET-C

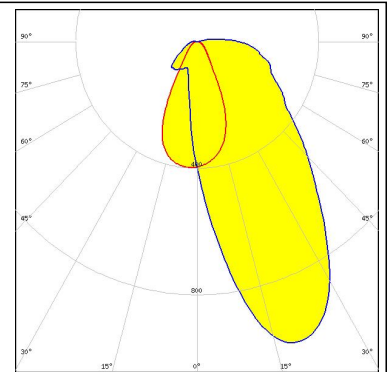
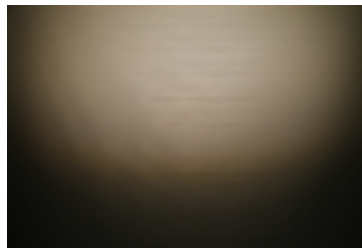

LED CMT19xx  
 FWHM Asymmetric  
 Efficiency 85 %  
 Peak intensity 0.6 cd/lm  
 LEDs/each optic 1  
 Light colour White  
 Required components:  
 F15859\_HEKLA-SOCKET-I

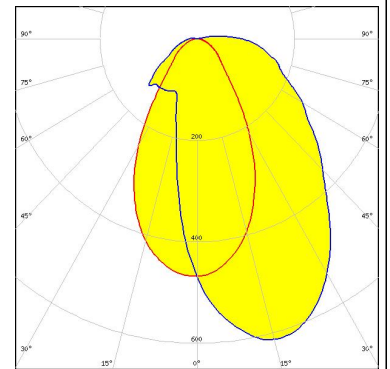

LED CXA/B 13xx  
 FWHM Asymmetric  
 Efficiency 91 %  
 Peak intensity 1.3 cd/lm  
 LEDs/each optic 1  
 Light colour White  
 Required components:  
 F15956\_HEKLA-SOCKET-J

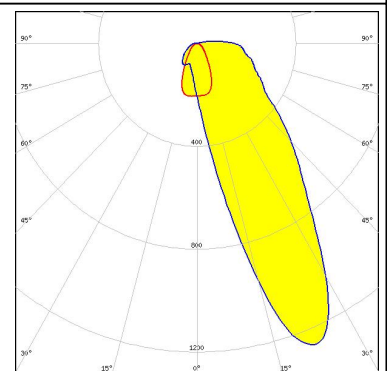
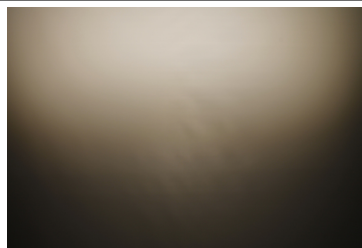

LED CXA/B 15xx  
 FWHM Asymmetric  
 Efficiency 91 %  
 Peak intensity 1 cd/lm  
 LEDs/each optic 1  
 Light colour White  
 Required components:  
 F15256\_HEKLA-SOCKET-D

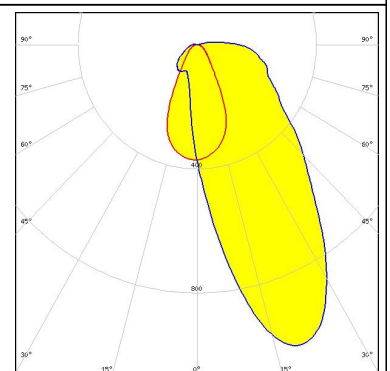

#### PHOTOMETRIC DATA (MEASURED):



LED CXA/B 1816 & CXA/B 1820 & CXA 1850  
 FWHM Asymmetric  
 Efficiency 87 %  
 Peak intensity 0.7 cd/lm  
 LEDs/each optic 1  
 Light colour White  
 Required components:  
 F15254\_HEKLA-SOCKET-B

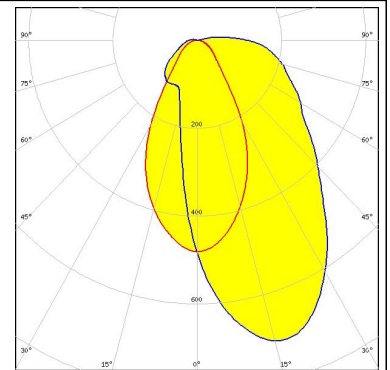

LED LUXEON CoB 1202HD  
 FWHM Asymmetric  
 Efficiency 92 %  
 Peak intensity 1.4 cd/lm  
 LEDs/each optic 1  
 Light colour White  
 Required components:  
 F15848\_HEKLA-SOCKET-G

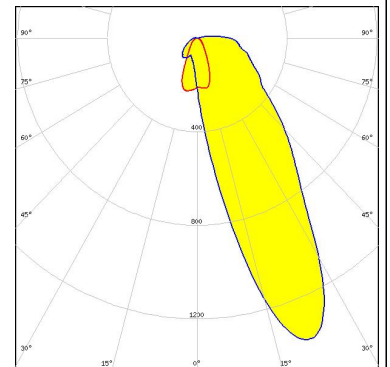
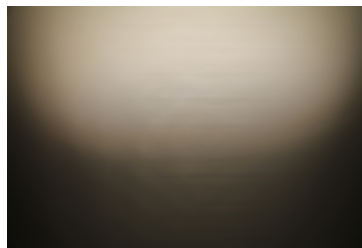

LED LUXEON CoB 1202s  
 FWHM Asymmetric  
 Efficiency 91 %  
 Peak intensity 1.3 cd/lm  
 LEDs/each optic 1  
 Light colour White  
 Required components:  
 F15848\_HEKLA-SOCKET-G

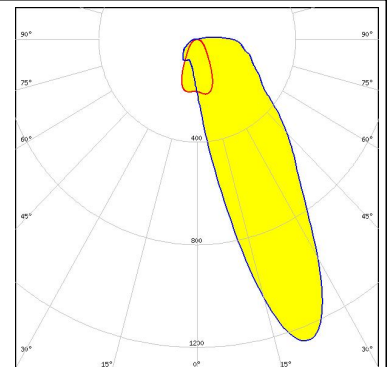

LED LUXEON CoB 1204HD  
 FWHM Asymmetric  
 Efficiency 91 %  
 Peak intensity 1.1 cd/lm  
 LEDs/each optic 1  
 Light colour White  
 Required components:  
 F15858\_HEKLA-SOCKET-H

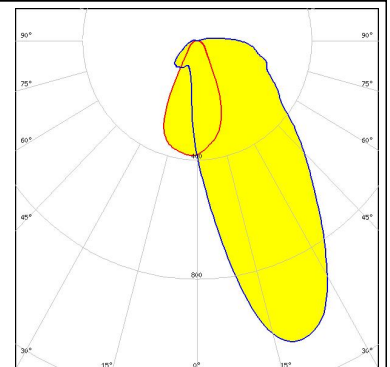
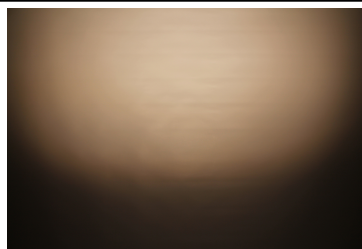

#### PHOTOMETRIC DATA (MEASURED):

#### LUMILEDS

LED LUXEON CoB 1205HD  
 FWHM Asymmetric  
 Efficiency 90 %  
 Peak intensity 0.9 cd/lm  
 LEDs/each optic 1  
 Light colour White  
 Required components:  
 F15858\_HEKLA-SOCKET-H

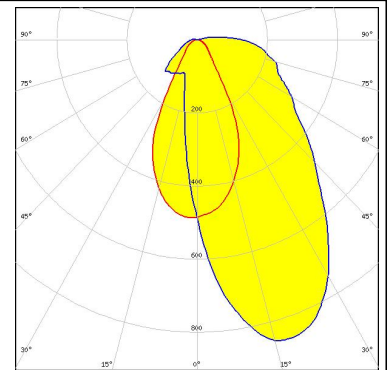

#### LUMILEDS

LED LUXEON CX Plus CoB - HD S01H4  
 FWHM Asymmetric  
 Efficiency 91 %  
 Peak intensity 1.4 cd/lm  
 LEDs/each optic 1  
 Light colour White  
 Required components:  
 Bender Wirth: 634c Hekla

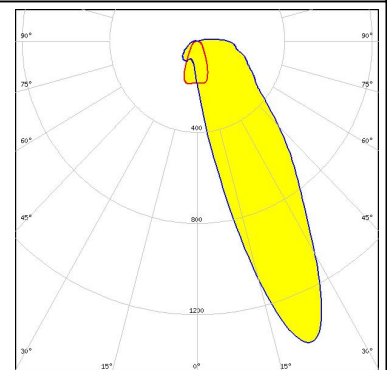

#### LUMILEDS

LED LUXEON CX Plus CoB - HD S01H6 / HD S02H6  
 FWHM Asymmetric  
 Efficiency 91 %  
 Peak intensity 1.4 cd/lm  
 LEDs/each optic 1  
 Light colour White  
 Required components:  
 Bender Wirth: 634c Hekla

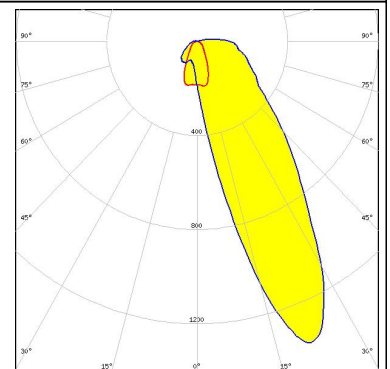

#### LUMILEDS

LED LUXEON CX Plus CoB - HD S04H9  
 FWHM Asymmetric  
 Efficiency 91 %  
 Peak intensity 1.1 cd/lm  
 LEDs/each optic 1  
 Light colour White  
 Required components:  
 Bender Wirth: 634c Hekla

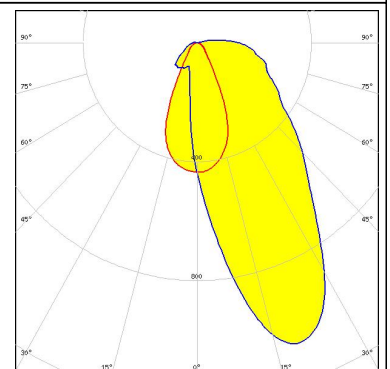

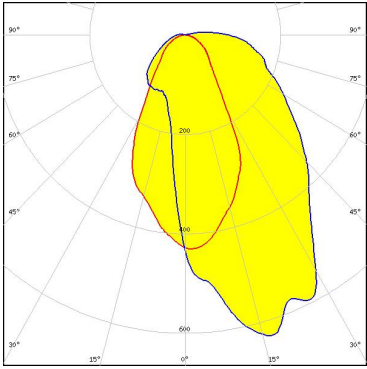
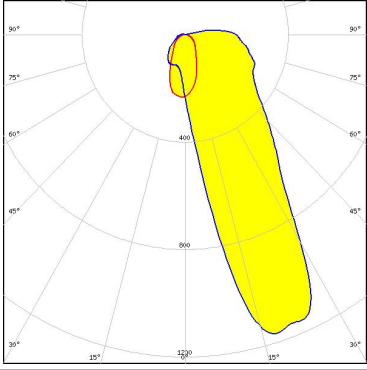
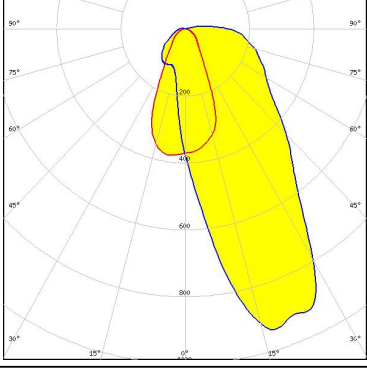
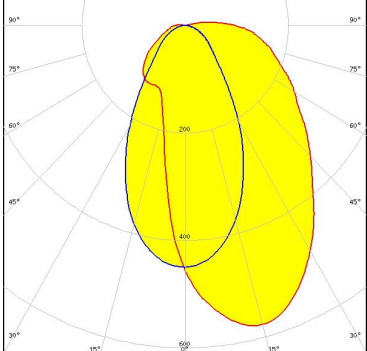

#### PHOTOMETRIC DATA (MEASURED):

<p><b>LUMINUS</b></p> <p>LED CDM-14 (Dim-To-Warm)</p> <p>FWHM Asymmetric</p> <p>Efficiency 80 %</p> <p>Peak intensity 0.6 cd/lm</p> <p>LEDs/each optic 1</p> <p>Light colour White</p> <p>Required components: C16142_HEKLA-SOCKET-K Bender Wirth: 491 Typ L8</p>	
<p><b>LUMINUS</b></p> <p>LED CDM-6 (Dim-To-Warm)</p> <p>FWHM Asymmetric</p> <p>Efficiency 82 %</p> <p>Peak intensity 1.2 cd/lm</p> <p>LEDs/each optic 1</p> <p>Light colour White</p> <p>Required components: C16142_HEKLA-SOCKET-K Bender Wirth: 490 Typ L8</p>	
<p><b>LUMINUS</b></p> <p>LED CDM-9 (Dim-To-Warm)</p> <p>FWHM Asymmetric</p> <p>Efficiency 85 %</p> <p>Peak intensity 0.9 cd/lm</p> <p>LEDs/each optic 1</p> <p>Light colour White</p> <p>Required components: C16142_HEKLA-SOCKET-K Bender Wirth: 490 Typ L8</p>	
<p><b>LUMINUS</b></p> <p>LED CxM-14 (19x19)</p> <p>FWHM Asymmetric</p> <p>Efficiency 82 %</p> <p>Peak intensity 0.6 cd/lm</p> <p>LEDs/each optic 1</p> <p>Light colour White</p> <p>Required components: F15859_HEKLA-SOCKET-I</p>	



#### PHOTOMETRIC DATA (MEASURED):



**LED** CXM-4  
**FWHM** Asymmetric  
**Efficiency** 90 %  
**Peak intensity** 1.4 cd/lm  
**LEDs/each optic** 1  
**Light colour** White  
**Required components:**  
 F15255\_HEKLA-SOCKET-C

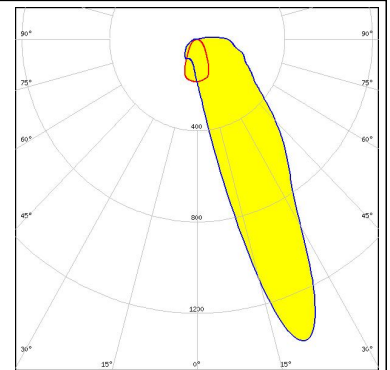

**LED** CxM-9 (13.5x13.5)  
**FWHM** Asymmetric  
**Efficiency** 89 %  
**Peak intensity** 1 cd/lm  
**LEDs/each optic** 1  
**Light colour** White  
**Required components:**  
 F15255\_HEKLA-SOCKET-C

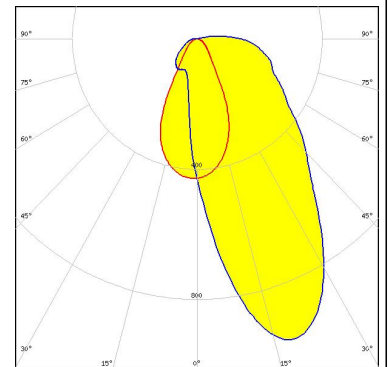

**LED** NJCWL024Z-V1MT: COB L-Type Tunable White  
**FWHM** Asymmetric  
**Efficiency** 83 %  
**Peak intensity** 1.2 cd/lm  
**LEDs/each optic** 1  
**Light colour** White  
**Required components:**  
 C16142\_HEKLA-SOCKET-K  
 Bender Wirth: 497 Typ L8

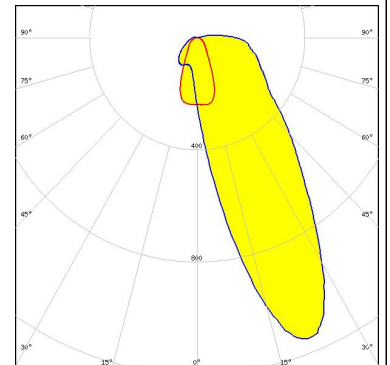

**LED** NVCWJ024Z-V1MT: COB J-Type Tunable White  
**FWHM** Asymmetric  
**Efficiency** 86 %  
**Peak intensity** 0.9 cd/lm  
**LEDs/each optic** 1  
**Light colour** White  
**Required components:**  
 C16142\_HEKLA-SOCKET-K  
 Bender Wirth: 498 Typ L8

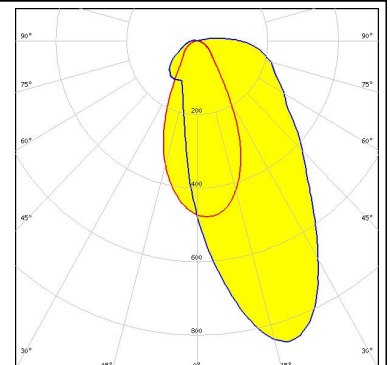

#### PHOTOMETRIC DATA (MEASURED):

### PHILIPS

LED Fortimo SLM L09 CoB  
 FWHM Asymmetric  
 Efficiency 91 %  
 Peak intensity 1 cd/lm  
 LEDs/each optic 1  
 Light colour White  
 Required components:  
 F15858\_HEKLA-SOCKET-H

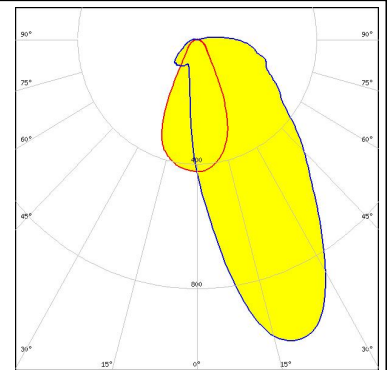

### PHILIPS

LED Fortimo SLM L13 CoB  
 FWHM Asymmetric  
 Efficiency 84 %  
 Peak intensity 0.6 cd/lm  
 LEDs/each optic 1  
 Light colour White  
 Required components:  
 C16142\_HEKLA-SOCKET-K  
 Bender Wirth: 432 Typ L8

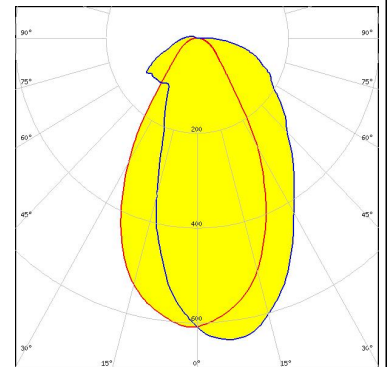

### SAMSUNG

LED LC003D / LC006D / LC009D / LC013D  
 FWHM Asymmetric  
 Efficiency 90 %  
 Peak intensity 1 cd/lm  
 LEDs/each optic 1  
 Light colour White  
 Required components:

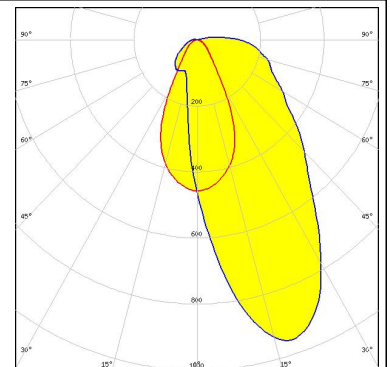
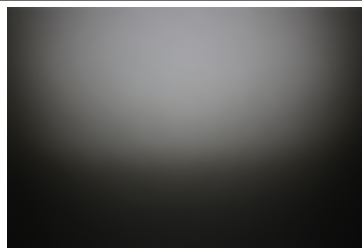

### SAMSUNG

LED LC010C  
 FWHM Asymmetric  
 Efficiency 90 %  
 Peak intensity 1.1 cd/lm  
 LEDs/each optic 1  
 Light colour White  
 Required components:  
 F15848\_HEKLA-SOCKET-G

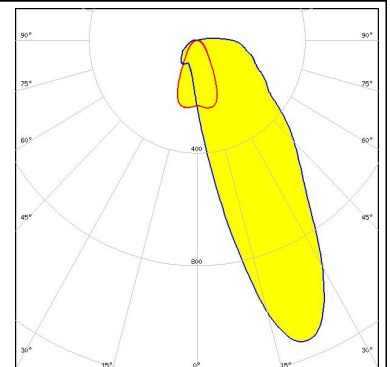

#### PHOTOMETRIC DATA (MEASURED):

#### SAMSUNG

LED LC010C G2  
 FWHM Asymmetric  
 Efficiency 88 %  
 Peak intensity 1.5 cd/lm  
 LEDs/each optic 1  
 Light colour White  
 Required components:  
 F15255\_HEKLA-SOCKET-C

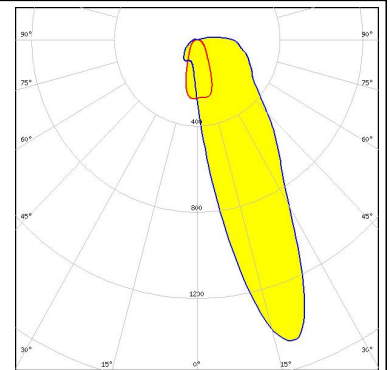

#### SAMSUNG

LED LC016D / LC019D / LC026D / LC033D  
 FWHM Asymmetric  
 Efficiency 83 %  
 Peak intensity 0.6 cd/lm  
 LEDs/each optic 1  
 Light colour White  
 Required components:  
 F15859\_HEKLA-SOCKET-I

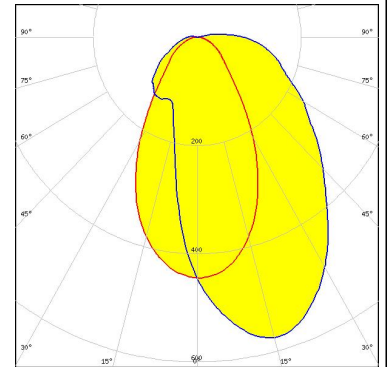

#### SAMSUNG

LED LC020C  
 FWHM Asymmetric  
 Efficiency 90 %  
 Peak intensity 1 cd/lm  
 LEDs/each optic 1  
 Light colour White  
 Required components:  
 F15848\_HEKLA-SOCKET-G

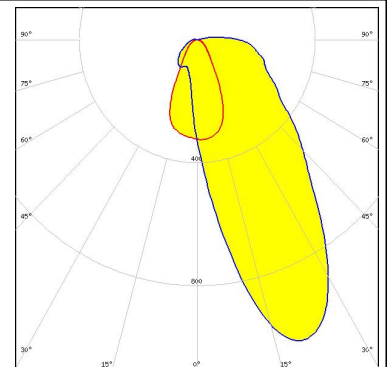

#### SAMSUNG

LED LC020C G2  
 FWHM Asymmetric  
 Efficiency 89 %  
 Peak intensity 1 cd/lm  
 LEDs/each optic 1  
 Light colour White  
 Required components:  
 F15859\_HEKLA-SOCKET-I

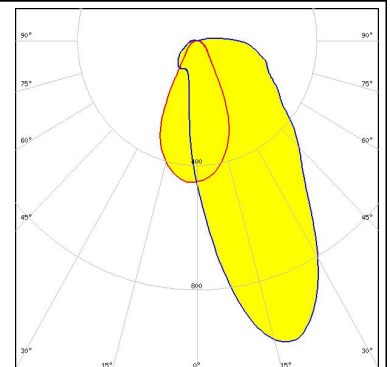

#### PHOTOMETRIC DATA (MEASURED):

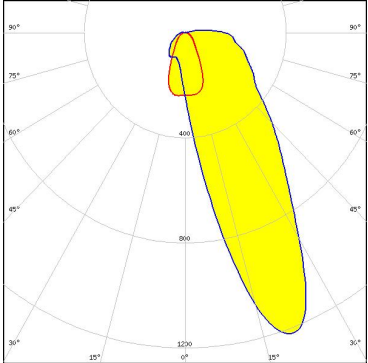
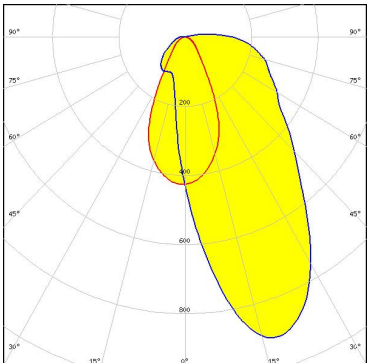
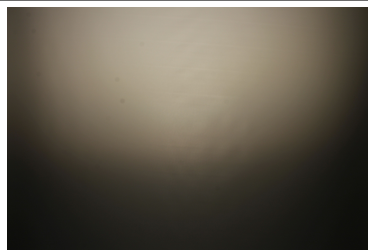
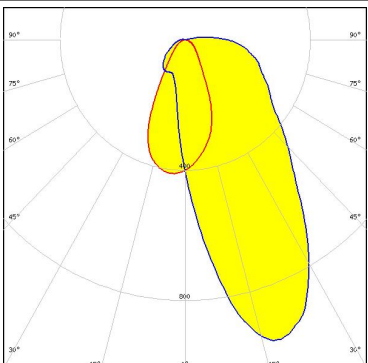
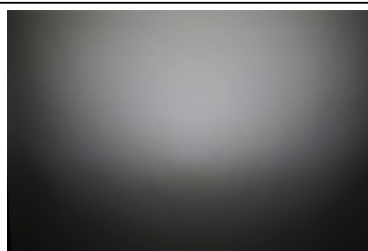
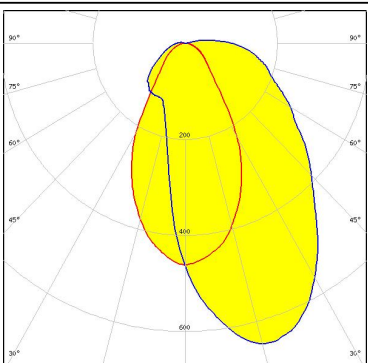
<p><b>SEOL</b> SEOUL SEMICONDUCTOR</p> <p>LED MJT COB LES 6 FWHM Asymmetric Efficiency 88 % Peak intensity 1.2 cd/lm LEDs/each optic 1 Light colour White Required components: F15255_HEKLA-SOCKET-C</p>		
<p><b>SEOL</b> SEOUL SEMICONDUCTOR</p> <p>LED MJT COB LES 9.8 FWHM Asymmetric Efficiency 88 % Peak intensity 0.9 cd/lm LEDs/each optic 1 Light colour White Required components: F15255_HEKLA-SOCKET-C</p>		
<p><b>TRIDONIC</b></p> <p>LED SLE G7 LES09 FWHM Asymmetric Efficiency 89 % Peak intensity 1 cd/lm LEDs/each optic 1 Light colour White Required components: F15255_HEKLA-SOCKET-C</p>		
<p><b>TRIDONIC</b></p> <p>LED SLE G7 LES13 FWHM Asymmetric Efficiency 85 % Peak intensity 0.7 cd/lm LEDs/each optic 1 Light colour White Required components: F15859_HEKLA-SOCKET-I</p>		

#### PHOTOMETRIC DATA (MEASURED):

#### TRIDONIC

LED SLE G7 LES15  
FWHM Asymmetric  
Efficiency 82 %  
Peak intensity 0.5 cd/lm  
LEDs/each optic 1  
Light colour White  
Required components:  
F15859\_HEKLA-SOCKET-I

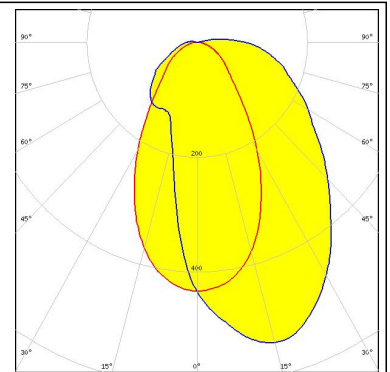

#### XICATO

LED XOB 14.5 mm  
FWHM Asymmetric  
Efficiency 83 %  
Peak intensity 0.6 cd/lm  
LEDs/each optic 1  
Light colour White  
Required components:  
F15859\_HEKLA-SOCKET-I

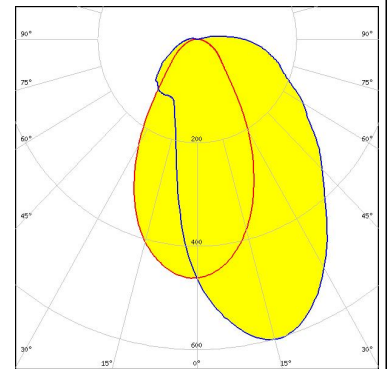

#### XICATO

LED XOB 9.8 mm  
FWHM Asymmetric  
Efficiency 90 %  
Peak intensity 1 cd/lm  
LEDs/each optic 1  
Light colour White  
Required components:  
F15255\_HEKLA-SOCKET-C

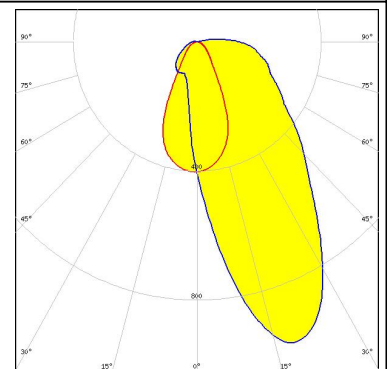
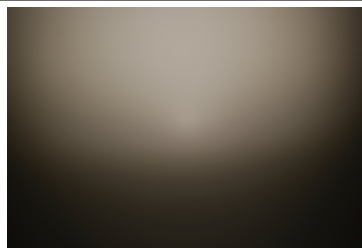

#### XICATO

LED XTM - 19mm LES  
FWHM Asymmetric  
Efficiency 83 %  
Peak intensity 0.5 cd/lm  
LEDs/each optic 1  
Light colour White  
Required components:  
C16058\_XTM-ADAPTER-50-C

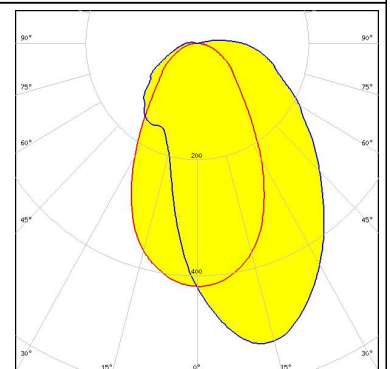
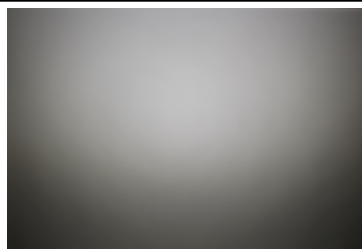

#### PHOTOMETRIC DATA (SIMULATED):

##### LUMILEDS

LED LUXEON CoB L04/L05  
FWHM Asymmetric  
Efficiency 86 %  
Peak intensity 0.8 cd/lm  
LEDs/each optic 1  
Light colour White  
Required components:  
F15254\_HEKLA-SOCKET-B

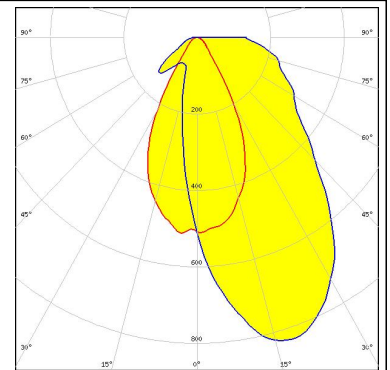

##### LUMILEDS

LED LUXEON CoB L08  
FWHM Asymmetric  
Efficiency 78 %  
Peak intensity 0.6 cd/lm  
LEDs/each optic 1  
Light colour White  
Required components:  
C16142\_HEKLA-SOCKET-K  
Bender Wirth: 457 Typ L8

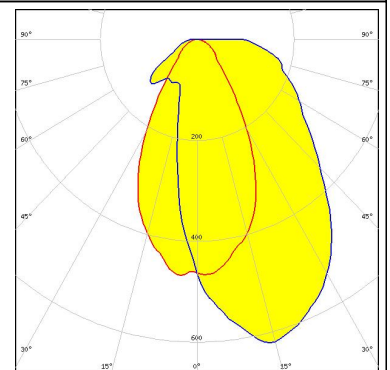

##### LUMILEDS

LED LUXEON CoB M02/M03  
FWHM Asymmetric  
Efficiency 89 %  
Peak intensity 1.2 cd/lm  
LEDs/each optic 1  
Light colour White  
Required components:  
F15256\_HEKLA-SOCKET-D

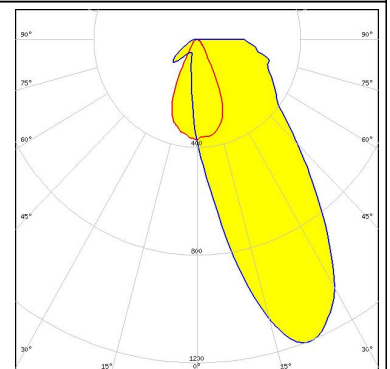

##### LUMILEDS

LED LUXEON CoB S01  
FWHM Asymmetric  
Efficiency 90 %  
Peak intensity 1.6 cd/lm  
LEDs/each optic 1  
Light colour White  
Required components:  
F15956\_HEKLA-SOCKET-J



#### PHOTOMETRIC DATA (SIMULATED):



LED	COB T-Type
FWHM	Asymmetric
Efficiency	83 %
Peak intensity	1.4 cd/lm
LEDs/each optic	1
Light colour	White
Required components:	
F15848_HEKLA-SOCKET-G	

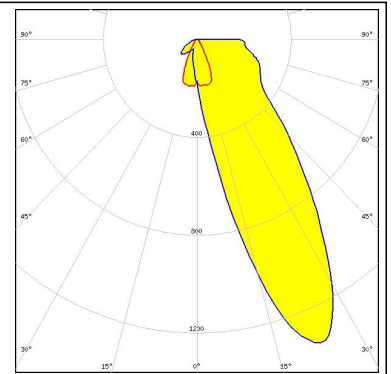

#### GENERAL INFORMATION:

NOTE: The typical beam angle will be changed by different color, chip size and chip position tolerance. The typical total beam angle is the full angle measured where the luminous intensity is half of the peak value.

Due to use of high power COB's with this product, special attention to proper thermal design is highly recommended. LEDiL has no liability for direct, indirect or consecutive damages arising from the LEDiL products being used outside of the recommended temperature range.

#### MATERIALS:

As part of our continuous research and improvement processes, and to ensure the best possible quality and availability of our products, LEDiL reserves the right to change material grades without notice.

#### PRODUCT DATA USER AGREEMENT AND DISCLAIMER:

The measured data in the provided downloadable LEDiL Product Datasheets and Mechanical 2D-Drawings is rounded and provided as reference for planning. LEDiL Oy's optical specifications have been verified by conducting performance testing of the products in accordance with the company's quality system. The reported data are averaged results of multiple measurements with typical variation. LEDiL Oy reserves the right to without prior notification make changes and improvements to its products.

LEDiL Oy assumes neither warranty, nor guarantee nor any other liability of any kind for the contents and correctness of the provided data. The provided data has been generated with highest diligence but the provided data may in reality not represent the complete possible variation range of all intrinsic parameters. Therefore, in certain cases a deviation from the provided data could occur.

LEDiL Oy reserves the right to undertake technical changes of its products without further notification which could lead to changes in the provided data. LEDiL Oy assumes no liability of any kind for the possible deviation from any provided data or any other damage resulting from the usage of the provided data.

The user agrees to this disclaimer and user agreement with the download or usage of the provided files.

#### LEDiL Oy

Joensuunkatu 13  
FI-24240 SALO  
Finland

#### LEDiL Inc.

228 West Page Street  
Suite D  
Sycamore IL 60178  
USA

#### Local sales and technical support

[www.ledil.com/where\\_to\\_buy](http://www.ledil.com/where_to_buy)

#### Shipping locations

Salo, Finland  
Hong Kong, China

#### Distribution Partners

[www.ledil.com/where\\_to\\_buy](http://www.ledil.com/where_to_buy)



Компания «ЭлектроПласт» предлагает заключение долгосрочных отношений при поставках импортных электронных компонентов на взаимовыгодных условиях!

Наши преимущества:

- Оперативные поставки широкого спектра электронных компонентов отечественного и импортного производства напрямую от производителей и с крупнейших мировых складов;
- Поставка более 17-ти миллионов наименований электронных компонентов;
- Поставка сложных, дефицитных, либо снятых с производства позиций;
- Оперативные сроки поставки под заказ (от 5 рабочих дней);
- Экспресс доставка в любую точку России;
- Техническая поддержка проекта, помощь в подборе аналогов, поставка прототипов;
- Система менеджмента качества сертифицирована по Международному стандарту ISO 9001;
- Лицензия ФСБ на осуществление работ с использованием сведений, составляющих государственную тайну;
- Поставка специализированных компонентов (Xilinx, Altera, Analog Devices, Intersil, Interpoint, Microsemi, Aeroflex, Peregrine, Syfer, Eurofarad, Texas Instrument, Miteq, Cobham, E2V, MA-COM, Hittite, Mini-Circuits, General Dynamics и др.);

Помимо этого, одним из направлений компании «ЭлектроПласт» является направление «Источники питания». Мы предлагаем Вам помощь Конструкторского отдела:

- Подбор оптимального решения, техническое обоснование при выборе компонента;
- Подбор аналогов;
- Консультации по применению компонента;
- Поставка образцов и прототипов;
- Техническая поддержка проекта;
- Защита от снятия компонента с производства.



#### Как с нами связаться

**Телефон:** 8 (812) 309 58 32 (многоканальный)

**Факс:** 8 (812) 320-02-42

**Электронная почта:** [org@eplast1.ru](mailto:org@eplast1.ru)

**Адрес:** 198099, г. Санкт-Петербург, ул. Калинина, дом 2, корпус 4, литера А.