



ELCO EUROPE (A DIVISION OF AVX LTD.) CONFIDENTIAL PROPRIETARY  
 THE DRAWING ON THIS PRINT AND INFORMATION THEREWITH ARE  
 PROPRIETARY TO ELCO EUROPE (A DIVISION OF AVX LTD.) AND  
 SHALL NOT BE USED OR DISCUSSED IN WHOLE OR IN PART  
 WITHOUT ELCO EUROPE'S WRITTEN CONSENT.

XX-9159-XXX-101-X16

PREFIX \_\_\_\_\_

CODE	TYPE
10	PLUG
20	SOCKET

**PRELIMINARY**  
 FOR INFORMATION ONLY

SERIES \_\_\_\_\_

NO. OF WAYS \_\_\_\_\_

CODE	NO. OF WAYS	PLUG DETAILS	SOCKET DETAILS
002	2	SHEET 2	SHEET 7
003	3	SHEET 3	SHEET 8
004	4	SHEET 4	SHEET 9
005	5	SHEET 5	SHEET 10
006	6	SHEET 6	SHEET 11

2 PART PCB STRIP CONNECTOR \_\_\_\_\_

CODE	DESCRIPTION
1	2 PART PCB STRIP CONNECTOR

CONNECTOR PITCH \_\_\_\_\_

CODE	PITCH
01	3mm

INSULATOR COLOUR \_\_\_\_\_

CODE	COLOUR	AVAILABILITY
0	BLACK	OPTIONAL
1	WHITE	STANDARD

PLATING OPTION \_\_\_\_\_

CODE	CONTACT	BRACKET
16	GOLD IN CONTACT AREA TIN ON SOLDER TAIL	TIN ALL OVER

SHEET 1 OF 11

FORM-106-01-056-6 ISS 7

Release No.  
 History  
 102559

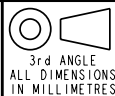

© COPYRIGHT ELCO EUROPE  
 NOT TO BE DISCLOSED OR COPIED  
 WITHOUT WRITTEN PERMISSION

Drawn  
 N.C.H.  
 Size  
 CV

Description  
 9159 TWO PART - ORDERING CODE

Part Number  
 00-9159-01\_100S

DATE  
 06-Sept-04  
 Issue  
 C

# PLUG 2 WAY 2 PART PCB STRIP CONNECTOR

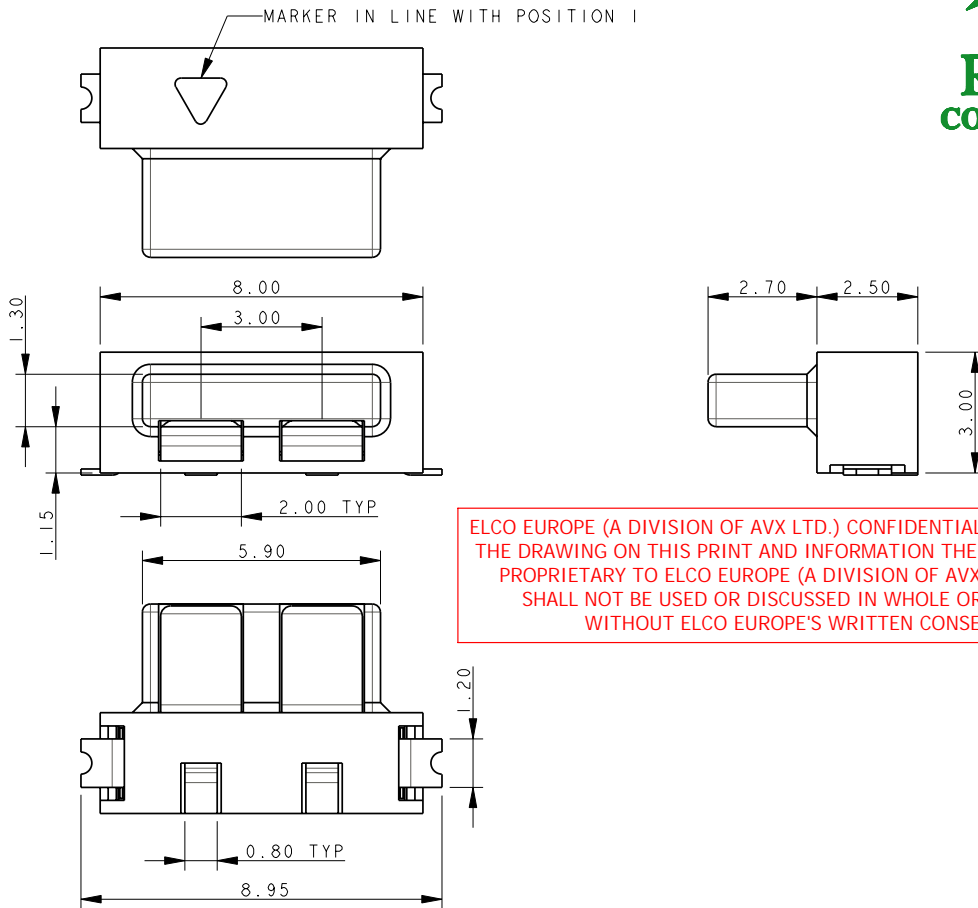

ELCO EUROPE (A DIVISION OF AVX LTD.) CONFIDENTIAL PROPRIETARY THE DRAWING ON THIS PRINT AND INFORMATION THEREWITH ARE PROPRIETARY TO ELCO EUROPE (A DIVISION OF AVX LTD.) AND SHALL NOT BE USED OR DISCUSSED IN WHOLE OR IN PART WITHOUT ELCO EUROPE'S WRITTEN CONSENT.

- NOTES:
1. FOR MORE INFORMATION REFER TO PRODUCT SPEC 201-01-119.
  2. DIMENSIONS ARE REFERENCE DIMENSIONS UNLESS TOLERANCED.
  3. INSULATOR MATERIAL :- NYLON 46, COLOUR REFER TO SHEET 1.
  4. CONTACT MATERIAL :- COPPER ALLOY, SELECTIVE GOLD OVER NICKEL TIN PLATED ON TAILS.
  5. BRACKETS :- COPPER ALLOY, TIN PLATED.
  6. OUTLINE OF CONNECTOR.
  7. PACKING TAPE AND REEL, QUANTITY 1400 PER REEL.

## 2 WAY PCB BOARD LAYOUT

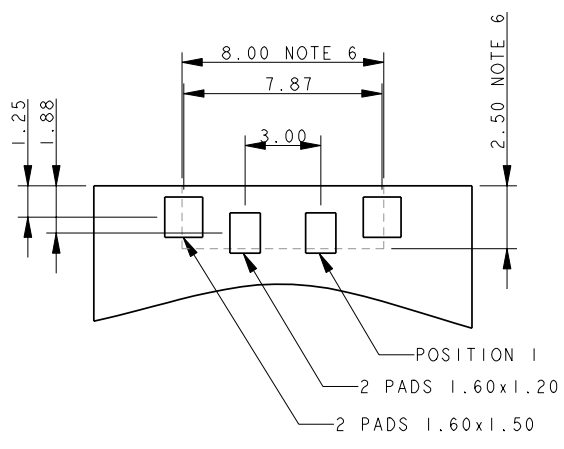

## PACKING DETAILS TBC

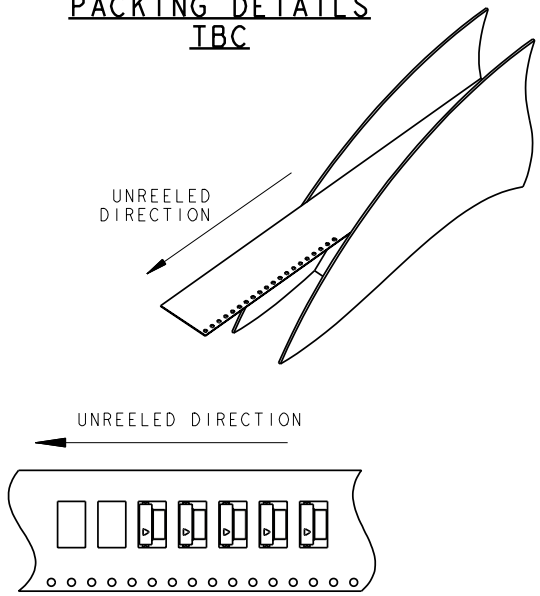

SHEET 2 TO 11

FORM-106-01-056-6 ISS 7

Release No.  
History  
102559

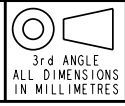

ELCO

© COPYRIGHT ELCO EUROPE  
NOT TO BE DISCLOSED OR COPIED  
WITHOUT WRITTEN PERMISSION

Drawn  
N.C.H.  
  
Size  
CV

Description	DATE
9159 TWO PART - ORDERING CODE	06-Sept-04
Part Number	Issue
00-9159-01_100S	C

A

B

# PLUG 3 WAY 2 PART PCB STRIP CONNECTOR

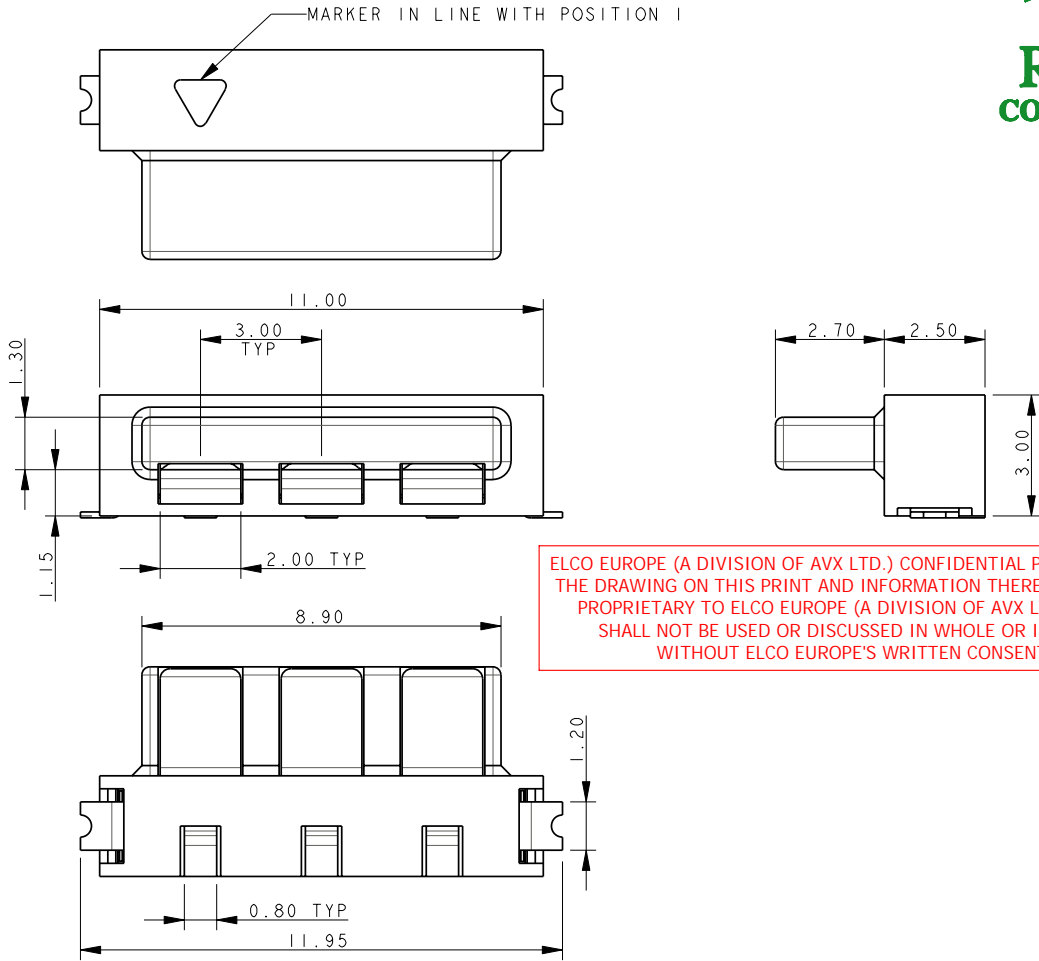

ELCO EUROPE (A DIVISION OF AVX LTD.) CONFIDENTIAL PROPRIETARY THE DRAWING ON THIS PRINT AND INFORMATION THEREWITH ARE PROPRIETARY TO ELCO EUROPE (A DIVISION OF AVX LTD.) AND SHALL NOT BE USED OR DISCUSSED IN WHOLE OR IN PART WITHOUT ELCO EUROPE'S WRITTEN CONSENT.

- NOTES:
1. FOR MORE INFORMATION REFER TO PRODUCT SPEC 201-01-119.
  2. DIMENSIONS ARE REFERENCE DIMENSIONS UNLESS TOLERANCED.
  3. INSULATOR MATERIAL :- NYLON 46, COLOUR REFER TO SHEET 1.
  4. CONTACT MATERIAL :- COPPER ALLOY, SELECTIVE GOLD OVER NICKEL TIN PLATED ON TAILS.
  5. BRACKETS :- COPPER ALLOY, TIN PLATED.
  6. OUTLINE OF CONNECTOR.
  7. PACKING TAPE AND REEL, QUANTITY 1400 PER REEL.

### 3 WAY BOARD LAYOUT

### PACKING DETAILS TBC

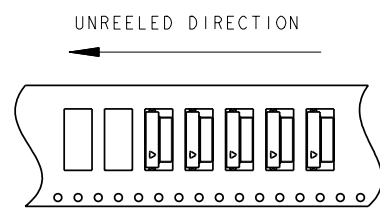
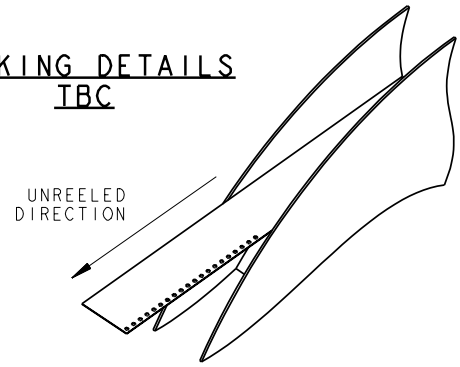
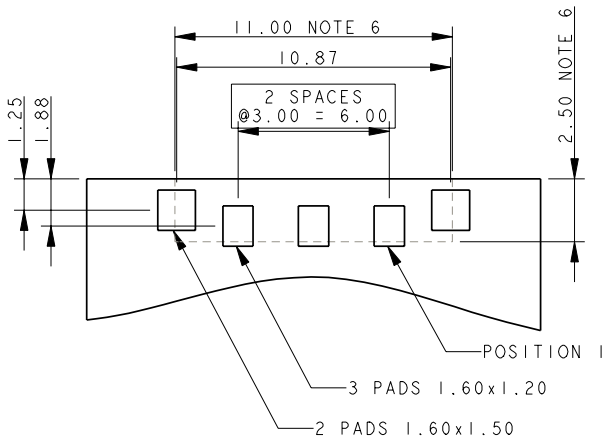

FORM-106-01-056-6 ISS 7

Release No.  
History  
102559



ELCO

© COPYRIGHT ELCO EUROPE  
NOT TO BE DISCLOSED OR COPIED  
WITHOUT WRITTEN PERMISSION

Drawn  
N.C.H.  
  
Size  
CV

Description 9159 TWO PART - ORDERING CODE	DATE 06-Sept-04
Part Number 00-9159-01_100S	Issue C

# PLUG 4 WAY 2 PART PCB STRIP CONNECTOR

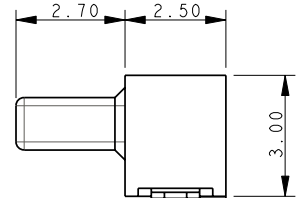
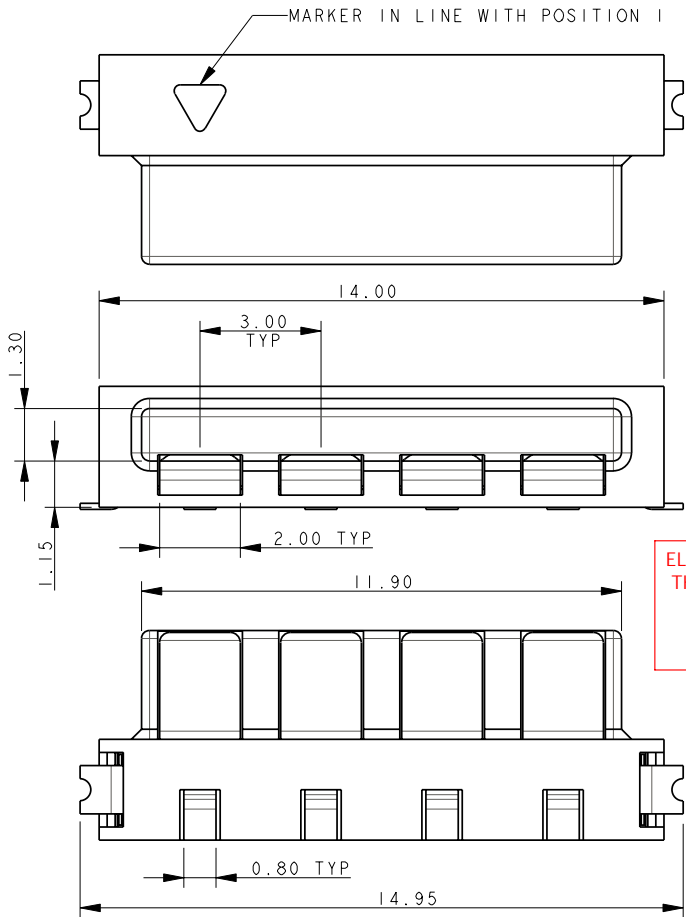

ELCO EUROPE (A DIVISION OF AVX LTD.) CONFIDENTIAL PROPRIETARY THE DRAWING ON THIS PRINT AND INFORMATION THEREWITH ARE PROPRIETARY TO ELCO EUROPE (A DIVISION OF AVX LTD.) AND SHALL NOT BE USED OR DISCUSSED IN WHOLE OR IN PART WITHOUT ELCO EUROPE'S WRITTEN CONSENT.

**NOTES:**

1. FOR MORE INFORMATION REFER TO PRODUCT SPEC 201-01-119.
2. DIMENSIONS ARE REFERENCE DIMENSIONS UNLESS TOLERANCED.
3. INSULATOR MATERIAL :- NYLON 46, COLOUR REFER TO SHEET 1.
4. CONTACT MATERIAL :- COPPER ALLOY, SELECTIVE GOLD OVER NICKEL TIN PLATED ON TAILS.
5. BRACKETS :- COPPER ALLOY, TIN PLATED.
6. OUTLINE OF CONNECTOR.
7. PACKING TAPE AND REEL, QUANTITY 1400 PER REEL.

**PACKING DETAILS**  
**TBC**

**4 WAY PCB BOARD LAYOUT**

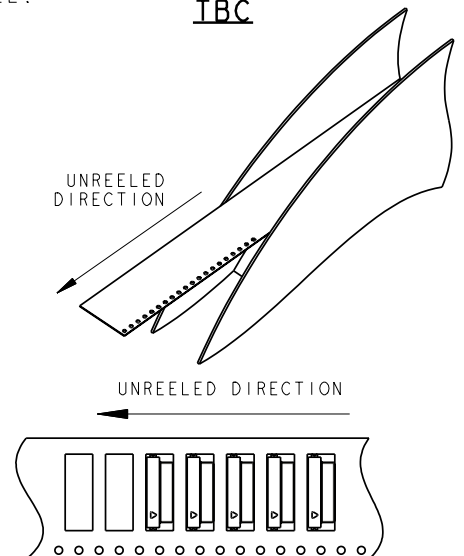
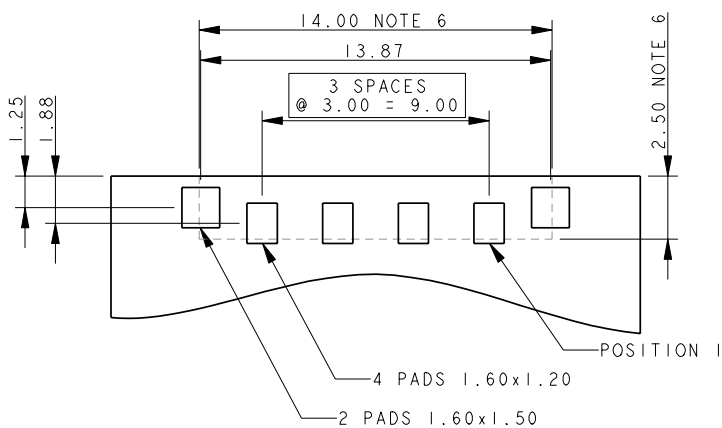

FORM-106-01-056-6 ISS 7

Release No.  
History  
102559

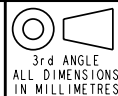

**ELCO**  
© COPYRIGHT ELCO EUROPE  
NOT TO BE DISCLOSED OR COPIED  
WITHOUT WRITTEN PERMISSION

Drawn  
N.C.H.  
  
Size  
**CV**

Description  
9159 TWO PART - ORDERING CODE  
  
Part Number  
00-9159-01\_100S

DATE  
09-Sep-08  
  
Issue  
**C**

A

B

# PLUG 5 WAY 2 PART PCB STRIP CONNECTOR



ELCO EUROPE (A DIVISION OF AVX LTD.) CONFIDENTIAL PROPRIETARY THE DRAWING ON THIS PRINT AND INFORMATION THEREWITH ARE PROPRIETARY TO ELCO EUROPE (A DIVISION OF AVX LTD.) AND SHALL NOT BE USED OR DISCUSSED IN WHOLE OR IN PART WITHOUT ELCO EUROPE'S WRITTEN CONSENT.

**NOTES:**

1. FOR MORE INFORMATION REFER TO PRODUCT SPEC 201-01-119.
2. DIMENSIONS ARE REFERENCE DIMENSIONS UNLESS TOLERANCED.
3. INSULATOR MATERIAL :- NYLON 46, COLOUR REFER TO SHEET 1.
4. CONTACT MATERIAL :- COPPER ALLOY, SELECTIVE GOLD OVER NICKEL TIN PLATED ON TAILS.
5. BRACKETS :- COPPER ALLOY, TIN PLATED.
6. OUTLINE OF CONNECTOR.
7. PACKING TAPE AND REEL, QUANTITY 1400 PER REEL.

## 5 WAY PCB BOARD LAYOUT



## PACKING DETAILS TBC

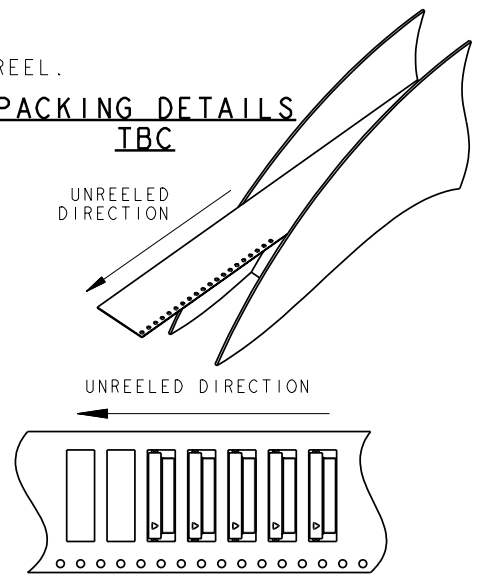

FORM-106-01-056-6 ISS 7

Release No.  
History  
101559

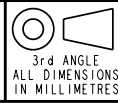

**ELCO**  
© COPYRIGHT ELCO EUROPE  
NOT TO BE DISCLOSED OR COPIED  
WITHOUT WRITTEN PERMISSION

Drawn  
N.C.H.  
  
Size  
CV

Description  
9159 TWO PART - ORDERING CODE  
  
Part Number  
00-9159-01\_100S

DATE  
06-Sept-04  
  
Issue  
C

**PLUG**  
**6 WAY 2 PART PCB STRIP CONNECTOR**

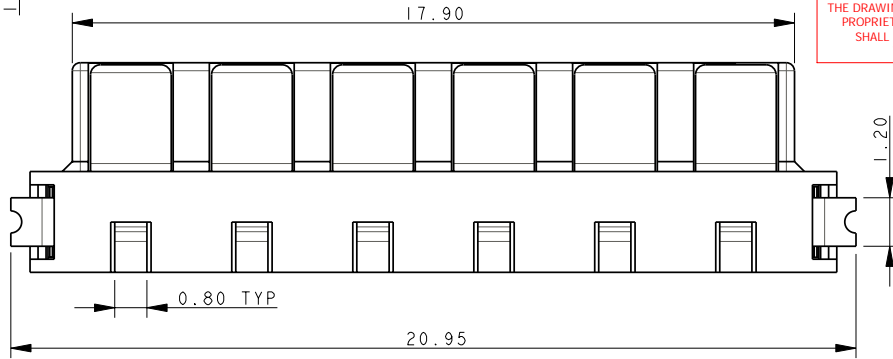
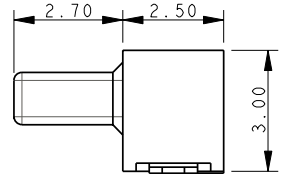
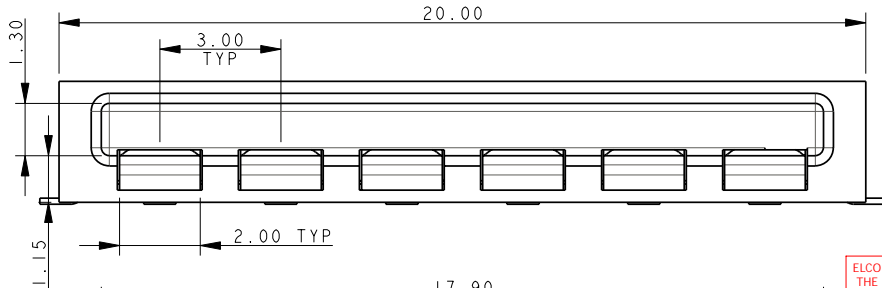
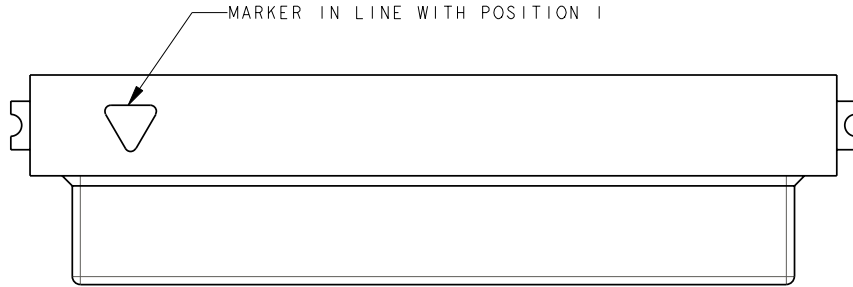

ELCO EUROPE (A DIVISION OF AVX LTD.) CONFIDENTIAL PROPRIETARY THE DRAWING ON THIS PRINT AND INFORMATION THEREWITH ARE PROPRIETARY TO ELCO EUROPE (A DIVISION OF AVX LTD.) AND SHALL NOT BE USED OR DISCUSSED IN WHOLE OR IN PART WITHOUT ELCO EUROPE'S WRITTEN CONSENT.

**NOTES:**

1. FOR MORE INFORMATION REFER TO PRODUCT SPEC 201-01-119.
2. DIMENSIONS ARE REFERENCE DIMENSIONS UNLESS TOLERANCED.
3. INSULATOR MATERIAL :- NYLON 46, COLOUR REFER TO SHEET 1.
4. CONTACT MATERIAL :- COPPER ALLOY, SELECTIVE GOLD OVER NICKEL TIN PLATED ON TAILS.
5. BRACKETS :- COPPER ALLOY, TIN PLATED.
6. OUTLINE OF CONNECTOR.
7. PACKING TAPE AND REEL, QUANTITY 1400 PER REEL.

**PACKING DETAILS**  
**TBC**

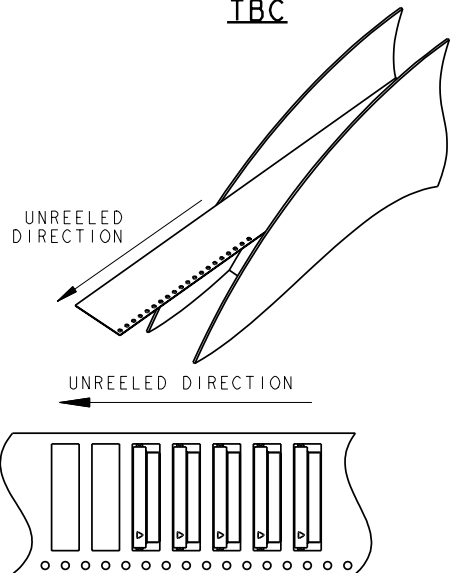

**6 WAY PCB BOARD LAYOUT**

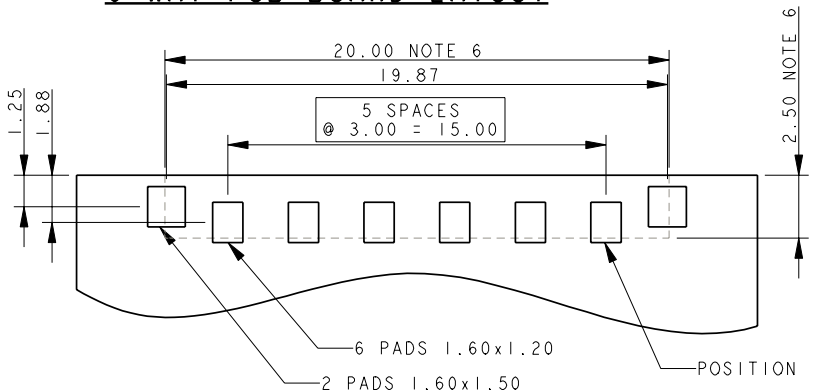

SHEET 6 OF 11

FORM-106-01-056-6 ISS 7

Release No.  
History  
102559

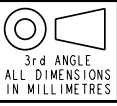

**ELCO**  
© COPYRIGHT ELCO EUROPE  
NOT TO BE DISCLOSED OR COPIED  
WITHOUT WRITTEN PERMISSION

Drawn  
N.C.H.  
Size  
CV

Description  
9159 TWO PART - ORDERING CODE  
Part Number  
00-9159-01\_100S

DATE  
06-Feb-09  
Issue  
C

# SOCKET 2 WAY 2 PART PCB STRIP CONNECTOR



MARKER IN LINE WITH POSITION I

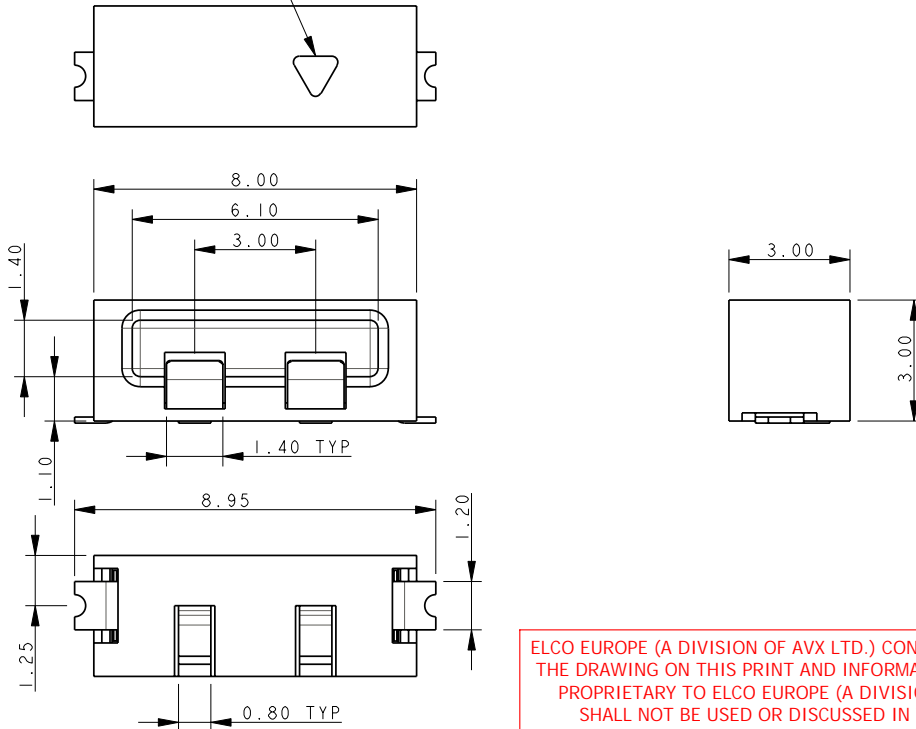

ELCO EUROPE (A DIVISION OF AVX LTD.) CONFIDENTIAL PROPRIETARY THE DRAWING ON THIS PRINT AND INFORMATION THEREWITH ARE PROPRIETARY TO ELCO EUROPE (A DIVISION OF AVX LTD.) AND SHALL NOT BE USED OR DISCUSSED IN WHOLE OR IN PART WITHOUT ELCO EUROPE'S WRITTEN CONSENT.

**NOTES:**

1. FOR MORE INFORMATION REFER TO PRODUCT SPEC 201-01-119.
2. DIMENSIONS ARE REFERENCE DIMENSIONS UNLESS TOLERANCED.
3. INSULATOR MATERIAL :- NYLON 46, COLOUR REFER TO SHEET 1.
4. CONTACT MATERIAL :- COPPER ALLOY, SELECTIVE GOLD OVER NICKEL TIN PLATED ON TAILS.
5. BRACKETS :- COPPER ALLOY, TIN PLATED.
6. OUTLINE OF CONNECTOR.
7. PACKING TAPE AND REEL, QUANTITY 1400 PER REEL.

## PACKING DETAILS IBC

## 2 WAY PCB BOARD LAYOUT

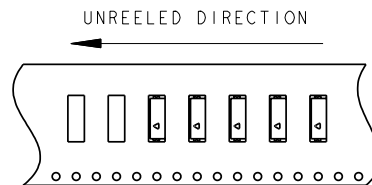
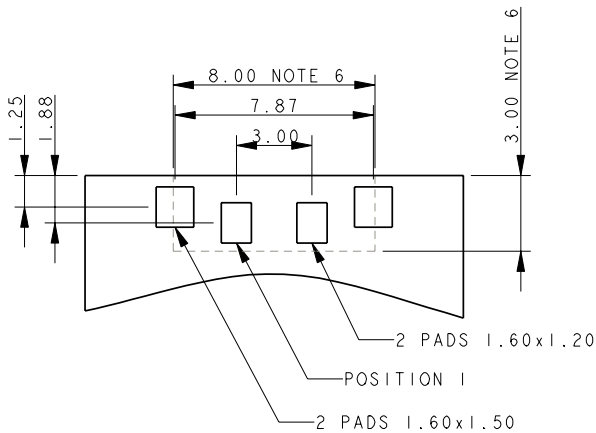

SHEET 7 OF 11

FORM-106-01-056-6 ISS 7

Release No.  
History  
102559



Drawn  
N.C.H.  
  
Size  
CV

Description 9159 TWO PART - ORDERING CODE	DATE 09-Sep-08
Part Number 00-9159-01_100S	Issue C

A

I

B

# SOCKET 3 WAY 2 PART PCB STRIP CONNECTOR



MARKER IN LINE WITH POSITION 1



ELCO EUROPE (A DIVISION OF AVX LTD.) CONFIDENTIAL PROPRIETARY THE DRAWING ON THIS PRINT AND INFORMATION THEREWITH ARE PROPRIETARY TO ELCO EUROPE (A DIVISION OF AVX LTD.) AND SHALL NOT BE USED OR DISCUSSED IN WHOLE OR IN PART WITHOUT ELCO EUROPE'S WRITTEN CONSENT.

**NOTES:**

1. FOR MORE INFORMATION REFER TO PRODUCT SPEC 201-01-119.
2. DIMENSIONS ARE REFERENCE DIMENSIONS UNLESS TOLERANCED.
3. INSULATOR MATERIAL :- NYLON 46, COLOUR REFER TO SHEET 1.
4. CONTACT MATERIAL :- COPPER ALLOY, SELECTIVE GOLD OVER NICKEL TIN PLATED ON TAILS.
5. BRACKETS :- COPPER ALLOY, TIN PLATED.
6. OUTLINE OF CONNECTOR.
7. PACKING TAPE AND REEL, QUANTITY 1400 PER REEL.

### PACKING DETAILS IBC

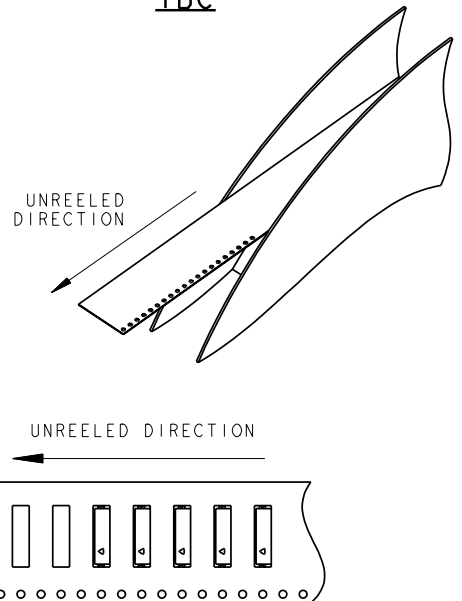

### 3 WAY PCB BOARD LAYOUT

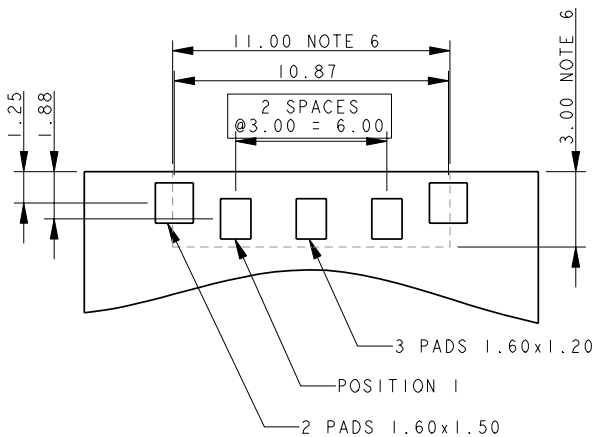

FORM-106-01-056-6 ISS 7

Release No.  
History  
102559

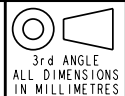

**ELCO**  
© COPYRIGHT ELCO EUROPE  
NOT TO BE DISCLOSED OR COPIED  
WITHOUT WRITTEN PERMISSION

Drawn  
N.C.H.  
Size  
CV

Description  
9159 TWO PART - ORDERING CODE  
Part Number  
00-9159-01\_100S

DATE  
09-Sep-08  
Issue  
C



# SOCKET 4 WAY 2 PART PCB STRIP CONNECTOR



ELCO EUROPE (A DIVISION OF AVX LTD.) CONFIDENTIAL PROPRIETARY THE DRAWING ON THIS PRINT AND INFORMATION THEREWITH ARE PROPRIETARY TO ELCO EUROPE (A DIVISION OF AVX LTD.) AND SHALL NOT BE USED OR DISCUSSED IN WHOLE OR IN PART WITHOUT ELCO EUROPE'S WRITTEN CONSENT.

- NOTES:
1. FOR MORE INFORMATION REFER TO PRODUCT SPEC 201-01-119.
  2. DIMENSIONS ARE REFERENCE DIMENSIONS UNLESS TOLERANCED.
  3. INSULATOR MATERIAL :- NYLON 46, COLOUR REFER TO SHEET 1.
  4. CONTACT MATERIAL :- COPPER ALLOY, SELECTIVE GOLD OVER NICKEL TIN PLATED ON TAILS.
  5. BRACKETS :- COPPER ALLOY, TIN PLATED.
  6. OUTLINE OF CONNECTOR.
  7. PACKING TAPE AND REEL, QUANTITY 1400 PER REEL.

## PACKING DETAILS TBC

## 4 WAY PCB BOARD LAYOUT



FORM-106-01-056-6 ISS 7

Release No.  
History  
102559



ELCO

© COPYRIGHT ELCO EUROPE  
NOT TO BE DISCLOSED OR COPIED  
WITHOUT WRITTEN PERMISSION

Drawn  
N.C.H.  
  
Size  
CV

Description  
9159 TWO PART - ORDERING CODE

Part Number  
00-9159-01\_100S

DATE  
09-Sep-08  
  
Issue  
C

# SOCKET 5 WAY 2 PART PCB STRIP CONNECTOR

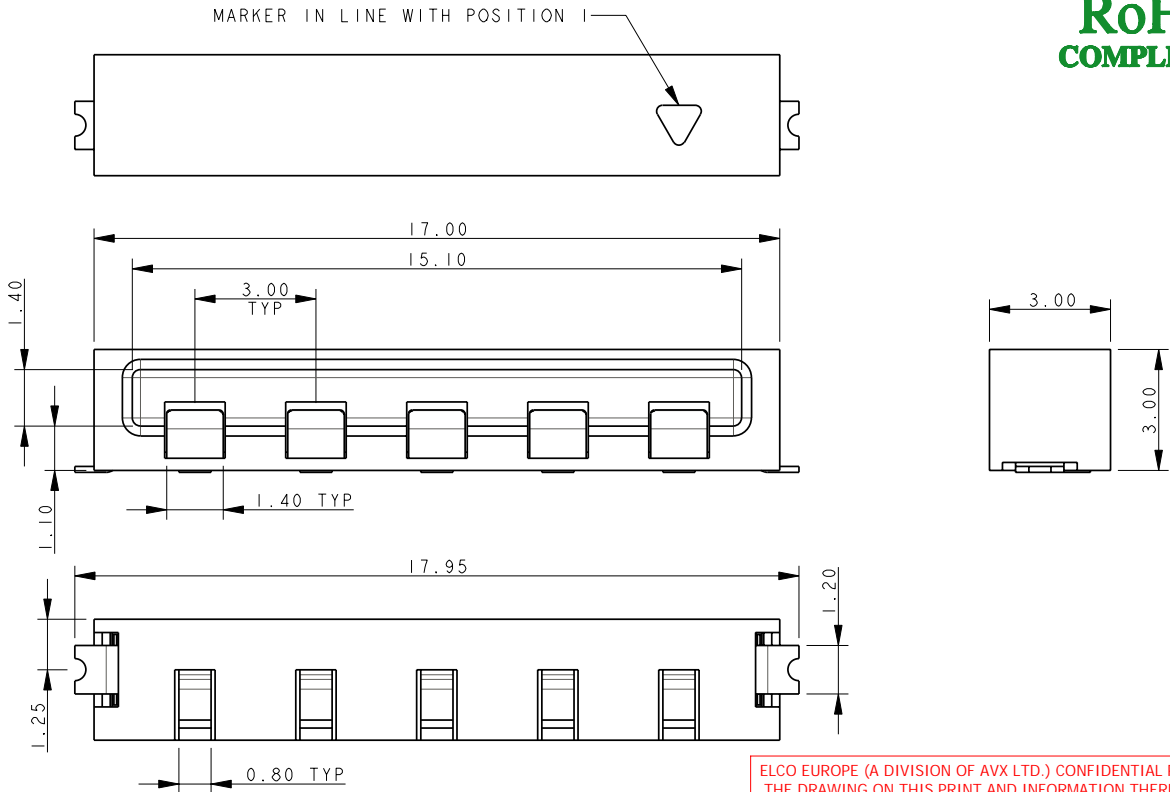

ELCO EUROPE (A DIVISION OF AVX LTD.) CONFIDENTIAL PROPRIETARY THE DRAWING ON THIS PRINT AND INFORMATION THEREWITH ARE PROPRIETARY TO ELCO EUROPE (A DIVISION OF AVX LTD.) AND SHALL NOT BE USED OR DISCUSSED IN WHOLE OR IN PART WITHOUT ELCO EUROPE'S WRITTEN CONSENT.

**NOTES:**

1. FOR MORE INFORMATION REFER TO PRODUCT SPEC 201-01-119.
2. DIMENSIONS ARE REFERENCE DIMENSIONS UNLESS TOLERANCED.
3. INSULATOR MATERIAL :- NYLON 46, COLOUR REFER TO SHEET 1.
4. CONTACT MATERIAL :- COPPER ALLOY, SELECTIVE GOLD OVER NICKEL TIN PLATED ON TAILS.
5. BRACKETS :- COPPER ALLOY, TIN PLATED.
6. OUTLINE OF CONNECTOR.
7. PACKING TAPE AND REEL, QUANTITY 1400 PER REEL.

## 5 WAY PCB BOARD LAYOUT

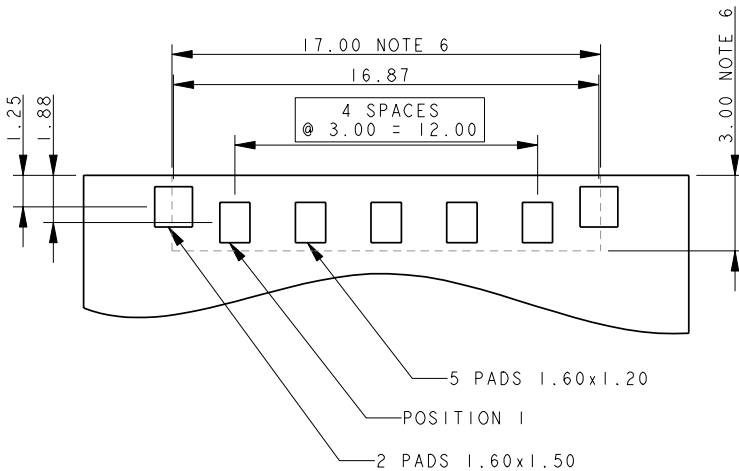

## PACKING DETAILS TBC

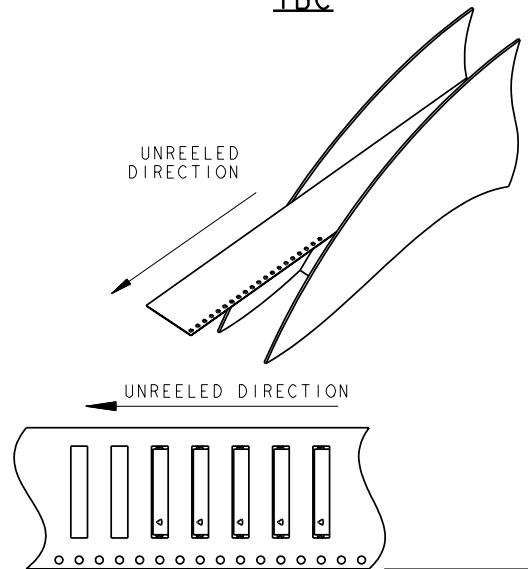

SHEET 10 OF 11

FORM-106-01-056-6 ISS 7

Release No.  
History  
102559

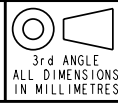

**ELCO**  
© COPYRIGHT ELCO EUROPE  
NOT TO BE DISCLOSED OR COPIED  
WITHOUT WRITTEN PERMISSION

Drawn  
N.C.H.  
Size  
CV

Description  
9159 TWO PART - ORDERING CODE  
Part Number  
00-9159-01\_100S

DATE  
09-Sep-08  
Issue  
C

# SOCKET 6 WAY 2 PART PCB STRIP CONNECTOR

ELCO EUROPE (A DIVISION OF AVX LTD.) CONFIDENTIAL PROPRIETARY THE DRAWING ON THIS PRINT AND INFORMATION THEREWITH ARE PROPRIETARY TO ELCO EUROPE (A DIVISION OF AVX LTD.) AND SHALL NOT BE USED OR DISCUSSED IN WHOLE OR IN PART WITHOUT ELCO EUROPE'S WRITTEN CONSENT.

MARKER IN LINE WITH POSITION I



**NOTES:**

1. FOR MORE INFORMATION REFER TO PRODUCT SPEC 201-01-119.
2. DIMENSIONS ARE REFERENCE DIMENSIONS UNLESS TOLERANCED.
3. INSULATOR MATERIAL :- NYLON 46, COLOUR REFER TO SHEET 1.
4. CONTACT MATERIAL :- COPPER ALLOY, SELECTIVE GOLD OVER NICKEL TIN PLATED ON TAILS.
5. BRACKETS :- COPPER ALLOY, TIN PLATED.
6. OUTLINE OF CONNECTOR.
7. PACKING TAPE AND REEL, QUANTITY 1400 PER REEL.

PACKING DETAILS  
TBC



6 WAY PCB BOARD LAYOUT

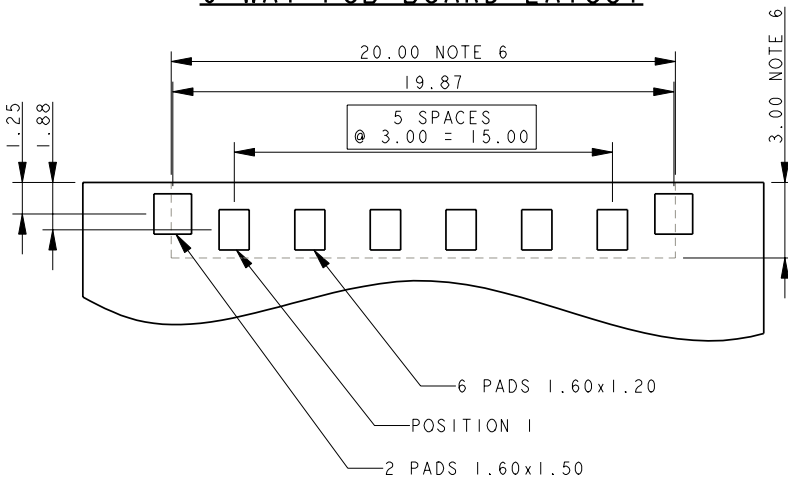

SHEET 11 OF 11

FORM-106-01-056-6 ISS 7

Release No.  
History  
102559

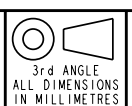

ELCO

© COPYRIGHT ELCO EUROPE  
NOT TO BE DISCLOSED OR COPIED  
WITHOUT WRITTEN PERMISSION

Drawn  
N.C.H.  
  
Size  
CV

Description  
9159 TWO PART - ORDERING CODE  
  
Part Number  
00-9159-01\_100S

DATE  
06-Feb-09  
  
Issue  
C

A

I

B



Компания «ЭлектроПласт» предлагает заключение долгосрочных отношений при поставках импортных электронных компонентов на взаимовыгодных условиях!

Наши преимущества:

- Оперативные поставки широкого спектра электронных компонентов отечественного и импортного производства напрямую от производителей и с крупнейших мировых складов;
- Поставка более 17-ти миллионов наименований электронных компонентов;
- Поставка сложных, дефицитных, либо снятых с производства позиций;
- Оперативные сроки поставки под заказ (от 5 рабочих дней);
- Экспресс доставка в любую точку России;
- Техническая поддержка проекта, помощь в подборе аналогов, поставка прототипов;
- Система менеджмента качества сертифицирована по Международному стандарту ISO 9001;
- Лицензия ФСБ на осуществление работ с использованием сведений, составляющих государственную тайну;
- Поставка специализированных компонентов (Xilinx, Altera, Analog Devices, Intersil, Interpoint, Microsemi, Aeroflex, Peregrine, Syfer, Eurofarad, Texas Instrument, Miteq, Cobham, E2V, MA-COM, Hittite, Mini-Circuits, General Dynamics и др.);

Помимо этого, одним из направлений компании «ЭлектроПласт» является направление «Источники питания». Мы предлагаем Вам помощь Конструкторского отдела:

- Подбор оптимального решения, техническое обоснование при выборе компонента;
- Подбор аналогов;
- Консультации по применению компонента;
- Поставка образцов и прототипов;
- Техническая поддержка проекта;
- Защита от снятия компонента с производства.



#### Как с нами связаться

**Телефон:** 8 (812) 309 58 32 (многоканальный)

**Факс:** 8 (812) 320-02-42

**Электронная почта:** [org@eplast1.ru](mailto:org@eplast1.ru)

**Адрес:** 198099, г. Санкт-Петербург, ул. Калинина, дом 2, корпус 4, литера А.