

## Overview

The KEMET SC-J coils are common mode chokes with a wide variety of characteristics. These toroidal coils are designed with our proprietary ferrite cores and are useful in various noise countermeasure fields.

## Applications

- Audio-visual equipment
- Home appliances
- Power supplies

## Benefits

- Proprietary 5H, 7H and 10H ferrite materials and equivalents
- Suitable for  $\geq 150$  kHz range
- Wide variety of sizes and specifications
- Operating temperature range from  $-25^{\circ}\text{C}$  to  $+105^{\circ}\text{C}$  or  $+120^{\circ}\text{C}$
- UL94 V-0 flame retardant rated base and cap



## Part Number System

| SC-    |                                    | 10-   |  | 20  | J                     |                                      |
|--------|------------------------------------|---|--|---|-----------------------|--------------------------------------|
| Series | Dimension Code<br>(See Dimensions) | Rated Current<br>(A)  | Thermal Class  | Inductance (mH)<br>Minimum  | Terminal<br>Base Type | Internal<br>Control Code             |
| SC     | Blank<br>22                        | 0x = x A<br>x0 = x0 A<br>xx = xx A<br><br>Examples:<br>02 = 2 A<br>10 = 10 A<br>15 = 15 A<br><br>Note: With exceptions,<br>see Table 1 for details. | Blank<br>E = Class E<br><br>Note: With exceptions,<br>see Table 1 for details. | x0 = x mH<br>xx = x.x mH<br>0x = 0.x mH<br>xxx = xx.x mH<br><br>Examples:<br>20 = 2 mH<br>15 = 1.5 mH<br>05 = 0.5 mH<br>115 = 11.5 mH<br><br>Note: With exceptions,<br>see Table 1 for details. | J                     | Blank<br>A<br>B<br>M<br>MI<br>N<br>P |

## Magnetic Permeability of Ferrite Material

In order to achieve most efficient noise reduction, it is important to select the material according to the target frequency band. Depending on its magnetic permeability, a particular ferrite material will be effective in a certain frequency band. A schematic representation of the relationship between the magnetic permeability of each material and the corresponding effective band range is shown in Figure 1. Materials with higher magnetic permeability are effective in the lower frequency range, while those with lower magnetic permeability are effective in the higher frequency range. Thus, Mn-Zn products are mainly used for reducing conduction noise, while Ni-Zn products are commonly used for radiation noise countermeasures.

The effective frequency range varies depending on core shape, size and number of windings. This frequency dependence of the magnetic permeability as shown in the figure serves for reference purposes only and it should be tested on the actual device to determine its effectiveness.

S18H, S15H, 10H, 7H, 5H, 1400L and 700L are KEMET's proprietary ferrite material names. Other materials can also be available on request.

Figure 1 - Relationship between the magnetic permeability of each material and its effective frequency range



## Dimensions – Millimeters

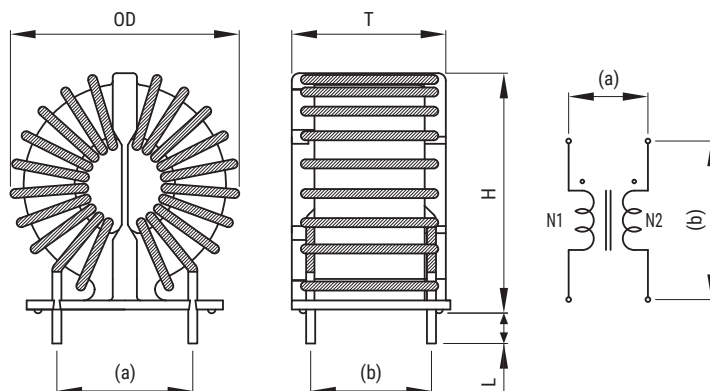

| Part Name     | Dimensions (mm) |             |             |           | Pin Pitch <sup>1</sup> (Reference) |      |
|---------------|-----------------|-------------|-------------|-----------|------------------------------------|------|
|               | OD (Maximum)    | T (Maximum) | H (Maximum) | L         | a                                  | b    |
| SC-02-10J     | 25.0            | 20.0        | 27.0        | 5.00±2.0  | 10                                 | 15   |
| SC-02-20J     | 25.0            | 20.0        | 27.0        | 5.00±2.0  | 10                                 | 15   |
| SC-02-30J     | 25.0            | 20.0        | 27.0        | 5.00±2.0  | 10                                 | 15   |
| SC-02-50J     | 25.0            | 20.0        | 27.0        | 5.00±2.0  | 10                                 | 15   |
| SC-02-70J     | 25.0            | 20.0        | 27.0        | 5.00±2.0  | 10                                 | 15   |
| SC-02-100J    | 25.0            | 20.0        | 27.0        | 5.00±2.0  | 10                                 | 15   |
| SC-02-E115J   | 25.0            | 15.4        | 27.5        | 3.50±1.0  | 13                                 | 11   |
| SC-02-E120J   | 24.0            | 16.0        | 25.0        | 3.50±1.5  | 13                                 | 11   |
| SC-02-300J    | 33.0            | 23.0        | 33.0        | 7.00±2.0  | 18                                 | 16   |
| SC22-025-290J | 30.0            | 20.0        | 29.0        | 5.00±2.0  | 10                                 | 15   |
| SC-03-28J     | 25.0            | 20.0        | 27.0        | 5.00±2.0  | 10                                 | 15   |
| SC-03-30J     | 25.0            | 20.0        | 27.0        | 5.00±2.0  | 10                                 | 15   |
| SC-03-55J     | 25.0            | 20.0        | 27.0        | 5.00±2.0  | 10                                 | 15   |
| SC-03-67J     | 24.0            | 20.0        | 26.0        | 5.00±1.0  | 10                                 | 15   |
| SC-03-85J     | 25.0            | 20.0        | 27.0        | 5.00±2.0  | 10                                 | 15   |
| SC-04-20JN    | 25.0            | 20.0        | 27.0        | 5.00±2.0  | 10                                 | 15   |
| SC-05-50J     | 34.0            | 23.0        | 33.0        | 5.00±2.0  | 18                                 | 16   |
| SC-05-80J     | 34.0            | 23.0        | 33.0        | 5.00±2.0  | 18                                 | 16   |
| SC22-04-100J  | 30.0            | 22.0        | 32.0        | 3.50±1.0  | 18                                 | 16   |
| SC-04-200J    | 34.0            | 23.0        | 33.0        | 5.00±2.0  | 18                                 | 16   |
| SC-04-E17J    | 23.5            | 19.4        | 24.0        | 3.30±1.0  | 20                                 | 16.5 |
| SC-04-E50J    | 23.5            | 19.4        | 24.0        | 3.30±1.0  | 20                                 | 16.5 |
| SC-05-06J     | 25.0            | 20.0        | 27.0        | 10.00±2.0 | 10                                 | 15   |
| SC-05-10J     | 25.0            | 20.0        | 27.0        | 5.00±2.0  | 10                                 | 15   |
| SC-05-15J     | 25.0            | 20.0        | 27.0        | 3.40±1.0  | 22                                 | 19   |
| SC-05-21J     | 34.0            | 23.0        | 33.0        | 5.00±2.0  | 18                                 | 16   |
| SC-05-20J     | 34.0            | 23.0        | 33.0        | 5.00±2.0  | 18                                 | 16   |
| SC-05-27J     | 25.0            | 20.0        | 27.0        | 5.00±2.0  | 10                                 | 15   |
| SC-05-30J     | 34.0            | 23.0        | 33.0        | 5.00±2.0  | 18                                 | 16   |
| SC22-05-30J   | 28.0            | 18.5        | 29.0        | 5.00±2.0  | 10                                 | 15   |
| SC22-05-70J   | 28.0            | 18.5        | 29.0        | 5.00±2.0  | 10                                 | 15   |
| SC-05-100J    | 34.0            | 23.0        | 33.0        | 5.00±2.0  | 18                                 | 16   |
| SC-06-10J-B   | 25.0            | 20.0        | 27.0        | 4.50±1.0  | 10                                 | 15   |
| SC-06-35J     | 34.0            | 24.0        | 33.0        | 3.50±1.0  | 12                                 | 17   |
| SC-06-40J     | 35.0            | 25.0        | 33.0        | 5.00±1.0  | 18                                 | 16   |
| SC-06-60J     | 34.0            | 25.0        | 33.0        | 5.00±2.0  | 18                                 | 16   |
| SC22-06-60J   | 29.5            | 20.5        | 29.5        | 5.00±2.0  | 10                                 | 15   |
| SC-07-10J     | 34.0            | 23.0        | 33.0        | 5.00±1.5  | 18                                 | 16   |
| SC-07-30JM    | 33.0            | 23.0        | 33.0        | 3.75±1.0  | 18                                 | 16   |
| SC-07-42J     | 34.0            | 24.0        | 33.0        | 4.50±1.0  | 18                                 | 16   |

<sup>1</sup> Pin pitch listed above for reference only. Values not guaranteed.

## Dimensions – Millimeters cont.



| Part Name    | Dimensions (mm) |             |             |          | Pin Pitch <sup>1</sup> (Reference) |    |
|--------------|-----------------|-------------|-------------|----------|------------------------------------|----|
|              | OD (Maximum)    | T (Maximum) | H (Maximum) | L        | a                                  | b  |
| SC-07-70J    | 35.0            | 25.0        | 35.0        | 5.00±2.0 | 18                                 | 16 |
| SC-07-90J    | 34.0            | 23.0        | 33.0        | 5.00±2.0 | 18                                 | 16 |
| SC-07-50J    | 34.0            | 24.0        | 33.0        | 4.10±1.5 | 18                                 | 16 |
| SC-08-E075J  | 25.0            | 16.0        | 25.5        | 3.50±1.0 | 19.5                               | 11 |
| SC-08-20J    | 34.0            | 23.0        | 33.0        | 7.00±2.0 | 12                                 | 17 |
| SC-08-30J    | 34.0            | 23.0        | 33.0        | 5.00±2.0 | 18                                 | 16 |
| SC-08-44J    | 35.0            | 23.0        | 33.0        | 5.00±2.0 | 18                                 | 16 |
| SC-08-100JM  | 41.0            | 32.0        | 40.0        | 3.50±1.0 | 18                                 | 16 |
| SC-10-E035J  | 25.0            | 16.0        | 24.0        | 4.00±1.5 | 19.5                               | 11 |
| SC-10-10J    | 34.0            | 23.0        | 33.0        | 5.00±2.0 | 12                                 | 17 |
| SC-10-14J    | 34.0            | 24.0        | 33.0        | 5.00±2.0 | 12                                 | 17 |
| SC-10-15J-MI | 34.0            | 23.0        | 34.0        | 3.75±1.0 | 12                                 | 17 |
| SC-10-18J    | 34.0            | 24.0        | 33.0        | 7.00±2.0 | 18                                 | 16 |
| SC-10-20J    | 42.0            | 29.0        | 44.0        | 5.00±2.0 | 18                                 | 22 |
| SC-10-30J    | 34.0            | 24.0        | 33.0        | 5.00±2.0 | 18                                 | 16 |
| SC-10-E55J   | 44.0            | 30.0        | 44.0        | 5.00±2.0 | 18                                 | 22 |
| SC-11-16J    | 35.0            | 23.0        | 33.0        | 5.00±2.0 | 18                                 | 16 |
| SC-11-20J    | 35.0            | 23.0        | 33.0        | 5.00±2.0 | 18                                 | 16 |
| SC-12-E035J  | 25.0            | 16.0        | 25.5        | 4.00±1.5 | 19.5                               | 11 |
| SC-12-15J    | 42.0            | 29.0        | 44.0        | 5.00±2.0 | 18                                 | 22 |
| SC-14-12J    | 34.0            | 24.0        | 33.0        | 5.00±2.0 | 18                                 | 16 |
| SC-15-02J    | 34.0            | 23.0        | 33.0        | 5.00±2.0 | 18                                 | 16 |
| SC-15-05J    | 34.0            | 23.0        | 33.0        | 5.00±2.0 | 18                                 | 16 |
| SC-15-07J    | 36.0            | 25.0        | 35.0        | 5.00±2.0 | 18                                 | 16 |
| SC-15-09J    | 36.0            | 25.0        | 35.0        | 5.00±2.0 | 18                                 | 16 |
| SC-15-10J    | 44.0            | 30.0        | 44.0        | 5.00±2.0 | 18                                 | 22 |
| SC-15-12J-MI | 35.0            | 25.0        | 35.0        | 3.75±1.0 | 18                                 | 16 |
| SC-15-E37J   | 44.0            | 30.0        | 44.0        | 5.00±2.0 | 18                                 | 22 |
| SC-18-05J    | 44.0            | 30.0        | 44.0        | 5.00±2.0 | 18                                 | 22 |
| SC-18-10J    | 35.0            | 24.0        | 33.0        | 5.00±2.0 | 18                                 | 16 |
| SC-18-085J   | 36.0            | 25.0        | 35.0        | 5.00±2.0 | 18                                 | 16 |
| SC-18-095J   | 36.0            | 25.0        | 35.0        | 5.00±2.0 | 18                                 | 16 |
| SC-18-E12J   | 50.0            | 31.0        | 50.0        | 4.10±1.0 | 40                                 | 25 |
| SC-18-E15J   | 44.0            | 30.0        | 44.0        | 5.00±2.0 | 18                                 | 12 |
| SC-18-25J    | 44.0            | 30.0        | 44.0        | 4.50±1.0 | 18                                 | 22 |
| SC-20-01J-A  | 35.0            | 24.0        | 34.0        | 4.50±1.0 | 18                                 | 16 |
| SC-20-03J    | 35.0            | 24.0        | 34.0        | 4.50±1.0 | 18                                 | 16 |
| SC-20-05J-P  | 36.0            | 25.0        | 35.0        | 5.00±2.0 | 18                                 | 16 |
| SC-20-E085JM | 46.0            | 32.0        | 46.0        | 5.00±2.0 | 18                                 | 22 |
| SC-20-E18J   | 50.0            | 31.0        | 53.0        | 5.00±2.0 | 40                                 | 25 |

<sup>1</sup> Pin pitch listed above for reference only. Values not guaranteed.

## Environmental Compliance

All KEMET AC line filters are RoHS Compliant.



## Performance Characteristics

| Item                             | Performance Characteristics  |
|----------------------------------|--|
| Rated Voltage                    | 250 VAC/VDC  |
| Withstanding Voltage             | 2,400 V (2 seconds, between lines)   |
| Insulation Resistance            | > 100 MΩ at 500 VDC (between lines)  |
| Rated Current Range              | 2 – 20 A   |
| Rated Inductance Range           | 0.15 – 30 mH minimum   |
| Inductance Measurement Condition | 1 kHz, 10 kHz, 16kHz, and 100 kHz  |
| Thermal Class                    | A (105°C) and E (120°C)  |
| Operating Temperature Range      | -25°C to +105°C (include self temperature rise) and<br>-25°C to +120°C (include self temperature rise) |

**Table 1 – Ratings & Part Number Reference**

| Part Number   | Rated Current (A) | Inductance (mH) Minimum | DC Resistance/Line (mΩ) Maximum | Temperature Rise (K) Maximum | Wire Diameter (mm) | Thermal Class | Weight (g) Approximate |
|---------------|-------------------|-------------------------|---------------------------------|------------------------------|--------------------|---------------|------------------------|
| SC-02-10J     | 2.0               | 1.0000 <sup>4</sup>     | 100.0                           | 40.0                         | 0.60               | E (120°C)     | 15.0                   |
| SC-02-20J     | 2.0               | 2.0000 <sup>4</sup>     | 110.0                           | 40.0                         | 0.60               | E (120°C)     | 15.0                   |
| SC-02-30J     | 2.0               | 3.0000 <sup>4</sup>     | 110.0                           | 40.0                         | 0.60               | E (120°C)     | 16.0                   |
| SC-02-50J     | 2.0               | 5.0000 <sup>4</sup>     | 120.0                           | 40.0                         | 0.60               | E (120°C)     | 20.0                   |
| SC-02-70J     | 2.0               | 7.0000 <sup>1</sup>     | 110.0                           | 40.0                         | 0.60               | E (120°C)     | 18.2                   |
| SC-02-100J    | 2.0               | 10.0000 <sup>4</sup>    | 220.0                           | 55.0                         | 0.50               | E (120°C)     | 18.0                   |
| SC-02-E115J   | 2.0               | 11.5000 <sup>2</sup>    | 155.0                           | 55.0                         | 0.50               | E (120°C)     | 13.0                   |
| SC-02-E120J   | 2.0               | 12.0000 <sup>2</sup>    | 180.0                           | 70.0                         | 0.55               | E (120°C)     | 13.0                   |
| SC-02-300J    | 2.0               | 30.0000 <sup>1</sup>    | 300.0                           | 45.0                         | 0.60               | E (120°C)     | 36.9                   |
| SC22-025-290J | 2.5               | 29.0000 <sup>2</sup>    | 250.0                           | 65.0                         | 0.60               | E (120°C)     | 31.4                   |
| Part Number   | Rated Current (A) | Inductance (mH) Minimum | DC Resistance/Line (mΩ) Maximum | Temperature Rise (K) Maximum | Wire Diameter (mm) | Thermal Class | Weight (g) Approximate |

<sup>1</sup> Inductance Measurement Condition: 1 kHz

<sup>2</sup> Inductance Measurement Condition: 10 kHz

<sup>3</sup> Inductance Measurement Condition: 16 kHz

<sup>4</sup> Inductance Measurement Condition: 100 kHz

**Table 1 – Ratings & Part Number Reference cont.**

| Part Number  | Rated Current (A) | Inductance (mH) Minimum | DC Resistance/Line (mΩ) Maximum | Temperature Rise (K) Maximum | Wire Diameter (mm) | Thermal Class | Weight (g) Approximate |
|--------------|-------------------|-------------------------|---------------------------------|------------------------------|--------------------|---------------|------------------------|
| SC-03-28J    | 3.0               | 2.8000 <sup>2</sup>     | 55.0                            | 40.0                         | 0.70               | E (120°C)     | 18.7                   |
| SC-03-30J    | 3.0               | 3.0000 <sup>4</sup>     | 110.0                           | 50.0                         | 0.65               | E (120°C)     | 19.6                   |
| SC-03-55J    | 3.0               | 5.5000 <sup>4</sup>     | 110.0                           | 60.0                         | 0.65               | E (120°C)     | 22.0                   |
| SC-03-67J    | 3.0               | 6.7000 <sup>4</sup>     | 105.0                           | 65.0                         | 0.65               | E (120°C)     | 21.0                   |
| SC-03-85J    | 3.0               | 8.5000 <sup>2</sup>     | 110.0                           | 60.0                         | 0.65               | E (120°C)     | 22.0                   |
| SC-04-20JN   | 4.0               | 2.0000 <sup>4</sup>     | 50.0                            | 50.0                         | 0.80               | E (120°C)     | 20.4                   |
| SC-05-50J    | 4.0               | 5.0000 <sup>4</sup>     | 80.0                            | 60.0                         | 0.80               | E (120°C)     | 32.0                   |
| SC-05-80J    | 4.0               | 8.0000 <sup>4</sup>     | 90.0                            | 60.0                         | 0.80               | E (120°C)     | 42.0                   |
| SC22-04-100J | 4.0               | 10.0000 <sup>2</sup>    | 71.0                            | 50.5                         | 0.80               | E (120°C)     | 30.0                   |
| SC-04-200J   | 4.0               | 20.3000 <sup>1</sup>    | 150.0                           | 55.0                         | 0.80               | E (120°C)     | 43.2                   |
| SC-04-E17J   | 4.3               | 1.7850 <sup>2</sup>     | 31.8                            | 45.0                         | 0.70               | E (120°C)     | 16.5                   |
| SC-04-E50J   | 4.3               | 5.1800 <sup>2</sup>     | 56.4                            | 70.0                         | 0.70               | E (120°C)     | 19.2                   |
| SC-05-06J    | 5.0               | 0.6000 <sup>4</sup>     | 27.0                            | 40.0                         | 0.80               | E (120°C)     | 16.7                   |
| SC-05-10J    | 5.0               | 1.0000 <sup>4</sup>     | 50.0                            | 40.0                         | 0.80               | E (120°C)     | 20.0                   |
| SC-05-15J    | 5.0               | 1.5000 <sup>4</sup>     | 40.0                            | 45.0                         | 0.80               | E (120°C)     | 18.7                   |
| SC-05-20J    | 5.0               | 2.0000 <sup>4</sup>     | 70.0                            | 40.0                         | 0.80               | E (120°C)     | 25.0                   |
| SC-05-21J    | 5.0               | 2.0000 <sup>4</sup>     | 40.0                            | 35.0                         | 1.00               | E (120°C)     | 38.6                   |
| SC-05-27J    | 5.0               | 2.7000 <sup>1</sup>     | 40.0                            | 57.0                         | 0.80               | E (120°C)     | 19.4                   |
| SC-05-30J    | 5.0               | 3.0000 <sup>4</sup>     | 70.0                            | 55.0                         | 0.80               | E (120°C)     | 30.0                   |
| SC22-05-30J  | 5.0               | 3.0000 <sup>2</sup>     | 50.0                            | 50.0                         | 0.80               | E (120°C)     | 30.6                   |
| SC22-05-70J  | 5.0               | 7.0000 <sup>2</sup>     | 60.0                            | 75.0                         | 0.80               | E (120°C)     | 31.9                   |
| SC-05-100J   | 5.0               | 10.5000 <sup>3</sup>    | 100.0                           | 55.0                         | 0.90               | E (120°C)     | 40.8                   |
| SC-06-10J-B  | 6.0               | 1.0000 <sup>1</sup>     | 30.0                            | 45.0                         | 0.85               | E (120°C)     | 18.9                   |
| SC-06-35J    | 6.0               | 3.5000 <sup>2</sup>     | 50.0                            | 51.0                         | 1.00               | E (120°C)     | 40.0                   |
| SC-06-40J    | 6.0               | 4.0000 <sup>1</sup>     | 40.0                            | 50.0                         | 1.10               | E (120°C)     | 47.9                   |
| SC-06-60J    | 6.0               | 6.0000 <sup>2</sup>     | 60.0                            | 70.0                         | 1.00               | E (120°C)     | 44.1                   |
| SC22-06-60J  | 6.0               | 6.0000 <sup>2</sup>     | 46.0                            | 83.0                         | 0.90               | E (120°C)     | 29.0                   |
| SC-07-10J    | 7.0               | 1.0000 <sup>4</sup>     | 24.0                            | 45.0                         | 1.00               | E (120°C)     | 34.3                   |
| SC-07-30JM   | 7.0               | 3.0000 <sup>2</sup>     | 39.0                            | 50.0                         | 1.00               | E (120°C)     | 43.0                   |
| SC-07-42J    | 7.0               | 4.2000 <sup>4</sup>     | 42.0                            | 65.0                         | 1.10               | E (120°C)     | 45.2                   |
| SC-07-70J    | 7.0               | 7.0000 <sup>1</sup>     | 40.0                            | 65.0                         | 1.10               | E (120°C)     | 45.0                   |
| SC-07-90J    | 7.0               | 9.0000 <sup>2</sup>     | 50.0                            | 85.0                         | 1.00               | E (120°C)     | 45.8                   |
| SC-07-50J    | 7.3               | 5.0000 <sup>2</sup>     | 27.0                            | 55.0                         | 1.20               | E (120°C)     | 53.0                   |
| SC-08-E075J  | 8.0               | 0.7500 <sup>2</sup>     | 12.7                            | 55.0                         | 0.90               | E (120°C)     | 16.4                   |
| SC-08-20J    | 8.0               | 2.0000 <sup>4</sup>     | 50.0                            | 45.0                         | 1.20               | E (120°C)     | 45.6                   |
| Part Number  | Rated Current (A) | Inductance (mH) Minimum | DC Resistance/Line (mΩ) Maximum | Temperature Rise (K) Maximum | Wire Diameter (mm) | Thermal Class | Weight (g) Approximate |

<sup>1</sup> Inductance Measurement Condition: 1 kHz

<sup>2</sup> Inductance Measurement Condition: 10 kHz

<sup>3</sup> Inductance Measurement Condition: 16 kHz

<sup>4</sup> Inductance Measurement Condition: 100 kHz

**Table 1 – Ratings & Part Number Reference cont.**

| Part Number  | Rated Current (A) | Inductance (mH) Minimum | DC Resistance/Line (mΩ) Maximum | Temperature Rise (K) Maximum | Wire Diameter (mm) | Thermal Class | Weight (g) Approximate |
|--------------|-------------------|-------------------------|---------------------------------|------------------------------|--------------------|---------------|------------------------|
| SC-08-30J    | 8.0               | 3.0000 <sup>4</sup>     | 54.0                            | 55.0                         | 1.00               | E (120°C)     | 40.9                   |
| SC-08-44J    | 8.0               | 4.4000 <sup>4</sup>     | 25.0                            | 50.0                         | 1.20               | E (120°C)     | 46.1                   |
| SC-08-100JM  | 8.0               | 13.0000 <sup>4</sup>    | 50.0                            | 70.0                         | 1.30               | E (120°C)     | 93.0                   |
| SC-10-E035J  | 10.0              | 0.3500 <sup>2</sup>     | 8.0                             | 46.0                         | 1.00               | E (120°C)     | 11.0                   |
| SC-10-10J    | 10.0              | 1.0000 <sup>4</sup>     | 20.0                            | 40.0                         | 1.30               | A (105°C)     | 42.0                   |
| SC-10-14J    | 10.0              | 1.4000 <sup>4</sup>     | 18.0                            | 65.0                         | 1.30               | E (120°C)     | 43.9                   |
| SC-10-15J-MI | 10.0              | 1.5000 <sup>4</sup>     | 15.7                            | 65.0                         | 1.30               | E (120°C)     | 45.0                   |
| SC-10-18J    | 10.0              | 1.6000 <sup>1</sup>     | 20.0                            | 55.0                         | 1.30               | E (120°C)     | 45.2                   |
| SC-10-20J    | 10.0              | 2.0000 <sup>4</sup>     | 22.0                            | 50.0                         | 1.40               | A (105°C)     | 70.0                   |
| SC-10-30J    | 10.0              | 3.0000 <sup>4</sup>     | 30.0                            | 75.0                         | 1.20               | E (120°C)     | 65.0                   |
| SC-10-E55J   | 10.0              | 5.5000 <sup>2</sup>     | 24.0                            | 70.0                         | 1.40               | E (120°C)     | 82.0                   |
| SC-11-16J    | 11.0              | 1.6000 <sup>2</sup>     | 13.0                            | 45.0                         | 1.20               | E (120°C)     | 35.0                   |
| SC-11-20J    | 11.0              | 2.0000 <sup>2</sup>     | 14.0                            | 50.0                         | 1.40               | E (120°C)     | 44.1                   |
| SC-12-E035J  | 12.0              | 0.3500 <sup>2</sup>     | 8.0                             | 60.0                         | 1.10               | E (120°C)     | 11.0                   |
| SC-12-15J    | 12.0              | 1.5000 <sup>4</sup>     | 18.0                            | 50.0                         | 1.50               | A (105°C)     | 70.0                   |
| SC-14-12J    | 14.0              | 1.2000 <sup>2</sup>     | 12.2                            | 55.0                         | 1.50               | E (120°C)     | 45.0                   |
| SC-15-02J    | 15.0              | 0.2000 <sup>4</sup>     | 6.0                             | 45.0                         | 1.60               | E (120°C)     | 43.0                   |
| SC-15-05J    | 15.0              | 0.5000 <sup>4</sup>     | 8.0                             | 60.0                         | 1.50               | E (120°C)     | 40.0                   |
| SC-15-07J    | 15.0              | 0.7020 <sup>4</sup>     | 10.0                            | 60.0                         | 1.60               | E (120°C)     | 46.4                   |
| SC-15-09J    | 15.0              | 0.9000 <sup>4</sup>     | 20.0                            | 65.0                         | 1.50               | E (120°C)     | 45.5                   |
| SC-15-10J    | 15.0              | 1.0000 <sup>4</sup>     | 12.0                            | 55.0                         | 1.70               | A (105°C)     | 75.0                   |
| SC-15-12J-MI | 15.0              | 1.2000 <sup>2</sup>     | 6.2                             | 60.0                         | 1.60               | E (120°C)     | 45.2                   |
| SC-15-E37J   | 15.0              | 3.7000 <sup>2</sup>     | 16.0                            | 92.0                         | 1.50               | E (120°C)     | 82.4                   |
| SC-18-05J    | 18.0              | 0.5000 <sup>4</sup>     | 7.0                             | 50.0                         | 1.80               | A (105°C)     | 60.0                   |
| SC-18-085J   | 18.0              | 0.8500 <sup>2</sup>     | 6.0                             | 75.0                         | 1.60               | E (120°C)     | 45.0                   |
| SC-18-095J   | 18.0              | 0.9500 <sup>2</sup>     | 5.5                             | 56.0                         | 1.70               | E (120°C)     | 45.0                   |
| SC-18-E12J   | 18.0              | 1.2000 <sup>2</sup>     | 9.0                             | 65.0                         | 1.70               | E (120°C)     | 110.0                  |
| SC-18-E15J   | 18.0              | 1.5000 <sup>2</sup>     | 8.0                             | 60.0                         | 1.70               | E (120°C)     | 80.0                   |
| SC-18-25J    | 18.0              | 2.5000 <sup>2</sup>     | 10.0                            | 60.0                         | 1.70               | E (120°C)     | 77.0                   |
| SC-20-01J-A  | 20.0              | 0.1500 <sup>1</sup>     | 4.0                             | 50.0                         | 1.80               | E (120°C)     | 39.6                   |
| SC-20-03J    | 20.0              | 0.3000 <sup>1</sup>     | 4.0                             | 50.0                         | 1.80               | E (120°C)     | 39.4                   |
| SC-20-05J-P  | 20.0              | 0.4875 <sup>4</sup>     | 3.6                             | 60.0                         | 1.80               | E (120°C)     | 44.2                   |
| SC-18-10J    | 20.0              | 0.7000 <sup>4</sup>     | 20.0                            | 72.0                         | 1.70               | E (120°C)     | 45.4                   |
| SC-20-E085JM | 20.0              | 1.2000 <sup>2</sup>     | 6.0                             | 46.0                         | 2.10               | E (120°C)     | 90.0                   |
| SC-20-E18J   | 20.0              | 1.8000 <sup>2</sup>     | 6.8                             | 65.0                         | 2.00               | E (120°C)     | 115.0                  |
| Part Number  | Rated Current (A) | Inductance (mH) Minimum | DC Resistance/Line (mΩ) Maximum | Temperature Rise (K) Maximum | Wire Diameter (mm) | Thermal Class | Weight (g) Approximate |

<sup>1</sup> Inductance Measurement Condition: 1 kHz

<sup>2</sup> Inductance Measurement Condition: 10 kHz

<sup>3</sup> Inductance Measurement Condition: 16 kHz

<sup>4</sup> Inductance Measurement Condition: 100 kHz

## Frequency Characteristics

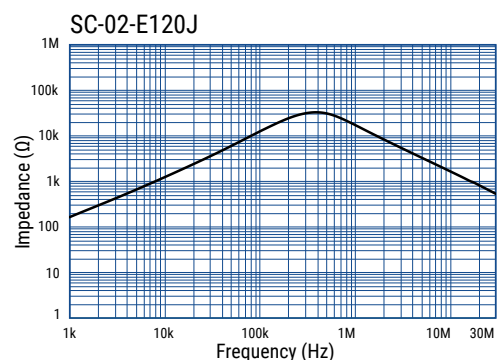
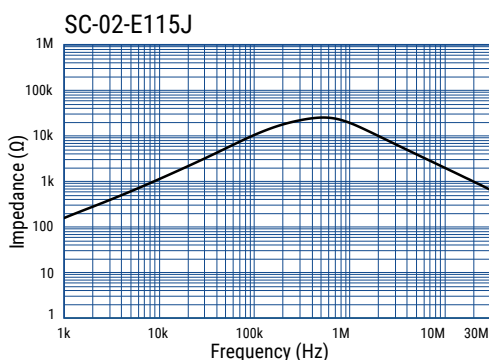
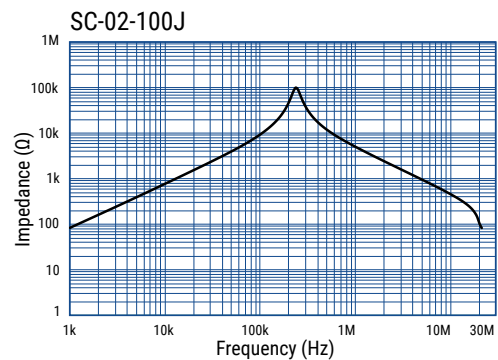
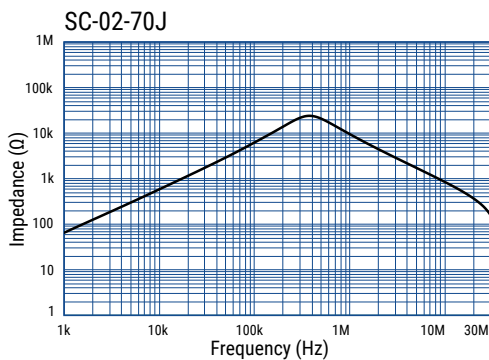



## Frequency Characteristics cont.

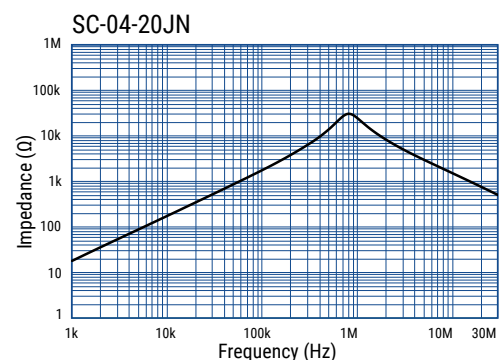
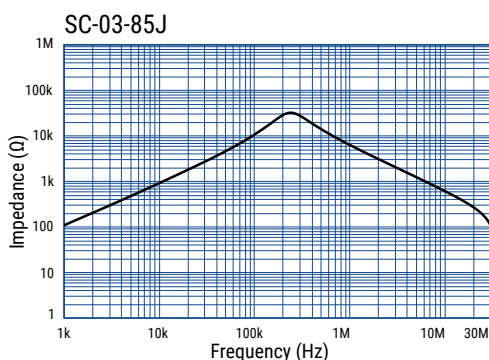

## Frequency Characteristics cont.



## Frequency Characteristics cont.

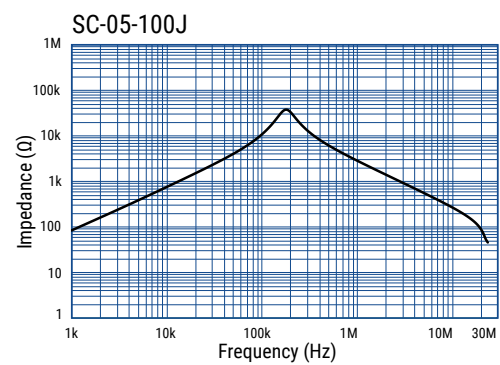
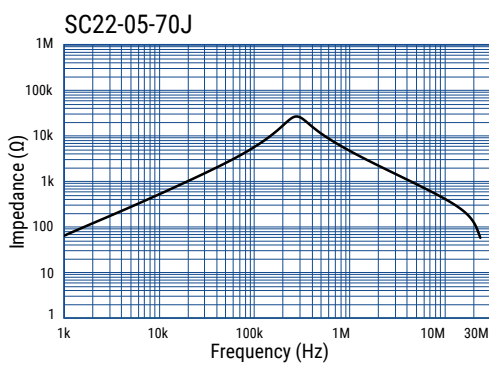
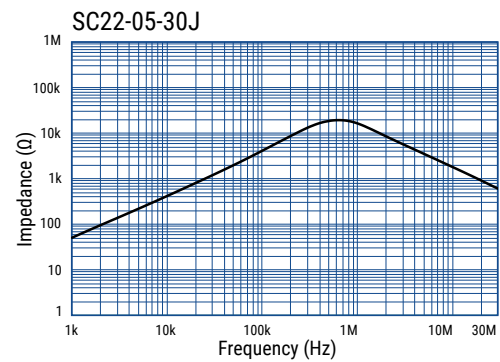
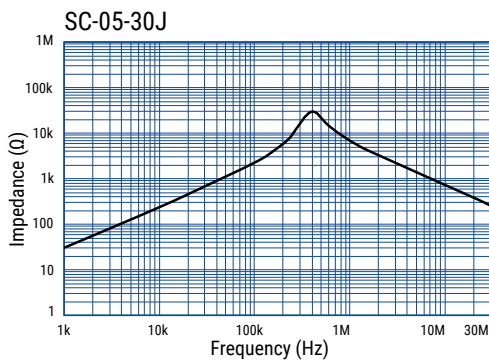
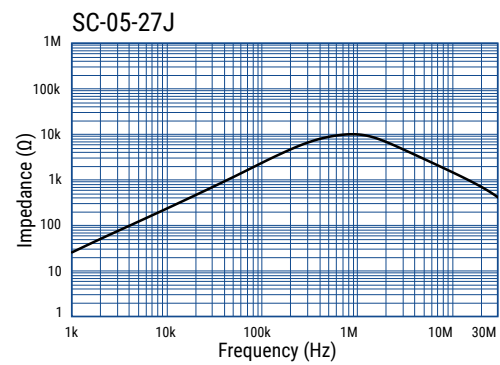
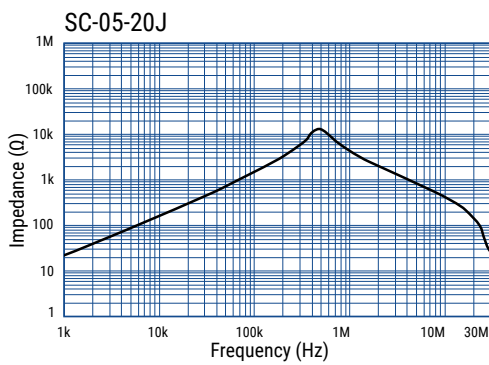

## Frequency Characteristics cont.



## Frequency Characteristics cont.

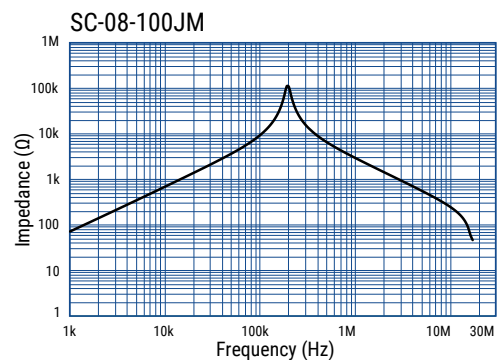
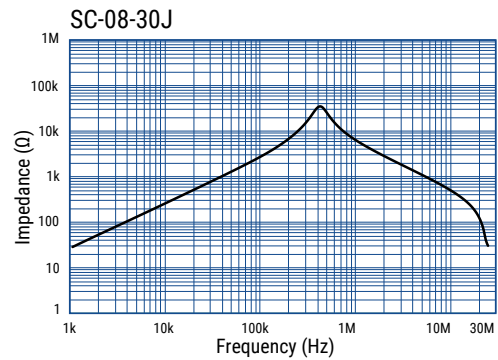
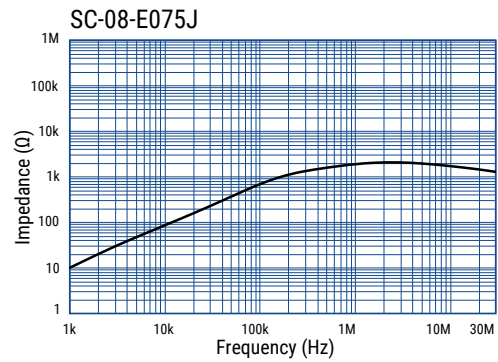
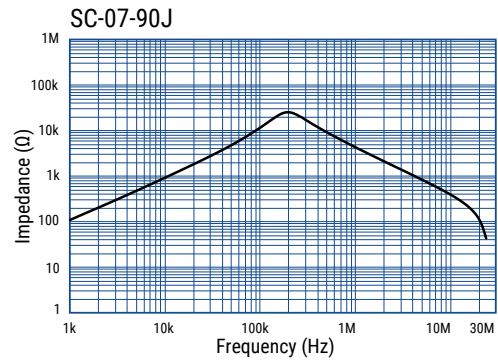

## Frequency Characteristics cont.

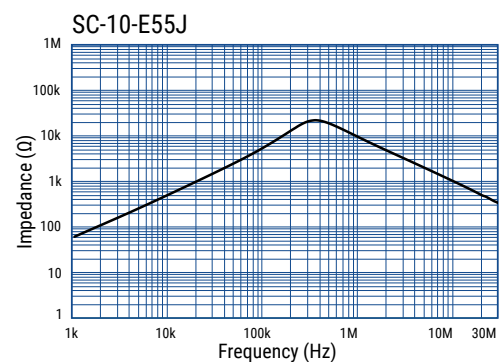
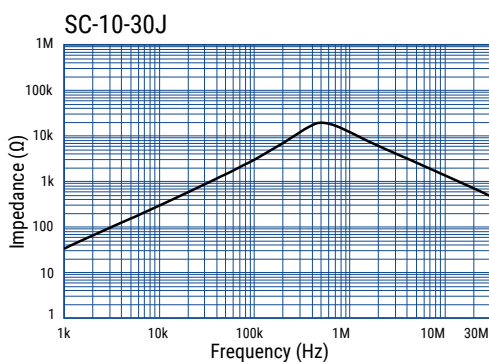
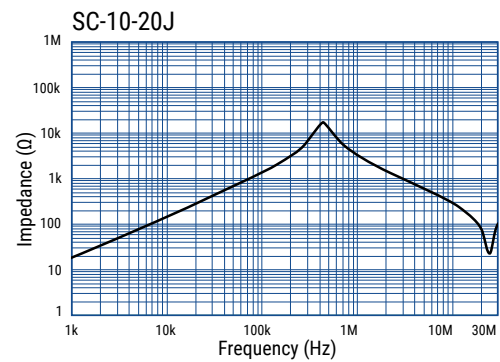
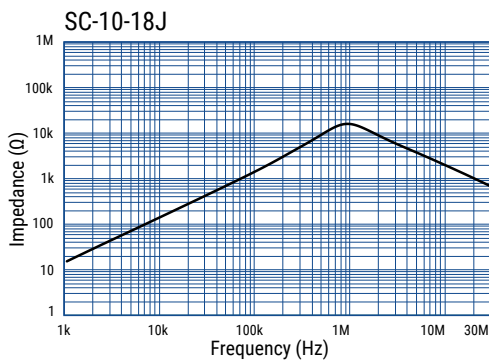

## Frequency Characteristics cont.

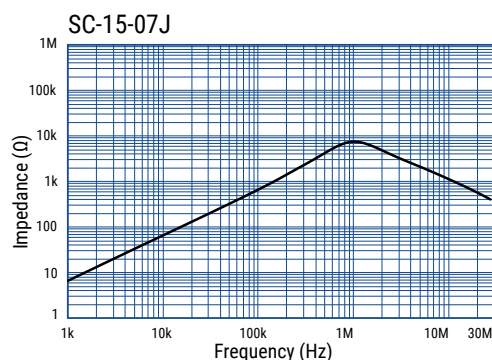
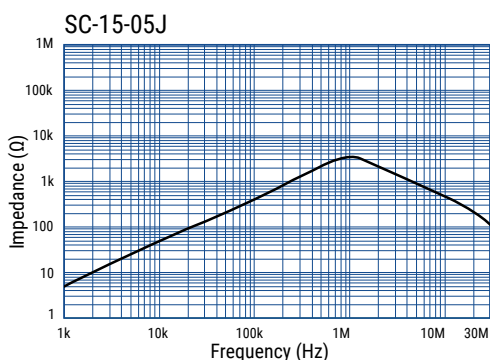
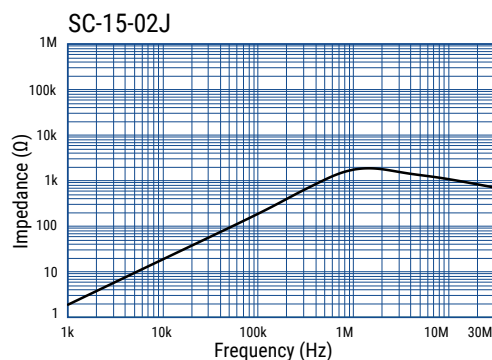
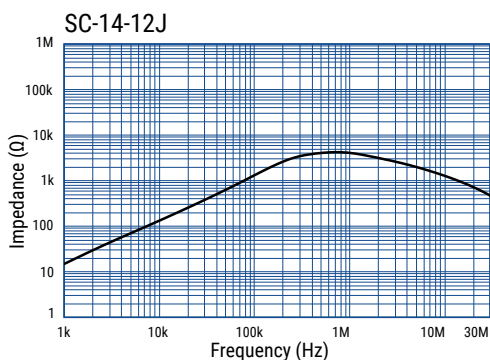
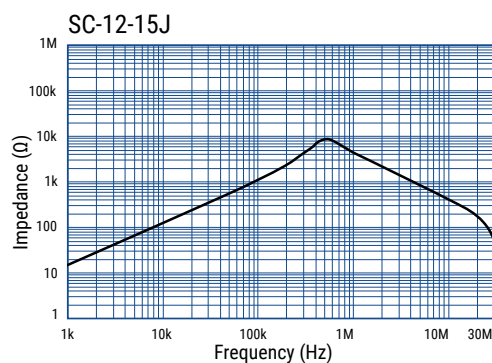
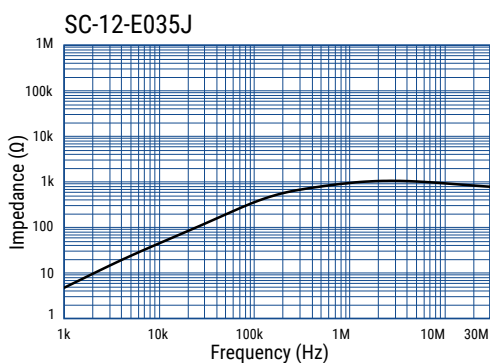
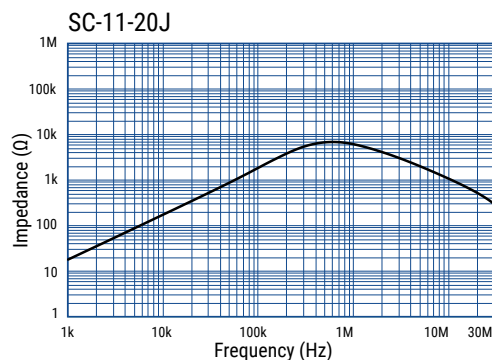
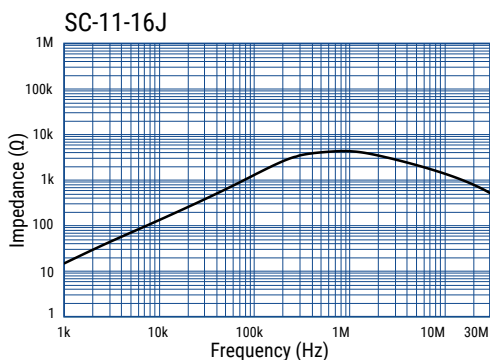

## Frequency Characteristics cont.

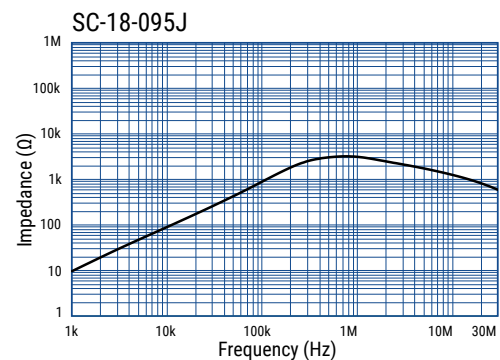
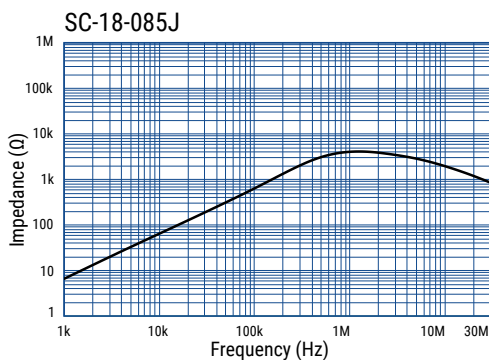
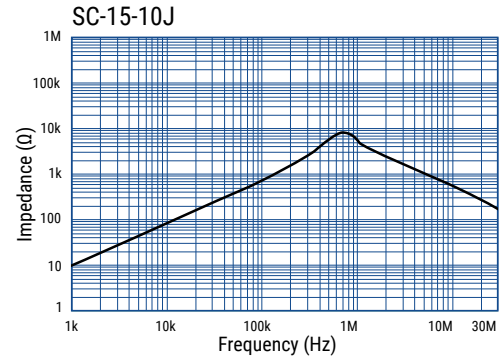
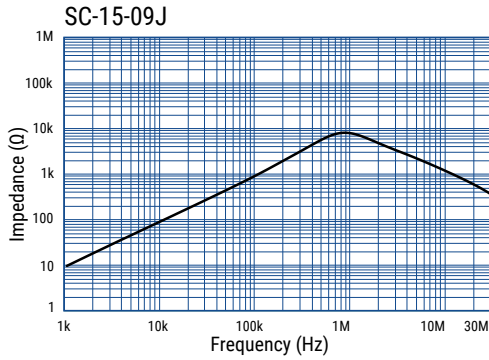



## Frequency Characteristics cont.



## Packaging

| Type          | Packaging Type | Pieces Per Box |
|---------------|----------------|----------------|
| SC-02-10J     | Tray           | 400            |
| SC-02-20J     |                |                |
| SC-02-30J     |                |                |
| SC-02-50J     |                |                |
| SC-02-70J     |                |                |
| SC-02-100J    |                |                |
| SC-02-E115J   |                |                |
| SC-02-E120J   |                |                |
| SC-02-300J    |                |                |
| SC22-025-290J |                |                |
| SC-03-28J     |                |                |
| SC-03-30J     |                |                |
| SC-03-55J     |                |                |
| SC-03-67J     |                |                |
| SC-03-85J     |                |                |
| SC-04-20JN    |                |                |
| SC-05-50J     |                |                |
| SC-05-80J     |                |                |
| SC22-04-100J  |                |                |
| SC-04-200J    |                |                |
| SC-04-E17J    |                |                |
| SC-04-E50J    |                |                |
| SC-05-06J     |                |                |
| SC-05-10J     |                |                |
| SC-05-15J     |                |                |
| SC-05-21J     |                |                |
| SC-05-20J     |                |                |
| SC-05-27J     |                |                |
| SC-05-30J     |                |                |
| SC22-05-30J   |                |                |
| SC22-05-70J   |                |                |
| SC-05-100J    |                |                |
| SC-06-10J-B   |                |                |
| SC-06-35J     |                |                |
| SC-06-40J     |                |                |
| SC-06-60J     |                |                |
| SC22-06-60J   |                |                |
| SC-07-10J     |                |                |
| SC-07-30JM    |                |                |
| SC-07-42J     |                |                |

| Type         | Packaging Type | Pieces Per Box |
|--------------|----------------|----------------|
| SC-07-70J    | Tray           | 200            |
| SC-07-90J    |                |                |
| SC-07-50J    |                |                |
| SC-08-E075J  |                |                |
| SC-08-20J    |                |                |
| SC-08-30J    |                |                |
| SC-08-44J    |                |                |
| SC-08-100JM  |                |                |
| SC-10-E035J  |                |                |
| SC-10-10J    |                |                |
| SC-10-14J    |                |                |
| SC-10-15J-MI |                |                |
| SC-10-18J    |                |                |
| SC-10-20J    |                |                |
| SC-10-30J    |                |                |
| SC-10-E55J   |                |                |
| SC-11-16J    |                |                |
| SC-11-20J    |                |                |
| SC-12-E035J  |                |                |
| SC-12-15J    |                |                |
| SC-14-12J    |                |                |
| SC-15-02J    |                |                |
| SC-15-05J    |                |                |
| SC-15-07J    |                |                |
| SC-15-09J    |                |                |
| SC-15-10J    |                |                |
| SC-15-12J-MI |                |                |
| SC-15-E37J   |                |                |
| SC-18-05J    |                |                |
| SC-18-10J    |                |                |
| SC-18-085J   |                |                |
| SC-18-095J   |                |                |
| SC-18-E12J   |                |                |
| SC-18-E15J   |                |                |
| SC-18-25J    |                |                |
| SC-20-01J-A  |                |                |
| SC-20-03J    |                |                |
| SC-20-05J-P  |                |                |
| SC-20-E085JM |                |                |
| SC-20-E18J   |                |                |

## Handling Precautions

### Precautions for product storage

AC Line Filters should be stored in normal working environments. While the chokes themselves are quite robust in other environments, solderability will be degraded by exposure to high temperatures, high humidity, corrosive atmospheres, and long term storage.

KEMET recommends that maximum storage temperature not exceed 40°C and maximum storage humidity not exceed 70% relative humidity. Atmospheres should be free of chlorine and sulfur bearing compounds. Temperature fluctuations should be minimized to avoid condensation on the parts. Avoid storage near strong magnetic fields, as this might magnetize the product.

For optimized solderability, AC line filters stock should be used promptly and preferably within 6 months of receipt.

### Product temperature rise values

The values listed for temperature rise are the result of self-heating in wires when the rated current (commercial frequency) is applied.

When using the product, check and evaluate the value of the core temperature rise under actual operating conditions.

## KEMET Electronics Corporation Sales Offices

For a complete list of our global sales offices, please visit [www.kemet.com/sales](http://www.kemet.com/sales).

---

### Disclaimer

All product specifications, statements, information and data (collectively, the "Information") in this datasheet are subject to change. The customer is responsible for checking and verifying the extent to which the Information contained in this publication is applicable to an order at the time the order is placed. All Information given herein is believed to be accurate and reliable, but it is presented without guarantee, warranty, or responsibility of any kind, expressed or implied.

Statements of suitability for certain applications are based on KEMET Electronics Corporation's ("KEMET") knowledge of typical operating conditions for such applications, but are not intended to constitute – and KEMET specifically disclaims – any warranty concerning suitability for a specific customer application or use. The Information is intended for use only by customers who have the requisite experience and capability to determine the correct products for their application. Any technical advice inferred from this Information or otherwise provided by KEMET with reference to the use of KEMET's products is given gratis, and KEMET assumes no obligation or liability for the advice given or results obtained.

Although KEMET designs and manufactures its products to the most stringent quality and safety standards, given the current state of the art, isolated component failures may still occur. Accordingly, customer applications which require a high degree of reliability or safety should employ suitable designs or other safeguards (such as installation of protective circuitry or redundancies) in order to ensure that the failure of an electrical component does not result in a risk of personal injury or property damage.

Although all product-related warnings, cautions and notes must be observed, the customer should not assume that all safety measures are indicated or that other measures may not be required.

When providing KEMET products and technologies contained herein to other countries, the customer must abide by the procedures and provisions stipulated in all applicable export laws and regulations, including without limitation the International Traffic in Arms Regulations (ITAR), the US Export Administration Regulations (EAR) and the Japan Foreign Exchange and Foreign Trade Act.

*KEMET is a registered trademark of KEMET Electronics Corporation.*



Компания «ЭлектроПласт» предлагает заключение долгосрочных отношений при поставках импортных электронных компонентов на взаимовыгодных условиях!

Наши преимущества:

- Оперативные поставки широкого спектра электронных компонентов отечественного и импортного производства напрямую от производителей и с крупнейших мировых складов;
- Поставка более 17-ти миллионов наименований электронных компонентов;
- Поставка сложных, дефицитных, либо снятых с производства позиций;
- Оперативные сроки поставки под заказ (от 5 рабочих дней);
- Экспресс доставка в любую точку России;
- Техническая поддержка проекта, помощь в подборе аналогов, поставка прототипов;
- Система менеджмента качества сертифицирована по Международному стандарту ISO 9001;
- Лицензия ФСБ на осуществление работ с использованием сведений, составляющих государственную тайну;
- Поставка специализированных компонентов (Xilinx, Altera, Analog Devices, Intersil, Interpoint, Microsemi, Aeroflex, Peregrine, Syfer, Eurofarad, Texas Instrument, Miteq, Cobham, E2V, MA-COM, Hittite, Mini-Circuits, General Dynamics и др.);

Помимо этого, одним из направлений компании «ЭлектроПласт» является направление «Источники питания». Мы предлагаем Вам помощь Конструкторского отдела:

- Подбор оптимального решения, техническое обоснование при выборе компонента;
- Подбор аналогов;
- Консультации по применению компонента;
- Поставка образцов и прототипов;
- Техническая поддержка проекта;
- Защита от снятия компонента с производства.



#### Как с нами связаться

**Телефон:** 8 (812) 309 58 32 (многоканальный)

**Факс:** 8 (812) 320-02-42

**Электронная почта:** [org@eplast1.ru](mailto:org@eplast1.ru)

**Адрес:** 198099, г. Санкт-Петербург, ул. Калинина, дом 2, корпус 4, литера А.