

## Optocoupler, Phototransistor Output, with Base Connection in SOIC-8

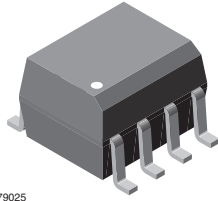

i179025

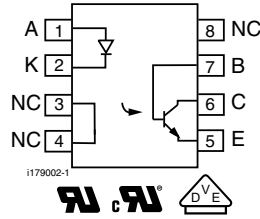

### FEATURES

- Isolation test voltage, 4000 V<sub>RMS</sub>
- Industry standard SOIC-8 surface mountable package
- Compatible with dual wave, vapor phase and IR reflow soldering
- Compliant to RoHS Directive 2002/95/EC and in accordance to WEEE 2002/96/EC



**RoHS**  
COMPLIANT

### DESCRIPTION

The IL211AT, IL212AT, IL213AT are optically coupled pairs with a gallium arsenide infrared LED and silicon NPN phototransistor. Signal information, including a DC level, can be transmitted by the device while maintaining a high degree of electrical isolation between input and output.

The IL211AT, IL212AT, IL213AT comes in a standard SOIC-8 small outline package for surface mounting which makes it ideally suited for high density applications with limited space. In addition to eliminating through-holes requirements, this package conforms to standards for surface mounted devices.

A choice of 20 %, 50 %, and 100 % minimum CTR at I<sub>F</sub> = 10 mA makes these optocouplers suitable for a variety of different applications.

### AGENCY APPROVALS

- UL1577, file no. E52744 system code Y
- cUL - file no. E52744, equivalent to CSA bulletin A5
- DIN EN 60747-5-2 (VDE 0884) <sup>(1)</sup>
- DIN EN 60747-5-5 (pending) <sup>(1)</sup>

#### Note

<sup>(1)</sup> Available upon request, as option 1

### ORDERING INFORMATION

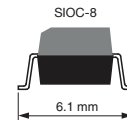
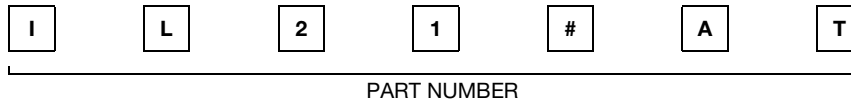

AGENCY CERTIFIED/PACKAGE	CTR (%)		
	10 mA		
UL, cUL	> 20	> 50	> 100
SIOC-8	IL211AT	IL212AT	IL213AT

### ABSOLUTE MAXIMUM RATINGS (T<sub>amb</sub> = 25 °C, unless otherwise specified)

PARAMETER	TEST CONDITION	SYMBOL	VALUE	UNIT
<b>INPUT</b>				
Peak reverse voltage		V <sub>R</sub>	6	V
Forward continuous current		I <sub>F</sub>	60	mA
Power dissipation		P <sub>diss</sub>	90	mW
Derate linearly from 25 °C			1.2	mW/°C
<b>OUTPUT</b>				
Collector emitter breakdown voltage		BV <sub>CEO</sub>	30	V
Emitter collector breakdown voltage		BV <sub>ECO</sub>	7	V
Collector base breakdown voltage		V <sub>CBO</sub>	70	V
I <sub>C</sub> MAX DC		I <sub>C</sub> MAX DC	50	mA
I <sub>C</sub> MAX	t < 1 ms	I <sub>C</sub> MAX	100	mA
Power dissipation		P <sub>diss</sub>	150	mW
Derate linearly from 25 °C			2	mW/°C

# IL211AT, IL212AT, IL213AT



Vishay Semiconductors Optocoupler, Phototransistor Output,  
with Base Connection in SOIC-8 Package

<b>ABSOLUTE MAXIMUM RATINGS</b> ( $T_{amb} = 25\text{ }^{\circ}\text{C}$ , unless otherwise specified)				
PARAMETER	TEST CONDITION	SYMBOL	VALUE	UNIT
<b>COUPLER</b>				
Isolation test voltage		$V_{ISO}$	4000	$V_{RMS}$
Total package dissipation	LED and detector	$P_{tot}$	240	mW
Derate linearly from 25 °C			3.2	mW/°C
Storage temperature		$T_{stg}$	- 55 to + 150	°C
Operating temperature		$T_{amb}$	- 55 to + 100	°C
Soldering time	at 260 °C		10	s

## Note

- Stresses in excess of the absolute maximum ratings can cause permanent damage to the device. Functional operation of the device is not implied at these or any other conditions in excess of those given in the operational sections of this document. Exposure to absolute maximum ratings for extended periods of the time can adversely affect reliability.

<b>ELECTRICAL CHARACTERISTICS</b> ( $T_{amb} = 25\text{ }^{\circ}\text{C}$ , unless otherwise specified)							
PARAMETER	TEST CONDITION	PART	SYMBOL	MIN.	TYP.	MAX.	UNIT
<b>INPUT</b>							
Forward voltage	$I_F = 10\text{ mA}$		$V_F$		1.3	1.5	V
Reverse current	$V_R = 6\text{ V}$		$I_R$		0.1	100	$\mu\text{A}$
Capacitance	$V_R = 0\text{ V}$		$C_O$		13		pF
<b>OUTPUT</b>							
Collector emitter breakdown voltage	$I_C = 10\text{ }\mu\text{A}$		$BV_{CEO}$	30			V
Emitter collector breakdown voltage	$I_E = 10\text{ }\mu\text{A}$		$BV_{ECO}$	7			V
Collector dark current	$V_{CE} = 10\text{ V}$		$I_{CEO}$		5	50	nA
Collector emitter capacitance	$V_{CE} = 0\text{ V}$		$C_{CE}$		10		pF
<b>COUPLER</b>							
Saturation voltage, collector emitter	$I_F = 10\text{ mA}$		$V_{CEsat}$			0.4	V
Isolation test voltage	1 s		$V_{ISO}$	4000			$V_{RMS}$
Capacitance (input to output)			$C_{IO}$		0.5	50	pF
Resistance (input to output)			$R_{IO}$		100		G $\Omega$
Collector emitter breakdown voltage	$I_C = 10\text{ }\mu\text{A}$		$BV_{CEO}$	30			V

## Note

- Minimum and maximum values were tested requirements. Typical values are characteristics of the device and are the result of engineering evaluations. Typical values are for information only and are not part of the testing requirements.

<b>CURRENT TRANSFER RATIO</b>							
PARAMETER	TEST CONDITION	PART	SYMBOL	MIN.	TYP.	MAX.	UNIT
Current transfer ratio	$I_F = 10\text{ mA}$ , $V_{CE} = 5\text{ V}$	IL211AT	CTR	20	50		%
		IL212AT	CTR	50	80		%
		IL213AT	CTR	100	130		%

<b>SWITCHING CHARACTERISTICS</b>							
PARAMETER	TEST CONDITION	PART	SYMBOL	MIN.	TYP.	MAX.	UNIT
Switching time	$I_C = 2\text{ mA}$ , $R_L = 100\text{ }\Omega$ , $V_{CC} = 10\text{ V}$		$t_{on}$ , $t_{off}$		3		$\mu\text{s}$



SAFETY AND INSULATION RATINGS						
PARAMETER	TEST CONDITION	SYMBOL	MIN.	TYP.	MAX.	UNIT
Climatic classification (according to IEC 68 part 1)				55/100/21		
Comparative tracking index		CTI	175		399	
$V_{IOTM}$			6000			V
$V_{IORM}$			560			V
$P_{SO}$					350	mW
$I_{SI}$					150	mA
$T_{SI}$					165	°C
Creepage distance			4			mm
Clearance distance			4			mm
Insulation thickness			0.2			mm

**Note**

- As per IEC 60747-5-2, § 7.4.3.8.1, this optocoupler is suitable for “Safe Electrical Insulation” only within the safety ratings. Compliance with the safety ratings shall be ensured by means of protective circuits.

**TYPICAL CHARACTERISTICS** ( $T_{amb} = 25\text{ °C}$ , unless otherwise specified)

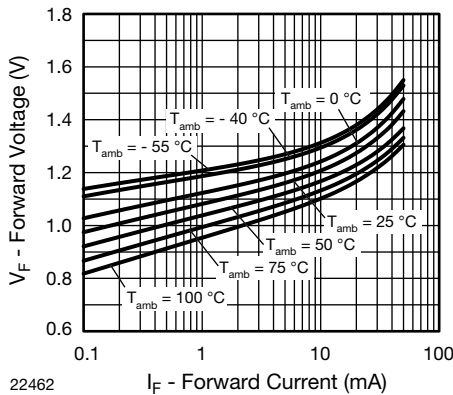

Fig. 1 - Forward Voltage vs. Forward Current

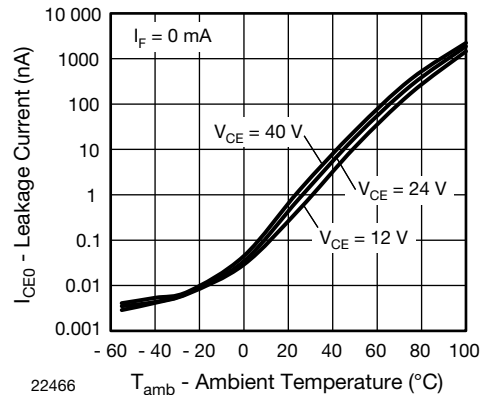

Fig. 3 - Leakage Current vs. Ambient Temperature

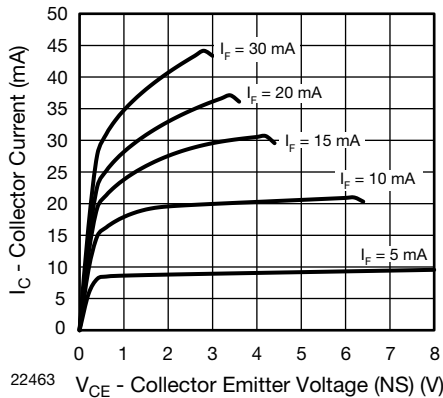

Fig. 2 - Collector Current vs. Collector Emitter Voltage (NS)

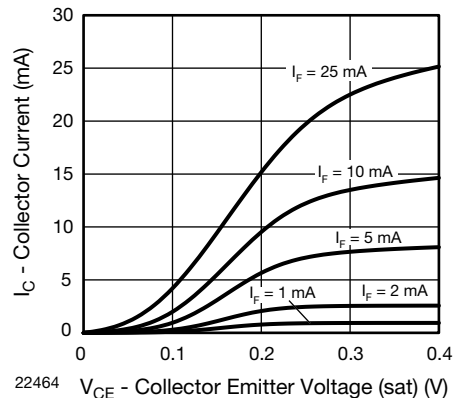

Fig. 4 - Collector Current vs. Collector Emitter Voltage (sat)

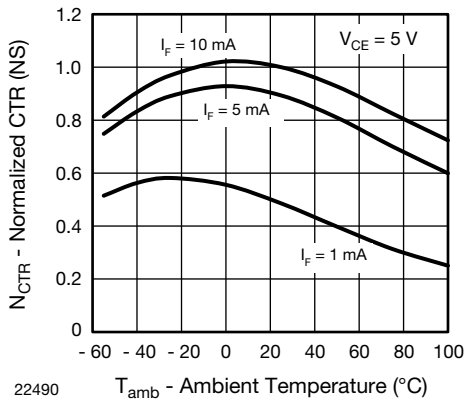

Fig. 5 - Normalized CTR (NS) vs. Ambient Temperature

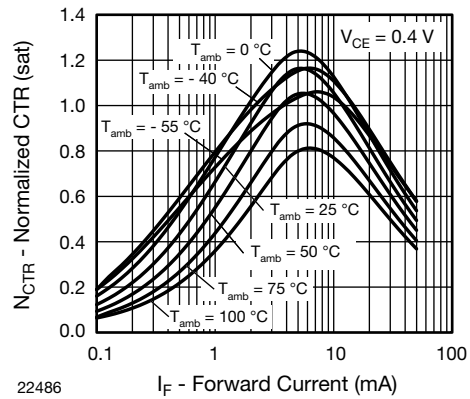

Fig. 8 - Normalized CTR (sat) vs. Forward Current

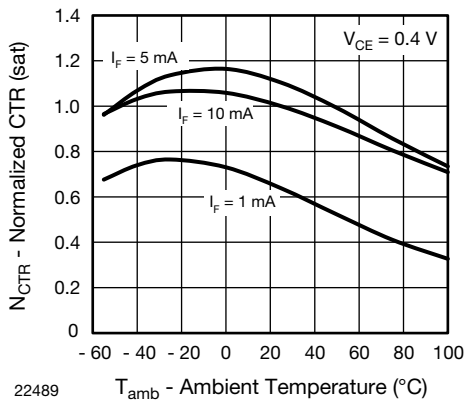

Fig. 6 - Normalized CTR (sat) vs. Ambient Temperature

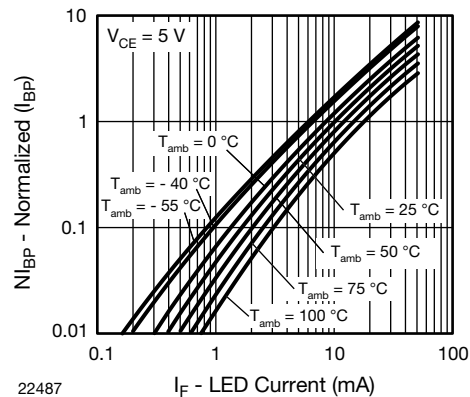

Fig. 9 - Normalized Photocurrent vs. LED Current

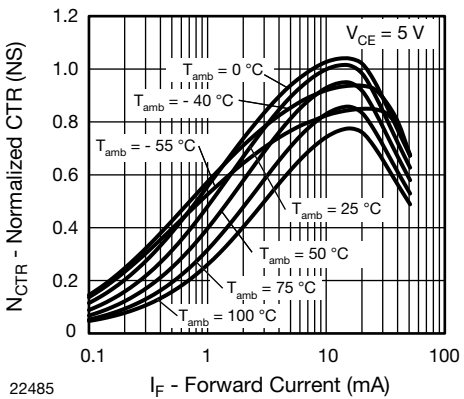

Fig. 7 - Normalized CTR (NS) vs. Forward Current

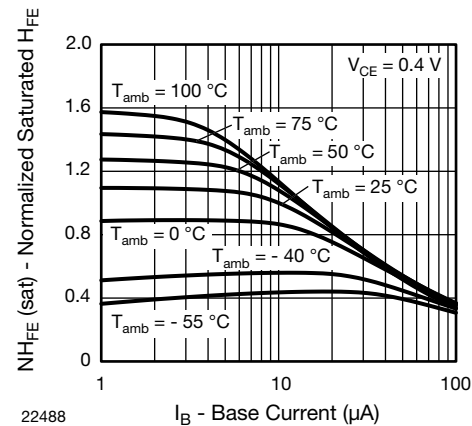
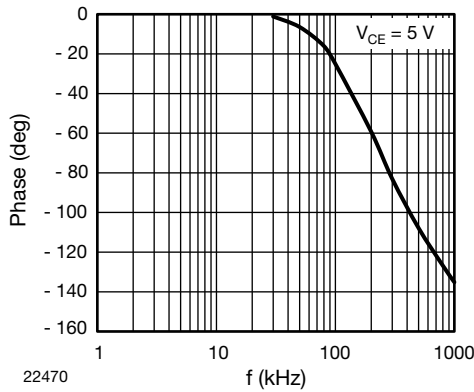

Fig. 10 - Normalized Saturated  $H_{FE}$  vs. Base Current



# IL211AT, IL212AT, IL213AT

Optocoupler, Phototransistor Output, Vishay Semiconductors  
with Base Connection in SOIC-8 Package



22470

Fig. 11 -  $F_{CTR}$  vs. Phase Angle

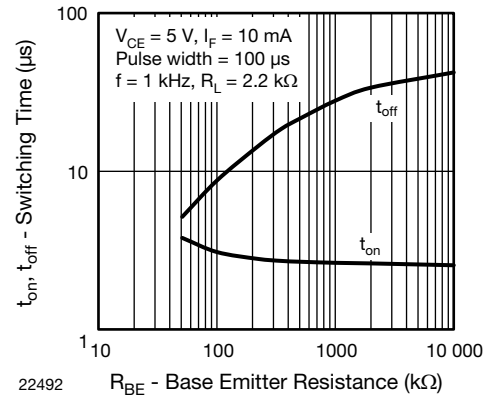

22492

Fig. 14 - Switching Time vs. Base Emitter Resistance

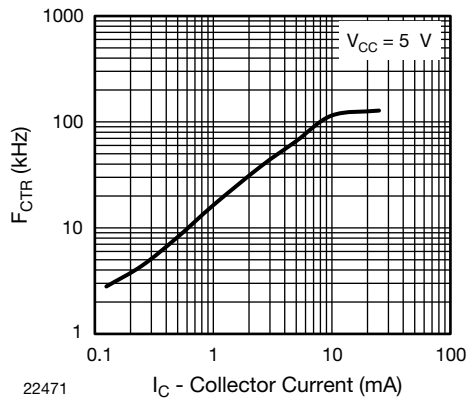

22471

Fig. 12 -  $F_{CTR}$  vs.  $I_C$

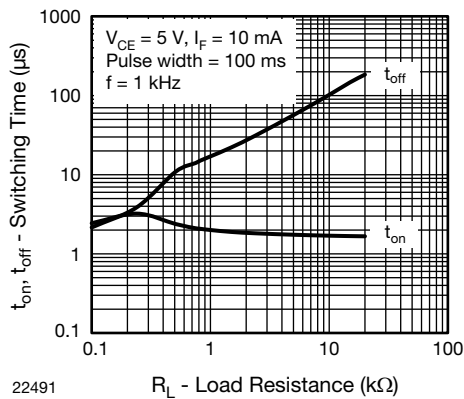

22491

Fig. 13 - Switching Time vs. Load Resistance

# IL211AT, IL212AT, IL213AT



Vishay Semiconductors Optocoupler, Phototransistor Output,  
with Base Connection in SOIC-8 Package

## PACKAGE DIMENSIONS in millimeters

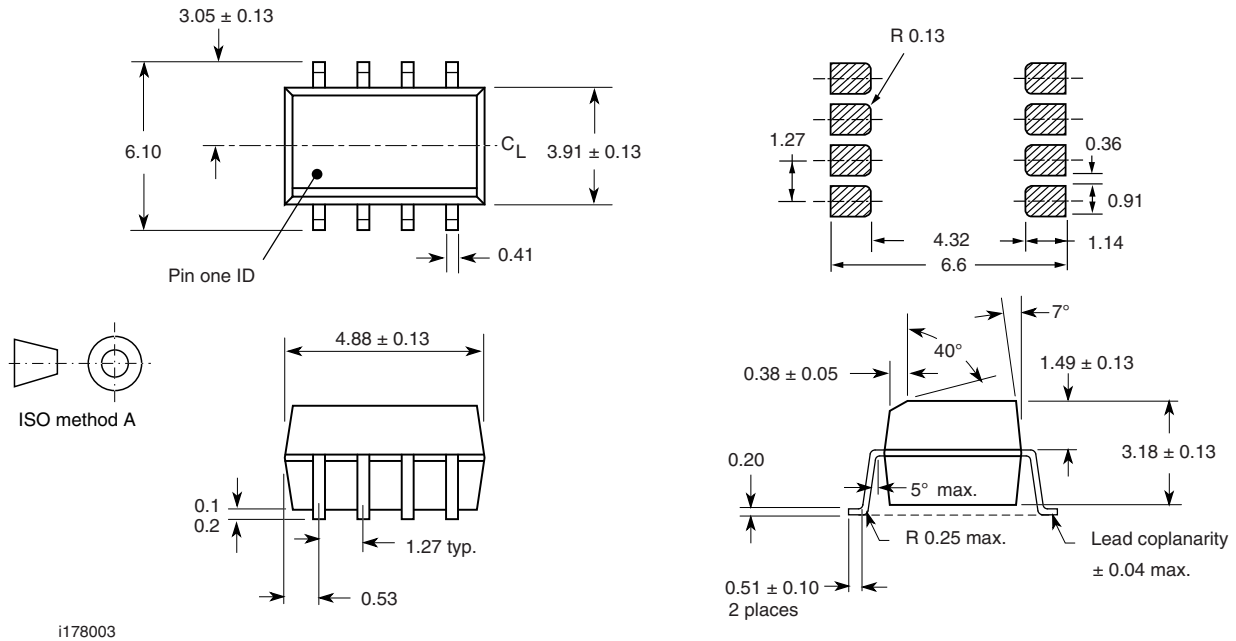

## PACKAGE MARKING (example)

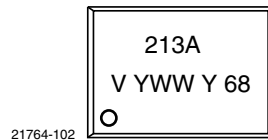



## Disclaimer

ALL PRODUCT, PRODUCT SPECIFICATIONS AND DATA ARE SUBJECT TO CHANGE WITHOUT NOTICE TO IMPROVE RELIABILITY, FUNCTION OR DESIGN OR OTHERWISE.

Vishay Intertechnology, Inc., its affiliates, agents, and employees, and all persons acting on its or their behalf (collectively, "Vishay"), disclaim any and all liability for any errors, inaccuracies or incompleteness contained in any datasheet or in any other disclosure relating to any product.

Vishay makes no warranty, representation or guarantee regarding the suitability of the products for any particular purpose or the continuing production of any product. To the maximum extent permitted by applicable law, Vishay disclaims (i) any and all liability arising out of the application or use of any product, (ii) any and all liability, including without limitation special, consequential or incidental damages, and (iii) any and all implied warranties, including warranties of fitness for particular purpose, non-infringement and merchantability.

Statements regarding the suitability of products for certain types of applications are based on Vishay's knowledge of typical requirements that are often placed on Vishay products in generic applications. Such statements are not binding statements about the suitability of products for a particular application. It is the customer's responsibility to validate that a particular product with the properties described in the product specification is suitable for use in a particular application. Parameters provided in datasheets and/or specifications may vary in different applications and performance may vary over time. All operating parameters, including typical parameters, must be validated for each customer application by the customer's technical experts. Product specifications do not expand or otherwise modify Vishay's terms and conditions of purchase, including but not limited to the warranty expressed therein.

Except as expressly indicated in writing, Vishay products are not designed for use in medical, life-saving, or life-sustaining applications or for any other application in which the failure of the Vishay product could result in personal injury or death. Customers using or selling Vishay products not expressly indicated for use in such applications do so at their own risk. Please contact authorized Vishay personnel to obtain written terms and conditions regarding products designed for such applications.

No license, express or implied, by estoppel or otherwise, to any intellectual property rights is granted by this document or by any conduct of Vishay. Product names and markings noted herein may be trademarks of their respective owners.

## Material Category Policy

**Vishay Intertechnology, Inc. hereby certifies that all its products that are identified as RoHS-Compliant fulfill the definitions and restrictions defined under Directive 2011/65/EU of The European Parliament and of the Council of June 8, 2011 on the restriction of the use of certain hazardous substances in electrical and electronic equipment (EEE) - recast, unless otherwise specified as non-compliant.**

**Please note that some Vishay documentation may still make reference to RoHS Directive 2002/95/EC. We confirm that all the products identified as being compliant to Directive 2002/95/EC conform to Directive 2011/65/EU.**

**Vishay Intertechnology, Inc. hereby certifies that all its products that are identified as Halogen-Free follow Halogen-Free requirements as per JEDEC JS709A standards. Please note that some Vishay documentation may still make reference to the IEC 61249-2-21 definition. We confirm that all the products identified as being compliant to IEC 61249-2-21 conform to JEDEC JS709A standards.**



Компания «ЭлектроПласт» предлагает заключение долгосрочных отношений при поставках импортных электронных компонентов на взаимовыгодных условиях!

Наши преимущества:

- Оперативные поставки широкого спектра электронных компонентов отечественного и импортного производства напрямую от производителей и с крупнейших мировых складов;
- Поставка более 17-ти миллионов наименований электронных компонентов;
- Поставка сложных, дефицитных, либо снятых с производства позиций;
- Оперативные сроки поставки под заказ (от 5 рабочих дней);
- Экспресс доставка в любую точку России;
- Техническая поддержка проекта, помощь в подборе аналогов, поставка прототипов;
- Система менеджмента качества сертифицирована по Международному стандарту ISO 9001;
- Лицензия ФСБ на осуществление работ с использованием сведений, составляющих государственную тайну;
- Поставка специализированных компонентов (Xilinx, Altera, Analog Devices, Intersil, Interpoint, Microsemi, Aeroflex, Peregrine, Syfer, Eurofarad, Texas Instrument, Miteq, Cobham, E2V, MA-COM, Hittite, Mini-Circuits, General Dynamics и др.);

Помимо этого, одним из направлений компании «ЭлектроПласт» является направление «Источники питания». Мы предлагаем Вам помощь Конструкторского отдела:

- Подбор оптимального решения, техническое обоснование при выборе компонента;
- Подбор аналогов;
- Консультации по применению компонента;
- Поставка образцов и прототипов;
- Техническая поддержка проекта;
- Защита от снятия компонента с производства.



#### Как с нами связаться

**Телефон:** 8 (812) 309 58 32 (многоканальный)

**Факс:** 8 (812) 320-02-42

**Электронная почта:** [org@eplast1.ru](mailto:org@eplast1.ru)

**Адрес:** 198099, г. Санкт-Петербург, ул. Калинина, дом 2, корпус 4, литера А.