

SMD/BLOCK Type EMI Suppression Filters

EMIFIL[®]



*Innovator
in Electronics*

**Murata
Manufacturing Co., Ltd.**

△Note • Please read rating and △CAUTION (for storage, operating, rating, soldering, mounting and handling) in this catalog to prevent smoking and/or burning, etc.
• This catalog has only typical specifications because there is no space for detailed specifications. Therefore, please review our product specifications or consult the approval sheet for product specifications before ordering.

C31E.pdf
Mar.28,2011



Chip EMIFIL®

Series Introduction	102
Part Numbering	104
Series Line Up	107
Product Detail	110
⚠Caution/Notice	138
Soldering and Mounting	139
Packaging	145
Design Kits	146

⚠Note • Please read rating and ⚠CAUTION (for storage, operating, rating, soldering, mounting and handling) in this catalog to prevent smoking and/or burning, etc.
• This catalog has only typical specifications because there is no space for detailed specifications. Therefore, please review our product specifications or consult the approval sheet for product specifications before ordering.



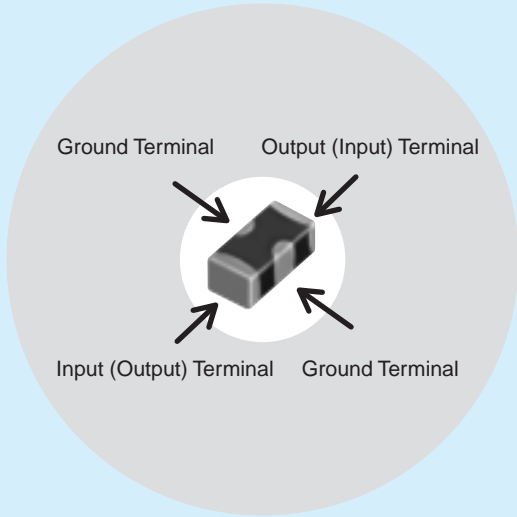











NF Series Introduction



Example of 3 Terminal Capacitor Structure

Chip 3 terminal capacitor is chip shaped 3 terminal capacitor designed for noise suppression. Its inner structure like feed through capacitor makes its ground impedance quite low. Owing to this structure, 3 terminal capacitor has good noise suppression effect at high frequency range up to several hundred MHz.



Series	Equivalent Circuit	Part Number	
NFM Series (3 terminal capacitor)		 NFM18CC	
		 NFM21CC	
		 NFM18PC	
		 NFM18PS	
		 NFM21PC	
NFL / NFW Series (LC filter)		 NFL18ST	
		 NFL18SP  NFL21SP  NFW31SP	
		 NFA21S  NFA18S	
NFR Series (RC filter)		 NFR21GD  NFA31GD	
NFE Series (Feed through capacitor with ferrite cores)		 NFE31PT  NFE61PT	

△Note • Please read rating and △CAUTION (for storage, operating, rating, soldering, mounting and handling) in this catalog to prevent smoking and/or burning, etc.
 • This catalog has only typical specifications because there is no space for detailed specifications. Therefore, please review our product specifications or consult the approval sheet for product specifications before ordering.

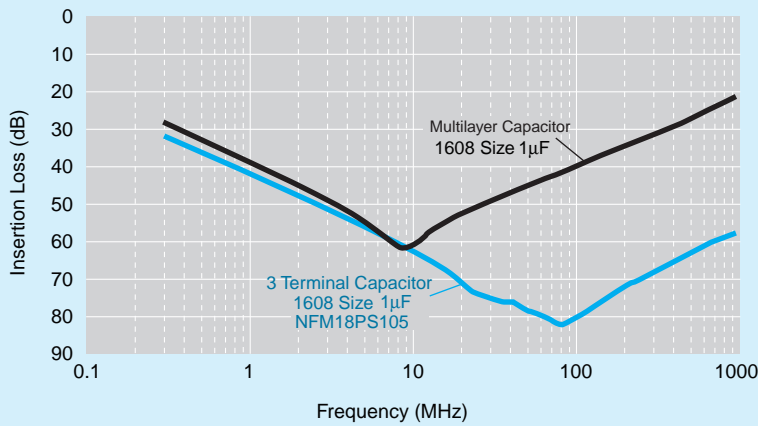

Insertion Loss Sample	Features	Classification		Applications	Example
		Code	Description		Details
	Standard of 3 terminal capacitor	NFM_CC	Standard type with varied capacitance	Noise suppression in low speed signal lines	<ul style="list-style-type: none"> Low speed interface lines, sensor
		NFM_PC	Meet large current, high capacitance available, for power lines	Noise suppression in power lines	<ul style="list-style-type: none"> Individual IC power lines
	Sharp insertion loss curve enables low damage to signal waveform	NFL_ST	T-type filter, effective in low impedance circuits	Noise suppression in high speed signal lines	<ul style="list-style-type: none"> High speed interface lines Bus lines LCD lines Camera I/Fs High speed analog lines RGB / D terminal
		NFL_SP	π -type filter, effective in high impedance circuits		
		NFW_SP	π -type filter, designed for low impedance circuits		
		NFA_SL	4-line array, suitable for bus lines or flat cables		
	Limit noise using resistor, also loop back to ground			Noise suppression in signal line with unstable ground	<ul style="list-style-type: none"> Interface lines Clock lines
	Meet large current, good high frequency performance because of its feed through structure			Noise suppression in power lines / low impedance lines	<ul style="list-style-type: none"> Various power lines sensor

△Note • Please read rating and △CAUTION (for storage, operating, rating, soldering, mounting and handling) in this catalog to prevent smoking and/or burning, etc.
 • This catalog has only typical specifications because there is no space for detailed specifications. Therefore, please review our product specifications or consult the approval sheet for product specifications before ordering.

NF Chip EMIFIL[®] Part Numbering

Capacitor

(Part Number)

NF	M	3D	CC	102	R	1H	3	L
①	②	③	④	⑤	⑥	⑦	⑧	⑨

① Product ID

Product ID	
NF	Chip EMIFIL [®]

② Structure

Code	Structure
M	Capacitor Type
A	Capacitor Array Type

③ Dimensions (L×W)

Code	Dimensions (L×W)	EIA
18	1.6×0.8mm	0603
21	2.0×1.25mm	0805
3D	3.2×1.25mm	1205
31	3.2×1.6mm	1206
41	4.5×1.6mm	1806
55	5.7×5.0mm	2220

④ Features

Code	Features
CC	Capacitor Type for Signal Lines
PC	Capacitor Type for Large Current
PS	High Loss Type for Large Current

⑤ Capacitance

Expressed by three figures. The unit is in pico-farad (pF). The first and second figures are significant digits, and the third figure expresses the number of zeros which follow the two figures.

⑨ Packaging

Code	Packaging	Series
L	Embossed Taping (ø180mm Reel)	NFM3D/NFM31/NFM41/NFM55
B	Bulk	All series
D	Paper Taping (ø180mm Reel)	NFM18/NFM21/NFA□□CC

⑥ Characteristics

Code	Capacitance Change (Temperature Characteristics)
B	±10%, ±12.5%, +10/-13%
F	+30/-80%, +30/-84%
R	±15%, +15/-18%
U	-750 ±120ppm/°C
S	+350 to -1000ppm/°C

⑦ Rated Voltage

Code	Rated Voltage
0J	6.3V
1A	10V
1C	16V
1E	25V
1H	50V
2A	100V

⑧ Electrode/Others (NFM Series)

Code	Electrode	Series
3	Sn Plating	NFM (Except NFM55)
4	Solder Coating	NFM55

⑧ Number of Circuits (NFA□□CC Series)

Code	Number of Circuits
4	4 Circuits

△Note • Please read rating and △CAUTION (for storage, operating, rating, soldering, mounting and handling) in this catalog to prevent smoking and/or burning, etc.
• This catalog has only typical specifications because there is no space for detailed specifications. Therefore, please review our product specifications or consult the approval sheet for product specifications before ordering.

LC Combined (1)

(Part Number)

NF	L	18	ST	107	X	1C	3	L
①	②	③	④	⑤	⑥	⑦	⑧	⑨

① Product ID

Product ID	
NF	Chip EMIFIL®

② Structure

Code	Structure
L	Multilayer, LC Combined Type
W	Wire Wound, LC Combined Type
E	Block, LC Combined Type

③ Dimensions (L×W)

Code	Dimensions (L×W)	EIA
18	1.6×0.8mm	0603
21	2.0×1.25mm	0805
31	3.2×1.6mm	1206
61	6.8×1.6mm	2606

④ Features

Code	Features
SP	π Circuit for Signal Lines
ST	T Circuit for Signal Lines
PT	T Circuit for Large Current

⑤ Cut-off Frequency (NFL/NFW Series)

Expressed by three figures. The unit is in hertz (Hz). The first and second figures are significant digits, and the third figure expresses the number of zeros which follow the two figures.

⑤ Capacitance (NFE Series)

Expressed by three figures. The unit is in pico-farad (pF). The first and second figures are significant digits, and the third figure expresses the number of zeros which follow the two figures.

⑨ Packaging

Code	Packaging	Series
K	Embossed Taping (ø330mm Reel)	NFW31/NFE
L	Embossed Taping (ø180mm Reel)	NFW31/NFE
B	Bulk	NFL18/NFL21/NFE
D	Paper Taping (ø180mm Reel)	NFL18/NFL21

⑥ Characteristics (NFL/NFW Series)

Code	Characteristics
X	Cut-off Frequency

⑥ Characteristics (NFE Series)

Code	Capacitance Change (Temperature Characteristics)
B	±10%
C	±20%, ±22%
D	+20/-30%, +22/-33%
E	+20/-55%, +22/-56%
F	+30/-80%, +22/-82%
R	±15%
U	-750 ±120ppm/ °C
Z	Other

⑦ Rated Voltage

Code	Rated Voltage
1A	10V
1C	16V
1E	25V
1H	50V
2A	100V

⑧ Electrode

Code	Electrode	Series
3/7	Sn Plating	NFL
4	Lead Free Solder Coating	NFW
9	Others	NFE

△Note • Please read rating and △CAUTION (for storage, operating, rating, soldering, mounting and handling) in this catalog to prevent smoking and/or burning, etc.
• This catalog has only typical specifications because there is no space for detailed specifications. Therefore, please review our product specifications or consult the approval sheet for product specifications before ordering.

LC Combined (2)



① Product ID

Product ID	
NF	Chip EMIFIL®

② Structure

Code	Structure
A	Array Type

③ Dimensions (L×W)

Code	Dimensions (L×W)	EIA
18	1.6×0.8mm	0603
21	2.0×1.25mm	0805

④ Features (1)

Code	Features
SL	L Circuit for Signal Lines
SD	L Circuit for Differential Signal

⑤ Cut-off Frequency

Expressed by three figures. The unit is in hertz (Hz). The first and second figures are significant digits, and the third figure expresses the number of zeros which follow the two figures.

⑥ Features (2)

Code	Features
X	Expressed by a letter
V	

⑦ Rated Voltage

Code	Rated Voltage
1A	10V

⑧ Number of Circuits

Code	Number of Circuits
4	4 Circuits

⑨ Dimensions (T)

Code	Dimensions (T)
5	Low Profile
8	Standard

⑩ Packaging

Code	Packaging
B	Bulk
L	Embossed Taping (ø180mm Reel)

RC Combined

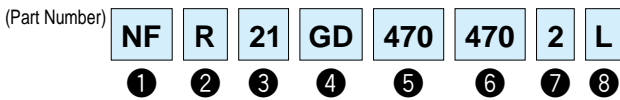

① Product ID

Product ID	
NF	Chip EMIFIL®

② Structure

Code	Structure
R	RC Combined Type
A	RC Combined Array Type

③ Dimensions (L×W)

Code	Dimensions (L×W)	EIA
21	2.0×1.25mm	0805
31	3.2×1.6mm	1206

④ Features

Code	Features
GD	RC Combined Type for Signal Lines

⑧ Packaging

Code	Packaging	Series
L	Embossed Taping (ø180mm Reel)	NFR
B	Bulk	All Series
D	Paper Taping (ø180mm Reel)	NFA□□GD

⑤ Capacitance

Expressed by three figures. The unit is in pico-farad (pF). The first and second figures are significant digits, and the third figure expresses the number of zeros which follow the two figures.

⑥ Resistance

Expressed by three-digit alphanumerics. The unit is in ohm (Ω). The first and second figures are significant digits, and the third figure expresses the number of zeros which follow the two figures. If there is a decimal point, it is expressed by the capital letter "R". In this case, all figures are significant digits.

⑦ Electrode/Others (NFR Series)

Code	Electrode
2	Sn Plating

⑦ Number of Circuits (NFA□□GD Series)

Code	Number of Circuits
4	4 Circuits

△Note • Please read rating and △CAUTION (for storage, operating, rating, soldering, mounting and handling) in this catalog to prevent smoking and/or burning, etc.
 • This catalog has only typical specifications because there is no space for detailed specifications. Therefore, please review our product specifications or consult the approval sheet for product specifications before ordering.

Type	Size Code (Inch)	Thickness (mm)	Part Number	Rated Voltage	Capacitance	Nominal Cut-off Frequency	Rated Current	New	Kit	≥1A	≥3A	DTV	Flow	ReFlow					
Capacitor Type for Signal Lines	p120	0.6	NFM18CC220U1C3	16Vdc	22pF+20%-20%	-	400mA		Kit					ReFlow					
			NFM18CC470U1C3	16Vdc	47pF+20%-20%	-	400mA		Kit						ReFlow				
			NFM18CC101R1C3	16Vdc	100pF+20%-20%	-	500mA		Kit							ReFlow			
			NFM18CC221R1C3	16Vdc	220pF+20%-20%	-	500mA		Kit							ReFlow			
			NFM18CC471R1C3	16Vdc	470pF+20%-20%	-	500mA		Kit							ReFlow			
			NFM18CC102R1C3	16Vdc	1000pF+20%-20%	-	600mA		Kit							ReFlow			
			NFM18CC222R1C3	16Vdc	2200pF+20%-20%	-	700mA		Kit							ReFlow			
	p121	0.85	NFM21CC220U1H3	50Vdc	22pF+20%-20%	-	700mA		Kit	≥1A					ReFlow				
			NFM21CC470U1H3	50Vdc	47pF+20%-20%	-	700mA		Kit						ReFlow				
			NFM21CC101U1H3	50Vdc	100pF+20%-20%	-	700mA		Kit						ReFlow				
			NFM21CC221R1H3	50Vdc	220pF+20%-20%	-	700mA		Kit							ReFlow			
			NFM21CC471R1H3	50Vdc	470pF+20%-20%	-	1000mA		Kit	≥1A						ReFlow			
			NFM21CC102R1H3	50Vdc	1000pF+20%-20%	-	1000mA		Kit	≥1A						ReFlow			
			NFM21CC222R1H3	50Vdc	2200pF+20%-20%	-	1000mA		Kit	≥1A						ReFlow			
	p122	0.7	NFM3DCC220U1H3	50Vdc	22pF+50%-20%	-	300mA							Flow	ReFlow				
			NFM3DCC470U1H3	50Vdc	47pF+50%-20%	-	300mA								Flow	ReFlow			
			NFM3DCC101U1H3	50Vdc	100pF+50%-20%	-	300mA									Flow	ReFlow		
			NFM3DCC221R1H3	50Vdc	220pF+50%-20%	-	300mA										Flow	ReFlow	
			NFM3DCC471R1H3	50Vdc	470pF+50%-20%	-	300mA										Flow	ReFlow	
			NFM3DCC102R1H3	50Vdc	1000pF+50%-20%	-	300mA										Flow	ReFlow	
			NFM3DCC222R1H3	50Vdc	2200pF+50%-20%	-	300mA										Flow	ReFlow	
	p123	1.0	NFM41CC220U2A3	100Vdc	22pF+50%-20%	-	300mA									Flow	ReFlow		
			NFM41CC470U2A3	100Vdc	47pF+50%-20%	-	300mA										Flow	ReFlow	
			NFM41CC101U2A3	100Vdc	100pF+50%-20%	-	300mA										Flow	ReFlow	
			NFM41CC221U2A3	100Vdc	220pF+50%-20%	-	300mA											Flow	ReFlow
			NFM41CC471R2A3	100Vdc	470pF+50%-20%	-	300mA											Flow	ReFlow
			NFM41CC102R2A3	100Vdc	1000pF+50%-20%	-	300mA											Flow	ReFlow
			NFM41CC222R2A3	100Vdc	2200pF+50%-20%	-	300mA											Flow	ReFlow
Capacitor Array Type for Signal Lines	p124	0.8	NFA31CC220S1E4	25Vdc	22pF+20%-20%	-	200mA		Kit						ReFlow				
			NFA31CC470S1E4	25Vdc	47pF+20%-20%	-	200mA		Kit							ReFlow			
			NFA31CC101S1E4	25Vdc	100pF+20%-20%	-	200mA		Kit								ReFlow		
			NFA31CC221S1E4	25Vdc	220pF+20%-20%	-	200mA		Kit									ReFlow	
			NFA31CC471R1E4	25Vdc	470pF+20%-20%	-	200mA		Kit									ReFlow	
			NFA31CC102R1E4	25Vdc	1000pF+20%-20%	-	200mA		Kit									ReFlow	
			NFA31CC222R1E4	25Vdc	2200pF+20%-20%	-	200mA		Kit									ReFlow	
			NFA31CC223R1C4	16Vdc	22000pF+20%-20%	-	200mA		Kit									ReFlow	
Capacitor Type for Power Lines	p112	0.6	NFM18PS474R0J3	6.3Vdc	0.47μF+20%-20%	-	2A		Kit	≥1A					ReFlow				
			NFM18PS105R0J3	6.3Vdc	1.0μF+20%-20%	-	2A		Kit	≥1A						ReFlow			
	p113	0.6	NFM18PC104R1C3	16Vdc	0.1μF+20%-20%	-	2A		Kit	≥1A						ReFlow			
			NFM18PC224R0J3	6.3Vdc	0.22μF+20%-20%	-	2A		Kit	≥1A						ReFlow			
			NFM18PC474R0J3	6.3Vdc	0.47μF+20%-20%	-	2A		Kit	≥1A							ReFlow		
			NFM18PC105R0J3	6.3Vdc	1.0μF+20%-20%	-	4A		Kit	≥1A							ReFlow		
			NFM18PC225B0J3	6.3Vdc	2.2μF+20%-20%	-	2A		Kit	≥1A							ReFlow		
			NFM18PC225B1A3	10Vdc	2.2μF+20%-20%	-	4A		Kit	≥3A							ReFlow		
	p115	0.85	NFM21PC104R1E3	25Vdc	0.1μF+20%-20%	-	2A		Kit	≥1A						ReFlow			
			NFM21PC224R1C3	16Vdc	0.22μF+20%-20%	-	2A		Kit	≥1A							ReFlow		
			NFM21PC474R1C3	16Vdc	0.47μF+20%-20%	-	2A		Kit	≥1A							ReFlow		
			NFM21PC105B1A3	10Vdc	1.0μF+20%-20%	-	4A		Kit	≥3A							ReFlow		
			NFM21PC105B1C3	16Vdc	1.0μF+20%-20%	-	4A		Kit	≥3A							ReFlow		
			NFM21PC225B0J3	6.3Vdc	2.2μF+20%-20%	-	4A		Kit	≥3A							ReFlow		
	1205	p116	0.7	NFM3DPC223R1H3	50Vdc	0.022μF+20%-20%	-	2A			≥1A				Flow	ReFlow			
				NFM31PC276B0J3	6.3Vdc	27μF+20%-20%	-	6A		Kit	≥3A						Flow	ReFlow	
				p118	1.0	NFM41PC204F1H3	50Vdc	0.2μF+80%-20%	-	2A		Kit	≥1A					Flow	ReFlow
NFM41PC155B1E3						25Vdc	1.5μF+20%-20%	-	6A		Kit	≥3A						Flow	ReFlow
p119				2.2	NFM55PC155F1H4	50Vdc	1.5μF+80%-20%	-	6A			≥3A					ReFlow		

Continued on the following page.

△Note • Please read rating and △CAUTION (for storage, operating, rating, soldering, mounting and handling) in this catalog to prevent smoking and/or burning, etc.
 • This catalog has only typical specifications because there is no space for detailed specifications. Therefore, please review our product specifications or consult the approval sheet for product specifications before ordering.

NF Chip EMIFIL® Series Line Up

Type	Size Code (Inch)	Thickness (mm)	Part Number	Rated Voltage	Capacitance	Nominal Cut-off Frequency	Rated Current	New	Kit	≥1A	≥3A	DTV	Flow	ReFlow		
LC Combined Type for Power Lines and Signal Lines	p110	1.6	NFE31PT220R1E9	25Vdc	22pF+30%-30%	-	6A			≥3A				ReFlow		
		1.6	NFE31PT470C1E9	25Vdc	47pF+50%-20%	-	6A			≥3A				ReFlow		
		1.6	NFE31PT101C1E9	25Vdc	100pF+80%-20%	-	6A			≥3A				ReFlow		
		1.6	NFE31PT221D1E9	25Vdc	220pF+50%-20%	-	6A			≥3A				ReFlow		
		1.6	NFE31PT471F1E9	25Vdc	470pF+50%-20%	-	6A			≥3A				ReFlow		
		1.6	NFE31PT152Z1E9	25Vdc	1500pF+50%-20%	-	6A		Kit	≥3A				ReFlow		
	2706	p111	1.6	NFE61PT330B1H9	50Vdc	33pF+30%-30%	-	2A			≥1A			Flow	ReFlow	
			1.6	NFE61PT680B1H9	50Vdc	68pF+30%-30%	-	2A			≥1A			Flow	ReFlow	
		1.6	NFE61PT101Z1H9	50Vdc	100pF+30%-30%	-	2A			≥1A				Flow	ReFlow	
			NFE61PT181B1H9	50Vdc	180pF+30%-30%	-	2A			≥1A				Flow	ReFlow	
			NFE61PT361B1H9	50Vdc	360pF+20%-20%	-	2A			≥1A				Flow	ReFlow	
			NFE61PT681B1H9	50Vdc	680pF+30%-30%	-	2A			≥1A				Flow	ReFlow	
			NFE61PT102E1H9	50Vdc	1000pF+80%-20%	-	2A		Kit	≥1A				Flow	ReFlow	
			NFE61PT472C1H9	50Vdc	4700pF+80%-20%	-	2A		Kit	≥1A				Flow	ReFlow	
LC Combined Multilayer Type for Signal Lines	p125	0.6	NFL18ST506H1A3	10Vdc	110pF (Typ.)	50MHz	75mA	New	Kit			DTV		ReFlow		
		0.6	NFL18ST706H1A3	10Vdc	70pF (Typ.)	70MHz	75mA	New	Kit			DTV		ReFlow		
		0.6	NFL18ST107H1A3	10Vdc	50pF (Typ.)	100MHz	75mA	New	Kit			DTV		ReFlow		
	p126	0603	0.8	NFL18ST207X1C3	16Vdc	25pF+20%-20%	200MHz	150mA		Kit					ReFlow	
			0.8	NFL18ST307X1C3	16Vdc	18pF+20%-20%	300MHz	200mA		Kit					ReFlow	
		1.6	NFL18ST507X1C3	16Vdc	10pF+20%-20%	500MHz	200mA		Kit						ReFlow	
			NFL18SP157X1A3	10Vdc	34pF+20%-20%	150MHz	100mA		Kit						ReFlow	
	p127	0603	0.6	NFL18SP207X1A3	10Vdc	24pF+20%-20%	200MHz	100mA		Kit					ReFlow	
			0.6	NFL18SP307X1A3	10Vdc	19pF+20%-20%	300MHz	100mA		Kit					ReFlow	
			0.6	NFL18SP507X1A3	10Vdc	11pF+20%-20%	500MHz	100mA		Kit					ReFlow	
		0805	p128	0.85	NFL21SP106X1C3	16Vdc	670pF+20%-20%	10MHz	100mA		Kit					ReFlow
				0.85	NFL21SP206X1C7	16Vdc	240pF+20%-20%	20MHz	100mA		Kit					ReFlow
			1.6	NFL21SP506X1C3	16Vdc	84pF+20%-20%	50MHz	150mA		Kit						ReFlow
				NFL21SP706X1C3	16Vdc	76pF+20%-20%	70MHz	150mA		Kit						ReFlow
	0.85	NFL21SP107X1C3	16Vdc	44pF+20%-20%	100MHz	200mA		Kit							ReFlow	
		NFL21SP157X1C3	16Vdc	28pF+20%-20%	150MHz	200mA		Kit							ReFlow	
		NFL21SP207X1C3	16Vdc	22pF+20%-20%	200MHz	250mA		Kit							ReFlow	
		NFL21SP307X1C3	16Vdc	19pF+10%-10%	300MHz	300mA		Kit							ReFlow	
		NFL21SP407X1C3	16Vdc	16pF+10%-10%	400MHz	300mA		Kit							ReFlow	
		NFL21SP507X1C3	16Vdc	12pF+10%-10%	500MHz	300mA		Kit							ReFlow	
LC Combined Array Type for Signal Lines	p129	0603	0.6	NFA18SL137V1A45	10Vdc	-	130MHz	50mA		Kit		DTV		ReFlow		
			0.6	NFA18SL187V1A45	10Vdc	-	180MHz	50mA		Kit		DTV		ReFlow		
			0.6	NFA18SL207V1A45	10Vdc	-	200MHz	50mA		Kit			DTV		ReFlow	
		1.6	NFA18SL227V1A45	10Vdc	-	220MHz	25mA		Kit			DTV			ReFlow	
			NFA18SL307V1A45	10Vdc	-	300MHz	100mA		Kit						ReFlow	
			NFA18SL357V1A45	10Vdc	-	350MHz	35mA	New	Kit						ReFlow	
			NFA18SL407V1A45	10Vdc	-	400MHz	100mA		Kit						ReFlow	
	p130	0603	0.5	NFA18SL487V1A45	10Vdc	-	480MHz	100mA		Kit					ReFlow	
			0.6	NFA18SL506X1A45	10Vdc	-	50MHz	25mA		Kit					ReFlow	
	p131	0603	0.6	NFA18SD187X1A45	10Vdc	-	180MHz	25mA		Kit		DTV			ReFlow	
			0.6	NFA18SD207X1A45	10Vdc	-	200MHz	25mA		Kit		DTV			ReFlow	
	p132	0805	0.5	NFA21SL287V1A45	10Vdc	-	280MHz	100mA		Kit					ReFlow	
			0.5	NFA21SL317V1A45	10Vdc	-	310MHz	100mA		Kit					ReFlow	
		1.6	NFA21SL337V1A45	10Vdc	-	330MHz	100mA		Kit						ReFlow	
			NFA21SL287V1A48	10Vdc	-	280MHz	100mA		Kit						ReFlow	
		0.85	NFA21SL317V1A48	10Vdc	-	310MHz	100mA		Kit						ReFlow	
			NFA21SL337V1A48	10Vdc	-	330MHz	100mA		Kit						ReFlow	
		p133	0805	0.85	NFA21SL207X1A45	10Vdc	-	200MHz	100mA		Kit					ReFlow
				0.85	NFA21SL307X1A45	10Vdc	-	300MHz	100mA		Kit					ReFlow
			1.6	NFA21SL506X1A48	10Vdc	-	50MHz	20mA		Kit						ReFlow
NFA21SL806X1A48				10Vdc	-	80MHz	20mA		Kit						ReFlow	
NFA21SL207X1A48	10Vdc			-	200MHz	100mA		Kit						ReFlow		
NFA21SL307X1A48	10Vdc			-	300MHz	100mA		Kit						ReFlow		

Continued on the following page. ↗

△Note • Please read rating and △CAUTION (for storage, operating, rating, soldering, mounting and handling) in this catalog to prevent smoking and/or burning, etc.
 • This catalog has only typical specifications because there is no space for detailed specifications. Therefore, please review our product specifications or consult the approval sheet for product specifications before ordering.



Type	Size Code (Inch)	Thickness (mm)	Part Number	Rated Voltage	Capacitance	Nominal Cut-off Frequency	Rated Current	New	Kit	≥1A	≥3A	DTV	Flow	ReFlow
LC Combined Wire Wound Type for Signal Lines	p134	1206	1.8	NFW31SP106X1E4	-	-	10MHz	-	Kit				Flow	ReFlow
			1.8	NFW31SP206X1E4	-	-	20MHz	-	Kit				Flow	ReFlow
			1.8	NFW31SP506X1E4	-	-	50MHz	-	Kit				Flow	ReFlow
			1.8	NFW31SP107X1E4	-	-	100MHz	-	Kit				Flow	ReFlow
			1.8	NFW31SP157X1E4	-	-	150MHz	-	Kit				Flow	ReFlow
			1.8	NFW31SP207X1E4	-	-	200MHz	-	Kit				Flow	ReFlow
			1.8	NFW31SP307X1E4	-	-	300MHz	-	Kit				Flow	ReFlow
			1.8	NFW31SP407X1E4	-	-	400MHz	-	Kit				Flow	ReFlow
RC Combined Type for Signal Lines	p136	0805	0.5	NFR21GD1002202	50Vdc	10pF+20%-20%	-	50mA						ReFlow
			0.5	NFR21GD1004702	50Vdc	10pF+20%-20%	-	35mA						ReFlow
			0.5	NFR21GD4702202	50Vdc	47pF+20%-20%	-	50mA						ReFlow
			0.5	NFR21GD4704702	50Vdc	47pF+20%-20%	-	35mA						ReFlow
			0.5	NFR21GD4706802	50Vdc	47pF+20%-20%	-	30mA						ReFlow
			0.5	NFR21GD4701012	50Vdc	47pF+20%-20%	-	25mA						ReFlow
			0.5	NFR21GD1012202	50Vdc	100pF+20%-20%	-	50mA						ReFlow
			0.5	NFR21GD1014702	50Vdc	100pF+20%-20%	-	35mA						ReFlow
			0.5	NFR21GD1016802	50Vdc	100pF+20%-20%	-	30mA						ReFlow
			0.5	NFR21GD1011012	50Vdc	100pF+20%-20%	-	25mA						ReFlow
RC Combined Array Type for Signal Lines	p137	1206	0.8	NFA31GD1006R84	6Vdc	10pF+20%-20%	-	50mA						ReFlow
			0.8	NFA31GD1004704	6Vdc	10pF+20%-20%	-	20mA						ReFlow
			0.8	NFA31GD1001014	6Vdc	10pF+20%-20%	-	15mA						ReFlow
			0.8	NFA31GD4706R84	6Vdc	47pF+20%-20%	-	50mA						ReFlow
			0.8	NFA31GD4703304	6Vdc	47pF+20%-20%	-	20mA						ReFlow
			0.8	NFA31GD4704704	6Vdc	47pF+20%-20%	-	20mA						ReFlow
			0.8	NFA31GD4701014	6Vdc	47pF+20%-20%	-	15mA						ReFlow
			0.8	NFA31GD1016R84	6Vdc	100pF+20%-20%	-	50mA						ReFlow
			0.8	NFA31GD1014704	6Vdc	100pF+20%-20%	-	20mA						ReFlow
0.8	NFA31GD1011014	6Vdc	100pF+20%-20%	-	15mA						ReFlow			

△Note • Please read rating and △CAUTION (for storage, operating, rating, soldering, mounting and handling) in this catalog to prevent smoking and/or burning, etc.
 • This catalog has only typical specifications because there is no space for detailed specifications. Therefore, please review our product specifications or consult the approval sheet for product specifications before ordering.

NFE31P Series (1206 Size)



Meet 6A, T-type filter with built-in ferrite bead.

Chip Ferrite Bead

Chip EMIFIL® Universal Type [Power Lines/Signal Lines]

Chip Common Mode Choke Coil

Block Type EMIFIL®

■ Dimensions

■: Electrode
(in mm)

■ Equivalent Circuit

No polarity.

■ Packaging

Code	Packaging	Minimum Quantity
L	180mm Reel Embossed Tape	2000
K	330mm Reel Embossed Tape	8000
B	Bulk(Bag)	500

Refer to pages from p.139 to p.144 for mounting information.

■ Rated Value (□: packaging code)

Part Number	Capacitance	Rated Current	Rated Voltage	Insulation Resistance (min.)	Operating Temperature Range	
NFE31PT220R1E9□	22pF+30%-30%	6A	25Vdc	1000M ohm	-40°C to +85°C	≥3A
NFE31PT470C1E9□	47pF+50%-20%	6A	25Vdc	1000M ohm	-40°C to +85°C	≥3A
NFE31PT101C1E9□	100pF+80%-20%	6A	25Vdc	1000M ohm	-40°C to +85°C	≥3A
NFE31PT221D1E9□	220pF+50%-20%	6A	25Vdc	1000M ohm	-40°C to +85°C	≥3A
NFE31PT471F1E9□	470pF+50%-20%	6A	25Vdc	1000M ohm	-40°C to +85°C	≥3A
NFE31PT152Z1E9□	1500pF+50%-20%	6A	25Vdc	1000M ohm	-40°C to +85°C	Kit ≥3A
NFE31PT222Z1E9□	2200pF+50%-50%	6A	25Vdc	1000M ohm	-40°C to +85°C	Kit ≥3A

Number of Circuit: 1

■ Insertion Loss Characteristics (Main Items)

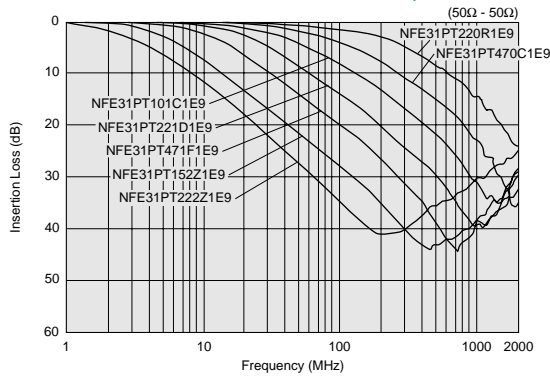

△Note • Please read rating and △CAUTION (for storage, operating, rating, soldering, mounting and handling) in this catalog to prevent smoking and/or burning, etc.
 • This catalog has only typical specifications because there is no space for detailed specifications. Therefore, please review our product specifications or consult the approval sheet for product specifications before ordering.

NFE61P Series (2706 Size)



T-type filter with built-in ferrite bead.

■ Dimensions

(in mm)

□ : Electrode

■ Equivalent Circuit

No polarity.

■ Packaging

Code	Packaging	Minimum Quantity
L	180mm Reel Embossed Tape	2500
K	330mm Reel Embossed Tape	8000
B	Bulk(Bag)	500

Refer to pages from p.139 to p.144 for mounting information.

■ Rated Value (□: packaging code)

Part Number	Capacitance	Rated Current	Rated Voltage	Insulation Resistance (min.)	Operating Temperature Range	
NFE61PT330B1H9□	33pF+30%-30%	2A	50Vdc	1000M ohm	-25°C to +85°C	≥1A
NFE61PT680B1H9□	68pF+30%-30%	2A	50Vdc	1000M ohm	-25°C to +85°C	≥1A
NFE61PT101Z1H9□	100pF+30%-30%	2A	50Vdc	1000M ohm	-25°C to +85°C	≥1A
NFE61PT181B1H9□	180pF+30%-30%	2A	50Vdc	1000M ohm	-25°C to +85°C	≥1A
NFE61PT361B1H9□	360pF+20%-20%	2A	50Vdc	1000M ohm	-25°C to +85°C	≥1A
NFE61PT681B1H9□	680pF+30%-30%	2A	50Vdc	1000M ohm	-25°C to +85°C	≥1A
NFE61PT102E1H9□	1000pF+80%-20%	2A	50Vdc	1000M ohm	-25°C to +85°C	Kit ≥1A
NFE61PT472C1H9□	4700pF+80%-20%	2A	50Vdc	1000M ohm	-25°C to +85°C	Kit ≥1A

Number of Circuit: 1

■ Insertion Loss Characteristics (Main Items)



△Note • Please read rating and △CAUTION (for storage, operating, rating, soldering, mounting and handling) in this catalog to prevent smoking and/or burning, etc.
 • This catalog has only typical specifications because there is no space for detailed specifications. Therefore, please review our product specifications or consult the approval sheet for product specifications before ordering.

NFM18PS Series (0603 Size)



3-terminal capacitor for power lines whose ground impedance has reduced.

*Please refer to the products which are designed for both power lines and signal lines.



■ Dimensions

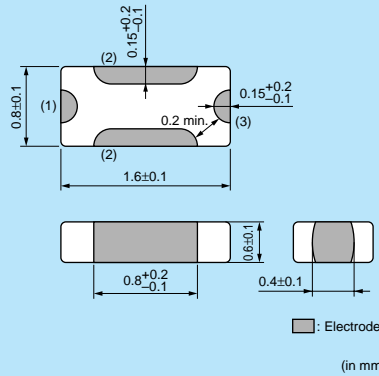

■ Equivalent Circuit

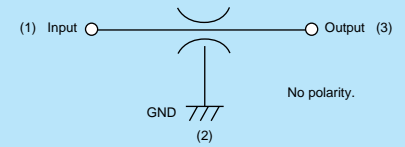

■ Packaging

Code	Packaging	Minimum Quantity
D	180mm Reel Paper Tape	4000
B	Bulk(Bag)	500

Refer to pages from p.139 to p.144 for mounting information.

■ Rated Value (□: packaging code)

Part Number	Capacitance	Rated Current	Rated Voltage	Insulation Resistance (min.)	Operating Temperature Range	
NFM18PS474R0J3□	0.47μF+20%-20%	2A	6.3Vdc	1000M ohm	-55°C to +125°C	Kit $\geq 1A$
NFM18PS105R0J3□	1.0μF+20%-20%	2A	6.3Vdc	500M ohm	-55°C to +105°C	Kit $\geq 1A$

Number of Circuit: 1

■ Insertion Loss Characteristics (Main Items)



△Note • Please read rating and △CAUTION (for storage, operating, rating, soldering, mounting and handling) in this catalog to prevent smoking and/or burning, etc.
 • This catalog has only typical specifications because there is no space for detailed specifications. Therefore, please review our product specifications or consult the approval sheet for product specifications before ordering.

NFM18PC Series (0603 Size)



4A max, 0603 size chip 3-terminal capacitor for power lines.

*Please refer to the products which are designed for both power lines and signal lines.

NFM18PC (0.1 to 0.47μF, 2.2μF-6.3V)

■ Dimensions

(in mm)

■ Equivalent Circuit

No polarity.

■ Packaging

Code	Packaging	Minimum Quantity
D	180mm Reel Paper Tape	4000
B	Bulk(Bag)	500

NFM18PC (1μF, 2.2μF-10V)

■ Dimensions

(in mm)

■ Equivalent Circuit

No polarity.

■ Packaging

Code	Packaging	Minimum Quantity
D	180mm Reel Paper Tape	4000
B	Bulk(Bag)	500

Refer to pages from p.139 to p.144 for mounting information.

■ Rated Value (□: packaging code)

Part Number	Capacitance	Rated Current	Rated Voltage	Insulation Resistance (min.)	Operating Temperature Range	
NFM18PC104R1C3□	0.1μF±20%	2A	16Vdc	1000M ohm	-55°C to +125°C	Kit ≥1A
NFM18PC224R0J3□	0.22μF±20%	2A	6.3Vdc	1000M ohm	-55°C to +125°C	Kit ≥1A
NFM18PC474R0J3□	0.47μF±20%	2A	6.3Vdc	1000M ohm	-55°C to +125°C	Kit ≥1A
NFM18PC105R0J3□	1.0μF±20%	4A	6.3Vdc	500M ohm	-55°C to +105°C	Kit ≥1A
NFM18PC225B0J3□	2.2μF±20%	2A	6.3Vdc	200M ohm	-40°C to +85°C	Kit ≥1A
NFM18PC225B1A3□	2.2μF±20%	4A	10Vdc	200M ohm	-40°C to +85°C	Kit ≥3A

Number of Circuit: 1

■ Insertion Loss Characteristics (Main Items)

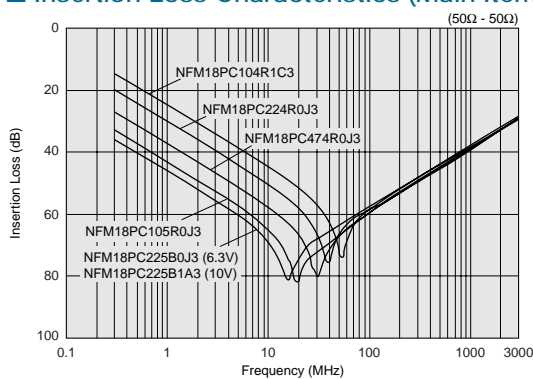

△Note • Please read rating and △CAUTION (for storage, operating, rating, soldering, mounting and handling) in this catalog to prevent smoking and/or burning, etc.
 • This catalog has only typical specifications because there is no space for detailed specifications. Therefore, please review our product specifications or consult the approval sheet for product specifications before ordering.

Chip Ferrite Bead
Power Lines Type Chip EMIFIL®
Chip Common Mode Choke Coil
Block Type EMIFIL®

• High frequency performance of NFM18PS series

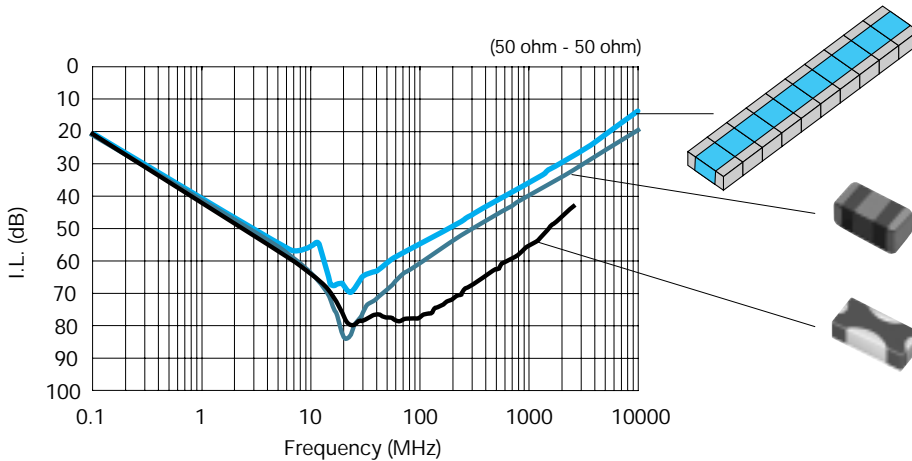

Chip 3 terminal capacitor

2 terminal MLCC: 2012 size
(0.1μF x 10pcs parallel)

NFM18PC105R0J3 1pc
: 1608 size (1.0μF)

NFM18PS105R0J3 1pc
: 1608 size (1.0μF)

NFM18PS series has better high frequency performance compared to normal chip 3 terminal capacitors.

• Optimize of bypass capacitors using chip 3 terminal capacitor

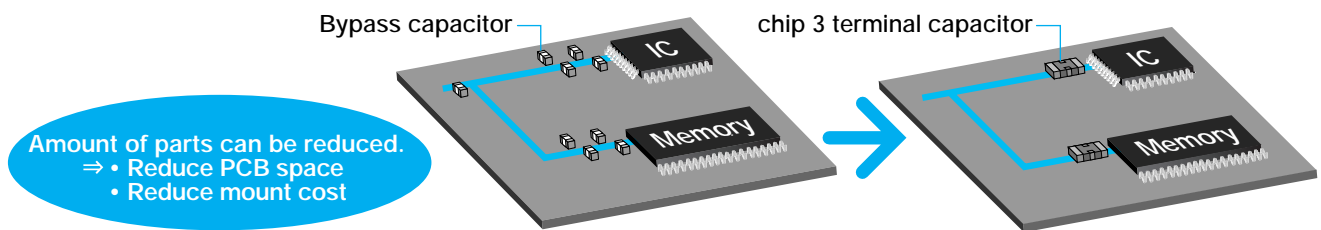

Comparison of performance as bypass capacitor

Without capacitor

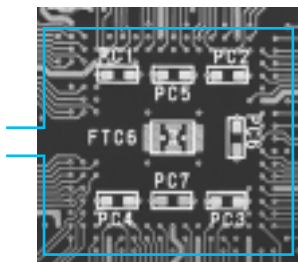

Micro computer

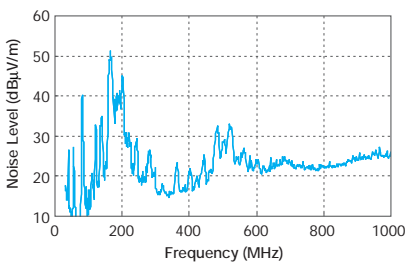
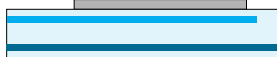

With MLCC 0.22μF x 4

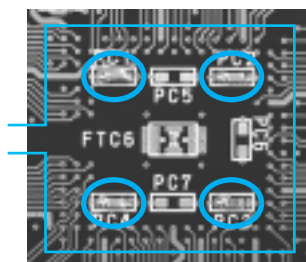

Micro computer

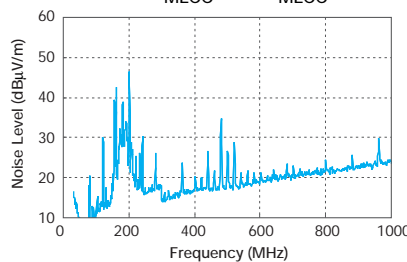
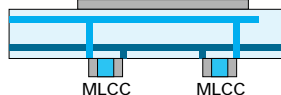

With chip 3 terminal capacitor (NFM) 1μF x 1

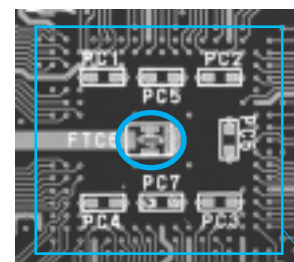

Micro computer

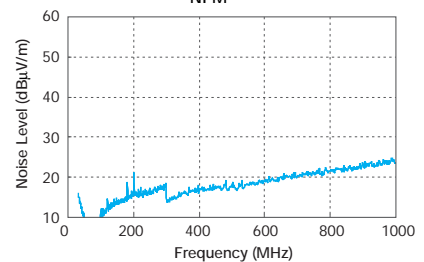
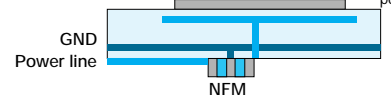

Noise suppression effect of NFM series is better than MLCCs. (1 NFM is better than 4 MLCCs)

△Note • Please read rating and △CAUTION (for storage, operating, rating, soldering, mounting and handling) in this catalog to prevent smoking and/or burning, etc.
• This catalog has only typical specifications because there is no space for detailed specifications. Therefore, please review our product specifications or consult the approval sheet for product specifications before ordering.

NFM21P Series (0805 Size)



6A max, 0805 size chip 3-terminal capacitor for power lines.

*Please refer to the products which are designed for both power lines and signal lines.

■ Dimensions

(in mm)

■ Equivalent Circuit

■ Packaging

Code	Packaging	Minimum Quantity
D	180mm Reel Paper Tape	4000
B	Bulk(Bag)	500

Refer to pages from p.139 to p.144 for mounting information.

■ Rated Value (□: packaging code)

Part Number	Capacitance	Rated Current	Rated Voltage	Insulation Resistance (min.)	Operating Temperature Range	
NFM21PC104R1E3□	0.1μF+20%-20%	2A	25Vdc	1000M ohm	-55°C to +125°C	Kit ≥1A
NFM21PC224R1C3□	0.22μF+20%-20%	2A	16Vdc	1000M ohm	-55°C to +125°C	Kit ≥1A
NFM21PC474R1C3□	0.47μF+20%-20%	2A	16Vdc	1000M ohm	-55°C to +125°C	Kit ≥1A
NFM21PC105B1A3□	1.0μF+20%-20%	4A	10Vdc	500M ohm	-40°C to +85°C	Kit ≥3A
NFM21PC105B1C3□	1.0μF+20%-20%	4A	16Vdc	500M ohm	-40°C to +85°C	Kit ≥3A
NFM21PC225B0J3□	2.2μF+20%-20%	4A	6.3Vdc	200M ohm	-40°C to +85°C	Kit ≥3A
NFM21PC475B1A3□	4.7μF+20%-20%	6A	10Vdc	100M ohm	-40°C to +85°C	Kit ≥3A

Number of Circuit: 1

■ Insertion Loss Characteristics (Main Items)

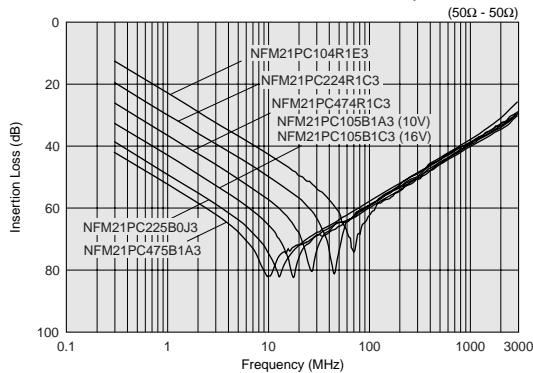

△Note • Please read rating and △CAUTION (for storage, operating, rating, soldering, mounting and handling) in this catalog to prevent smoking and/or burning, etc.
 • This catalog has only typical specifications because there is no space for detailed specifications. Therefore, please review our product specifications or consult the approval sheet for product specifications before ordering.

Chip Ferrite Bead
Power Lines Type Chip EMIFIL®
Chip Common Mode Choke Coil
Block Type EMIFIL®

NFM3DP Series (1205 Size)



1205 size 3-terminal capacitor for power lines.

*Please refer to the products which are designed for both power lines and signal lines.

■ Dimensions

(in mm)

■ Equivalent Circuit

No polarity.

■ Packaging

Code	Packaging	Minimum Quantity
L	180mm Reel Embossed Tape	4000
B	Bulk(Bag)	500

Refer to pages from p.139 to p.144 for mounting information.

■ Rated Value (□: packaging code)

Part Number	Capacitance	Rated Current	Rated Voltage	Insulation Resistance (min.)	Operating Temperature Range	
NFM3DPC223R1H3□	0.022μF+20%-20%	2A	50Vdc	1000M ohm	-55°C to +125°C	≥1A

Number of Circuit: 1

■ Insertion Loss Characteristics (Main Items)

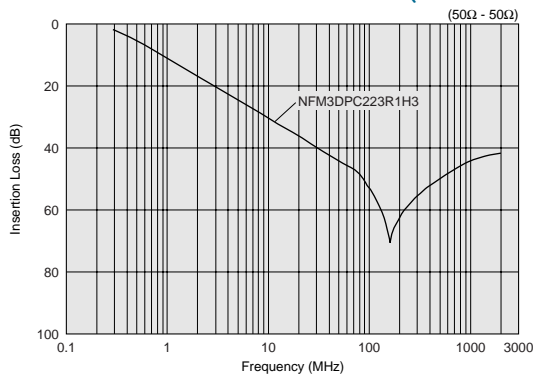

■ Notice (Rating)

When NFM3DP series is used in operating temperatures exceeding +85°C, derating of current is necessary. Please apply the derating curve shown in chart according to the operating temperature.

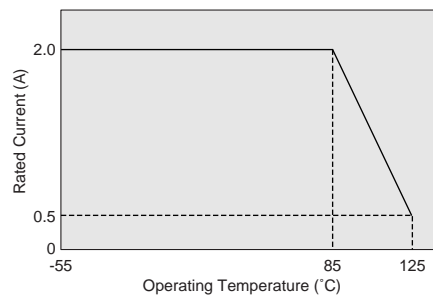

△Note • Please read rating and △CAUTION (for storage, operating, rating, soldering, mounting and handling) in this catalog to prevent smoking and/or burning, etc.
 • This catalog has only typical specifications because there is no space for detailed specifications. Therefore, please review our product specifications or consult the approval sheet for product specifications before ordering.

Chip Ferrite Bead
Chip EMIFIL® Power Lines Type
Chip Common Mode Choke Coil
Block Type EMIFIL®

NFM31P Series (1206 Size)



6A/27microF, 1206 size chip 3-terminal capacitor for power lines.

*Please refer to the products which are designed for both power lines and signal lines.

■ Dimensions

(in mm)

■ Equivalent Circuit

No polarity.

■ Packaging

Code	Packaging	Minimum Quantity
L	180mm Reel Embossed Tape	3000
B	Bulk(Bag)	500

Refer to pages from p.139 to p.144 for mounting information.

■ Rated Value (□: packaging code)

Part Number	Capacitance	Rated Current	Rated Voltage	Insulation Resistance (min.)	Operating Temperature Range	
NFM31PC276B0J3□	27μF+20%-20%	6A	6.3Vdc	20M ohm	-40°C to +85°C	Kit $\geq 3A$

Number of Circuit: 1

■ Insertion Loss Characteristics (Main Items)

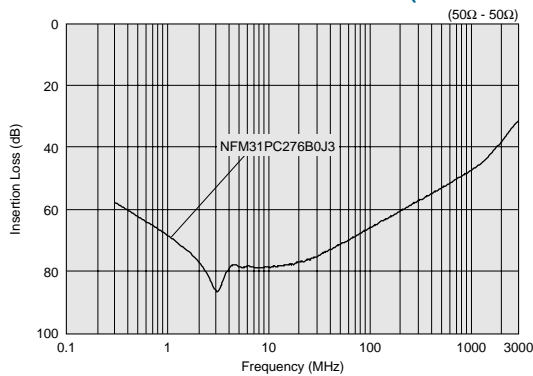

△Note • Please read rating and △CAUTION (for storage, operating, rating, soldering, mounting and handling) in this catalog to prevent smoking and/or burning, etc.
 • This catalog has only typical specifications because there is no space for detailed specifications. Therefore, please review our product specifications or consult the approval sheet for product specifications before ordering.

NFM41P Series (1806 Size)



6A max, 1806 size chip 3-terminal capacitor for power lines.

*Please refer to the products which are designed for both power lines and signal lines.



■ Dimensions

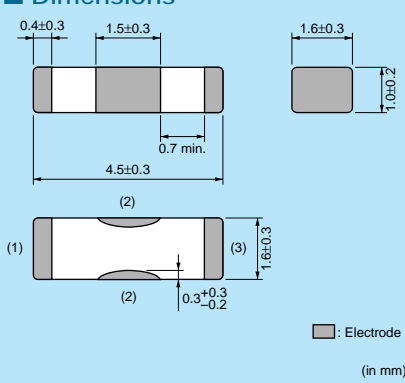

(in mm)

■ Equivalent Circuit

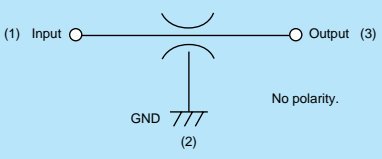

No polarity.

■ Packaging

Code	Packaging	Minimum Quantity
L	180mm Reel Embossed Tape	4000
B	Bulk(Bag)	500

Refer to pages from p.139 to p.144 for mounting information.

■ Rated Value (□: packaging code)

Part Number	Capacitance	Rated Current	Rated Voltage	Insulation Resistance (min.)	Operating Temperature Range	
NFM41PC204F1H3□	0.2μF+80%-20%	2A	50Vdc	1000M ohm	-55°C to +85°C	Kit ≥1A
NFM41PC155B1E3□	1.5μF+20%-20%	6A	25Vdc	300M ohm	-55°C to +85°C	Kit ≥3A

Number of Circuit: 1

■ Insertion Loss Characteristics (Main Items)

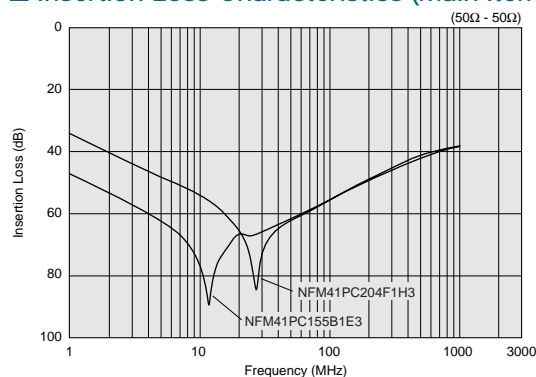

△Note • Please read rating and △CAUTION (for storage, operating, rating, soldering, mounting and handling) in this catalog to prevent smoking and/or burning, etc.
 • This catalog has only typical specifications because there is no space for detailed specifications. Therefore, please review our product specifications or consult the approval sheet for product specifications before ordering.

NFM55P Series (2220 Size)



50V/6A/1.5microF, large capacitance chip 3-terminal capacitor.

*Please refer to the products which are designed for both power lines and signal lines.

■ Dimensions

■ Electrode (in mm)

■ Equivalent Circuit

No polarity.

■ Packaging

Code	Packaging	Minimum Quantity
L	180mm Reel Embossed Tape	500
B	Bulk(Bag)	100

Refer to pages from p.139 to p.144 for mounting information.

■ Rated Value (□: packaging code)

Part Number	Capacitance	Rated Current	Rated Voltage	Insulation Resistance (min.)	Operating Temperature Range	
NFM55PC155F1H4□	1.5μF+80%-20%	6A	50Vdc	100M ohm	-55°C to +85°C	≥3A

Number of Circuit: 1

■ Insertion Loss Characteristics (Main Items)

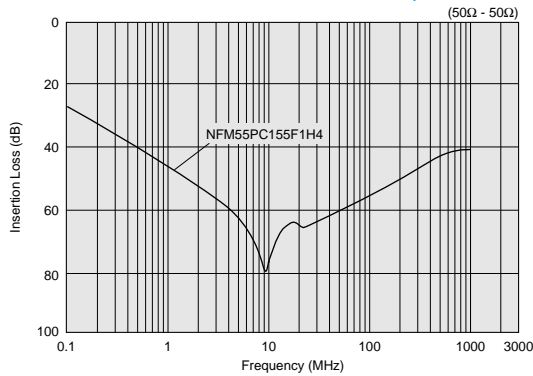

△Note • Please read rating and △CAUTION (for storage, operating, rating, soldering, mounting and handling) in this catalog to prevent smoking and/or burning, etc.
 • This catalog has only typical specifications because there is no space for detailed specifications. Therefore, please review our product specifications or consult the approval sheet for product specifications before ordering.

NFM18C Series (0603 Size)



0603 size general 3-terminal capacitor.



■ Dimensions

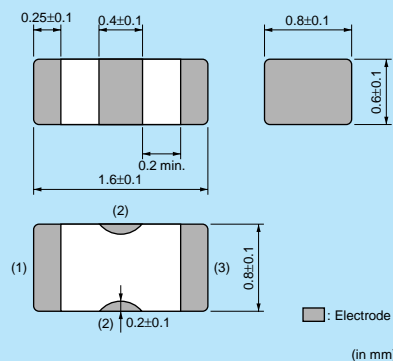

■ Equivalent Circuit

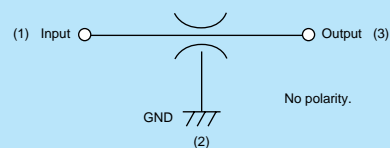

■ Packaging

Code	Packaging	Minimum Quantity
D	180mm Reel Paper Tape	4000
B	Bulk(Bag)	500

Refer to pages from p.139 to p.144 for mounting information.

■ Rated Value (□: packaging code)

Part Number	Capacitance	Rated Current	Rated Voltage	Insulation Resistance (min.)	Operating Temperature Range	
NFM18CC220U1C3□	22pF+20%-20%	400mA	16Vdc	1000M ohm	-55°C to +125°C	Kit
NFM18CC470U1C3□	47pF+20%-20%	400mA	16Vdc	1000M ohm	-55°C to +125°C	Kit
NFM18CC101R1C3□	100pF+20%-20%	500mA	16Vdc	1000M ohm	-55°C to +125°C	Kit
NFM18CC221R1C3□	220pF+20%-20%	500mA	16Vdc	1000M ohm	-55°C to +125°C	Kit
NFM18CC471R1C3□	470pF+20%-20%	500mA	16Vdc	1000M ohm	-55°C to +125°C	Kit
NFM18CC102R1C3□	1000pF+20%-20%	600mA	16Vdc	1000M ohm	-55°C to +125°C	Kit
NFM18CC222R1C3□	2200pF+20%-20%	700mA	16Vdc	1000M ohm	-55°C to +125°C	Kit
NFM18CC223R1C3□	22000pF+20%-20%	1000mA	16Vdc	1000M ohm	-55°C to +125°C	Kit $\geq 1A$

Number of Circuit: 1

■ Insertion Loss Characteristics (Main Items)

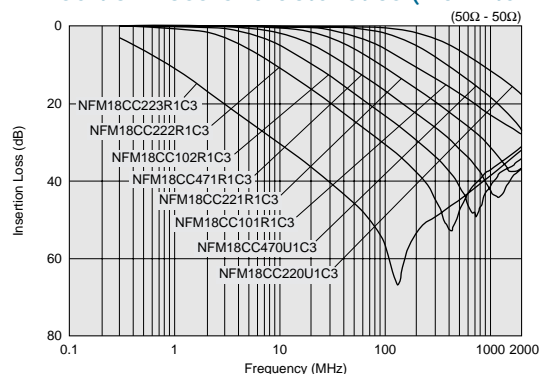

△Note • Please read rating and △CAUTION (for storage, operating, rating, soldering, mounting and handling) in this catalog to prevent smoking and/or burning, etc.
 • This catalog has only typical specifications because there is no space for detailed specifications. Therefore, please review our product specifications or consult the approval sheet for product specifications before ordering.

Chip Ferrite Bead

Chip EMIFIL®
Signal Lines Type

Chip Common Mode Choke Coil

Block Type EMIFIL®

NFM21C Series (0805 Size)



0805 size general 3-terminal capacitor.

■ Dimensions

0.3±0.2
0.6±0.2
2.0±0.2
0.85±0.1
1.25±0.1
0.2±0.2
0.1±0.1

Legend: Electrode (in mm)

■ Equivalent Circuit

(1) Input ———— Output (3)
GND (2)
No polarity.

■ Packaging

Code	Packaging	Minimum Quantity
D	180mm Reel Paper Tape	4000
B	Bulk(Bag)	500

Refer to pages from p.139 to p.144 for mounting information.

■ Rated Value (□: packaging code)

Part Number	Capacitance	Rated Current	Rated Voltage	Insulation Resistance (min.)	Operating Temperature Range	
NFM21CC220U1H3□	22pF+20%-20%	700mA	50Vdc	1000M ohm	-55°C to +125°C	Kit
NFM21CC470U1H3□	47pF+20%-20%	700mA	50Vdc	1000M ohm	-55°C to +125°C	Kit
NFM21CC101U1H3□	100pF+20%-20%	700mA	50Vdc	1000M ohm	-55°C to +125°C	Kit
NFM21CC221R1H3□	220pF+20%-20%	700mA	50Vdc	1000M ohm	-55°C to +125°C	Kit
NFM21CC471R1H3□	470pF+20%-20%	1000mA	50Vdc	1000M ohm	-55°C to +125°C	Kit ≥1A
NFM21CC102R1H3□	1000pF+20%-20%	1000mA	50Vdc	1000M ohm	-55°C to +125°C	Kit ≥1A
NFM21CC222R1H3□	2200pF+20%-20%	1000mA	50Vdc	1000M ohm	-55°C to +125°C	Kit ≥1A
NFM21CC223R1H3□	22000pF+20%-20%	2000mA	50Vdc	1000M ohm	-55°C to +125°C	Kit ≥1A

Number of Circuit: 1

■ Insertion Loss Characteristics (Main Items)

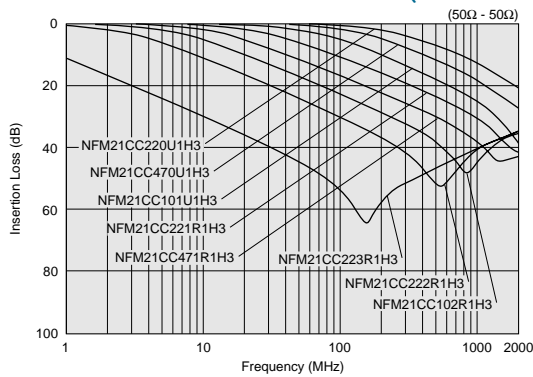

△Note • Please read rating and △CAUTION (for storage, operating, rating, soldering, mounting and handling) in this catalog to prevent smoking and/or burning, etc.
• This catalog has only typical specifications because there is no space for detailed specifications. Therefore, please review our product specifications or consult the approval sheet for product specifications before ordering.

NFM3DC Series (1205 Size)



1205 size general 3-terminal capacitor.



■ Dimensions

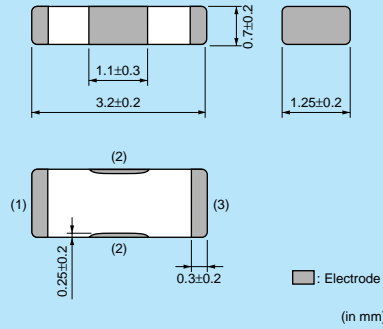

■ Equivalent Circuit

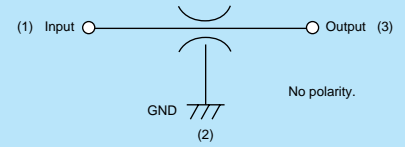

■ Packaging

Code	Packaging	Minimum Quantity
L	180mm Reel Embossed Tape	4000
B	Bulk(Bag)	500

Refer to pages from p.139 to p.144 for mounting information.

■ Rated Value (□: packaging code)

Part Number	Capacitance	Rated Current	Rated Voltage	Insulation Resistance (min.)	Operating Temperature Range
NFM3DCC220U1H3□	22pF+50%-20%	300mA	50Vdc	1000M ohm	-55°C to +125°C
NFM3DCC470U1H3□	47pF+50%-20%	300mA	50Vdc	1000M ohm	-55°C to +125°C
NFM3DCC101U1H3□	100pF+50%-20%	300mA	50Vdc	1000M ohm	-55°C to +125°C
NFM3DCC221R1H3□	220pF+50%-20%	300mA	50Vdc	1000M ohm	-55°C to +125°C
NFM3DCC471R1H3□	470pF+50%-20%	300mA	50Vdc	1000M ohm	-55°C to +125°C
NFM3DCC102R1H3□	1000pF+50%-20%	300mA	50Vdc	1000M ohm	-55°C to +125°C
NFM3DCC222R1H3□	2200pF+50%-20%	300mA	50Vdc	1000M ohm	-55°C to +125°C
NFM3DCC223R1H3□	22000pF+50%-20%	300mA	50Vdc	1000M ohm	-55°C to +125°C

Number of Circuit: 1

■ Insertion Loss Characteristics (Main Items)

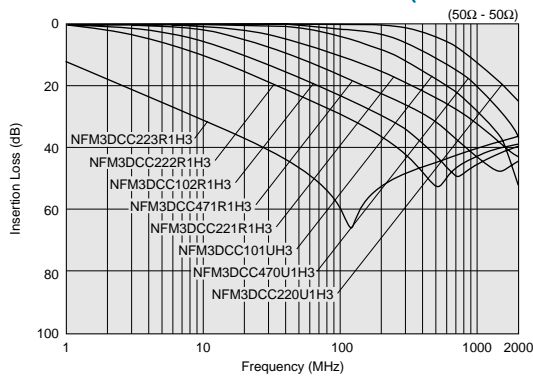

△Note • Please read rating and △CAUTION (for storage, operating, rating, soldering, mounting and handling) in this catalog to prevent smoking and/or burning, etc.
 • This catalog has only typical specifications because there is no space for detailed specifications. Therefore, please review our product specifications or consult the approval sheet for product specifications before ordering.

NFM41C Series (1806 Size)



1806 size general 3-terminal capacitor.

■ Dimensions

(in mm)

■ Equivalent Circuit

No polarity.

■ Packaging

Code	Packaging	Minimum Quantity
L	180mm Reel Embossed Tape	4000
B	Bulk(Bag)	500

Refer to pages from p.139 to p.144 for mounting information.

■ Rated Value (□: packaging code)

Part Number	Capacitance	Rated Current	Rated Voltage	Insulation Resistance (min.)	Operating Temperature Range
NFM41CC220U2A3□	22pF+50%-20%	300mA	100Vdc	10000M ohm	-55°C to +125°C
NFM41CC470U2A3□	47pF+50%-20%	300mA	100Vdc	10000M ohm	-55°C to +125°C
NFM41CC101U2A3□	100pF+50%-20%	300mA	100Vdc	10000M ohm	-55°C to +125°C
NFM41CC221U2A3□	220pF+50%-20%	300mA	100Vdc	10000M ohm	-55°C to +125°C
NFM41CC471R2A3□	470pF+50%-20%	300mA	100Vdc	10000M ohm	-55°C to +125°C
NFM41CC102R2A3□	1000pF+50%-20%	300mA	100Vdc	10000M ohm	-55°C to +125°C
NFM41CC222R2A3□	2200pF+50%-20%	300mA	100Vdc	10000M ohm	-55°C to +125°C
NFM41CC223R2A3□	22000pF+50%-20%	300mA	100Vdc	10000M ohm	-55°C to +125°C

Number of Circuit: 1

■ Insertion Loss Characteristics (Main Items)

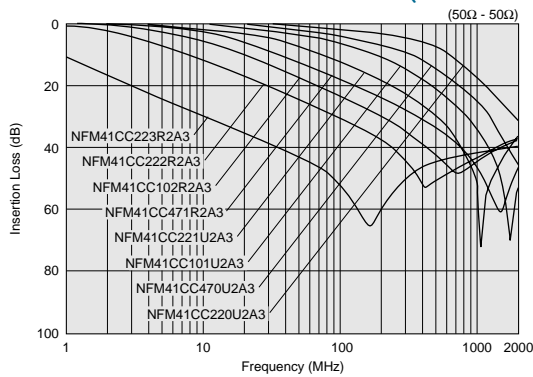

△Note • Please read rating and △CAUTION (for storage, operating, rating, soldering, mounting and handling) in this catalog to prevent smoking and/or burning, etc.
 • This catalog has only typical specifications because there is no space for detailed specifications. Therefore, please review our product specifications or consult the approval sheet for product specifications before ordering.

NFA31C Series (1206 Size)



4-lines chip 3-terminal capacitor array, 1206 size.

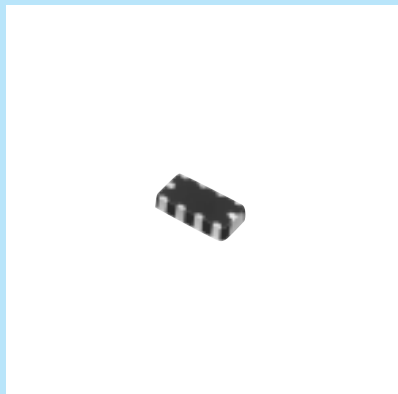

■ Dimensions

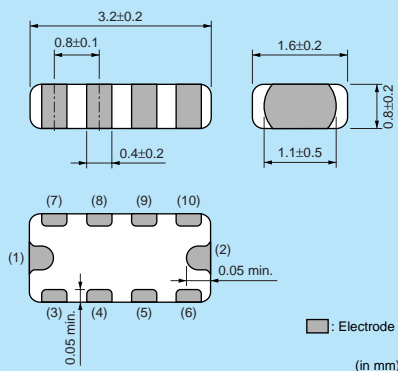

■ Equivalent Circuit

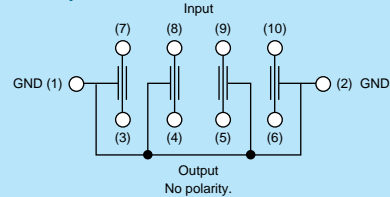

■ Packaging

Code	Packaging	Minimum Quantity
D	180mm Reel Paper Tape	4000
B	Bulk(Bag)	100

Refer to pages from p.139 to p.144 for mounting information.

■ Rated Value (□: packaging code)

Part Number	Capacitance	Rated Current	Rated Voltage	Insulation Resistance (min.)	Operating Temperature Range	
NFA31CC220S1E4□	22pF+20%-20%	200mA	25Vdc	1000M ohm	-40°C to +85°C	Kit
NFA31CC470S1E4□	47pF+20%-20%	200mA	25Vdc	1000M ohm	-40°C to +85°C	Kit
NFA31CC101S1E4□	100pF+20%-20%	200mA	25Vdc	1000M ohm	-40°C to +85°C	Kit
NFA31CC221S1E4□	220pF+20%-20%	200mA	25Vdc	1000M ohm	-40°C to +85°C	Kit
NFA31CC471R1E4□	470pF+20%-20%	200mA	25Vdc	1000M ohm	-40°C to +85°C	Kit
NFA31CC102R1E4□	1000pF+20%-20%	200mA	25Vdc	1000M ohm	-40°C to +85°C	Kit
NFA31CC222R1E4□	2200pF+20%-20%	200mA	25Vdc	1000M ohm	-40°C to +85°C	Kit
NFA31CC223R1C4□	22000pF+20%-20%	200mA	16Vdc	1000M ohm	-40°C to +85°C	Kit

Number of Circuit: 4

■ Insertion Loss Characteristics (Main Items)

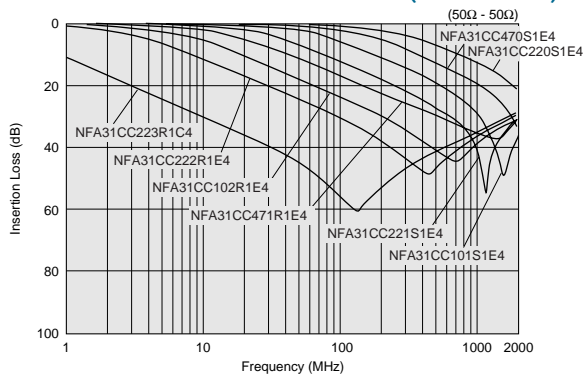

△Note • Please read rating and △CAUTION (for storage, operating, rating, soldering, mounting and handling) in this catalog to prevent smoking and/or burning, etc.
 • This catalog has only typical specifications because there is no space for detailed specifications. Therefore, please review our product specifications or consult the approval sheet for product specifications before ordering.

NFL18ST Series (0603 Size)



T-type LC filter. Reduce waveform distortion of high speed signal.

NFL18ST_H

■ Dimensions

(Top View) 1.6 ± 0.1

(Side View) 0.2 ± 0.1 , 0.3 ± 0.1 , 0.2 ± 0.1 , 0.8 ± 0.1

(Bottom View) 0.2 min., 0.15 ± 0.1

Legend: Electrode (in mm)

■ Equivalent Circuit

Input (1) — Inductor — Capacitor — Inductor — Output (3)

Capacitor connected to GND (2)

No Polarity.

■ Packaging

Code	Packaging	Minimum Quantity
D	180mm Reel Paper Tape	4000
B	Bulk(Bag)	1000

NFL18ST_X

■ Dimensions

(Top View) 0.2 min., 0.2 min., 0.25 ± 0.1 , 0.4 ± 0.1 , 1.6 ± 0.1

(Side View) 0.8 ± 0.1

Legend: Electrode (in mm)

■ Equivalent Circuit

Input (1) — Inductor — Capacitor — Inductor — Output (3)

Capacitor connected to GND (2)

No Polarity.

■ Packaging

Code	Packaging	Minimum Quantity
D	180mm Reel Paper Tape	4000
B	Bulk(Bag)	1000

Refer to pages from p.139 to p.144 for mounting information.

■ Rated Value (□: packaging code)

Part Number	Nominal Cut-off Frequency	Capacitance	Inductance	Insertion Loss (Cut-off Frequency)	Insertion Loss (200MHz) (min.)	Insertion Loss (300MHz) (min.)	Insertion Loss (400MHz) (min.)	Rated Current	Rated Voltage	
NFL18ST506H1A3□	50MHz	110pF (Typ.)	350nH (Typ.)	6dB max.	30dB	30dB	30dB	75mA	10Vdc	New Kit QTV
NFL18ST706H1A3□	70MHz	70pF (Typ.)	230nH (Typ.)	6dB max.	-	30dB	30dB	75mA	10Vdc	New Kit QTV
NFL18ST107H1A3□	100MHz	50pF (Typ.)	150nH (Typ.)	6dB max.	-	-	30dB	75mA	10Vdc	New Kit QTV

Insulation Resistance (min.): 1000M ohm Withstand Voltage: 30Vdc Operating Temperature Range: -55°C to +125°C Number of Circuits: 1

■ Insertion Loss Characteristics (Main Items)

NFL18ST_H Series

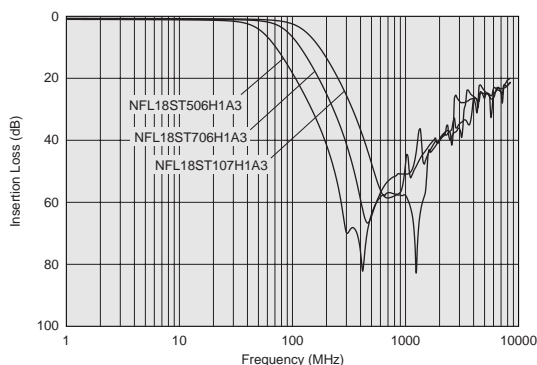

Continued on the following page.

△Note • Please read rating and **△CAUTION** (for storage, operating, rating, soldering, mounting and handling) in this catalog to prevent smoking and/or burning, etc.
 • This catalog has only typical specifications because there is no space for detailed specifications. Therefore, please review our product specifications or consult the approval sheet for product specifications before ordering.

■ Rated Value (□: packaging code)

Part Number	Nominal Cut-off Frequency	Capacitance	Inductance	Rated Current	Rated Voltage	Insulation Resistance (min.)	Withstand Voltage	Operating Temperature Range	
NFL18ST207X1C3□	200MHz	25pF±20%	110nH±20%	150mA	16Vdc	1000M ohm	50Vdc	-55°C to +125°C	Kit
NFL18ST307X1C3□	300MHz	18pF±20%	62nH±20%	200mA	16Vdc	1000M ohm	50Vdc	-55°C to +125°C	Kit
NFL18ST507X1C3□	500MHz	10pF±20%	43nH±20%	200mA	16Vdc	1000M ohm	50Vdc	-55°C to +125°C	Kit

Number of Circuits: 1

■ Insertion Loss Characteristics (Main Items)

NFL18ST_X Series

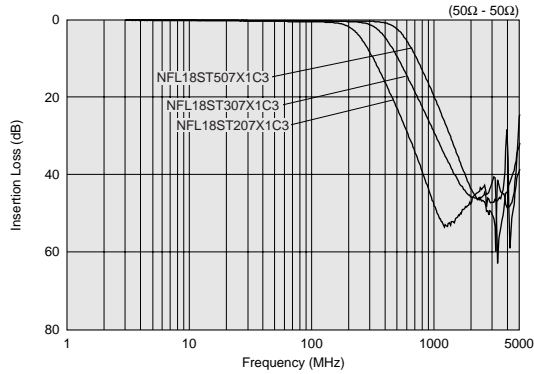

△Note • Please read rating and △CAUTION (for storage, operating, rating, soldering, mounting and handling) in this catalog to prevent smoking and/or burning, etc.
• This catalog has only typical specifications because there is no space for detailed specifications. Therefore, please review our product specifications or consult the approval sheet for product specifications before ordering.

NFL18SP Series (0603 Size)



PI-type LC filter. Reduce waveform distortion of high speed signal.

■ Dimensions

■ Electrode (in mm)

■ Equivalent Circuit

No polarity.

■ Packaging

Code	Packaging	Minimum Quantity
D	180mm Reel Paper Tape	4000
B	Bulk(Bag)	1000

Refer to pages from p.139 to p.144 for mounting information.

■ Rated Value (□: packaging code)

Part Number	Nominal Cut-off Frequency	Capacitance	Inductance	Rated Current	Rated Voltage	Insulation Resistance (min.)	Withstand Voltage	Operating Temperature Range	
NFL18SP157X1A3□	150MHz	34pF±20%	100nH±20%	100mA	10Vdc	1000M ohm	30Vdc	-55°C to +125°C	Kit
NFL18SP207X1A3□	200MHz	24pF±20%	80nH±20%	100mA	10Vdc	1000M ohm	30Vdc	-55°C to +125°C	Kit
NFL18SP307X1A3□	300MHz	19pF±20%	60nH±20%	100mA	10Vdc	1000M ohm	30Vdc	-55°C to +125°C	Kit
NFL18SP507X1A3□	500MHz	11pF±20%	38nH±20%	100mA	10Vdc	1000M ohm	30Vdc	-55°C to +125°C	Kit

Number of Circuits: 1

■ Insertion Loss Characteristics (Main Items)

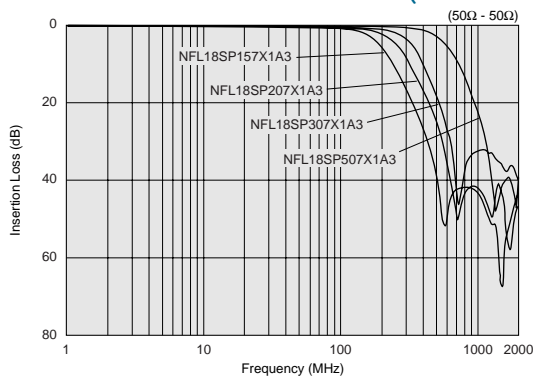

⚠Note • Please read rating and ⚠CAUTION (for storage, operating, rating, soldering, mounting and handling) in this catalog to prevent smoking and/or burning, etc.
 • This catalog has only typical specifications because there is no space for detailed specifications. Therefore, please review our product specifications or consult the approval sheet for product specifications before ordering.

NFL21SP Series (0805 Size)



PI-type LC filter. Reduce waveform distortion of high speed signal.

■ Dimensions

0.3±0.2 0.4±0.2
0.85±0.1
0.6±0.2
2.0±0.2
0.25±0.2
1.25±0.1

Legend: Electrode (in mm)

■ Equivalent Circuit

(1) Input Output (3)
GND (2)
No polarity.

■ Packaging

Code	Packaging	Minimum Quantity
D	180mm Reel Paper Tape	4000
B	Bulk(Bag)	1000

Refer to pages from p.139 to p.144 for mounting information.

■ Rated Value (□: packaging code)

Part Number	Nominal Cut-off Frequency	Capacitance	Inductance	Rated Current	Rated Voltage	Insulation Resistance (min.)	Withstand Voltage	Operating Temperature Range	
NFL21SP106X1C3□	10MHz	670pF±20%	680nH±20%	100mA	16Vdc	1000M ohm	50Vdc	-55°C to +125°C	Kit
NFL21SP206X1C7□	20MHz	240pF±20%	700nH±20%	100mA	16Vdc	1000M ohm	50Vdc	-55°C to +125°C	Kit
NFL21SP506X1C3□	50MHz	84pF±20%	305nH±20%	150mA	16Vdc	1000M ohm	50Vdc	-55°C to +125°C	Kit
NFL21SP706X1C3□	70MHz	76pF±20%	185nH±20%	150mA	16Vdc	1000M ohm	50Vdc	-55°C to +125°C	Kit
NFL21SP107X1C3□	100MHz	44pF±20%	135nH±20%	200mA	16Vdc	1000M ohm	50Vdc	-55°C to +125°C	Kit
NFL21SP157X1C3□	150MHz	28pF±20%	128nH±20%	200mA	16Vdc	1000M ohm	50Vdc	-55°C to +125°C	Kit
NFL21SP207X1C3□	200MHz	22pF±20%	72nH±20%	250mA	16Vdc	1000M ohm	50Vdc	-55°C to +125°C	Kit
NFL21SP307X1C3□	300MHz	19pF±10%	45nH±10%	300mA	16Vdc	1000M ohm	50Vdc	-55°C to +125°C	Kit
NFL21SP407X1C3□	400MHz	16pF±10%	34nH±10%	300mA	16Vdc	1000M ohm	50Vdc	-55°C to +125°C	Kit
NFL21SP507X1C3□	500MHz	12pF±10%	31nH±10%	300mA	16Vdc	1000M ohm	50Vdc	-55°C to +125°C	Kit

Number of Circuits: 1

■ Insertion Loss Characteristics (Main Items)

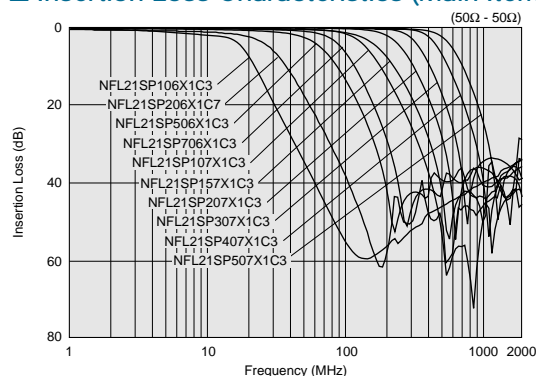

△Note • Please read rating and △CAUTION (for storage, operating, rating, soldering, mounting and handling) in this catalog to prevent smoking and/or burning, etc.
 • This catalog has only typical specifications because there is no space for detailed specifications. Therefore, please review our product specifications or consult the approval sheet for product specifications before ordering.

NFA18SL Series (0603 Size)



LC filter 4-lines array for mobile phones.

NFA18SL 137/187/207/357 V1A45
NFA18SL506X1A45



■ Dimensions

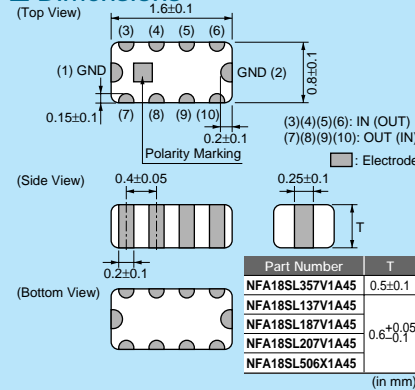

■ Equivalent Circuit

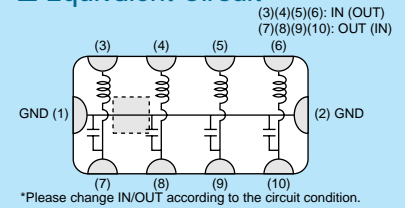

■ Packaging

Code	Packaging	Minimum Quantity
L	180mm Reel Embossed Tape	4000
B	Bulk(Bag)	1000

NFA18SL227V1A45



■ Dimensions

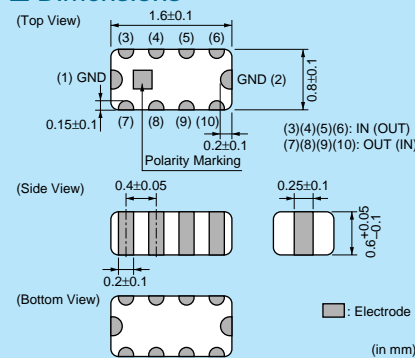

■ Equivalent Circuit

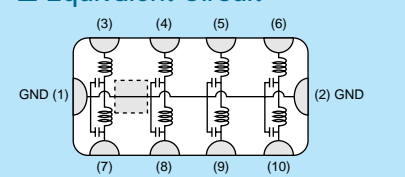

■ Packaging

Code	Packaging	Minimum Quantity
L	180mm Reel Embossed Tape	4000
B	Bulk(Bag)	1000

NFA18SL 307/407/487 V1A45



■ Dimensions

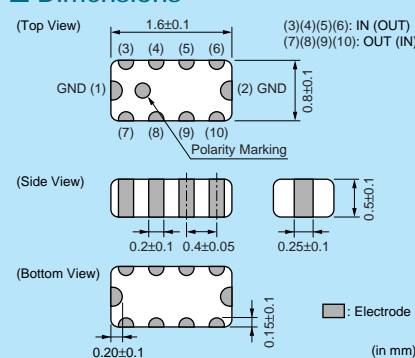

■ Equivalent Circuit

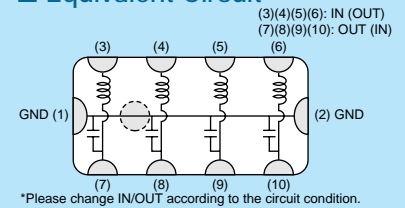

■ Packaging

Code	Packaging	Minimum Quantity
L	180mm Reel Embossed Tape	4000
B	Bulk(Bag)	1000

Refer to pages from p.139 to p.144 for mounting information.

■ Rated Value (□: packaging code)

Part Number	Nominal Cut-off Frequency	Insertion Loss (Cut-off Frequency)	Insertion Loss (470MHz) (min.)	Insertion Loss (800MHz) (min.)	Insertion Loss (900MHz) (min.)	Insertion Loss (2000MHz) (min.)	Rated Current	Rated Voltage	Insulation Resistance (min.)	Withstand Voltage	Kit	OTV
NFA18SL137V1A45□	130MHz	6dBmax	25dB	-	25dB	-	50mA	10Vdc	1000M ohm	30Vdc	Kit	OTV
NFA18SL187V1A45□	180MHz	6dBmax	20dB	-	20dB	-	50mA	10Vdc	1000M ohm	30Vdc	Kit	OTV
NFA18SL207V1A45□	200MHz	6dBmax	15dB	-	15dB	-	50mA	10Vdc	1000M ohm	30Vdc	Kit	OTV
NFA18SL227V1A45□	220MHz	6dBmax	-	-	30dB	30dB	25mA	10Vdc	1000M ohm	30Vdc	Kit	OTV
NFA18SL307V1A45□	300MHz	6dBmax	-	20dB	20dB	-	100mA	10Vdc	1000M ohm	30Vdc	Kit	
NFA18SL357V1A45□	350MHz	6dBmax	-	-	15dB	13dB	35mA	10Vdc	1000M ohm	30Vdc	New Kit	
NFA18SL407V1A45□	400MHz	6dBmax	-	18dB	18dB	-	100mA	10Vdc	1000M ohm	30Vdc	Kit	
NFA18SL487V1A45□	480MHz	6dBmax	-	15dB	15dB	-	100mA	10Vdc	1000M ohm	30Vdc	Kit	

Operating Temperature Range: -40°C to +85°C (NFA18SL 137/187/207/227/357 V1A45), -55°C to +125°C (NFA18SL 307/407/487 V1A45) Number of Circuits: 4 Continued on the following page. □

△Note • Please read rating and △CAUTION (for storage, operating, rating, soldering, mounting and handling) in this catalog to prevent smoking and/or burning, etc.
• This catalog has only typical specifications because there is no space for detailed specifications. Therefore, please review our product specifications or consult the approval sheet for product specifications before ordering.

■ Insertion Loss Characteristics (Main Items)

NFA18SL 137/187/207 V1A45

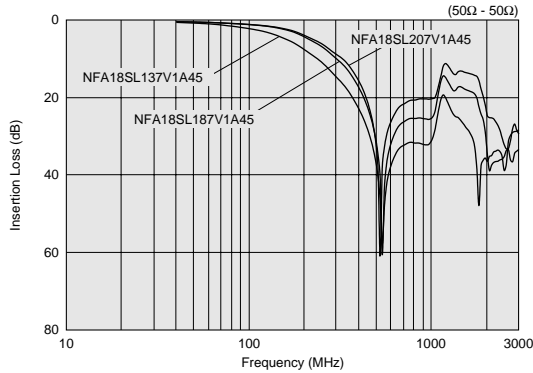

NFA18SL227V1A45

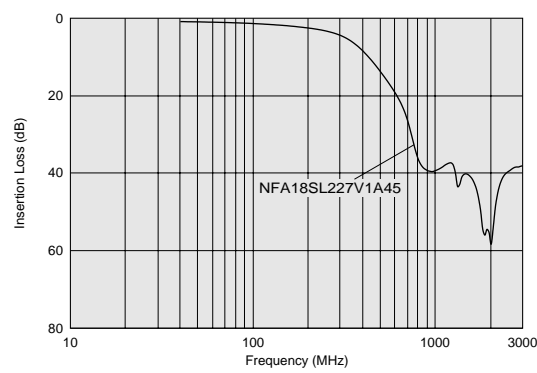

NFA18SL 307/407/487 V1A45

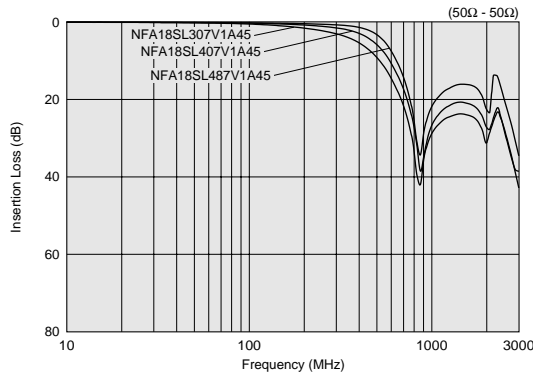

NFA18SL357V1A45

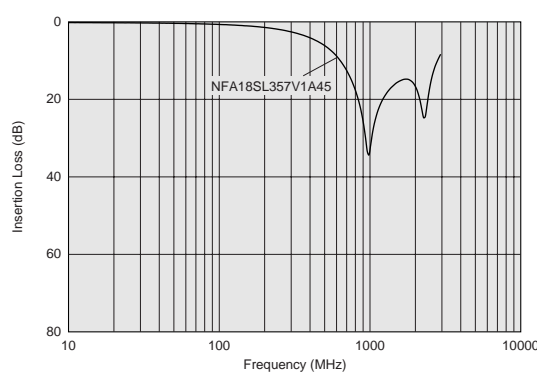

■ Rated Value (□: packaging code)

Part Number	Nominal Cut-off Frequency	Insertion Loss (Cut-off Frequency)	Insertion Loss at 500MHz (min.)	Insertion Loss at 1000MHz (min.)	Rated Voltage	Rated Current	Insulation Resistance (min.)	Withstand Voltage	
NFA18SL506X1A45□	50MHz	6dBmax	30dB	25dB	10Vdc	25mA	1000M ohm	30Vdc	Kit

Operating Temperature Range: -40°C to +85°C Number of Circuits: 4

■ Insertion Loss Characteristics (Main Items)

NFA18SL_X

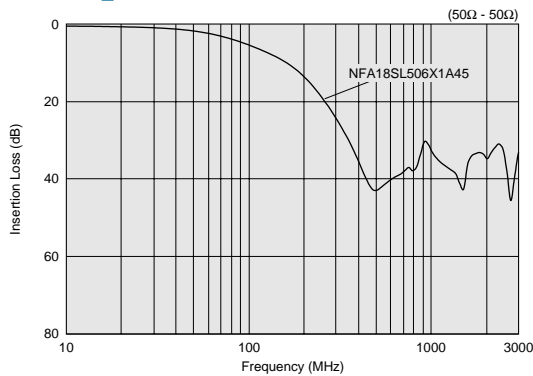

△Note • Please read rating and △CAUTION (for storage, operating, rating, soldering, mounting and handling) in this catalog to prevent smoking and/or burning, etc.
• This catalog has only typical specifications because there is no space for detailed specifications. Therefore, please review our product specifications or consult the approval sheet for product specifications before ordering.

NFA18SD Series (0603 Size)



For differential signal I/F of LCD or camera in mobile phones.

■ Dimensions

(Top View) 1.6±0.1, 0.8±0.1, 0.15±0.1, 0.2±0.1, (3) (4) (5) (6), (1) GND, (7) (8) (9) (10), GND (2), (3)(4)(5)(6): IN (OUT), (7)(8)(9)(10): OUT (IN), Polarity Marking

(Side View) 0.4±0.05, 0.25±0.1, 0.6±0.05, 0.2±0.1

(Bottom View)

■ Electrode (in mm)

■ Equivalent Circuit

■ Packaging

Code	Packaging	Minimum Quantity
L	180mm Reel Embossed Tape	4000
B	Bulk(Bag)	1000

Refer to pages from p.139 to p.144 for mounting information.

■ Rated Value (□: packaging code)

Part Number	Nominal Cut-off Frequency	Insertion Loss (Cut-off Frequency)	Insertion Loss (500MHz) (min.)	Insertion Loss (900MHz) (min.)	Insertion Loss (1500MHz) (min.)	Insertion Loss (2000MHz) (min.)	Rated Voltage	Rated Current	Insulation Resistance (min.)	Withstand Voltage	Kit	QTV
NFA18SD187X1A45□	180MHz	6dBmax	15dB	20dB	20dB	20dB	10Vdc	25mA	1000M ohm	30Vdc	Kit	QTV
NFA18SD207X1A45□	200MHz	6dBmax	13dB	20dB	20dB	20dB	10Vdc	25mA	1000M ohm	30Vdc	Kit	QTV

Operating Temperature Range: -40°C to +85°C Number of Circuits: 4

■ Insertion Loss Characteristics (Main Items)

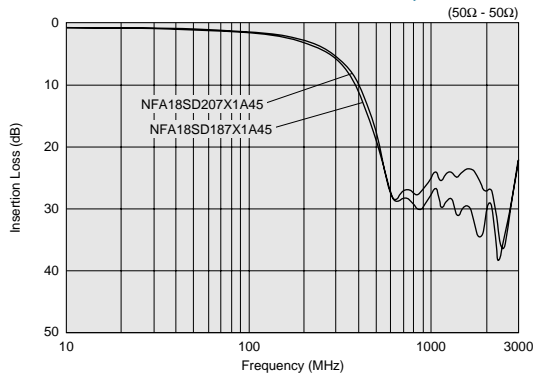

△Note • Please read rating and △CAUTION (for storage, operating, rating, soldering, mounting and handling) in this catalog to prevent smoking and/or burning, etc.
 • This catalog has only typical specifications because there is no space for detailed specifications. Therefore, please review our product specifications or consult the approval sheet for product specifications before ordering.

NFA21SL Series (0805 Size)



L-type LC filter 4-lines array for mobile phones.

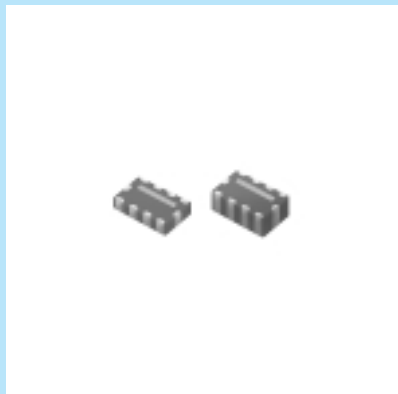

■ Dimensions

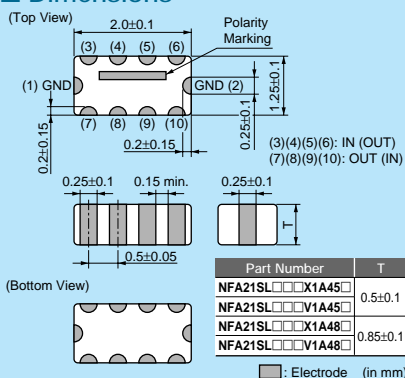

■ Equivalent Circuit

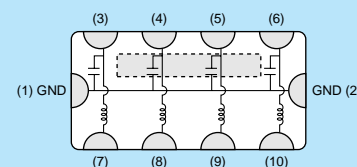

■ Packaging

Code	Packaging	Minimum Quantity
L	180mm Reel Embossed Tape	4000
B	Bulk(Bag)	1000

Refer to pages from p.139 to p.144 for mounting information.

■ Rated Value (□: packaging code)

Part Number	Nominal Cut-off Frequency	Insertion Loss (Cut-off Frequency)	Insertion Loss at 800MHz (min.)	Insertion Loss at 900MHz (min.)	Rated Voltage	Rated Current	Insulation Resistance (min.)	Withstand Voltage	
NFA21SL287V1A45□	280MHz	6dBmax	25dB	25dB	10Vdc	100mA	1000M ohm	30Vdc	Kit
NFA21SL317V1A45□	310MHz	6dBmax	20dB	20dB	10Vdc	100mA	1000M ohm	30Vdc	Kit
NFA21SL337V1A45□	330MHz	6dBmax	15dB	15dB	10Vdc	100mA	1000M ohm	30Vdc	Kit
NFA21SL287V1A48□	280MHz	6dBmax	25dB	25dB	10Vdc	100mA	1000M ohm	30Vdc	Kit
NFA21SL317V1A48□	310MHz	6dBmax	20dB	20dB	10Vdc	100mA	1000M ohm	30Vdc	Kit
NFA21SL337V1A48□	330MHz	6dBmax	20dB	20dB	10Vdc	100mA	1000M ohm	30Vdc	Kit

Operating Temperature Range: -55°C to +125°C Number of Circuits: 4

■ Insertion Loss Characteristics (Main Items)

NFA21SL_V1A45

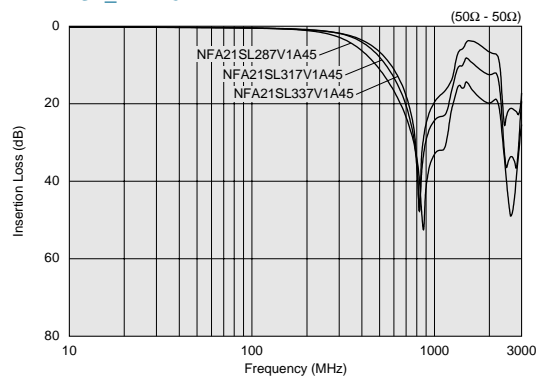

NFA21SL_V1A48

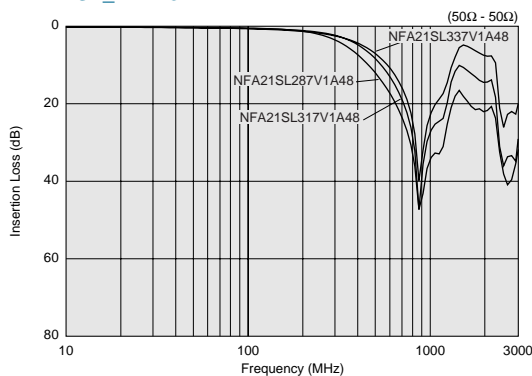

Continued on the following page. ↗

△Note • Please read rating and △CAUTION (for storage, operating, rating, soldering, mounting and handling) in this catalog to prevent smoking and/or burning, etc.
 • This catalog has only typical specifications because there is no space for detailed specifications. Therefore, please review our product specifications or consult the approval sheet for product specifications before ordering.

■ Rated Value (□: packaging code)

Part Number	Nominal Cut-off Frequency	Insertion Loss (Cut-off Frequency)	Insertion Loss at 500MHz (min.)	Insertion Loss at 800MHz (min.)	Insertion Loss at 1000MHz (min.)	Rated Voltage	Rated Current	Insulation Resistance (min.)	Withstand Voltage	
NFA21SL207X1A45□	200MHz	2 to 7	13dB	25dB	25dB	10Vdc	100mA	1000M ohm	30Vdc	Kit
NFA21SL307X1A45□	300MHz	2 to 7	7dB	20dB	25dB	10Vdc	100mA	1000M ohm	30Vdc	Kit
NFA21SL506X1A48□	50MHz	0 to 6	30dB	-	20dB	10Vdc	20mA	1000M ohm	30Vdc	Kit
NFA21SL806X1A48□	80MHz	2 to 7	25dB	-	25dB	10Vdc	20mA	1000M ohm	30Vdc	Kit
NFA21SL207X1A48□	200MHz	2 to 7	13dB	25dB	25dB	10Vdc	100mA	1000M ohm	30Vdc	Kit
NFA21SL307X1A48□	300MHz	2 to 7	7dB	20dB	25dB	10Vdc	100mA	1000M ohm	30Vdc	Kit

Operating Temperature Range: -55°C to +125°C Number of Circuits: 4

■ Insertion Loss Characteristics (Main Items)

NFA21SL_X



Chip Ferrite Bead

Signal Lines Type
Chip EMIFIL®

Chip Common Mode Choke Coil

Block Type EMIFIL®

△Note • Please read rating and △CAUTION (for storage, operating, rating, soldering, mounting and handling) in this catalog to prevent smoking and/or burning, etc.
 • This catalog has only typical specifications because there is no space for detailed specifications. Therefore, please review our product specifications or consult the approval sheet for product specifications before ordering.

NFW31S Series (1206 Size)



Wire-wound PI-type LC filter.



■ Dimensions

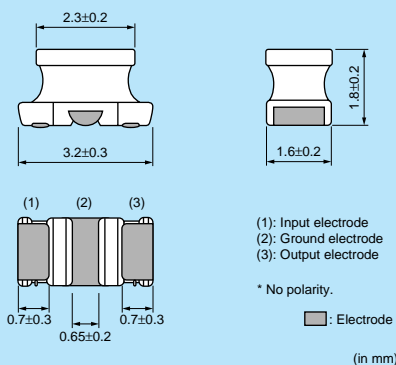

■ Equivalent Circuit



■ Packaging

Code	Packaging	Minimum Quantity
L	180mm Reel Embossed Tape	2000
K	330mm Reel Embossed Tape	7500

Refer to pages from p.139 to p.144 for mounting information.

■ Rated Value (□: packaging code)

Part Number	Nominal Cut-off Frequency	Insertion Loss at 10MHz	Insertion Loss at 20MHz	Insertion Loss at 50MHz	Insertion Loss at 100MHz	Insertion Loss at 150MHz	Insertion Loss at 200MHz	Insertion Loss at 300MHz	Insertion Loss at 400MHz	Insertion Loss at 500MHz	Insertion Loss at 1000MHz	
NFW31SP106X1E4□	10MHz	6dBmax.	5dBmin.	25dBmin.	25dBmin.	-	25dBmin.	-	-	30dBmin.	30dBmin.	Kit
NFW31SP206X1E4□	20MHz	-	6dBmax.	5dBmin.	25dBmin.	-	25dBmin.	-	-	30dBmin.	30dBmin.	Kit
NFW31SP506X1E4□	50MHz	-	-	6dBmax.	10dBmin.	-	30dBmin.	-	-	30dBmin.	30dBmin.	Kit
NFW31SP107X1E4□	100MHz	-	-	-	6dBmax.	-	5dBmin.	-	-	20dBmin.	30dBmin.	Kit
NFW31SP157X1E4□	150MHz	-	-	-	-	6dBmax.	-	10dBmin.	20dBmin.	30dBmin.	30dBmin.	Kit
NFW31SP207X1E4□	200MHz	-	-	-	-	-	6dBmax.	-	-	10dBmin.	30dBmin.	Kit
NFW31SP307X1E4□	300MHz	-	-	-	-	-	-	6dBmax.	-	5dBmin.	15dBmin.	Kit
NFW31SP407X1E4□	400MHz	-	-	-	-	-	-	-	6dBmax.	-	10dBmin.	Kit
NFW31SP507X1E4□	500MHz	-	-	-	-	-	-	-	-	6dBmax.	10dBmin.	Kit

Rated Current: 200mA Rated Voltage: 25Vdc Operating Temperature Range: -40°C to +85°C Number of Circuit: 1

■ Insertion Loss Characteristics (Main Items)



△Note • Please read rating and △CAUTION (for storage, operating, rating, soldering, mounting and handling) in this catalog to prevent smoking and/or burning, etc.
• This catalog has only typical specifications because there is no space for detailed specifications. Therefore, please review our product specifications or consult the approval sheet for product specifications before ordering.

Chip Ferrite Bead

Chip EMIFIL®
Signal Lines Type

Chip Common Mode Choke Coil

Block Type EMIFIL®

Example of EMI Suppression in an Actual Circuit

Measuring Circuit



Type of Filter	Signal Wave Form (20ns/div / 1V/div) / EMI Suppression Effect / Description
Signal Waveform and Noise Spectrum before Filter Mounting	<p>Signal Waveform (20ns/div / 1V/div)</p> <p>Noise Spectrum (10:1 Active Probe)</p>
NFW31S Series (Cut-off frequency 50MHz)	<p>NFW31S's steep attenuation characteristic means excellent EMI suppression without waveform cornering.</p>
Conventional Chip Solid Type EMI Filter (NFM41CC 470pF)	<p>3-terminal capacitors suppress signal frequencies as EMI frequencies so the signal waveform is distorted.</p>
Filter Combined with Conventional LCs	<p>Combinations of inductors and capacitors can yield a steep attenuation characteristic, but they require a great deal more mounting space. Moreover, at high frequencies the EMI suppression is less than that obtained by NFW31S.</p>

△Note • Please read rating and △CAUTION (for storage, operating, rating, soldering, mounting and handling) in this catalog to prevent smoking and/or burning, etc.
• This catalog has only typical specifications because there is no space for detailed specifications. Therefore, please review our product specifications or consult the approval sheet for product specifications before ordering.

NFR21G Series (0805 Size)



3-terminal RC filter, damp the noise current and return back to ground.



■ Dimensions

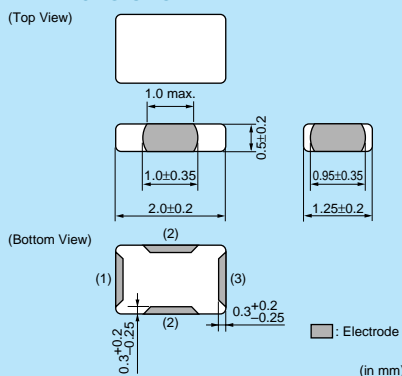

■ Equivalent Circuit

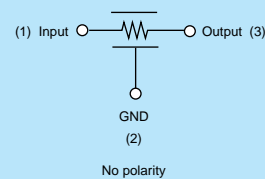

■ Packaging

Code	Packaging	Minimum Quantity
L	180mm Reel Embossed Tape	4000
B	Bulk(Bag)	500

Refer to pages from p.139 to p.144 for mounting information.

■ Rated Value (□: packaging code)

Part Number	Capacitance	DC Resistance	Rated Current	Rated Voltage	Insulation Resistance (min.)	Operating Temperature Range
NFR21GD1002202□	10pF±20%	22ohm±30%	50mA	50Vdc	1000M ohm	-40°C to +85°C
NFR21GD1004702□	10pF±20%	47ohm±30%	35mA	50Vdc	1000M ohm	-40°C to +85°C
NFR21GD4702202□	47pF±20%	22ohm±30%	50mA	50Vdc	1000M ohm	-40°C to +85°C
NFR21GD4704702□	47pF±20%	47ohm±30%	35mA	50Vdc	1000M ohm	-40°C to +85°C
NFR21GD4706802□	47pF±20%	68ohm±30%	30mA	50Vdc	1000M ohm	-40°C to +85°C
NFR21GD4701012□	47pF±20%	100ohm±30%	25mA	50Vdc	1000M ohm	-40°C to +85°C
NFR21GD1012202□	100pF±20%	22ohm±30%	50mA	50Vdc	1000M ohm	-40°C to +85°C
NFR21GD1014702□	100pF±20%	47ohm±30%	35mA	50Vdc	1000M ohm	-40°C to +85°C
NFR21GD1016802□	100pF±20%	68ohm±30%	30mA	50Vdc	1000M ohm	-40°C to +85°C
NFR21GD1011012□	100pF±20%	100ohm±30%	25mA	50Vdc	1000M ohm	-40°C to +85°C

Number of Circuit: 1

■ Insertion Loss Characteristics (Main Items)

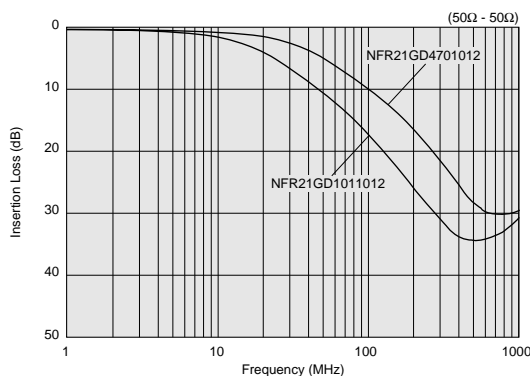
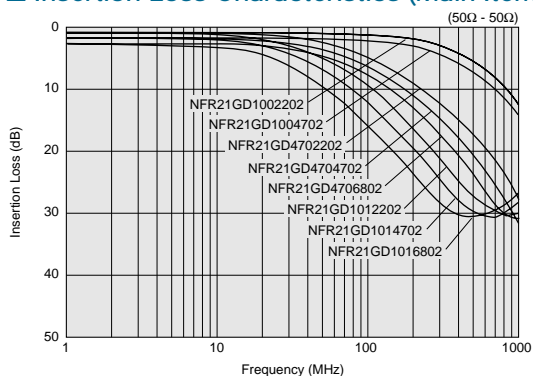

△Note • Please read rating and △CAUTION (for storage, operating, rating, soldering, mounting and handling) in this catalog to prevent smoking and/or burning, etc.
 • This catalog has only typical specifications because there is no space for detailed specifications. Therefore, please review our product specifications or consult the approval sheet for product specifications before ordering.

NFA31G Series (1206 Size)



3-terminal RC filter array.

■ Dimensions

(Top View) (7) (8) (9) (10)

■ Equivalent Circuit

■ Packaging

Code	Packaging	Minimum Quantity
D	180mm Reel Paper Tape	4000
B	Bulk (Bag)	100

Refer to pages from p.139 to p.144 for mounting information.

■ Rated Value (□: packaging code)

Part Number	Capacitance	DC Resistance	Rated Current	Rated Voltage	Insulation Resistance (min.)	Operating Temperature Range
NFA31GD1006R84□	10pF±20%	6.8ohm±40%	50mA	6Vdc	1000M ohm	-40°C to +85°C
NFA31GD1004704□	10pF±20%	47ohm±30%	20mA	6Vdc	1000M ohm	-40°C to +85°C
NFA31GD1001014□	10pF±20%	100ohm±30%	15mA	6Vdc	1000M ohm	-40°C to +85°C
NFA31GD4706R84□	47pF±20%	6.8ohm±40%	50mA	6Vdc	1000M ohm	-40°C to +85°C
NFA31GD4703304□	47pF±20%	33ohm±30%	20mA	6Vdc	1000M ohm	-40°C to +85°C
NFA31GD4704704□	47pF±20%	47ohm±30%	20mA	6Vdc	1000M ohm	-40°C to +85°C
NFA31GD4701014□	47pF±20%	100ohm±30%	15mA	6Vdc	1000M ohm	-40°C to +85°C
NFA31GD1016R84□	100pF±20%	6.8ohm±40%	50mA	6Vdc	1000M ohm	-40°C to +85°C
NFA31GD1014704□	100pF±20%	47ohm±30%	20mA	6Vdc	1000M ohm	-40°C to +85°C
NFA31GD1011014□	100pF±20%	100ohm±30%	15mA	6Vdc	1000M ohm	-40°C to +85°C

Number of Circuit: 4

■ Insertion Loss Characteristics (Main Items)

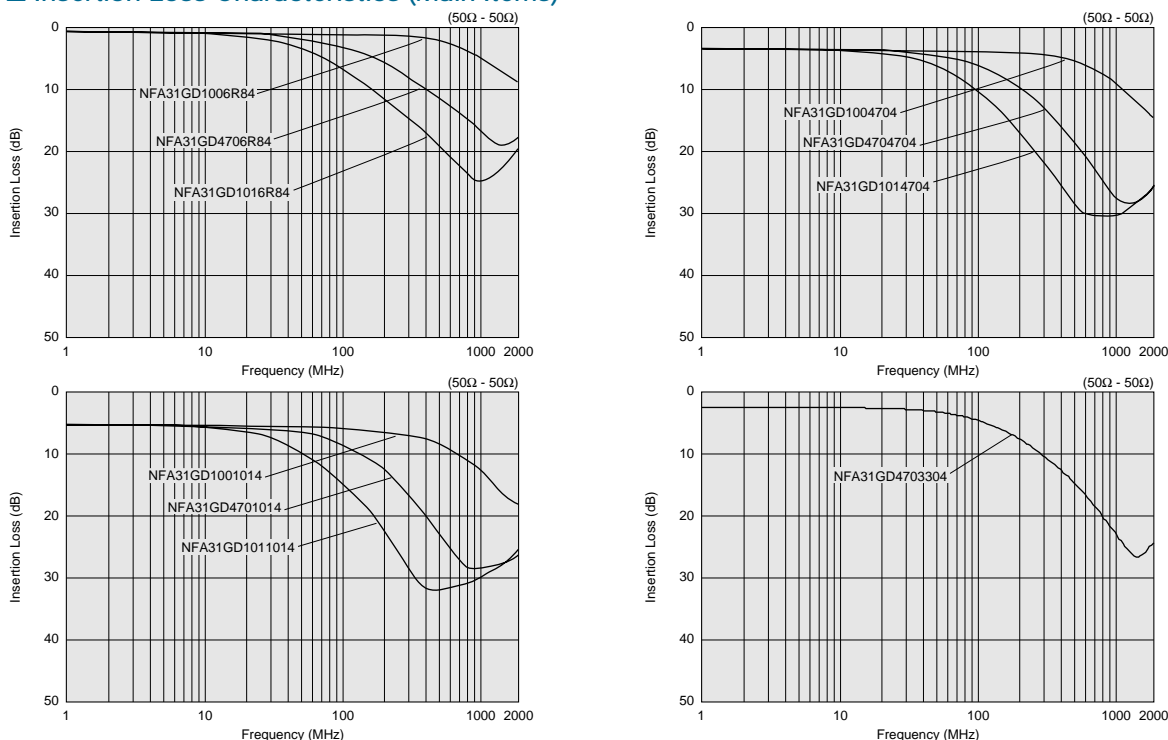

△Note • Please read rating and △CAUTION (for storage, operating, rating, soldering, mounting and handling) in this catalog to prevent smoking and/or burning, etc.
 • This catalog has only typical specifications because there is no space for detailed specifications. Therefore, please review our product specifications or consult the approval sheet for product specifications before ordering.

⚠ Caution

● Rating

Do not use products beyond the rated current and rated voltage as this may create excessive heat and deteriorate the insulation resistance.

● Soldering and Mounting

• Self-heating

Please provide special attention when mounting chip EMIFIL[®] NFM_P series in close proximity to other products that radiate heat.

The heat generated by other products may deteriorate the insulation resistance and cause excessive heat in this component.

Notice

● Storage and Operating Conditions

<Operating Environment>

Do not use products in a chemical atmosphere such as chlorine gas, acid or sulfide gas.

Do not use products in the environment close to the organic solvent.

<Storage and Handling Requirements>

1. Storage Period

NFM55P series should be used within 6 months, the other series should be used within 12 months.

Solderability should be checked if this period is exceeded.

2. Storage Conditions

(1) Storage temperature: -10 to +40°C

Relative humidity: 15 to 85%

Avoid sudden changes in temperature and humidity.

(2) Do not store products in a chemical atmosphere such as chlorine gas, acid or sulfide gas.

● Notice (Soldering and Mounting)

1. Cleaning

Failure and degradation of a product are caused by the cleaning method. When you clean in conditions that are not in mounting information, please contact Murata engineering.

2. Soldering

Reliability decreases with improper soldering methods. Please solder by the standard soldering conditions shown in mounting information.

3. Other

Noise suppression levels resulting from Murata's EMI suppression filters EMIFIL[®] may vary, depending on the circuits and ICs used, type of noise, mounting pattern, mounting location, and other operating conditions. Be sure to check and confirm in advance the noise suppression effect of each filter, in actual circuits, etc. before applying the filter in a commercial-purpose equipment design.

● Handling

1. Resin Coating

Using resin for coating/molding products may affect the products performance.

So please pay careful attention in selecting resin.

Prior to use, please make the reliability evaluation with the product mounted in your application set.

2. Caution for Use (NFW Series)

When you hold products with a tweezer, please hold by the sides. Sharp materials, such as a pair of tweezers or other material such as bristles of cleaning brush, should not touch the winding portion of this product to prevent breaking the wire. Mechanical shock should not be applied to the products mounted on the board to prevent breaking the core.

3. Handling of a Substrate

After mounting products on a substrate, do not apply any stress to the product caused by bending or twisting to the substrate when cropping the substrate, inserting and removing a connector from the substrate or tightening screw to the substrate. Excessive mechanical stress may cause cracking in the Product.

Bending

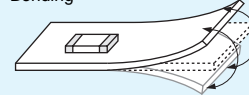

Twisting

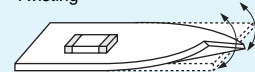

1. Standard Land Pattern Dimensions

NF□ series suppress noise by conducting the high-frequency noise element to ground. Therefore, to obtain maximum performance from these filters, the ground pattern should be made as large as possible during the PCB design stage. As shown below, one side of the PCB is used for chip mounting, and the other is used for grounding.

Small diameter feedthrough holes are then used to connect the grounds on each side of the PCB. This reduces the high-frequency impedance of the grounding and maximizes the filter's performance.

Land Pattern + Solder Resist
 Land Pattern
 Solder Resist (in mm)

NFM18
NFL18
NFM55P

Reflow Soldering

NFM18C/NFM18PC/NFL18ST

NFM18PS

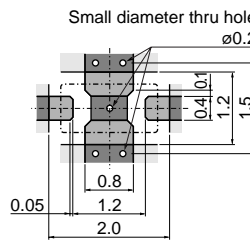
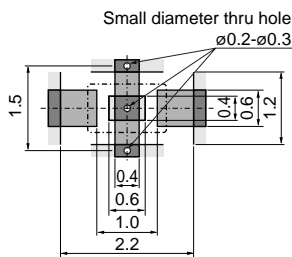

NFL18SP

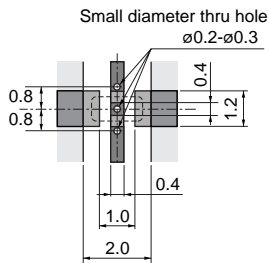

NFM55P

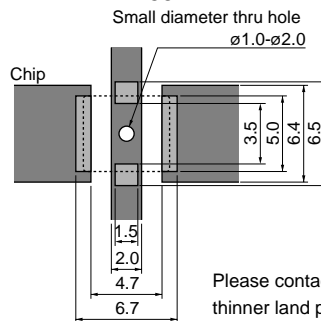

Please contact us if using thinner land pad than 18μm.

• NF□18, NFM55P are specially adapted for reflow soldering.

NFM21C
NFM21P
NFM3D
NFM31P
NFM41
NFR21G
NFL21S

● Reflow Soldering Chip mounting side

NFM21C/NFR21G
NFM21PC/NFL21S

NFM3DC/NFM3DP/
NFM31P
NFM41C/NFM41P

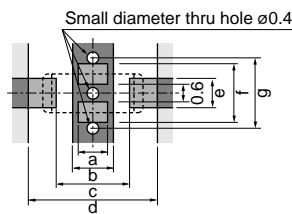
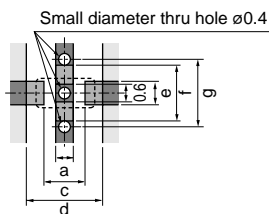

Part Number	Size (mm)						
	a	b	c	d	e	f	g
NFM21C/NFR21G NFM21P/NFL21S	0.6	-	1.4	2.6	0.8	1.9	2.3
NFM3DC/NFM3DP NFM31P	1.0	1.4	2.5	4.4	1.0	2.0	2.4
NFM41C/NFM41P	1.5	2.0	3.5	6.0	1.2	2.6	3.0

• NF□21 is specially adapted for reflow soldering.

● Flow Soldering Chip mounting side

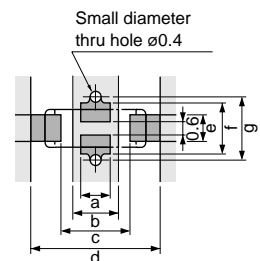

Part Number	Size (mm)						
	a	b	c	d	e	f	g
NFM3DC NFM3DP NFM31P	1.0	1.4	2.5	4.4	1.0	2.0	2.4
NFM41C NFM41P	1.5	2.0	3.5	6.0	1.2	2.6	3.0

Continued on the following page.

Note • Please read rating and **CAUTION** (for storage, operating, rating, soldering, mounting and handling) in this catalog to prevent smoking and/or burning, etc.
• This catalog has only typical specifications because there is no space for detailed specifications. Therefore, please review our product specifications or consult the approval sheet for product specifications before ordering.

Land Pattern + Solder Resist
 Land Pattern
 Solder Resist (in mm)

<p>NFA18S NFA21S</p>	<p>Reflow Soldering</p> <p style="text-align: center;">NFA18S</p>	<p style="text-align: center;">NFA21S</p>
<p>NFA31G NFA31C NFW31S NFE31P</p>	<p>● Reflow Soldering NFA31G/31C</p>	<p>● Reflow and Flow NFW31S ● Reflow Soldering NFE31P</p>
<p>NFE61P</p>	<p>● Reflow Soldering</p>	<p>● Flow Soldering</p>

● PCB Warping

PCB should be designed so that products are not subjected to the mechanical stress caused by warping the board.

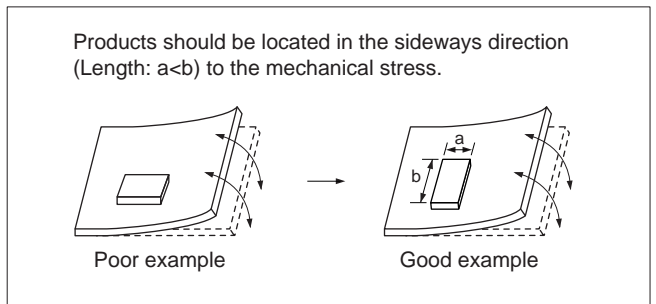

△Note • Please read rating and △CAUTION (for storage, operating, rating, soldering, mounting and handling) in this catalog to prevent smoking and/or burning, etc.
• This catalog has only typical specifications because there is no space for detailed specifications. Therefore, please review our product specifications or consult the approval sheet for product specifications before ordering.

2. Solder Paste Printing and Adhesive Application

When reflow soldering the chip EMI suppression filter, the printing must be conducted in accordance with the following cream solder printing conditions.

If too much solder is applied, the chip will be prone to damage by mechanical and thermal stress from the PCB and may crack.

Standard land dimensions should be used for resist and copper foil patterns.

When flow soldering the EMI suppression filter, apply the adhesive in accordance with the following conditions. If too much adhesive is applied, then it may overflow into the land or termination areas and yield poor solderability. In contrast, if insufficient adhesive is applied, or if the adhesive is not sufficiently hardened, then the chip may become detached during flow soldering process.

(in mm)

Series	Solder Paste Printing	Adhesive Application
<p>NFM NFR NFL</p>	<p>● Guideline of solder paste thickness: 100-150µm: NFM18/21/3D/31P, NFR, NFL 150-200µm: NFM55P 100-200µm: NFM41</p> <div style="display: flex; justify-content: space-around;"> <div style="width: 45%;"> <p>NFM18C/18PC NFL18ST</p> </div> <div style="width: 45%;"> <p>NFL18SP</p> </div> </div> <div style="display: flex; justify-content: space-around; margin-top: 10px;"> <div style="width: 45%;"> <p>NFM18PS</p> </div> <div style="width: 45%;"> <p>NFM21C/21PC NFR21G/NFL21S</p> </div> </div> <div style="display: flex; justify-content: space-around; margin-top: 10px;"> <div style="width: 45%;"> <p>NFM3DC/3DP</p> </div> <div style="width: 45%;"> <p>NFM31P</p> </div> </div> <div style="display: flex; justify-content: space-around; margin-top: 10px;"> <div style="width: 45%;"> <p>NFM41C/41P</p> </div> <div style="width: 45%;"> <p>NFM55P</p> </div> </div>	<p>■ NFM3D/31P/41 Series Apply 0.1mg for NFM41C/41 and 0.06mg for NFM3D/NFM31P of bonding agent at each chip. Do not cover electrodes.</p> <div style="display: flex; justify-content: space-around; align-items: center;"> </div>

Continued on the following page. ↗

△Note • Please read rating and △CAUTION (for storage, operating, rating, soldering, mounting and handling) in this catalog to prevent smoking and/or burning, etc.
 • This catalog has only typical specifications because there is no space for detailed specifications. Therefore, please review our product specifications or consult the approval sheet for product specifications before ordering.

(in mm)

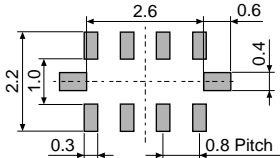
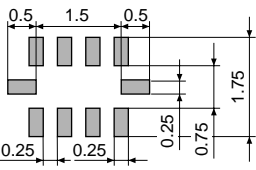
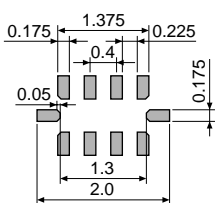
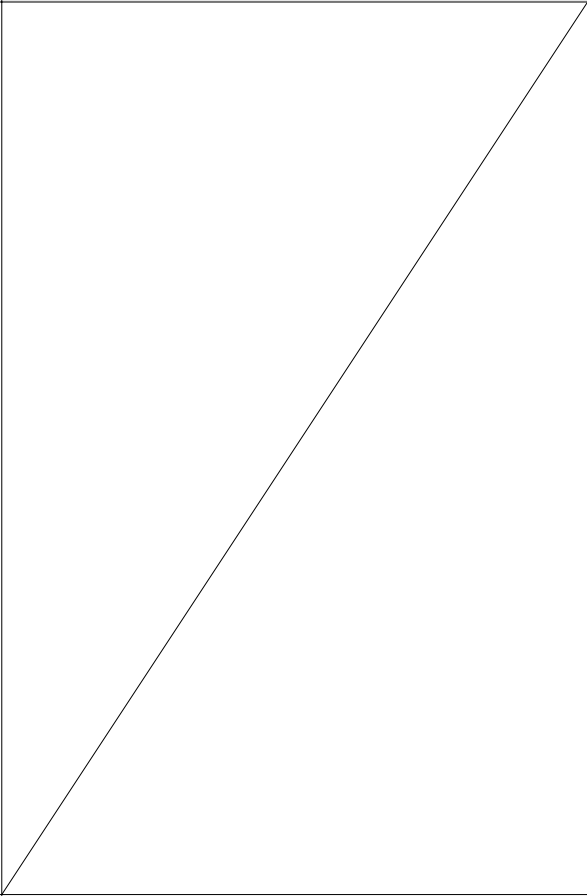
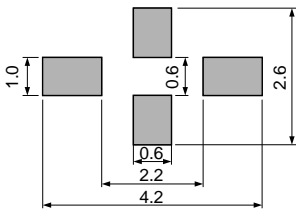
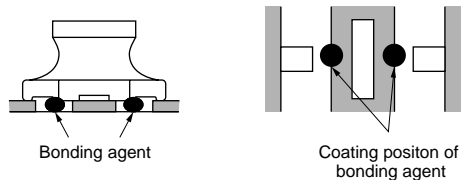
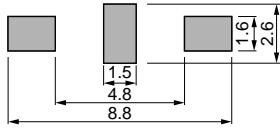
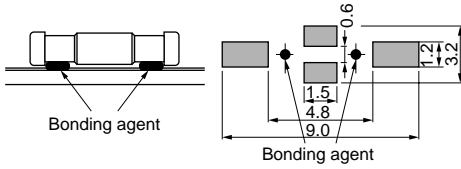
Series	Solder Paste Printing	Adhesive Application
<p>NFA</p>	<p>●Guideline of solder paste thickness: 100-200μm: NFA31G/31C 100-150μm: NFA18S/21S</p> <p>NFA31G/31C</p>  <p>NFA21S</p>  <p>NFA18S</p> 	
<p>NFW31S NFE31P</p>	<p>●Guideline of solder paste thickness: 150-200μm</p> 	<p>■ NFW31S Series Apply 0.2mg of bonding agent at each chip.</p> 
<p>NFE61P</p>	<p>●Guideline of solder paste thickness: 150-200μm</p> 	<p>Apply 1.0mg of bonding agent at each chip.</p> 

△Note • Please read rating and △CAUTION (for storage, operating, rating, soldering, mounting and handling) in this catalog to prevent smoking and/or burning, etc.
 • This catalog has only typical specifications because there is no space for detailed specifications. Therefore, please review our product specifications or consult the approval sheet for product specifications before ordering.

3. Standard Soldering Conditions

(1) Soldering Methods

Use flow and reflow soldering methods only.
 Use standard soldering conditions when soldering chip EMI suppression filters.
 In cases where several different parts are soldered, each having different soldering conditions, use those conditions requiring the least heat and minimum time.

Flux:

- Use Rosin-based flux.
 In case of using RA type solder, products should be cleaned completely with no residual flux.
- Do not use strong acidic flux (with chlorine content exceeding 0.20wt%)
- Do not use water-soluble flux.

Solder: Use Sn-3.0Ag-0.5Cu solder. Use of Sn-Zn based solder will deteriorate performance of products.
 If using NFM series with Sn-Zn based solder, please contact Murata in advance.

For additional mounting methods, please contact Murata.

(2) Soldering Profile

● Flow Soldering Profile (Sn-3.0Ag-0.5Cu Solder)

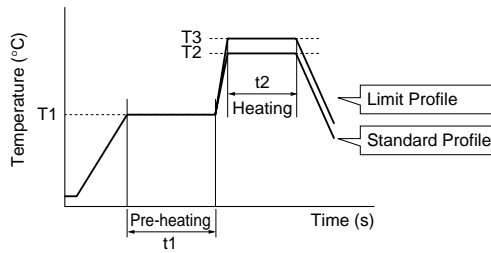

Series	Pre-heating		Standard Profile			Limit Profile		
	Temp. (T1)	Time. (t1)	Heating		Cycle of Flow	Heating		Cycle of Flow
			Temp. (T2)	Time. (t2)		Temp. (T3)	Time. (t2)	
NFM3DC/3DP/31PC NFM41C/41P NFE61P	150°C	60s min.	250°C	4 to 6s	2 times max.	265±3°C	5s max.	2 times max.
NFW31S	150°C	60s min.	250°C	4 to 6s	2 times max.	265±3°C	5s max.	1 time

● Reflow Soldering Profile (Sn-3.0Ag-0.5Cu Solder)

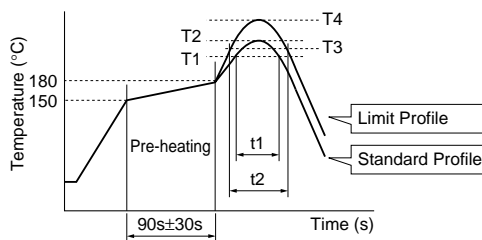

Series	Standard Profile				Limit Profile			
	Heating		Peak Temperature (T2)	Cycle of Reflow	Heating		Peak Temperature (T4)	Cycle of Reflow
	Temp. (T1)	Time. (t1)			Temp. (T3)	Time. (t2)		
NFA, NFE NFL, NFM (Except NFM55P) NFR	220°C min.	30 to 60s	245±3°C	2 times max.	230°C min.	60s max.	260°C/10s	2 times max.
NFW31S, NFM55P	220°C min.	30 to 60s	245±3°C	2 times max.	230°C min.	60s max.	260°C/10s	1 time

△Note • Please read rating and △CAUTION (for storage, operating, rating, soldering, mounting and handling) in this catalog to prevent smoking and/or burning, etc.
 • This catalog has only typical specifications because there is no space for detailed specifications. Therefore, please review our product specifications or consult the approval sheet for product specifications before ordering.

(3) Reworking with Solder Iron

The following conditions must be strictly followed when using a soldering iron.

Pre-heating: 150°C 60s min.*¹

*¹ NFM55P: 100°C/60s+200°C/60s

Soldering iron power output / Tip diameter:

30W max. / ø3mm max.

Temperature of soldering iron tip / Soldering time / Times:

350°C max. / 3-4s / 2 times*²

*² NFE31PT152Z1E9: 280°C max. / 10s max. / 2 times

Do not allow the tip of the soldering iron to directly contact the chip.

For additional methods of reworking with a soldering iron, please contact Murata engineering.

4. Cleaning

Following conditions should be observed when cleaning chip EMI filter.

(1) Cleaning Temperature: 60°C max. (40°C max. for alcohol type cleaner)

(2) Ultrasonic

Output: 20W/liter max.

Duration: 5 minutes max.

Frequency: 28 to 40kHz

(3) Cleaning Agent

The following list of cleaning agents have been tested on the individual components. Evaluation of final assembly should be completed prior to production.

(a) Alcohol cleaning agent

Isopropyl alcohol (IPA)

(b) Aqueous cleaning agent

Pine Alpha ST-100S

(4) Ensure that flux residue is completely removed.

Component should be thoroughly dried after aqueous agent has been removed with deionized water.

■ Minimum Quantity and Dimensions of 8mm Width Paper / Embossed Tape

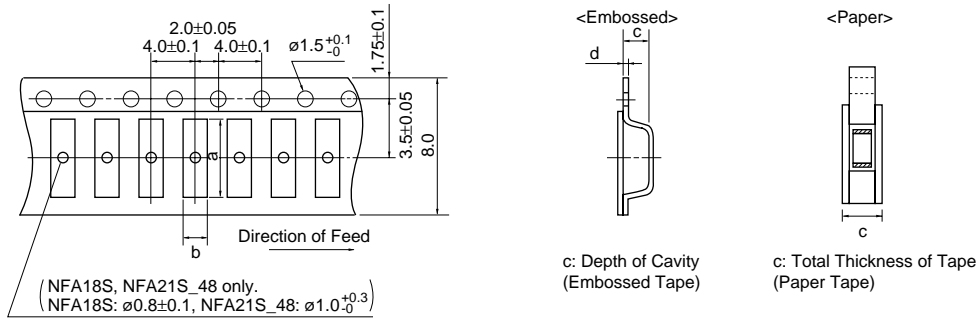

Dimension of the cavity of embossed tape is measured at the bottom side.

Part Number	Cavity Size				Minimum Qty. (pcs.)				Bulk
					ø180mm Reel		ø330mm Reel		
	a	b	c	d	Paper Tape	Embossed Tape	Paper Tape	Embossed Tape	
NFM18C/ NFM18PC (Except 105R/225B1A)/ NFM18PS	1.85	1.05	0.9 max.	-	4000	-	-	-	500
1.1 max.			-	4000	-	-	-	500	
NFM18PC105R/225B1A	1.85	1.05	0.9 max.	-	4000	-	-	-	1000
NFL18ST			1.1 max.	-					
NFL21SP	2.3	1.55	1.1 max.	-	-	-	-	-	500
NFM21	2.3	1.55	1.1 max.	-	4000	-	-	-	500
NFM3DC/3DP	3.4	1.4	0.85	0.2	-	4000	-	-	500
NFM31P	3.5	1.9	1.5	0.25	-	3000	-	-	500
NFA18S	1.8	1.0	0.7	0.25	-	4000	-	-	1000
NFA21S_45	2.30	1.55	0.7	0.25	-	4000	-	-	1000
NFA21S_48	2.25	1.45	1.05	0.25	-	4000	-	-	1000
NFA31G/31C	3.5	2.0	1.1 max.	-	4000	-	-	-	100
NFE31P	3.6	1.8	1.85	0.2	-	2000	-	8000	500
NFR21G	2.3	1.55	0.7	0.25	-	4000	-	-	500
NFW31S	3.6	1.9	2.0	0.2	-	2000	-	7500	-

(in mm)

■ Minimum Quantity and Dimensions of 12mm Width Embossed Tape

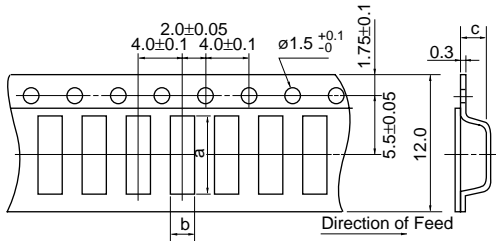

c: Depth of Cavity

Part Number	Cavity Size			Minimum Qty. (pcs.)		
	a	b	c	ø180mm Reel	ø330mm Reel	Bulk
NFM41	4.8	1.8	1.1	4000	-	500
NFE61	7.2	1.9	1.75	2500	8000	500

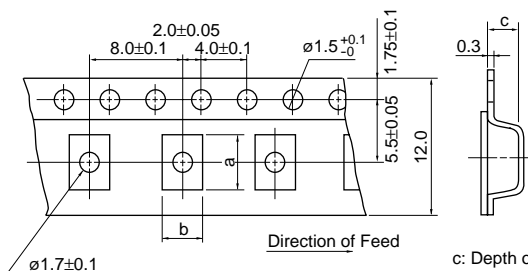

c: Depth of Cavity

Part Number	Cavity Size			Minimum Qty. (pcs.)		
	a	b	c	ø180mm Reel	ø330mm Reel	Bulk
NFM55P	6.0	5.3	2.5	500	-	100

Dimension of the cavity is measured at the bottom side.

(in mm)

"Minimum Quantity" means the number of units of each delivery or order. The quantity should be an integral multiple of the "Minimum Quantity".

⚠Note • Please read rating and ⚠CAUTION (for storage, operating, rating, soldering, mounting and handling) in this catalog to prevent smoking and/or burning, etc.
• This catalog has only typical specifications because there is no space for detailed specifications. Therefore, please review our product specifications or consult the approval sheet for product specifications before ordering.

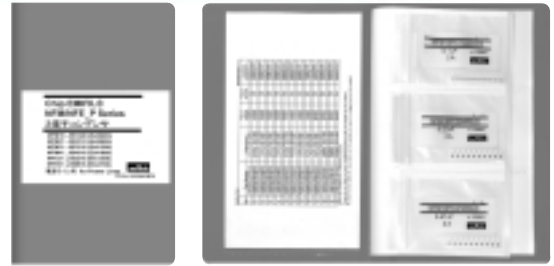

●EKEMNFMCB (Chip EMIFIL® Capacitor Type for Signal Lines)

No.	Part Number	Quantity (pcs.)	Capacitance	Rated Voltage (Vdc)	Rated Current (mA)
1	NFM18CC220U1C3	10	22pF±20%	16	400
2	NFM18CC470U1C3	10	47pF±20%	16	400
3	NFM18CC101R1C3	10	47pF±20%	16	500
4	NFM18CC221R1C3	10	100pF±20%	16	500
5	NFM18CC471R1C3	10	220pF±20%	16	500
6	NFM18CC102R1C3	10	470pF±20%	16	600
7	NFM18CC222R1C3	10	1000pF±20%	16	700
8	NFM18CC223R1C3	10	2200pF±20%	16	1000
9	NFM21CC220U1H3	10	22000pF±20%	50	700
10	NFM21CC470U1H3	10	22pF±20%	50	700
11	NFM21CC101U1H3	10	100pF±20%	50	700
12	NFM21CC221R1H3	10	220pF±20%	50	700
13	NFM21CC471R1H3	10	470pF±20%	50	1000
14	NFM21CC102R1H3	10	1000pF±20%	50	1000
15	NFM21CC222R1H3	10	2200pF±20%	50	1000
16	NFM21CC223R1H3	10	22000pF±20%	50	2000

●EKEMFA31E (Chip EMIFIL® Capacitor Array Type/ RC Combined Array Type)

No.	Part Number	Quantity (pcs.)	Capacitance	Rated Voltage (Vdc)	Rated Current (mA)
1	NFA31CC220S1E4	10	22pF±20%	25	200
2	NFA31CC470S1E4	10	47pF±20%	25	200
3	NFA31CC101S1E4	10	100pF±20%	25	200
4	NFA31CC221S1E4	10	220pF±20%	25	200
5	NFA31CC471R1E4	10	470pF±20%	25	200
6	NFA31CC102R1E4	10	1000pF±20%	25	200
7	NFA31CC222R1E4	10	2200pF±20%	25	200
8	NFA31CC223R1C4	10	22000pF±20%	16	200

●EKEMFL18F (Chip EMIFIL® LC Combined Type)

No.	Part Number	Quantity (pcs.)	Cut-off Frequency	Rated Voltage (Vdc)	Rated Current (mA)	DC Resistance (Ω) max.
1	NFL18ST506H1A3	10	50MHz	10	75	-
2	NFL18ST706H1A3	10	70MHz	10	75	-
3	NFL18ST107H1A3	10	100MHz	10	75	-
4	NFL18ST207X1C3	10	200MHz	16	150	3.5
5	NFL18ST307X1C3	10	300MHz	16	200	1.8
6	NFL18ST507X1C3	10	500MHz	16	200	1.5
7	NFL18SP157X1A3	10	150MHz	10	100	3.0
8	NFL18SP207X1A3	10	200MHz	10	100	3.0
9	NFL18SP307X1A3	10	300MHz	10	100	3.0
10	NFL18SP507X1A3	10	500MHz	10	100	2.0
11	NFL21SP106X1C3	10	10MHz	16	100	8.5
12	NFL21SP206X1C7	10	20MHz	16	100	8.5
13	NFL21SP506X1C3	10	50MHz	16	150	3.5
14	NFL21SP706X1C3	10	70MHz	16	150	3.0
15	NFL21SP107X1C3	10	100MHz	16	200	2.0
16	NFL21SP157X1C3	10	150MHz	16	200	2.0
17	NFL21SP207X1C3	10	200MHz	16	250	1.5
18	NFL21SP307X1C3	10	300MHz	16	300	1.2
19	NFL21SP407X1C3	10	400MHz	16	300	1.2
20	NFL21SP507X1C3	10	500MHz	16	300	1.2

Continued on the following page. ↗

△Note • Please read rating and △CAUTION (for storage, operating, rating, soldering, mounting and handling) in this catalog to prevent smoking and/or burning, etc.
 • This catalog has only typical specifications because there is no space for detailed specifications. Therefore, please review our product specifications or consult the approval sheet for product specifications before ordering.

Continued from the preceding page.

No.	Part Number	Quantity (pcs.)	Cut-off Frequency	Attenuation (dB min.)										Rated Current	Rated Voltage
				10MHz	20MHz	50MHz	100MHz	150MHz	200MHz	300MHz	400MHz	500MHz	1GHz		
21	NFW31SP106X1E4	10	10MHz	6dB max.	5	25	25	-	25	-	-	30	30	200mA	25V
22	NFW31SP206X1E4	10	20MHz	-	6dB max.	5	25	-	25	-	-	30	30	200mA	25V
23	NFW31SP506X1E4	10	50MHz	-	-	6dB max.	10	-	30	-	-	30	30	200mA	25V
24	NFW31SP107X1E4	10	100MHz	-	-	-	6dB max.	-	5	-	-	20	30	200mA	25V
25	NFW31SP157X1E4	10	150MHz	-	-	-	-	6dB max.	-	10	20	30	30	200mA	25V
26	NFW31SP207X1E4	10	200MHz	-	-	-	-	-	6dB max.	-	-	10	30	200mA	25V
27	NFW31SP307X1E4	10	300MHz	-	-	-	-	-	-	6dB max.	-	5	15	200mA	25V
28	NFW31SP407X1E4	10	400MHz	-	-	-	-	-	-	-	6dB max.	-	10	200mA	25V
29	NFW31SP507X1E4	10	500MHz	-	-	-	-	-	-	-	-	6dB max.	10	200mA	25V

●EKEMFA20H (Chip EMIFIL® LC Combined Array Type)

No.	Part Number	Quantity (pcs.)	Cut-off Frequency	Rated Voltage (Vdc)	Rated Current (mA)
1	NFA18SL506X1A45	10	50MHz	10	25
2	NFA18SL137V1A45	10	130MHz	10	50
3	NFA18SL187V1A45	10	180MHz	10	50
4	NFA18SL207V1A45	10	200MHz	10	50
5	NFA18SL227V1A45	10	220MHz	10	25
6	NFA18SL307V1A45	10	300MHz	10	100
7	NFA18SL357V1A45	10	350MHz	10	35
8	NFA18SL407V1A45	10	400MHz	10	100
9	NFA18SL487V1A45	10	480MHz	10	100
10	NFA18SD187X1A45	10	180MHz	10	25
11	NFA18SD207X1A45	10	200MHz	10	25
12	NFA21SL506X1A48	10	200MHz	10	25
13	NFA21SL806X1A48	10	80MHz	10	20
14	NFA21SL207X1A45	10	200MHz	10	100
15	NFA21SL207X1A48	10	200MHz	10	100
16	NFA21SL307X1A45	10	300MHz	10	100
17	NFA21SL307X1A48	10	300MHz	10	100
18	NFA21SL287V1A45	10	280MHz	10	100
19	NFA21SL287V1A48	10	280MHz	10	100
20	NFA21SL317V1A45	10	310MHz	10	100
21	NFA21SL317V1A48	10	310MHz	10	100
22	NFA21SL337V1A45	10	330MHz	10	100
23	NFA21SL337V1A48	10	330MHz	10	100

●EKEMNFMPH (Chip EMIFIL® for Large Current)

No.	Part Number	Quantity (pcs.)	Capacitance	Rated Voltage (Vdc)	Rated Current (A)
1	NFM18PC104R1C3	10	0.1µF±20%	16	2
2	NFM18PC224R0J3	10	0.22µF±20%	6.3	2
3	NFM18PC474R0J3	10	0.47µF±20%	6.3	2
4	NFM18PC105R0J3	10	1µF±20%	6.3	4
5	NFM18PC225B0J3	10	2.2µF±20%	6.3	2
6	NFM18PC225B1A3	10	2.2µF±20%	10	4
7	NFM18PS474R0J3	10	0.47µF±20%	6.3	2
8	NFM18PS105R0J3	10	1µF±20%	6.3	2
9	NFM21PC104R1E3	10	0.1µF±20%	25	2
10	NFM21PC224R1C3	10	0.22µF±20%	16	2
11	NFM21PC474R1C3	10	0.47µF±20%	16	2
12	NFM21PC105B1A3	10	1µF±20%	10	4
13	NFM21PC105B1C3	10	1µF±20%	16	4
14	NFM21PC225B0J3	10	2.2µF±20%	6.3	4
15	NFM21PC475B1A3	10	4.7µF±20%	10	6
16	NFM31PC276B0J3	10	27µF±20%	6.3	6
17	NFM41PC204F1H3	10	0.2µF +80/-20%	50	2
18	NFM41PC155B1E3	10	1.5µF±20%	25	6
19	NFE31PT152Z1E9	10	1500pF +50/-20%	25	6
20	NFE31PT222Z1E9	10	2200pF±50%	25	6
21	NFE61PT102E1H9	10	1000pF +80/-20%	50	2
22	NFE61PT472C1H9	10	4700pF +80/-20%	50	2

△Note • Please read rating and △CAUTION (for storage, operating, rating, soldering, mounting and handling) in this catalog to prevent smoking and/or burning, etc.
 • This catalog has only typical specifications because there is no space for detailed specifications. Therefore, please review our product specifications or consult the approval sheet for product specifications before ordering.



Компания «ЭлектроПласт» предлагает заключение долгосрочных отношений при поставках импортных электронных компонентов на взаимовыгодных условиях!

Наши преимущества:

- Оперативные поставки широкого спектра электронных компонентов отечественного и импортного производства напрямую от производителей и с крупнейших мировых складов;
- Поставка более 17-ти миллионов наименований электронных компонентов;
- Поставка сложных, дефицитных, либо снятых с производства позиций;
- Оперативные сроки поставки под заказ (от 5 рабочих дней);
- Экспресс доставка в любую точку России;
- Техническая поддержка проекта, помощь в подборе аналогов, поставка прототипов;
- Система менеджмента качества сертифицирована по Международному стандарту ISO 9001;
- Лицензия ФСБ на осуществление работ с использованием сведений, составляющих государственную тайну;
- Поставка специализированных компонентов (Xilinx, Altera, Analog Devices, Intersil, Interpoint, Microsemi, Aeroflex, Peregrine, Syfer, Eurofarad, Texas Instrument, Miteq, Cobham, E2V, MA-COM, Hittite, Mini-Circuits, General Dynamics и др.);

Помимо этого, одним из направлений компании «ЭлектроПласт» является направление «Источники питания». Мы предлагаем Вам помощь Конструкторского отдела:

- Подбор оптимального решения, техническое обоснование при выборе компонента;
- Подбор аналогов;
- Консультации по применению компонента;
- Поставка образцов и прототипов;
- Техническая поддержка проекта;
- Защита от снятия компонента с производства.



Как с нами связаться

Телефон: 8 (812) 309 58 32 (многоканальный)

Факс: 8 (812) 320-02-42

Электронная почта: org@eplast1.ru

Адрес: 198099, г. Санкт-Петербург, ул. Калинина, дом 2, корпус 4, литера А.