

PBA10F

① PB ② A ③ 10 ④ F ⑤ -□ ⑥ -□



Recommended EMI/EMC Filter
NAC-06-472



High voltage pulse noise type : NAP series
Low leakage current type : NAM series
*The EMI/EMC Filter is recommended to connect with several devices.

- ① Series name
- ② Single output
- ③ Output wattage
- ④ Universal input
- ⑤ Output voltage
- ⑥ Optional *5
- C :with Coating
- G :Low leakage current
- E :Low leakage current and EMI class A
- T :Vertical terminal block
- J :Connector type
- N :with Cover (UL508 is acquired)
- N1 :with DIN rail and Cover
- V :Output voltage setting potentiometer externally

Cover is optional

MODEL	PBA10F-5	PBA10F-12	PBA10F-24
MAX OUTPUT WATTAGE[W]	10	10.8	12
DC OUTPUT	5V 2A	12V 0.9A	24V 0.5A

SPECIFICATIONS

	MODEL	PBA10F-5	PBA10F-12	PBA10F-24	
INPUT	VOLTAGE[V]	AC85 - 264 1 φ or DC110 - 370 (AC50 or DC70 Please refer to the instruction manual 2.1 Input voltage *3)			
	CURRENT[A]	ACIN 100V	0.30typ (Io=100%)		
		ACIN 200V	0.20typ (Io=100%)		
	FREQUENCY[Hz]	50/60 (47 - 440) or DC			
	EFFICIENCY[%]	ACIN 100V	74typ	76typ	77typ
		ACIN 200V	74typ	76typ	77typ
	INRUSH CURRENT[A]	ACIN 100V	15typ (Io=100%)		
	ACIN 200V	30typ (Io=100%)			
LEAKAGE CURRENT[ma]	0.15/0.30max (ACIN 100V/240V 60Hz, Io=100%, According to IEC60950-1.DENAN)				
OUTPUT	VOLTAGE[V]	5	12	24	
	CURRENT[A]	2	0.9	0.5	
	LINE REGULATION[mV] *6	20max	48max	96max	
	LOAD REGULATION[mV] *6	40max	100max	150max	
	RIPPLE[mVp-p]	0 to +50°C *1	80max	120max	120max
		-10 - 0°C *1	140max	160max	160max
	RIPPLE NOISE[mVp-p]	0 to +50°C *1	120max	150max	150max
		-10 - 0°C *1	160max	180max	180max
	TEMPERATURE REGULATION[mV]	0 to +50°C	50max	120max	240max
		-10 to +50°C	60max	150max	290max
	DRIFT[mV] *2	20max	48max	96max	
	START-UP TIME[ms]	200typ(ACIN 100V, Io=100%) * Start-up time is 700ms typ for less than 1 minute of applying input again from turning off the input voltage.			
HOLD-UP TIME[ms]	20typ (ACIN 100V, Io=100%)				
OUTPUT VOLTAGE ADJUSTMENT RANGE[V]	4.50 - 5.50	10.0 - 13.2	19.2 - 27.0		
OUTPUT VOLTAGE SETTING[V]	5.00 - 5.15	12.00 - 12.48	24.00 - 24.96		
PROTECTION CIRCUIT AND OTHERS	OVERCURRENT PROTECTION	Works over 105% of rated current and recovers automatically			
	OVERVOLTAGE PROTECTION[V]	5.75 - 7.00	15.0 - 18.0	30.0 - 37.0	
	OPERATING INDICATION	LED (Green)			
	REMOTE ON/OFF	None			
ISOLATION	INPUT-OUTPUT	AC3,000V 1minute, Cutoff current = 10mA, DC500V 50MΩmin (At Room Temperature)			
	INPUT-FG	AC2,000V 1minute, Cutoff current = 10mA, DC500V 50MΩmin (At Room Temperature)			
	OUTPUT-FG	AC500V 1minute, Cutoff current = 25mA, DC500V 50MΩmin (At Room Temperature)			
ENVIRONMENT	OPERATING TEMP.,HUMID.AND ALTITUDE	-10 to +71°C (Required Derating), 20 - 90%RH (Non condensing) 3,000m (10,000feet) max			
	STORAGE TEMP.,HUMID.AND ALTITUDE	-20 to +75°C, 20 - 90%RH (Non condensing) 9,000m (30,000feet) max			
	VIBRATION	10 - 55Hz, 19.6m/s ² (2G), 3minutes period, 60minutes each along X, Y and Z axis			
	IMPACT	196.1m/s ² (20G), 11ms, once each X, Y and Z axis			
SAFETY AND NOISE REGULATIONS	AGENCY APPROVALS (At only AC input)	UL60950-1, C-UL(CSA60950-1), EN60950-1, EN50178 Complies with DEN-AN			
	CONDUCTED NOISE	Complies with FCC Part15 classB, VCCI-B, CISPR22-B, EN55011-B, EN55022-B			
	HARMONIC ATTENUATOR	Complies with IEC61000-3-2 (Not built-in to active filter *4) *7			
OTHERS	CASE SIZE/WEIGHT	31 x 78 x 68mm [1.22 x 3.07 x 2.68 inches] (without terminal block) (W x H x D) / 150g max (with cover : 180g max)			
	COOLING METHOD	Convection			

*1 Measured by 20MHz oscilloscope or Ripple-Noise meter(equivalent to KEISOKU-GIKEN :RM101).
 *2 Drift is the change in DC output for an eight hour period after a half-hour warm-up at 25°C.
 *3 Derating is required.
 *4 When two or more units are used,they may not comply with the harmonic attenuator. Please contact us for details.

*5 Please contact us about safety approvals for the model with option.
 *6 Please contact us about dynamic load and input response.
 *7 Please contact us about class C.
 * Parallel operation with other model is not possible.
 * Derating is required when operated with cover.
 * A sound may occur from power supply at peak loading.

Block diagram



External view

※ External size of option T,J,N,N1 and V is different from standard model and refer to 7 Option of instruction manual for details.



- ※ Tolerance : ± 1 [± 0.04]
- ※ Weight : 150g max (with cover : 180g max)
- ※ PCB Material/thickness : CEM3 / 1.6mm [0.06]
- ※ Chassis material : Electric galvanizing steel board
- ※ Dimensions in mm, [] = inches
- ※ Mounting torque : $0.6\text{N} \cdot \text{m}$ ($6.3\text{kgf} \cdot \text{cm}$) max
- ※ Screw tightening torque : $M3\ 0.8\text{N} \cdot \text{m}$ ($8.5\text{kgf} \cdot \text{cm}$) max
- ※ Please connect safety ground to the unit in 2-M3 holes.

PBA15F

PB A 15 F - □ - □
 ① ② ③ ④ ⑤ ⑥

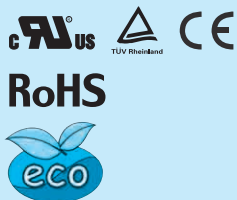

Recommended EMI/EMC Filter
 NAC-06-472



High voltage pulse noise type : NAP series
 Low leakage current type : NAM series
 *The EMI/EMC Filter is recommended to connect with several devices.

- ① Series name
- ② Single output
- ③ Output wattage
- ④ Universal input
- ⑤ Output voltage
- ⑥ Optional *5
- C :with Coating
- G :Low leakage current
- E :Low leakage current and EMI class A
- T :Vertical terminal block
- J :Connector type
- N :with Cover (UL508 is acquired [5V, 12V, 24V])
- Nt :with DIN rail and Cover
- V :Output voltage setting potentiometer externally

Cover is optional

MODEL	PBA15F-3R3	PBA15F-5	PBA15F-9	PBA15F-12	PBA15F-15	PBA15F-24	PBA15F-48
MAX OUTPUT WATTAGE[W]	9.9	15	15.3	15.6	15	16.8	16.8
DC OUTPUT	3.3V 3A	5V 3A	9V 1.7A	12V 1.3A	15V 1A	24V 0.7A	48V 0.35A

SPECIFICATIONS

	MODEL	PBA15F-3R3	PBA15F-5	PBA15F-9	PBA15F-12	PBA15F-15	PBA15F-24	PBA15F-48	
INPUT	VOLTAGE[V]	AC85 - 264 1 φ or DC110 - 370 (AC50 or DC70 Please refer to the instruction manual 2.1 Input voltage *3)							
	CURRENT[A]	ACIN 100V	0.30typ (Io=100%)	0.4typ (Io=100%)					
		ACIN 200V	0.15typ (Io=100%)	0.2typ (Io=100%)					
	FREQUENCY[Hz]	50/60 (47 - 440) or DC							
	EFFICIENCY[%]	ACIN 100V	68typ	74typ	75typ	75typ	77typ	75typ	75typ
		ACIN 200V	68typ	75typ	77typ	78typ	80typ	78typ	78typ
	INRUSH CURRENT[A]	ACIN 100V	15typ (Io=100%) (At cold start)						
ACIN 200V		30typ (Io=100%) (At cold start)							
LEAKAGE CURRENT[ma]	0.15/0.30max (ACIN 100V/240V 60Hz, Io=100%, According to IEC60950-1.DENAN)								
OUTPUT	VOLTAGE[V]	3.3	5	9	12	15	24	48	
	CURRENT[A]	3	3	1.7	1.3	1	0.7	0.35	
	LINE REGULATION[mV] *6	20max	20max	36max	48max	60max	96max	192max	
	LOAD REGULATION[mV] *6	40max	40max	100max	100max	120max	150max	240max	
	RIPPLE[mVp-p]	0 to +50°C *1	80max	80max	120max	120max	120max	120max	150max
		-10 - 0°C *1	140max	140max	160max	160max	160max	160max	200max
	RIPPLE NOISE[mVp-p]	0 to +50°C *1	120max	120max	150max	150max	150max	150max	250max
		-10 - 0°C *1	160max	160max	180max	180max	180max	180max	300max
	TEMPERATURE REGULATION[mV]	0 to +50°C	50max	50max	90max	120max	150max	240max	480max
		-10 to +50°C	60max	60max	120max	150max	180max	290max	600max
	DRIFT[mV] *2	20max	20max	36max	48max	60max	96max	192max	
START-UP TIME[ms]	200typ(ACIN 100V, Io=100%) * Start-up time is 700ms typ for less than 1minute of applying input again from turning off the input voltage.								
HOLD-UP TIME[ms]	20typ (ACIN 100V, Io=100%)								
OUTPUT VOLTAGE ADJUSTMENT RANGE[V]	2.85 - 3.60	4.50 - 5.50	7.50 - 10.0	10.0 - 13.2	13.2 - 18.0	19.2 - 27.0	39.0 - 53.0		
OUTPUT VOLTAGE SETTING[V]	3.30 - 3.40	5.00 - 5.15	9.00 - 9.36	12.00 - 12.48	15.00 - 15.60	24.00 - 24.96	48.00 - 49.92		
PROTECTION CIRCUIT AND OTHERS	OVERCURRENT PROTECTION	Works over 105% of rated current and recovers automatically							
	OVERVOLTAGE PROTECTION[V]	4.00 - 5.25	5.75 - 7.00	11.5 - 14.0	15.0 - 18.0	20.0 - 25.0	30.0 - 37.0	58.0 - 65.0	
	OPERATING INDICATION	LED (Green)							
	REMOTE ON/OFF	None							
ISOLATION	INPUT-OUTPUT	AC3,000V 1minute, Cutoff current = 10mA, DC500V 50MΩmin (At Room Temperature)							
	INPUT-FG	AC2,000V 1minute, Cutoff current = 10mA, DC500V 50MΩmin (At Room Temperature)							
	OUTPUT-FG	AC500V 1minute, Cutoff current = 25mA, DC500V 50MΩmin (At Room Temperature)							
ENVIRONMENT	OPERATING TEMP.,HUMID.AND ALTITUDE	-10 to +71°C (Required Derating), 20 - 90%RH (Non condensing) 3,000m (10,000feet) max							
	STORAGE TEMP.,HUMID.AND ALTITUDE	-20 to +75°C, 20 - 90%RH (Non condensing) 9,000m (30,000feet) max							
	VIBRATION	10 - 55Hz, 19.6m/s ² (2G), 3minutes period, 60minutes each along X, Y and Z axis							
	IMPACT	196.1m/s ² (20G), 11ms, once each X, Y and Z axis							
SAFETY AND NOISE REGULATIONS	AGENCY APPROVALS (At only AC input)	UL60950-1, C-UL(CSA60950-1), EN60950-1, EN50178 Complies with DEN-AN							
	CONDUCTED NOISE	Complies with FCC Part15 classB, VCCI-B, CISPR22-B, EN55011-B, EN55022-B							
	HARMONIC ATTENUATOR	Complies with IEC61000-3-2 (Not built-in to active filter *4) *7							
OTHERS	CASE SIZE/WEIGHT	31 × 78 × 85mm [1.22 × 3.07 × 3.35 inches] (without terminal block) (W×H×D) / 200g max (with cover : 235g max)							
	COOLING METHOD	Convection							

*1 Measured by 20MHz oscilloscope or Ripple-Noise meter(equivalent to KEISOKU-GIKEN :RM101).
 *2 Drift is the change in DC output for an eight hour period after a half-hour warm-up at 25°C.
 *3 Derating is required.
 *4 When two or more units are used,they may not comply with the harmonic attenuator. Please contact us for details.

*5 Please contact us about safety approvals for the model with option.
 *6 Please contact us about dynamic load and input response.
 *7 Please contact us about class C.
 * Parallel operation with other model is not possible.
 * Derating is required when operated with cover.
 * A sound may occur from power supply at peak loading.

Block diagram



External view

※ External size of option T,J,N,N1 and V is different from standard model and refer to 7 Option of instruction manual for details.



- ※ Tolerance : ±1 [±0.04]
- ※ Weight : 200g max (with cover : 235g max)
- ※ PCB Material/thickness : CEM3 / 1.6mm [0.06]
- ※ Chassis material : Electric galvanizing steel board
- ※ Dimensions in mm, [] = inches
- ※ Mounting torque : 0.6N • m(6.3kgf • cm)max
- ※ Screw tightening torque : M3 0.8N • m(8.5kgf • cm)max
- ※ Please connect safety ground to the unit in 2-M3 holes.

PBA30F

PB A 30 F - □ - □
 ① ② ③ ④ ⑤ ⑥

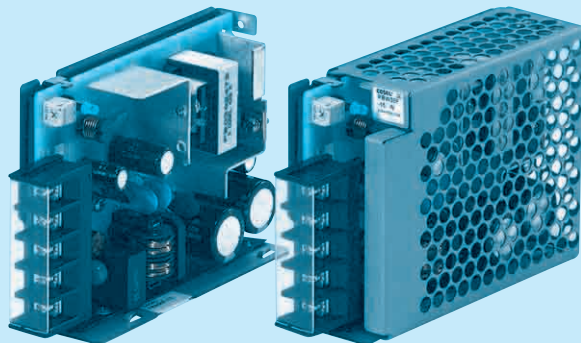
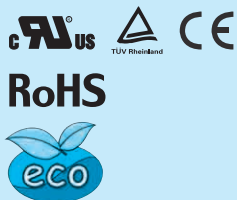

Recommended EMI/EMC Filter
 NAC-06-472



High voltage pulse noise type : NAP series
 Low leakage current type : NAM series
 *The EMI/EMC Filter is recommended to connect with several devices.

- ① Series name
- ② Single output
- ③ Output wattage
- ④ Universal input
- ⑤ Output voltage
- ⑥ Optional *5
- C :with Coating
- G :Low leakage current
- E :Low leakage current and EMI class A
- T :Vertical terminal block
- J :Connector type
- N :with Cover (UL508 is acquired [5V, 12V, 24V])
- Nt :with DIN rail and Cover
- V :Output voltage setting potentiometer externally

Cover is optional

MODEL	PBA30F-3R3	PBA30F-5	PBA30F-9	PBA30F-12	PBA30F-15	PBA30F-24	PBA30F-48
MAX OUTPUT WATTAGE[W]	19.8	30	30.6	30	30	31.2	31.2
DC OUTPUT	3.3V 6A	5V 6A	9V 3.4A	12V 2.5A	15V 2A	24V 1.3A	48V 0.65A

SPECIFICATIONS

	MODEL	PBA30F-3R3	PBA30F-5	PBA30F-9	PBA30F-12	PBA30F-15	PBA30F-24	PBA30F-48	
INPUT	VOLTAGE[V]	AC85 - 264 1 φ or DC110 - 370 (AC50 or DC70 Please refer to the instruction manual 2.1 Input voltage *3)							
	CURRENT[A]	ACIN 100V	0.50typ (Io=100%)	0.70typ (Io=100%)					
		ACIN 200V	0.30typ (Io=100%)	0.40typ (Io=100%)					
	FREQUENCY[Hz]	50/60 (47 - 440) or DC							
	EFFICIENCY[%]	ACIN 100V	68typ	74typ	75typ	76typ	78typ	78typ	79typ
		ACIN 200V	69typ	77typ	77typ	78typ	81typ	81typ	81typ
	INRUSH CURRENT[A]	ACIN 100V	15typ (Io=100%) (At cold start)						
	ACIN 200V	30typ (Io=100%) (At cold start)							
LEAKAGE CURRENT[ma]	0.30/0.65max (ACIN 100V/240V 60Hz, Io=100%, According to IEC60950-1.DENAN)								
OUTPUT	VOLTAGE[V]	3.3	5	9	12	15	24	48	
	CURRENT[A]	6	6	3.4	2.5	2	1.3	0.65	
	LINE REGULATION[mV] *6	20max	20max	36max	48max	60max	96max	192max	
	LOAD REGULATION[mV] *6	40max	40max	100max	100max	120max	150max	240max	
	RIPPLE[mVp-p]	0 to +50°C *1	80max	80max	120max	120max	120max	120max	150max
		-10 - 0°C *1	140max	140max	160max	160max	160max	160max	200max
	RIPPLE NOISE[mVp-p]	0 to +50°C *1	120max	120max	150max	150max	150max	150max	250max
		-10 - 0°C *1	160max	160max	180max	180max	180max	180max	300max
	TEMPERATURE REGULATION[mV]	0 to +50°C	50max	50max	90max	120max	150max	240max	480max
		-10 to +50°C	60max	60max	120max	150max	180max	290max	600max
	DRIFT[mV] *2	20max	20max	36max	48max	60max	96max	192max	
START-UP TIME[ms]	200typ(ACIN 100V, Io=100%) * Start-up time is 700ms typ for less than 1minute of applying input again from turning off the input voltage.								
HOLD-UP TIME[ms]	20typ (ACIN 100V, Io=100%)								
OUTPUT VOLTAGE ADJUSTMENT RANGE[V]	2.85 - 3.60	4.50 - 5.50	7.50 - 10.0	10.0 - 13.2	13.2 - 18.0	19.2 - 27.0	39.0 - 53.0		
OUTPUT VOLTAGE SETTING[V]	3.30 - 3.40	5.00 - 5.15	9.00 - 9.36	12.00 - 12.48	15.00 - 15.60	24.00 - 24.96	48.00 - 49.92		
PROTECTION CIRCUIT AND OTHERS	OVERCURRENT PROTECTION	Works over 105% of rated current and recovers automatically							
	OVERVOLTAGE PROTECTION[V]	4.00 - 5.25	5.75 - 7.00	11.5 - 14.0	15.0 - 18.0	20.0 - 25.0	30.0 - 37.0	58.0 - 65.0	
	OPERATING INDICATION	LED (Green)							
	REMOTE ON/OFF	None							
ISOLATION	INPUT-OUTPUT	AC3,000V 1minute, Cutoff current = 10mA, DC500V 50MΩmin (At Room Temperature)							
	INPUT-FG	AC2,000V 1minute, Cutoff current = 10mA, DC500V 50MΩmin (At Room Temperature)							
	OUTPUT-FG	AC500V 1minute, Cutoff current = 25mA, DC500V 50MΩmin (At Room Temperature)							
ENVIRONMENT	OPERATING TEMP.,HUMID.AND ALTITUDE	-10 to +71°C (Required Derating), 20 - 90%RH (Non condensing) 3,000m (10,000feet) max							
	STORAGE TEMP.,HUMID.AND ALTITUDE	-20 to +75°C, 20 - 90%RH (Non condensing) 9,000m (30,000feet) max							
	VIBRATION	10 - 55Hz, 19.6m/s ² (2G), 3minutes period, 60minutes each along X, Y and Z axis							
	IMPACT	196.1m/s ² (20G), 11ms, once each X, Y and Z axis							
SAFETY AND NOISE REGULATIONS	AGENCY APPROVALS (At only AC input)	UL60950-1, C-UL(CSA60950-1), EN60950-1, EN50178 Complies with DEN-AN							
	CONDUCTED NOISE	Complies with FCC Part15 classB, VCCI-B, CISPR22-B, EN55011-B, EN55022-B							
	HARMONIC ATTENUATOR	Complies with IEC61000-3-2 (Not built-in to active filter *4) *7							
OTHERS	CASE SIZE/WEIGHT	31 x 78 x 103mm [1.22 x 3.07 x 4.06 inches] (without terminal block) (W x H x D) / 270g max (with cover : 310g max)							
	COOLING METHOD	Convection							

*1 Measured by 20MHz oscilloscope or Ripple-Noise meter(equivalent to KEISOKU-GIKEN :RM101).
 *2 Drift is the change in DC output for an eight hour period after a half-hour warm-up at 25°C.
 *3 Derating is required.
 *4 When two or more units are used,they may not comply with the harmonic attenuator. Please contact us for details.

*5 Please contact us about safety approvals for the model with option.
 *6 Please contact us about dynamic load and input response.
 *7 Please contact us about class C.
 * Parallel operation with other model is not possible.
 * Derating is required when operated with cover.
 * A sound may occur from power supply at peak loading.

Block diagram



External view

※ External size of option T,J,N,N1 and V is different from standard model and refer to 7 Option of instruction manual for details.



- ※ Tolerance : $\pm 1 [\pm 0.04]$
- ※ Weight : 270g max (with cover : 310g max)
- ※ PCB Material/thickness : CEM3 / 1.6mm [0.06]
- ※ Chassis material : Electric galvanizing steel board
- ※ Dimensions in mm, [] = inches
- ※ Mounting torque : $0.6N \cdot m (6.3kgf \cdot cm)$ max
- ※ Screw tightening torque : $M3 0.8N \cdot m (8.5kgf \cdot cm)$ max
- ※ Please connect safety ground to the unit in 2-M3 holes.

PBA50F

PB A 50 F -5 -□

① ② ③ ④ ⑤ ⑥

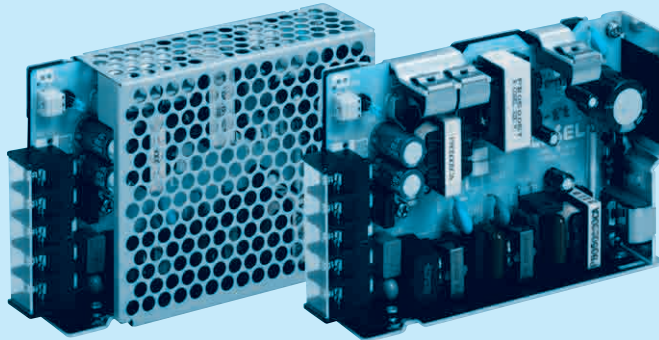

Recommended EMI/EMC Filter
NAC-06-472



High voltage pulse noise type : NAP series
Low leakage current type : NAM series
*The EMI/EMC Filter is recommended to connect with several devices.

- ① Series name
- ② Single output
- ③ Output wattage
- ④ Universal input
- ⑤ Output voltage
- ⑥ Optional *5
- C :with Coating
- G :Low leakage current (0.15mA max / ACIN 240V)
- E :Low leakage current and EMI class A (0.5mA max / ACIN 240V)
- T :Vertical terminal block
- J :Connector type
- R :with Remote ON/OFF
- N :with Cover (Only 24V UL508 is acquired)
- Nt :with DIN rail and Cover
- V :Output voltage setting potentiometer externaly

Cover is optional

MODEL	PBA50F-3R3	PBA50F-5	PBA50F-9	PBA50F-12	PBA50F-15	PBA50F-24	PBA50F-36	PBA50F-48
MAX OUTPUT WATTAGE[W]	33	50	50.4	51.6	52.5	52.8	50.4	52.8
DC OUTPUT	3.3V 10A	5V 10A	9V 5.6A	12V 4.3A	15V 3.5A	24V 2.2A	36V 1.4A	48V 1.1A

SPECIFICATIONS

MODEL	PBA50F-3R3	PBA50F-5	PBA50F-9	PBA50F-12	PBA50F-15	PBA50F-24	PBA50F-36	PBA50F-48
VOLTAGE[V]	AC85 - 264 1 φ or DC120 - 370 (AC50 or DC70 Please refer to the instruction manual 2.1 Input voltage *4)							
CURRENT[A]	ACIN 100V	0.5typ	0.7typ					
	ACIN 200V	0.3typ	0.4typ					
FREQUENCY[Hz]	50/60 (47 - 63)							
EFFICIENCY[%]	ACIN 100V	75typ	80typ	79typ	80typ	81typ	82typ	83typ
	ACIN 200V	76typ	82typ	81typ	82typ	83typ	84typ	85typ
POWER FACTOR(10=100%)	ACIN 100V	0.98typ	0.99typ					
	ACIN 200V	0.87typ	0.93typ					
INRUSH CURRENT[A]	ACIN 100V	15typ (10=100%) (At cold start)						
	ACIN 200V	30typ (10=100%) (At cold start)						
LEAKAGE CURRENT[mA]	0.4/0.75max (ACIN 100V/240V 60Hz, 10=100%, According to IEC60950-1,DENAN)							
VOLTAGE[V]	3.3	5	9	12	15	24	36	48
CURRENT[A]	10	10	5.6	4.3	3.5	2.2	1.4	1.1
LINE REGULATION[mV]	20max	20max	36max	48max	60max	96max	144max	192max
LOAD REGULATION[mV]	40max	40max	100max	100max	120max	150max	240max	240max
RIPPLE[mVp-p]	0 to +50°C *1	80max	80max	120max	120max	120max	120max	150max
	-10 - 0°C *1	140max	140max	160max	160max	160max	160max	200max
RIPPLE NOISE[mVp-p]	0 to +50°C *1	120max	120max	150max	150max	150max	150max	250max
	-10 - 0°C *1	160max	160max	180max	180max	180max	180max	300max
TEMPERATURE REGULATION[mV]	0 to +50°C	50max	50max	90max	120max	150max	240max	360max
	-10 to +50°C	60max	60max	120max	150max	180max	290max	450max
DRIFT[mV]	*2	20max	20max	36max	48max	60max	96max	144max
START-UP TIME[ms]	350typ (ACIN 100V, 10=100%)							
HOLD-UP TIME[ms]	20typ (ACIN 100V, 10=100%)							
OUTPUT VOLTAGE ADJUSTMENT RANGE[V]	2.85 - 3.63	4.00 - 5.50	7.50 - 10.0	10.0 - 13.2	13.2 - 18.0	19.2 - 27.0	28.8 - 39.6	39.0 - 53.0
OUTPUT VOLTAGE SETTING[V]	3.30 - 3.40	5.00 - 5.15	9.00 - 9.36	12.00 - 12.48	15.00 - 15.60	24.00 - 24.96	35.00 - 37.44	48.00 - 49.92
OVERCURRENT PROTECTION	Works over 105% of rated current and recovers automatically							
OVERVOLTAGE PROTECTION[V]	4.00 - 5.25	5.75 - 7.00	11.5 - 14.0	15.0 - 18.0	20.0 - 25.0	30.0 - 37.0	43.0 - 50.0	58.0 - 65.0
OPERATING INDICATION	LED (Green)							
REMOTE ON/OFF	Optional (Required external power source)							
INPUT-OUTPUT · RC	*3	AC3.000V 1minute, Cutoff current = 10mA, DC500V 50MΩmin (At Room Temperature)						
INPUT-FG		AC2.000V 1minute, Cutoff current = 10mA, DC500V 50MΩmin (At Room Temperature)						
OUTPUT · RC-FG	*3	AC500V 1minute, Cutoff current = 100mA, DC500V 50MΩmin (At Room Temperature)						
OPERATING TEMP.,HUMID.AND ALTITUDE	-10 to +71°C (Required Derating), 20 - 90%RH (Non condensing) 3,000m (10,000feet) max							
STORAGE TEMP.,HUMID.AND ALTITUDE	-20 to +75°C, 20 - 90%RH (Non condensing) 9,000m (30,000feet) max							
VIBRATION	10 - 55Hz, 19.6m/s ² (2G), 3minutes period, 60minutes each along X, Y and Z axis							
IMPACT	196.1m/s ² (20G), 11ms, once each X, Y and Z axis							
AGENCY APPROVALS (At only AC input)	UL60950-1, C-UL(CSA60950-1), EN60950-1, EN50178 Complies with DEN-AN							
CONDUCTED NOISE	Complies with FCC Part15 classB, VCCI-B, CISPR22-B, EN55011-B, EN55022-B							
HARMONIC ATTENUATOR	Complies with IEC61000-3-2 *6							
CASE SIZE/WEIGHT	31 x 82 x 120mm [1.22 x 3.23 x 4.72 inches] (without terminal block) (W x H x D) / 280g max (with cover : 325g max)							
COOLING METHOD	Convection							

*1 Measured by 20MHz oscilloscope or Ripple-Noise meter(equivalent to KEISOKU-GIKEN :RM101).
 *2 Drift is the change in DC output for an eight hour period after a half-hour warm-up at 25°C.
 *3 Applicable when Remote ON/OFF(optional) is added. RC is insulated with input, output and FG.
 *4 Derating is required.

*5 Please contact us about safety approvals for the model with option.
 *6 Please contact us about class C.
 * Parallel operation with other model is not possible.
 * Derating is required when operated with cover.
 * A sound may occur from power supply at peak loading.

Block diagram



External view

※ External size of option T,J,R,N,N1 and V is different from standard model and refer to 7 Option of instruction manual for details.



PBA75F

PB A 75 F -5 -□

① ② ③ ④ ⑤ ⑥

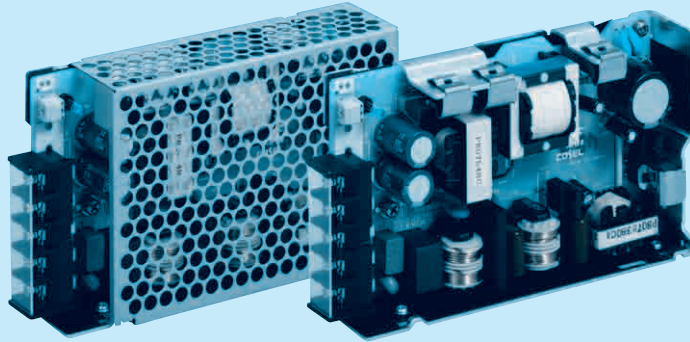

Recommended EMI/EMC Filter
NAC-06-472



High voltage pulse noise type : NAP series
Low leakage current type : NAM series
*The EMI/EMC Filter is recommended to connect with several devices.

- ① Series name
- ② Single output
- ③ Output wattage
- ④ Universal input
- ⑤ Output voltage
- ⑥ Optional *5
- C :with Coating
- G :Low leakage current (0.15mA max / ACIN 240V)
- E :Low leakage current and EMI class A (0.5mA max / ACIN 240V)
- T :Vertical terminal block
- J :Connector type
- R :with Remote ON/OFF
- N :with Cover (Only 24V UL508 is acquired)
- Nt :with DIN rail and Cover
- V :Output voltage setting potentiometer externaly

Cover is optional

MODEL	PBA75F-3R3	PBA75F-5	PBA75F-9	PBA75F-12	PBA75F-15	PBA75F-24	PBA75F-36	PBA75F-48
MAX OUTPUT WATTAGE[W]	49.5	75	75.6	75.6	75	76.8	75.6	76.8
DC OUTPUT	3.3V 15A	5V 15A	9V 8.4A	12V 6.3A	15V 5A	24V 3.2A	36V 2.1A	48V 1.6A

SPECIFICATIONS

MODEL	PBA75F-3R3	PBA75F-5	PBA75F-9	PBA75F-12	PBA75F-15	PBA75F-24	PBA75F-36	PBA75F-48
VOLTAGE[V]	AC85 - 264 1 φ or DC120 - 370 (AC50 or DC70 Please refer to the instruction manual 2.1 Input voltage *4)							
CURRENT[A]	ACIN 100V	0.7typ	1.0typ					
	ACIN 200V	0.4typ	0.5typ					
FREQUENCY[Hz]	50/60 (47 - 63)							
EFFICIENCY[%]	ACIN 100V	77typ	81typ	80typ	81typ	82typ	83typ	84typ
	ACIN 200V	78typ	83typ	82typ	83typ	84typ	85typ	86typ
POWER FACTOR(Lo=100%)	ACIN 100V	0.98typ	0.99typ					
	ACIN 200V	0.87typ	0.93typ					
INRUSH CURRENT[A]	ACIN 100V	15typ (Io=100%) (At cold start)						
	ACIN 200V	30typ (Io=100%) (At cold start)						
LEAKAGE CURRENT[mA]	0.4/0.75max (ACIN 100V/240V 60Hz, Io=100%, According to IEC60950-1,DENAN)							
VOLTAGE[V]	3.3	5	9	12	15	24	36	48
CURRENT[A]	15	15	8.4	6.3	5	3.2	2.1	1.6
LINE REGULATION[mV]	20max	20max	36max	48max	60max	96max	144max	192max
LOAD REGULATION[mV]	40max	40max	100max	100max	120max	150max	240max	240max
RIPPLE[mVp-p]	0 to +50°C *1	80max	80max	120max	120max	120max	120max	150max
	-10 - 0°C *1	140max	140max	160max	160max	160max	160max	200max
RIPPLE NOISE[mVp-p]	0 to +50°C *1	120max	120max	150max	150max	150max	150max	250max
	-10 - 0°C *1	160max	160max	180max	180max	180max	180max	300max
TEMPERATURE REGULATION[mV]	0 to +50°C	50max	50max	90max	120max	150max	240max	360max
	-10 to +50°C	60max	60max	120max	150max	180max	290max	450max
DRIFT[mV]	*2	20max	20max	36max	48max	60max	96max	144max
START-UP TIME[ms]	350typ (ACIN 100V, Io=100%)							
HOLD-UP TIME[ms]	20typ (ACIN 100V, Io=100%)							
OUTPUT VOLTAGE ADJUSTMENT RANGE[V]	2.85 - 3.63	4.00 - 5.50	7.50 - 10.0	10.0 - 13.2	13.2 - 18.0	19.2 - 27.0	28.8 - 39.6	39.0 - 53.0
OUTPUT VOLTAGE SETTING[V]	3.30 - 3.40	5.00 - 5.15	9.00 - 9.36	12.00 - 12.48	15.00 - 15.60	24.00 - 24.96	36.00 - 37.44	48.00 - 49.92
OVERCURRENT PROTECTION	Works over 105% of rated current and recovers automatically							
OVERVOLTAGE PROTECTION[V]	4.00 - 5.25	5.75 - 7.00	11.5 - 14.0	15.0 - 18.0	20.0 - 25.0	30.0 - 37.0	43.0 - 50.0	58.0 - 65.0
OPERATING INDICATION	LED (Green)							
REMOTE ON/OFF	Optional (Required external power source)							
INPUT-OUTPUT · RC	*3	AC3.000V 1minute, Cutoff current = 10mA, DC500V 50MΩmin (At Room Temperature)						
INPUT-FG	AC2.000V 1minute, Cutoff current = 10mA, DC500V 50MΩmin (At Room Temperature)							
OUTPUT · RC-FG	*3	AC500V 1minute, Cutoff current = 100mA, DC500V 50MΩmin (At Room Temperature)						
OPERATING TEMP.,HUMID.AND ALTITUDE	-10 to +71°C (Required Derating), 20 - 90%RH (Non condensing) 3,000m (10,000feet) max							
STORAGE TEMP.,HUMID.AND ALTITUDE	-20 to +75°C, 20 - 90%RH (Non condensing) 9,000m (30,000feet) max							
VIBRATION	10 - 55Hz, 19.6m/s ² (2G), 3minutes period, 60minutes each along X, Y and Z axis							
IMPACT	196.1m/s ² (20G), 11ms, once each X, Y and Z axis							
AGENCY APPROVALS (At only AC input)	UL60950-1, C-UL(CSA60950-1), EN60950-1, EN50178 Complies with DEN-AN							
CONDUCTED NOISE	Complies with FCC Part15 classB, VCCI-B, CISPR22-B, EN55011-B, EN55022-B							
HARMONIC ATTENUATOR	Complies with IEC61000-3-2 *6							
CASE SIZE/WEIGHT	32×82×135mm [1.26×3.23×5.31 inches] (without terminal block) (W×H×D) / 350g max (with cover : 400g max)							
COOLING METHOD	Convection							

*1 Measured by 20MHz oscilloscope or Ripple-Noise meter(equivalent to KEISOKU-GIKEN :RM101).
 *2 Drift is the change in DC output for an eight hour period after a half-hour warm-up at 25°C.
 *3 Applicable when Remote ON/OFF(optional) is added. RC is insulated with input, output and FG.
 *4 Derating is required.

*5 Please contact us about safety approvals for the model with option.
 *6 Please contact us about class C.
 * Parallel operation with other model is not possible.
 * Derating is required when operated with cover.
 * A sound may occur from power supply at peak loading.

Block diagram



External view

※ External size of option T,J,R,N,N1 and V is different from standard model and refer to 7 Option of instruction manual for details.



Connector type
CN3 Option (Mfr : J.S.T.)

Pin No.	Contents
1	RC(+)
2	RC(-)

Barrier strip type
Model B2B-XH-A
Mating Connector (Terminal)
XHP-2
(BXH-001T-P0.6
or SXH-001T-P0.6)

- ※ Tolerance : ±1 [±0.04]
- ※ Weight : 350g max (with cover : 400g max)
- ※ PCB Material/thickness : CEM3 / 1.6mm [0.06]
- ※ Chassis material : Aluminum
- ※ Dimensions in mm, [] = inches
- ※ Mounting torque : 0.49N • m(5kgf • cm)max
- ※ Screw tightening torque : M3 0.8N • m(8.5kgf • cm)max
- ※ Please connect safety ground to the unit in 2-M3 holes.

PBA100F

PB A 100 F -5 -□

① ② ③ ④ ⑤ ⑥

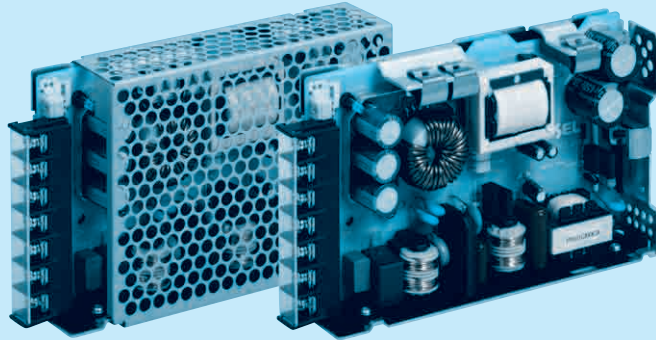
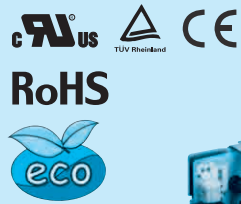

Recommended EMI/EMC Filter
NAC-06-472



High voltage pulse noise type : NAP series
Low leakage current type : NAM series
*The EMI/EMC Filter is recommended to connect with several devices.

- ① Series name
- ② Single output
- ③ Output wattage
- ④ Universal input
- ⑤ Output voltage
- ⑥ Optional *5
- C :with Coating
- G :Low leakage current (0.15mA max / ACIN 240V)
- E :Low leakage current and EMI class A (0.5mA max / ACIN 240V)
- T :Vertical terminal block
- J :Connector type (Only -12,-15,-24,-36,-48)
- R :with Remote ON/OFF
- N :with Cover (Only 24V UL508 is acquired)
- N1 :with DIN rail and Cover
- V :Output voltage setting potentiometer externaly

Cover is optional

MODEL	PBA100F-3R3	PBA100F-5	PBA100F-9	PBA100F-12	PBA100F-15	PBA100F-24	PBA100F-36	PBA100F-48
MAX OUTPUT WATTAGE[W]	66	100	94.5	102	105	108	100.8	100.8
DC OUTPUT	3.3V 20A	5V 20A	9V 10.5A	12V 8.5A	15V 7A	24V 4.5A	36V 2.8A	48V 2.1A

SPECIFICATIONS

	MODEL	PBA100F-3R3	PBA100F-5	PBA100F-9	PBA100F-12	PBA100F-15	PBA100F-24	PBA100F-36	PBA100F-48	
INPUT	VOLTAGE[V]	AC85 - 264 1 φ or DC120 - 370 (AC50 or DC70 Please refer to the instruction manual 2.1 Input voltage *4)								
	CURRENT[A]	ACIN 100V	0.9typ	1.3typ						
		ACIN 200V	0.5typ	0.7typ						
	FREQUENCY[Hz]	50/60 (47 - 63)								
	EFFICIENCY[%]	ACIN 100V	77typ	82typ	80typ	81typ	83typ	84typ	84typ	84typ
		ACIN 200V	79typ	84typ	82typ	83typ	86typ	86typ	86typ	86typ
	POWER FACTOR(lo=100%)	ACIN 100V	0.98typ	0.99typ						
		ACIN 200V	0.87typ	0.93typ						
	INRUSH CURRENT[A]	ACIN 100V	20typ (lo=100%) (At cold start)							
		ACIN 200V	40typ (lo=100%) (At cold start)							
LEAKAGE CURRENT[mA]	0.4/0.75max (ACIN 100V/240V 60Hz, lo=100%, According to IEC60950-1.DENAN)									
OUTPUT	VOLTAGE[V]	3.3	5	9	12	15	24	36	48	
	CURRENT[A]	20	20	10.5	8.5	7	4.5	2.8	2.1	
	LINE REGULATION[mV]	20max	20max	36max	48max	60max	96max	144max	192max	
	LOAD REGULATION[mV]	40max	40max	100max	100max	120max	150max	240max	240max	
	RIPPLE[mVp-p]	0 to +50°C *1	80max	80max	120max	120max	120max	120max	150max	150max
		-10 - 0°C *1	140max	140max	160max	160max	160max	160max	200max	200max
	RIPPLE NOISE[mVp-p]	0 to +50°C *1	120max	120max	150max	150max	150max	150max	250max	250max
		-10 - 0°C *1	160max	160max	180max	180max	180max	180max	300max	300max
	TEMPERATURE REGULATION[mV]	0 to +50°C	50max	50max	90max	120max	150max	240max	360max	480max
		-10 to +50°C	60max	60max	120max	150max	180max	290max	450max	600max
	DRIFT[mV]	*2	20max	20max	36max	48max	60max	96max	144max	192max
	START-UP TIME[ms]	350typ(ACIN 100V, lo=100%)								
	HOLD-UP TIME[ms]	20typ (ACIN 100V, lo=100%)								
OUTPUT VOLTAGE ADJUSTMENT RANGE[V]	2.85 - 3.63	4.00 - 5.50	7.50 - 10.0	10.0 - 13.2	13.2 - 18.0	19.2 - 27.0	28.8 - 39.6	39.0 - 53.0		
OUTPUT VOLTAGE SETTING[V]	3.20 - 3.40	5.00 - 5.15	9.00 - 9.36	12.00 - 12.48	15.00 - 15.60	24.00 - 24.96	36.00 - 37.44	48.00 - 49.92		
PROTECTION CIRCUIT AND OTHERS	OVERCURRENT PROTECTION	Works over 105% of rated current and recovers automatically								
	OVERVOLTAGE PROTECTION[V]	4.00 - 5.25	5.75 - 7.00	11.5 - 14.0	15.0 - 18.0	20.0 - 25.0	30.0 - 37.0	43.0 - 50.0	58.0 - 65.0	
	OPERATING INDICATION	LED (Green)								
	REMOTE SENSING	Optional (Only -3R3, -5 Option -K)								
ISOLATION	REMOTE ON/OFF	Optional (Required external power source)								
	INPUT-OUTPUT · RC	*3	AC3,000V 1minute, Cutoff current = 10mA, DC500V 50MΩmin (At Room Temperature)							
	INPUT-FG	AC2,000V 1minute, Cutoff current = 10mA, DC500V 50MΩmin (At Room Temperature)								
ENVIRONMENT	OUTPUT · RC-FG	*3	AC500V 1minute, Cutoff current = 100mA, DC500V 50MΩmin (At Room Temperature)							
	OPERATING TEMP.,HUMID.AND ALTITUDE	-10 to +71°C (Required Derating), 20 - 90%RH (Non condensing) 3,000m (10,000feet) max								
	STORAGE TEMP.,HUMID.AND ALTITUDE	-20 to +75°C, 20 - 90%RH (Non condensing) 9,000m (30,000feet) max								
SAFETY AND NOISE REGULATIONS	VIBRATION	10 - 55Hz, 19.6m/s ² (2G), 3minutes period, 60minutes each along X, Y and Z axis								
	IMPACT	196.1m/s ² (20G), 11ms, once each X, Y and Z axis								
	AGENCY APPROVALS (At only AC input)	UL60950-1, C-UL(CSA60950-1), EN60950-1, EN50178 Complies with DEN-AN								
OTHERS	CONDUCTED NOISE	Complies with FCC Part15 classB, VCCI-B, CISPR22-B, EN55011-B, EN55022-B								
	HARMONIC ATTENUATOR	Complies with IEC61000-3-2 *6								
OTHERS	CASE SIZE/WEIGHT	32×93×147mm [1.26×3.66×5.79 inches] (without terminal block) (W×H×D) / 440g max (with cover : 500g max)								
	COOLING METHOD	Convection								

*1 Measured by 20MHz oscilloscope or Ripple-Noise meter(equivalent to KEISOKU-GIKEN :RM101).
 *2 Drift is the change in DC output for an eight hour period after a half-hour warm-up at 25°C.
 *3 Applicable when Remote ON/OFF(optional) is added. RC is insulated with input, output and FG.
 *4 Derating is required.

*5 Please contact us about safety approvals for the model with option.
 *6 Please contact us about class C.
 * Parallel operation with other model is not possible.
 * Derating is required when operated with cover.
 * A sound may occur from power supply at peak loading.

Block diagram



External view

※ External size of option T,J,R,N,N1,V and K is different from standard model and refer to 7 Option of instruction manual for details.



Connector type	
CN3 Option (Mfr : J.S.T.)	
Pin No.	Contents
1	RC(+)
2	RC(-)

Barrier strip type	
Model B2B-XH-A	
Mating Connector (Terminal)	
XHP-2	
(BXH-001T-P0.6	
or SXH-001T-P0.6)	

- ※ Tolerance : ± 1 [±0.04]
- ※ Weight : 440g max (with cover : 500g max)
- ※ PCB Material/thickness : CEM3 / 1.6mm [0.06]
- ※ Chassis material : Aluminum
- ※ Dimensions in mm, [] = inches
- ※ Mounting torque : 0.49N • m (5kgf • cm) max
- ※ Mounting torque : M4:1.6N • m (16.9kgf • cm) max
- ※ Please connect safety ground to FG terminal on the unit.

PBA150F

PB A 150 F -5 -□

① ② ③ ④ ⑤ ⑥

Recommended EMI/EMC Filter
NAC-06-472



High voltage pulse noise type : NAP series
Low leakage current type : NAM series
*The EMI/EMC Filter is recommended to connect with several devices.

- ① Series name
- ② Single output
- ③ Output wattage
- ④ Universal input
- ⑤ Output voltage
- ⑥ Optional *5
- C :with Coating
- G :Low leakage current (0.15mA max / ACIN 240V)
- E :Low leakage current and EMI class A (0.5mA max / ACIN 240V)
- T :Vertical terminal block
- J :Connector type (Only -12,-15,-24,-36,-48)
- R :with Remote ON/OFF
- N :with Cover (Only 24V UL508 is acquired)
- N1 :with DIN rail and Cover
- V :Output voltage setting potentiometer externaly

Cover is optional



MODEL	PBA150F-3R3	PBA150F-5	PBA150F-9	PBA150F-12	PBA150F-15	PBA150F-24	PBA150F-36	PBA150F-48
MAX OUTPUT WATTAGE[W]	99	150	150.3	156	150	156	154.8	158.4
DC OUTPUT	3.3V 30A	5V 30A	9V 16.7A	12V 13A	15V 10A	24V 6.5A	36V 4.3A	48V 3.3A

SPECIFICATIONS

	MODEL	PBA150F-3R3	PBA150F-5	PBA150F-9	PBA150F-12	PBA150F-15	PBA150F-24	PBA150F-36	PBA150F-48	
INPUT	VOLTAGE[V]	AC85 - 264 1 φ or DC120 - 370 (AC50 or DC70 Please refer to the instruction manual 2.1 Input voltage *4)								
	CURRENT[A]	ACIN 100V	1.3typ	2.0typ						
		ACIN 200V	0.7typ	1.0typ						
	FREQUENCY[Hz]	50/60 (47 - 63)								
	EFFICIENCY[%]	ACIN 100V	80typ	83typ	82typ	83typ	84typ	85typ	85typ	85typ
		ACIN 200V	82typ	86typ	85typ	86typ	87typ	88typ	88typ	88typ
	POWER FACTOR(lo=100%)	ACIN 100V	0.98typ	0.99typ						
		ACIN 200V	0.87typ	0.93typ						
	INRUSH CURRENT[A]	ACIN 100V	20typ (lo=100%) (At cold start)							
		ACIN 200V	40typ (lo=100%) (At cold start)							
LEAKAGE CURRENT[mA]	0.4/0.75max (ACIN 100V/240V 60Hz, lo=100%, According to IEC60950-1.DENAN)									
OUTPUT	VOLTAGE[V]	3.3	5	9	12	15	24	36	48	
	CURRENT[A]	30	30	16.7	13	10	6.5	4.3	3.3	
	LINE REGULATION[mV]	20max	20max	36max	48max	60max	96max	144max	192max	
	LOAD REGULATION[mV]	40max	40max	100max	100max	120max	150max	240max	240max	
	RIPPLE[mVp-p]	0 to +50°C *1	80max	80max	120max	120max	120max	120max	150max	150max
		-10 - 0°C *1	140max	140max	160max	160max	160max	160max	200max	200max
	RIPPLE NOISE[mVp-p]	0 to +50°C *1	120max	120max	150max	150max	150max	150max	250max	250max
		-10 - 0°C *1	160max	160max	180max	180max	180max	180max	300max	300max
	TEMPERATURE REGULATION[mV]	0 to +50°C	50max	50max	90max	120max	150max	240max	360max	480max
		-10 to +50°C	60max	60max	120max	150max	180max	290max	450max	600max
	DRIFT[mV]	*2	20max	20max	36max	48max	60max	96max	144max	192max
	START-UP TIME[ms]	350typ(ACIN 100V, lo=100%)								
	HOLD-UP TIME[ms]	20typ (ACIN 100V, lo=100%)								
	OUTPUT VOLTAGE ADJUSTMENT RANGE[V]	2.85 - 3.63	4.00 - 5.50	7.50 - 10.0	10.0 - 13.2	13.2 - 18.0	19.2 - 27.0	28.8 - 39.6	39.0 - 53.0	
OUTPUT VOLTAGE SETTING[V]	3.30 - 3.40	5.00 - 5.15	9.00 - 9.36	12.00 - 12.48	15.00 - 15.60	24.00 - 24.96	36.00 - 37.44	48.00 - 49.92		
PROTECTION CIRCUIT AND OTHERS	OVERCURRENT PROTECTION	Works over 105% of rated current and recovers automatically								
	OVERVOLTAGE PROTECTION[V]	4.00 - 5.25	5.75 - 7.00	11.5 - 14.0	15.0 - 18.0	20.0 - 25.0	30.0 - 37.0	43.0 - 50.0	58.0 - 65.0	
	OPERATING INDICATION	LED (Green)								
	REMOTE SENSING	Optional (Only -3R3, -5 Option -K)								
ISOLATION	REMOTE ON/OFF	Optional (Required external power source)								
	INPUT-OUTPUT · RC	*3	AC3.000V 1minute, Cutoff current = 10mA, DC500V 50MΩmin (At Room Temperature)							
	INPUT-FG	*3	AC2.000V 1minute, Cutoff current = 10mA, DC500V 50MΩmin (At Room Temperature)							
ENVIRONMENT	OUTPUT · RC-FG	*3	AC500V 1minute, Cutoff current = 100mA, DC500V 50MΩmin (At Room Temperature)							
	OPERATING TEMP.,HUMID.AND ALTITUDE	-10 to +71°C (Required Derating), 20 - 90%RH (Non condensing) 3,000m (10,000feet) max								
	STORAGE TEMP.,HUMID.AND ALTITUDE	-20 to +75°C, 20 - 90%RH (Non condensing) 9,000m (30,000feet) max								
	VIBRATION	10 - 55Hz, 19.6m/s ² (2G), 3minutes period, 60minutes each along X, Y and Z axis								
SAFETY AND NOISE REGULATIONS	IMPACT	196.1m/s ² (20G), 11ms, once each X, Y and Z axis								
	AGENCY APPROVALS (At only AC input)	UL60950-1, C-UL(CSA60950-1), EN60950-1, EN50178 Complies with DEN-AN								
	CONDUCTED NOISE	Complies with FCC Part15 classB, VCCI-B, CISPR22-B, EN55011-B, EN55022-B								
	HARMONIC ATTENUATOR	Complies with IEC61000-3-2 *6								
OTHERS	CASE SIZE/WEIGHT	34×93×168mm [1.34×3.66×6.61 inches] (without terminal block) (W×H×D) / 560g max (with cover : 630g max)								
	COOLING METHOD	Convection								

*1 Measured by 20MHz oscilloscope or Ripple-Noise meter(equivalent to KEISOKU-GIKEN :RM101).
 *2 Drift is the change in DC output for an eight hour period after a half-hour warm-up at 25°C.
 *3 Applicable when Remote ON/OFF(optional) is added. RC is insulated with input, output and FG.
 *4 Derating is required.

*5 Please contact us about safety approvals for the model with option.
 *6 Please contact us about class C.
 * Parallel operation with other model is not possible.
 * Derating is required when operated with cover.
 * A sound may occur from power supply at peak loading.

Block diagram

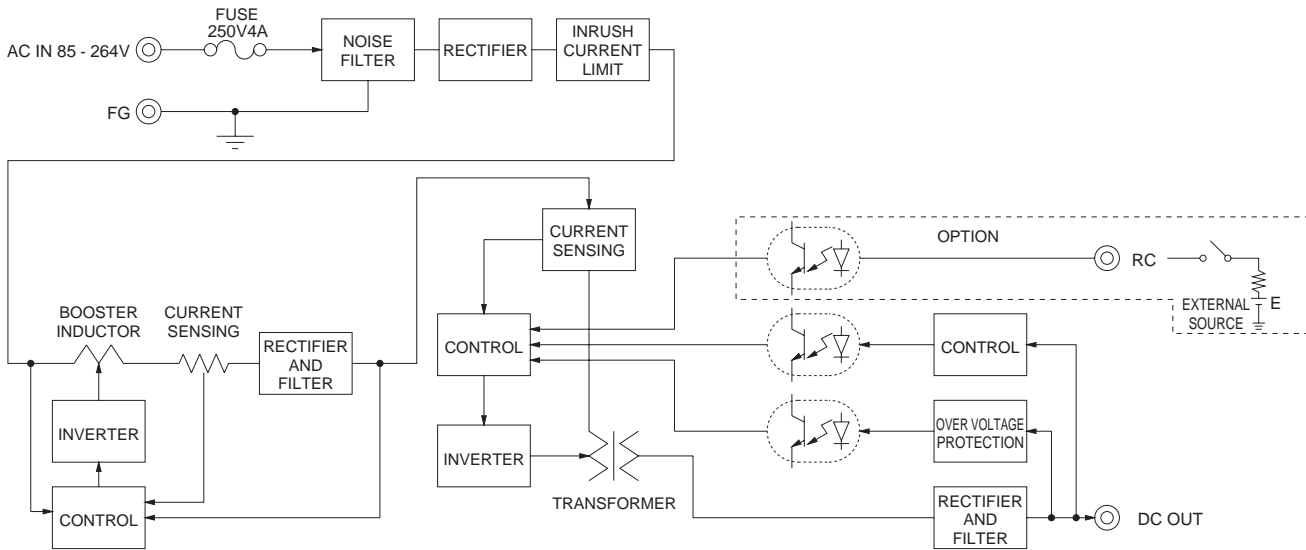

External view

※ External size of option T,J,R,N,N1,V and K is different from standard model and refer to 7 Option of instruction manual for details.

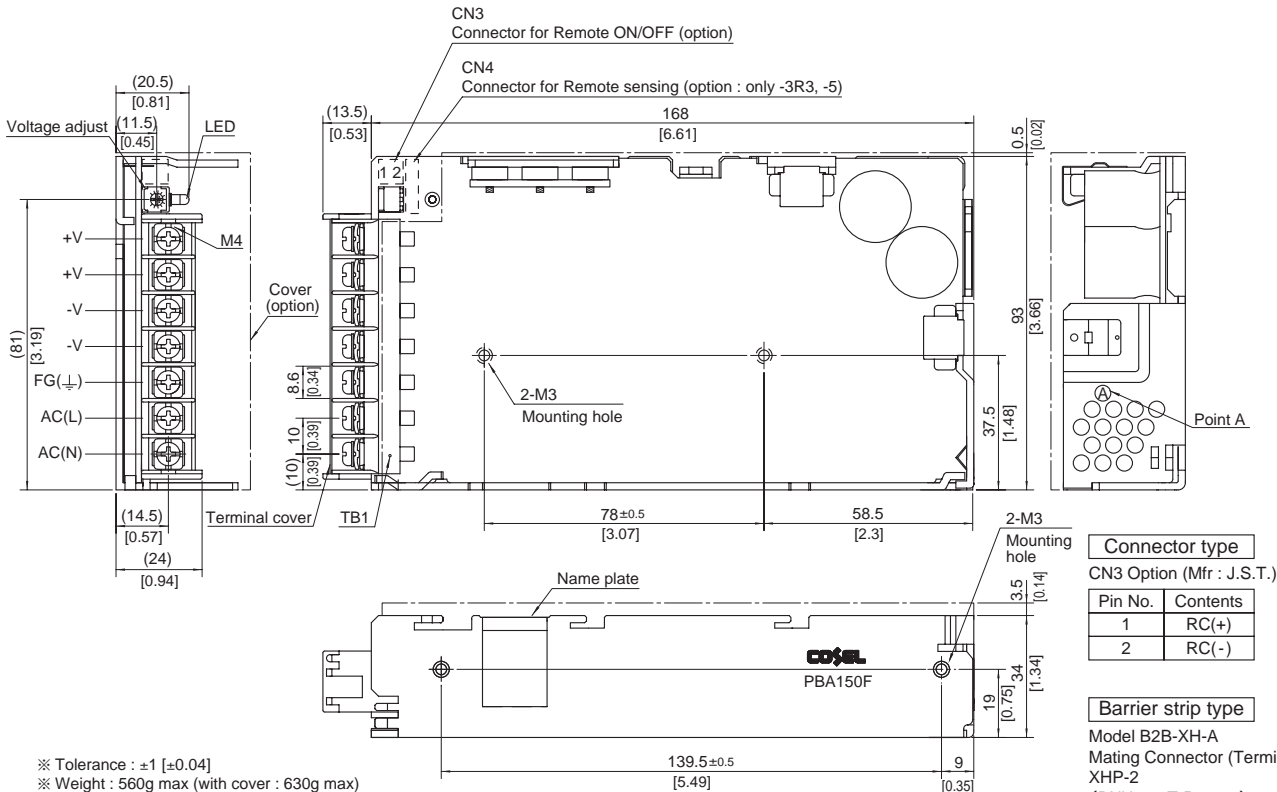

- ※ Tolerance : ±1 [±0.04]
- ※ Weight : 560g max (with cover : 630g max)
- ※ PCB Material/thickness : CEM3 / 1.6mm [0.06]
- ※ Chassis material : Aluminum
- ※ Dimensions in mm, [] = inches
- ※ Mounting torque : 0.49N • m (5kgf • cm)max
- ※ Mounting torque : M4:1.6N • m (16.9kgf • cm)max
- ※ Keep drawing current per pin below 20A for TB1.

Mouser Electronics

Authorized Distributor

Click to View Pricing, Inventory, Delivery & Lifecycle Information:

Cosel:

[N-PBA15-J/T](#) [F-PBA100-2](#) [N-PBA10-J/T](#) [N-PBA50](#) [F-PBA50-2](#) [N-PBA75-J/T](#) [F-PBA30-1](#) [F-PPBA30-1](#) [N-PBA10](#)
[F-PPBA100-1](#) [F-PBA75-1](#) [F-PBA150-2](#) [F-PBA10-1](#) [N-PBA50-J/T](#) [N-PBA15](#) [N-PBA100](#) [F-PBA30-2](#) [N-PBA30](#) [N-](#)
[PBA100-J/T](#) [N-PBA30-J/T](#) [N-PBA75](#) [F-PBA75-2](#) [F-PBA15-1](#) [N-PBA150](#) [F-PPBA75-1](#) [F-PBA15-2](#) [F-PBA100-1](#) [F-](#)
[PPBA50-1](#) [F-PBA10-2](#) [F-PBA150-1](#) [F-PPBA15-1](#) [F-PBA50-1](#) [N-PBA150-J/T](#) [PBA100F-5-T](#) [PBA100F-5-C](#) [PBA30F-](#)
[24-JVN](#) [PBA100F-3R3-CMN](#) [PBA100F-15-TN](#) [PBA100F-36-GJ](#) [PBA30F-9-JN](#) [PBA30F-48](#) [PBA75F-5-T](#) [PBA75F-](#)
[15-RVN](#) [PBA15F-3R3-N](#) [PBA75F-3R3-EN](#) [PBA75F-24-J](#) [PBA75F-48-CT](#) [PBA150F-24-RN1](#) [PBA50F-15-GN](#)
[PBA50F-36-R](#) [PBA150F-15-RN](#) [PBA10F-24-EN](#) [PBA150F-5-CEN](#) [PBA150F-12-CN](#) [PBA15F-5](#) [PBA50F-12-R](#)
[PBA50F-5-E](#) [PBA75F-12-CR](#) [PBA75F-12-RV](#) [PBA50F-24-JR](#) [PBA150F-36-N1](#) [PBA15F-5-TN](#) [PBA100F-3R3-T](#)
[PBA100F-12-RT](#) [PBA150F-15-CN1](#) [PBA50F-24-CEN](#) [PBA30F-48-J](#) [PBA10F-5-N](#) [PBA100F-9-T](#) [PBA100F-12-TN](#)
[PBA150F-48-D40N](#) [PBA150F-48-RT](#) [PBA30F-24-CT](#) [PBA15F-3R3-E](#) [PBA150F-24-C](#) [PBA15F-48-GN](#) [PBA150F-24-](#)
[CTN](#) [PBA150F-5-T](#) [PBA75F-15-CRN](#) [PBA150F-5-VN](#) [PBA100F-36-GTN](#) [PBA100F-12-CN1](#) [PBA50F-15](#) [PBA100F-](#)
[24-R](#) [PBA150F-24-GTN](#) [PBA10F-24-J](#) [PBA50F-9-TN](#) [PBA30F-5-GN](#) [PBA50F-48-R](#) [PBA75F-36-C](#) [PBA30F-12-V](#)
[PBA50F-5-R](#) [PBA150F-3R3-T](#) [PBA150F-24-JN1](#) [PBA30F-3R3-CN](#) [PBA75F-36-T](#) [PBA150F-3R3-GR](#) [PBA150F-24-E](#)
[PBA100F-24-CN1](#) [PBA100F-24-RT](#)



Компания «ЭлектроПласт» предлагает заключение долгосрочных отношений при поставках импортных электронных компонентов на взаимовыгодных условиях!

Наши преимущества:

- Оперативные поставки широкого спектра электронных компонентов отечественного и импортного производства напрямую от производителей и с крупнейших мировых складов;
- Поставка более 17-ти миллионов наименований электронных компонентов;
- Поставка сложных, дефицитных, либо снятых с производства позиций;
- Оперативные сроки поставки под заказ (от 5 рабочих дней);
- Экспресс доставка в любую точку России;
- Техническая поддержка проекта, помощь в подборе аналогов, поставка прототипов;
- Система менеджмента качества сертифицирована по Международному стандарту ISO 9001;
- Лицензия ФСБ на осуществление работ с использованием сведений, составляющих государственную тайну;
- Поставка специализированных компонентов (Xilinx, Altera, Analog Devices, Intersil, Interpoint, Microsemi, Aeroflex, Peregrine, Syfer, Eurofarad, Texas Instrument, Miteq, Cobham, E2V, MA-COM, Hittite, Mini-Circuits, General Dynamics и др.);

Помимо этого, одним из направлений компании «ЭлектроПласт» является направление «Источники питания». Мы предлагаем Вам помощь Конструкторского отдела:

- Подбор оптимального решения, техническое обоснование при выборе компонента;
- Подбор аналогов;
- Консультации по применению компонента;
- Поставка образцов и прототипов;
- Техническая поддержка проекта;
- Защита от снятия компонента с производства.



Как с нами связаться

Телефон: 8 (812) 309 58 32 (многоканальный)

Факс: 8 (812) 320-02-42

Электронная почта: org@eplast1.ru

Адрес: 198099, г. Санкт-Петербург, ул. Калинина, дом 2, корпус 4, литера А.