

# HDSM-431x/433x

0.39" (10.0mm)  
Single digit surface mount LED display



## Data Sheet

### Description

This is 0.39" (10.0mm) height single digit display. This device utilizes AlInGaP / GaAs chips. This device is with top surface gray and white segments.

### Features

- 0.39" digit height
- Low current operation
- Excellent characters appearance
- Available in CA and CC
- 1000 pieces per reel
- Moisture Sensitivity Level: Level 3
- RoHS compliant

### Ordering Information

Red	Green	Yellow	Orange	Description
HDSM-431C	HDSM-431H	HDSM-431F	HDSM-431L	Common Anode, Right Hand Decimal
HDSM-433C	HDSM-433H	HDSM-433F	HDSM-433L	Common Cathode, Right Hand Decimal

### Package Dimensions

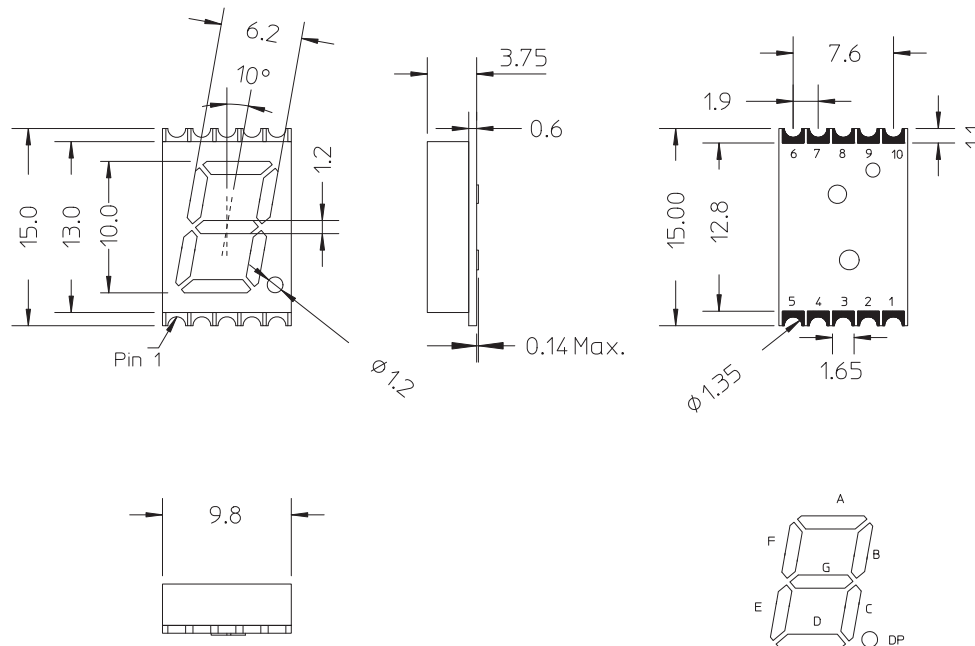

#### Note:

1. All dimensions are in millimeters.
2. Tolerance are +/- 0.25mm unless otherwise specified.

### Pin Connection (Common Anode)

PIN No	Connection
1	Cathode E
2	Cathode D
3	Common Anode
4	Cathode C
5	Cathode DP
6	Cathode B
7	Cathode A
8	Common Anode
9	Cathode F
10	Cathode G

### Pin Connection (Common Cathode)

PIN No	Connection
1	Anode E
2	Anode D
3	Common Cathode
4	Anode C
5	Anode DP
6	Anode B
7	Anode A
8	Common Cathode
9	Anode F
10	Anode G

### Internal Circuit Diagram (Common Anode)

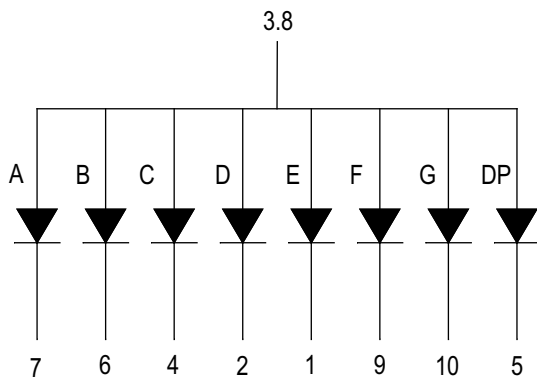

### Internal Circuit Diagram (Common Cathode)

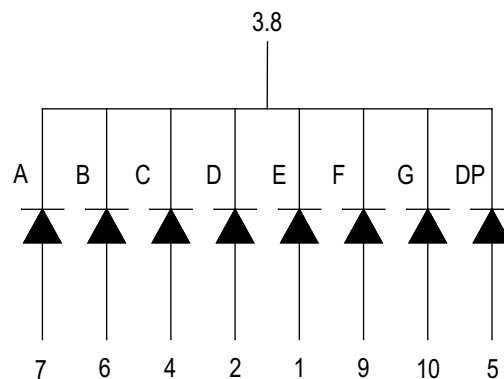

### Absolute Maximum Ratings @ $T_A=25^\circ$

Parameter	Green/Yellow/Red/Orange	Unit
Power Dissipation Per Segment	65	mW
Peak Forward Current Per Segment (1/10 Duty Cycle, .01ms pulse width)	100	mA
Continuous Forward Current Per Segment Derating Linearly From 25°C Per Segment	25 0.25	mA mA/°C
Reverse Voltage Per Segment	5	V
Operating Temperature Range	-40°C to +105°C	
Storage Temperature Range	-40°C to +105°C	

## Electrical / Optical Characteristics @ T<sub>A</sub>=25°C

### Green

Parameters	Symbol	Min	Typ	Max	Unit	Test Condition
Average Luminous Intensity	I <sub>V</sub>	5.4	9	-	Mcd	I <sub>F</sub> = 10mA
Emissions Wavelength	λ <sub>p</sub> /λ <sub>d</sub>	-	572/571	-	Nm	I <sub>F</sub> = 20mA
Spectral Line Half-Width	Δλ	-	20	-	Nm	I <sub>F</sub> = 20mA
Forward Voltage, Per Segment	V <sub>F</sub>	-	2.1	2.6	V	I <sub>F</sub> = 20mA
Reverse Current, Per Segment	I <sub>R</sub>	-	-	100	μA	V <sub>R</sub> = 5V
Luminous Intensity Matching Ratio	I <sub>V-M</sub>	-	-	2:1	-	I <sub>F</sub> = 10mA

### Yellow

Parameters	Symbol	Min	Typ	Max	Unit	Test Condition
Average Luminous Intensity	I <sub>V</sub>	8.6	15	-	Mcd	I <sub>F</sub> = 10mA
Emissions Wavelength	λ <sub>p</sub> /λ <sub>d</sub>	-	591/589	-	Nm	I <sub>F</sub> = 20mA
Spectral Line Half-Width	Δλ	-	15	-	Nm	I <sub>F</sub> = 20mA
Forward Voltage, Per Segment	V <sub>F</sub>	-	2.1	2.6	V	I <sub>F</sub> = 20mA
Reverse Current, Per Segment	I <sub>R</sub>	-	-	100	μA	V <sub>R</sub> = 5V
Luminous Intensity Matching Ratio	I <sub>V-M</sub>	-	-	2:1	-	I <sub>F</sub> = 10mA

### Red

Parameters	Symbol	Min	Typ	Max	Unit	Test Condition
Average Luminous Intensity	I <sub>V</sub>	8.6	14.3	-	Mcd	I <sub>F</sub> = 10mA
Emissions Wavelength	λ <sub>p</sub> /λ <sub>d</sub>	-	644/630	-	Nm	I <sub>F</sub> = 20mA
Spectral Line Half-Width	Δλ	-	20	-	Nm	I <sub>F</sub> = 20mA
Forward Voltage, Per Segment	V <sub>F</sub>	-	2.0	2.6	V	I <sub>F</sub> = 20mA
Reverse Current, Per Segment	I <sub>R</sub>	-	-	100	μA	V <sub>R</sub> = 5V
Luminous Intensity Matching Ratio	I <sub>V-M</sub>	-	-	2:1	-	I <sub>F</sub> = 10mA

### Orange

Parameters	Symbol	Min	Typ	Max	Unit	Test Condition
Average Luminous Intensity	I <sub>V</sub>	8.6	16	-	Mcd	I <sub>F</sub> = 10mA
Emissions Wavelength	λ <sub>p</sub> /λ <sub>d</sub>	-	611/605	-	Nm	I <sub>F</sub> = 20mA
Spectral Line Half-Width	Δλ	-	17	-	Nm	I <sub>F</sub> = 20mA
Forward Voltage, Per Segment	V <sub>F</sub>	-	2.1	2.6	V	I <sub>F</sub> = 20mA
Reverse Current, Per Segment	I <sub>R</sub>	-	-	100	μA	V <sub>R</sub> = 5V
Luminous Intensity Matching Ratio	I <sub>V-M</sub>	-	-	2:1	-	I <sub>F</sub> = 10mA

**Typical Electrical / Optical characteristic curves @  $T_A=25^\circ\text{C}$**   
**Green**

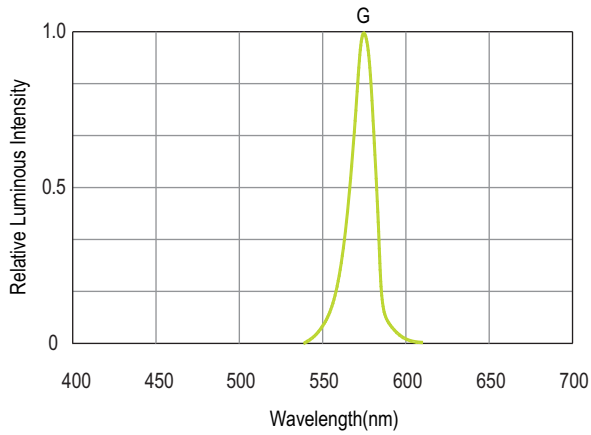

**Figure 1. Relative Luminous Intensity vs. Wavelength**

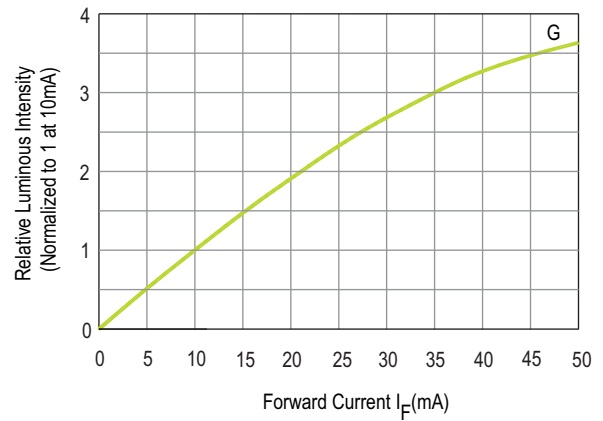

**Figure 2. Relative Luminous Intensity vs. Forward Current**

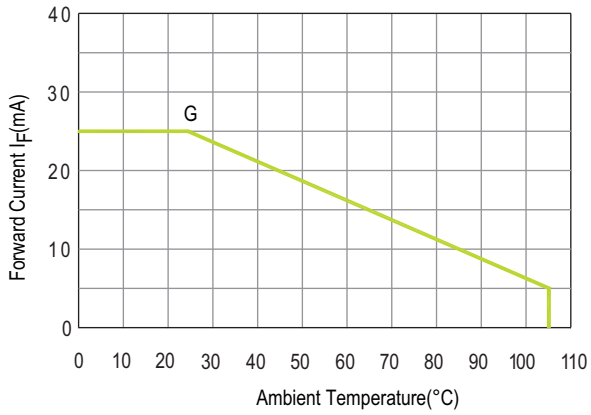

**Figure 3. Allowable DC Current vs. Ambient Temperature**

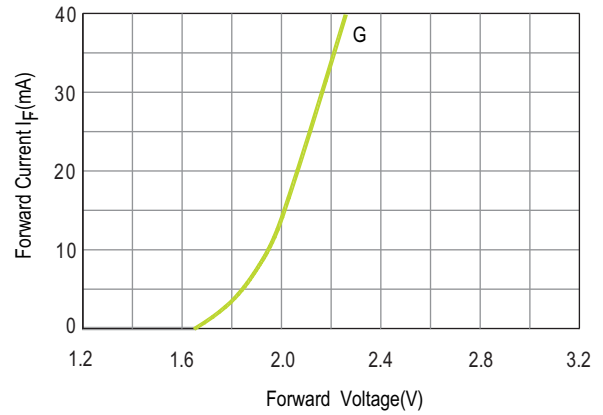

**Figure 4. Forward Current vs. Forward Voltage**

## Yellow

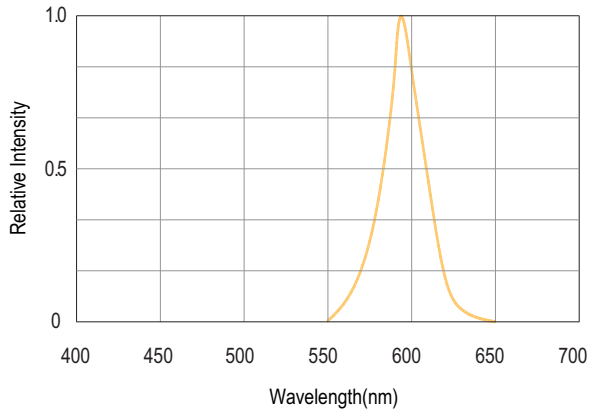

Figure 1. Relative Intensity vs. Wavelength

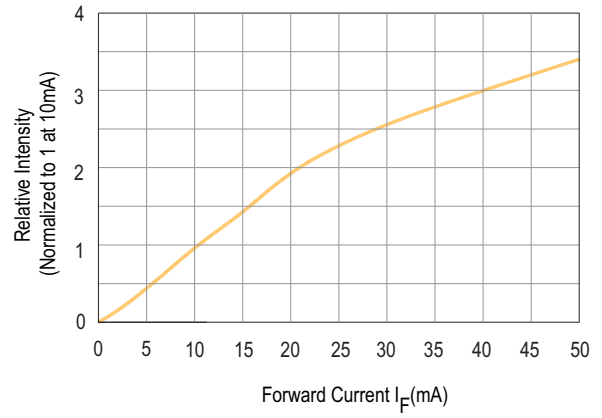

Figure 2. Relative Intensity vs. Forward Current

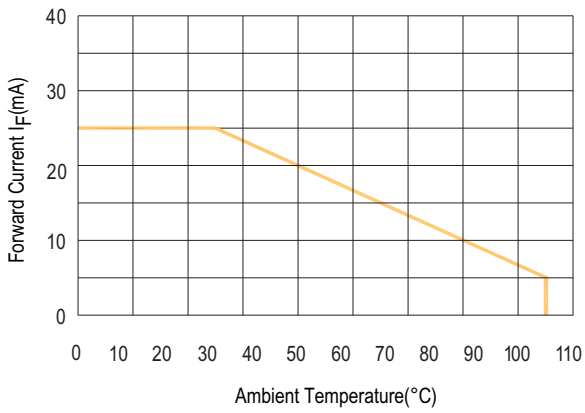

Figure 3. Allowable DC Current vs. Ambient Temperature

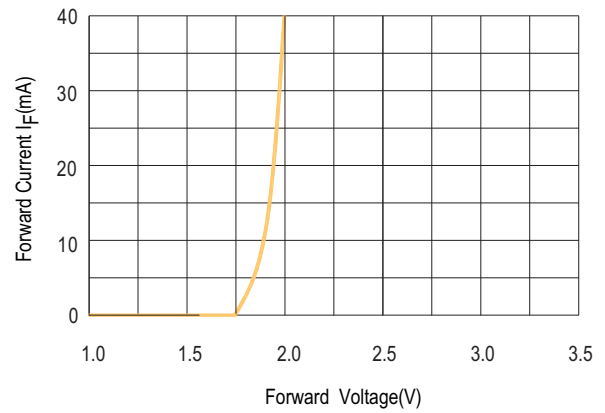

Figure 4. Forward Current vs. Forward Voltage

### Red

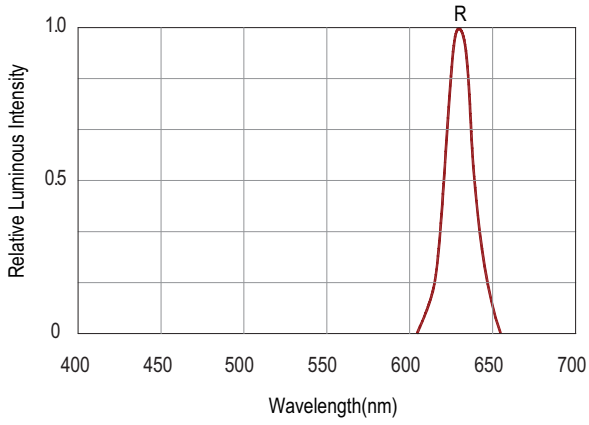

Figure 1. Relative Luminous Intensity vs. Wavelength

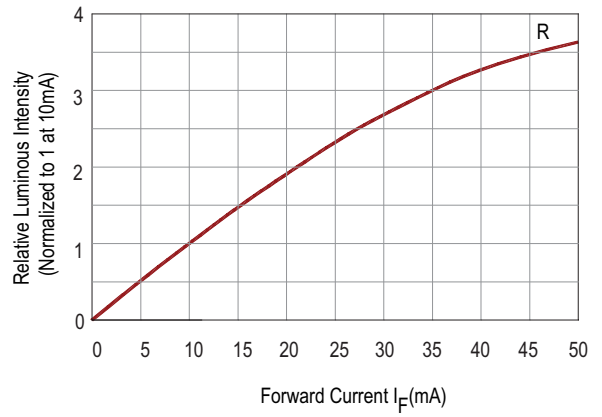

Figure 2. Relative Luminous Intensity vs. Forward Current

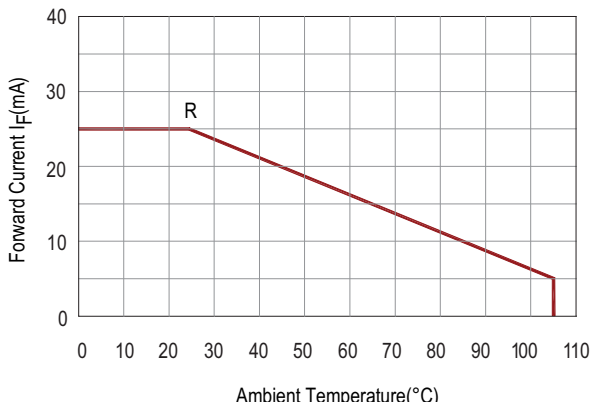

Figure 3. Allowable DC Current vs. Ambient Temperature

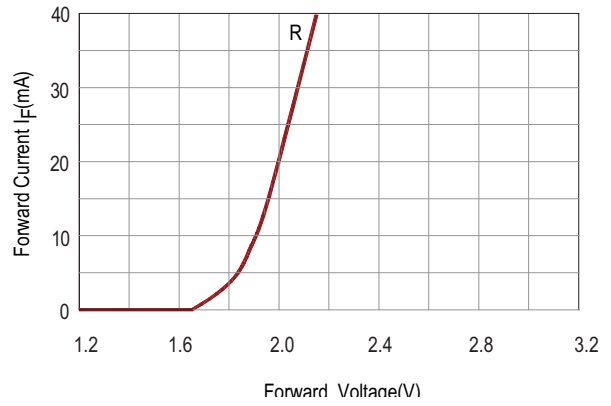

Figure 4. Forward Current vs. Forward Voltage

## Orange

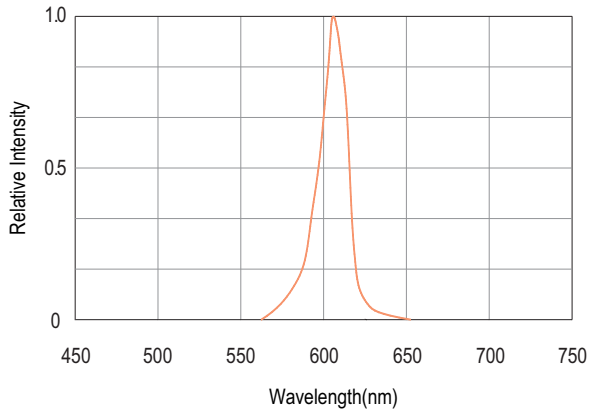

Figure 1. Relative Intensity vs. Wavelength

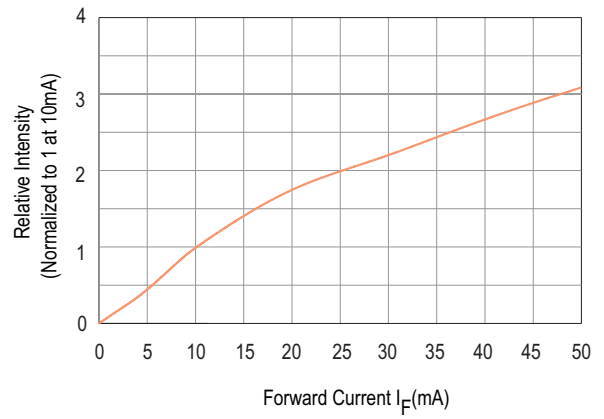

Figure 2. Relative Intensity vs. Forward Current

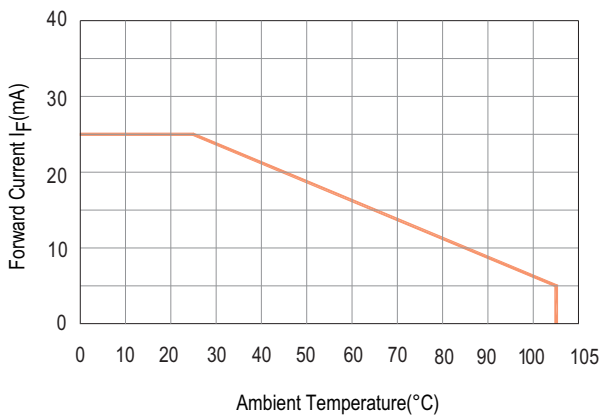

Figure 3. Allowable DC Current vs. Ambient Temperature

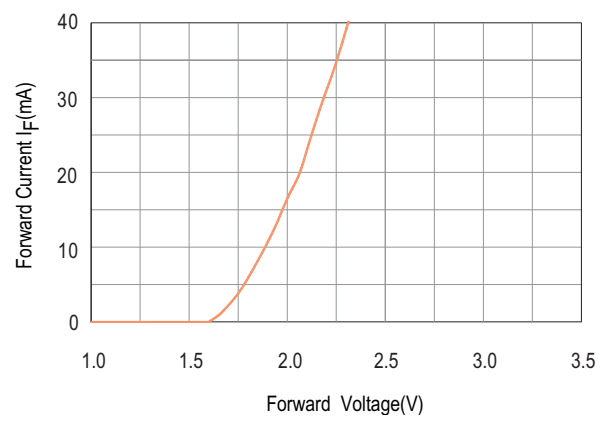

Figure 4. Forward Current vs. Forward Voltage

## Intensity Bin Limits (mcd)

### Green

IV Bin Category	Min.	Max.
M	5.401	8.6
N	8.601	13.7
P	13.701	21.8

Tolerance: ±15%

### Yellow

IV Bin Category	Min.	Max.
N	8.601	13.7
P	13.701	21.80
Q	21.801	34.7

Tolerance: ±15%

### Red

IV Bin Category	Min.	Max.
N	8.601	13.7
P	13.701	21.80
Q	21.801	34.7

Tolerance: ±15%

### Orange

IV Bin Category	Min.	Max.
N	8.601	13.7
P	13.701	21.80
Q	21.801	34.7
R	34.701	55.2

Tolerance: ±15%

Note:

- Bin categories are established for classification of products. Products may not be available in all categories. Please contact your Avago representative for information on currently available bins.

## SMT Soldering Profile

### Pb free reflow soldering Profile

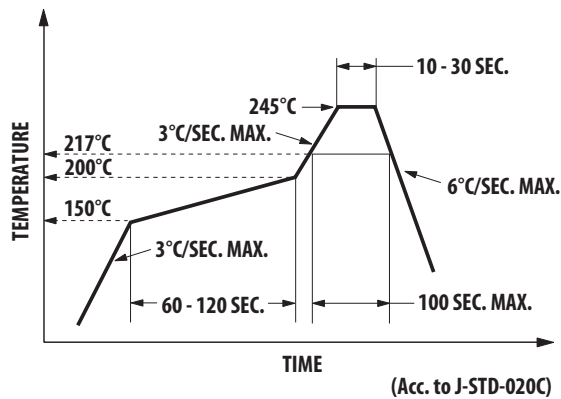

Notes:

- The peak temperature refers to the peak package body temperature.
- Number of reflow process shall be limited to maximum 2 times only. Cooling process to normal temperature is required between first and second soldering process.

## Recommended soldering pattern (unit: mm)

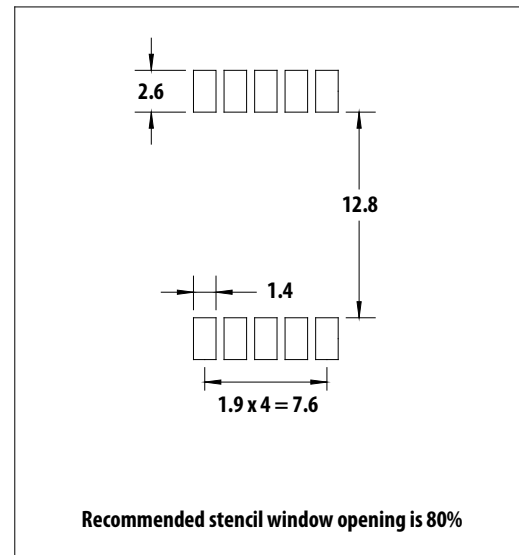



**Tape specification (unit: mm)**

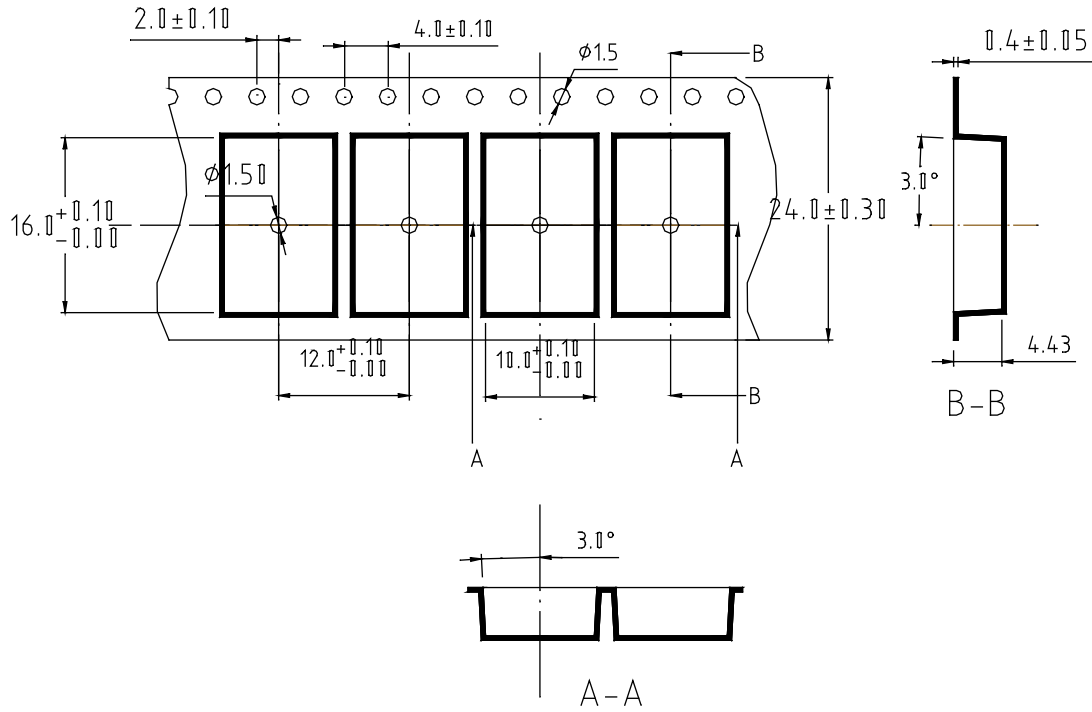

For product information and a complete list of distributors, please go to our web site: [www.avagotech.com](http://www.avagotech.com)

Avago, Avago Technologies, and the A logo are trademarks of Avago Technologies in the United States and other countries. Data subject to change. Copyright © 2005-2011 Avago Technologies. All rights reserved. AV02-0708EN - March 17, 2011





Компания «ЭлектроПласт» предлагает заключение долгосрочных отношений при поставках импортных электронных компонентов на взаимовыгодных условиях!

Наши преимущества:

- Оперативные поставки широкого спектра электронных компонентов отечественного и импортного производства напрямую от производителей и с крупнейших мировых складов;
- Поставка более 17-ти миллионов наименований электронных компонентов;
- Поставка сложных, дефицитных, либо снятых с производства позиций;
- Оперативные сроки поставки под заказ (от 5 рабочих дней);
- Экспресс доставка в любую точку России;
- Техническая поддержка проекта, помощь в подборе аналогов, поставка прототипов;
- Система менеджмента качества сертифицирована по Международному стандарту ISO 9001;
- Лицензия ФСБ на осуществление работ с использованием сведений, составляющих государственную тайну;
- Поставка специализированных компонентов (Xilinx, Altera, Analog Devices, Intersil, Interpoint, Microsemi, Aeroflex, Peregrine, Syfer, Eurofarad, Texas Instrument, Miteq, Cobham, E2V, MA-COM, Hittite, Mini-Circuits, General Dynamics и др.);

Помимо этого, одним из направлений компании «ЭлектроПласт» является направление «Источники питания». Мы предлагаем Вам помощь Конструкторского отдела:

- Подбор оптимального решения, техническое обоснование при выборе компонента;
- Подбор аналогов;
- Консультации по применению компонента;
- Поставка образцов и прототипов;
- Техническая поддержка проекта;
- Защита от снятия компонента с производства.



#### Как с нами связаться

**Телефон:** 8 (812) 309 58 32 (многоканальный)

**Факс:** 8 (812) 320-02-42

**Электронная почта:** [org@eplast1.ru](mailto:org@eplast1.ru)

**Адрес:** 198099, г. Санкт-Петербург, ул. Калинина, дом 2, корпус 4, литера А.