

## Cree® XLamp® XP-E2 LEDs



### PRODUCT DESCRIPTION

The XLamp® XP-E2 LED builds on the unprecedented performance of the original XP-E by increasing lumen output up to 20% while providing a single die LED point source for precise optical control. The XP-E2 LED shares the same footprint as the original XP-E, providing a seamless upgrade path to more lumens and/or greater efficiency while shortening the design cycle for existing XP customers.

XLamp XP-E2 LEDs are the ideal choice for lighting applications where high light output and maximum efficacy are required, such as LED retrofit lamps, outdoor, portable, indoor directional, emergency vehicle or architectural.

### FEATURES

- Available in white, outdoor white, 80-CRI, 85-CRI, 90-CRI white, royal blue, blue, green, PC amber, amber, red-orange & red
- ANSI-compatible chromaticity bins
- White binned at 85 °C
- Maximum drive current: 1 A
- Low thermal resistance: as low as 5 °C/W
- Wide viewing angle: 110°-135°
- Unlimited floor life at ≤ 30 °C/85% RH
- Reflow solderable - JEDEC J-STD-020C compatible
- Electrically neutral thermal path
- RoHS- and REACH-compliant
- UL® recognized component (E349212)

### TABLE OF CONTENTS

Characteristics .....	2
Flux Characteristics - White.....	3
Flux Characteristics - Color .....	4
Relative Spectral Power Distribution .....	6
Relative Flux vs. Junction Temperature.....	7
Electrical Characteristics - White .....	8
Electrical Characteristics - Color.....	8
Relative Flux vs. Current - White.....	9
Relative Flux vs. Current - Color .....	9
Relative Chromaticity vs. Current and Temperature .....	10
Typical Spatial Distribution.....	11
Thermal Design .....	12
Reflow Soldering Characteristics.....	13
Notes .....	14
Mechanical Dimensions .....	16
Tape and Reel.....	17
Packaging.....	18



**CHARACTERISTICS**

Characteristics	Unit	Minimum	Typical	Maximum
Thermal resistance, junction to solder point - white, royal blue, blue	°C/W		9	
Thermal resistance, junction to solder point - green	°C/W		15	
Thermal resistance, junction to solder point - PC amber	°C/W		9	
Thermal resistance, junction to solder point - amber	°C/W		7	
Thermal resistance, junction to solder point - red-orange, red	°C/W		5	
Viewing angle (FWHM) - white	degrees		110	
Viewing angle (FWHM) - royal blue, blue, green	degrees		135	
Viewing angle (FWHM) - PC amber	degrees		110	
Viewing angle (FWHM) - amber, red-orange, red	degrees		130	
Temperature coefficient of voltage - white	mV/°C		-2.3	
Temperature coefficient of voltage - royal blue, blue	mV/°C		-3.3	
Temperature coefficient of voltage - green	mV/°C		-3.8	
Temperature coefficient of voltage - PC amber	mV/°C		-2.5	
Temperature coefficient of voltage - amber, red-orange, red	mV/°C		-1.8	
ESD withstand voltage (HBM per Mil-Std-883D)- white, royal blue, blue, green	V			8000
ESD classification (HBM per Mil-Std-883D) - PC amber, amber, red-orange, red			Class 2	
DC forward current	mA			1000
Reverse voltage	V			5
Forward voltage (@ 350 mA, 85 °C) - white	V		2.9	3.25
Forward voltage (@ 700 mA, 85 °C) - white			3.05	
Forward voltage (@ 1000 mA, 85 °C) - white			3.15	
Forward voltage (@ 350 mA, 25 °C) - royal blue, blue	V		3.1	3.5
Forward voltage (@ 1000 mA, 25 °C) - royal blue, blue	V		3.4	
Forward voltage (@ 350 mA, 25 °C) - green	V		3.2	3.8
Forward voltage (@ 1000 mA, 25 °C) - green	V		3.7	
Forward voltage (@ 350 mA, 25 °C) - PC amber	V		3.05	3.5
Forward voltage (@ 1000 mA, 25 °C) - PC amber	V		3.28	
Forward voltage (@ 350 mA, 25 °C) - amber, red-orange, red	V		2.2	2.6
Forward voltage (@ 1000 mA, 25 °C) - amber, red-orange, red	V		2.65	
LED junction temperature	°C			150

## FLUX CHARACTERISTICS (T<sub>J</sub> = 85 °C) - WHITE

The following table provides several base order codes for XLamp XP-E2 LEDs. It is important to note that the base order codes listed here are a subset of the total available order codes for the product family. For more order codes, as well as a complete description of the order-code nomenclature, please consult the XLamp XP Family LEDs Binning and Labeling document.

Color	CCT Range		Minimum Luminous Flux (lm) @ 350 mA			Calculated Minimum Luminous Flux (lm)** @ 85 °C		Order Code
	Min.	Max.	Group	Flux (lm) @ 85 °C	Flux (lm) @ 25 °C*	700 mA	1.0 A	
Cool White	5000 K	10,000 K	Q4	100	116	171	218	XPEBWT-L1-0000-00C51
			Q5	107	124	183	233	XPEBWT-L1-0000-00D51
			R2	114	132	195	249	XPEBWT-L1-0000-00E51
			R3	122	142	209	266	XPEBWT-L1-0000-00F51
			R4	130	152	223	284	XPEBWT-L1-0000-00G51
Outdoor White	4000 K	5300 K	Q4	100	116	171	218	XPEBWT-01-0000-00CC2
			Q5	107	124	183	233	XPEBWT-01-0000-00DC2
			R2	114	132	195	249	XPEBWT-01-0000-00EC2
			R3	122	142	209	266	XPEBWT-01-0000-00FC2
Neutral White	3700 K	5300 K	Q4	100	116	171	218	XPEBWT-L1-0000-00CE4
			Q5	107	124	183	233	XPEBWT-L1-0000-00DE4
			R2	114	132	195	249	XPEBWT-L1-0000-00EE4
80-CRI White	2200 K	4300 K	Q2	87.4	101	150	191	XPEBWT-H1-0000-00AE7
			Q3	93.9	109	161	205	XPEBWT-H1-0000-00BE7
Warm White	2200 K	3700 K	Q2	87.4	101	150	191	XPEBWT-L1-0000-00AE7
			Q3	93.9	109	161	205	XPEBWT-L1-0000-00BE7
			Q4	100	116	171	218	XPEBWT-L1-0000-00CE7
85-CRI White	2600 K	3200 K	P2	67.2	78.0	115	147	XPEBWT-P1-0000-007E7
			P3	73.9	85.7	127	161	XPEBWT-P1-0000-008E7
			P4	80.6	93.5	138	176	XPEBWT-P1-0000-009E7
			Q2	87.4	101	150	191	XPEBWT-P1-0000-00AE7
90-CRI White	2600 K	3200 K	P2	67.2	78.0	115	147	XPEBWT-U1-0000-007E7
			P3	73.9	85.7	127	161	XPEBWT-U1-0000-008E7
			P4	80.6	93.5	138	176	XPEBWT-U1-0000-009E7

### Notes:

- Cree maintains a tolerance of ±7% on flux and power measurements, ±0.005 on chromaticity (CCx, CCy) measurements and ±2 on CRI measurements. See the Measurements section (page 14).
- Typical CRI for Cool White (5000 K – 10,000 K CCT) is 70.
- Typical CRI for Neutral White (3700 K – 5300 K CCT) is 75.
- Typical CRI for Outdoor White (4000 K - 5300 K CCT) is 70.
- Typical CRI for Warm White (2200 K – 3700 K CCT) is 80.
- Minimum CRI for 80-CRI White is 80.
- Minimum CRI for 85-CRI White is 85.
- Minimum CRI for 90-CRI White is 90.
- \* Flux values @ 25 °C are calculated and for reference only.
- \*\* Calculated flux values at 700 mA and 1 A are for reference only.

## FLUX CHARACTERISTICS ( $T_j = 25\text{ }^\circ\text{C}$ ) - COLOR

The following tables provide several base order codes for XLamp XP-E2 color LEDs. It is important to note that the base order codes listed here are a subset of the total available order codes for the product family. For more order codes, as well as a complete description of the order-code nomenclature, please consult the XLamp XP Family LEDs Binning and Labeling document.

Color	Minimum Radiant Flux @ 350 mA		Dominant Wavelength Range				Order Codes,
	Group	Flux (mW)	Min.		Max.		
			Group	DWL (nm)	Group	DWL (nm)	
Royal Blue	30	450	D3	450	D5	465	XPEBRY-L1-0000-00J01
	31	475	D3	450	D5	465	XPEBRY-L1-0000-00K01
	32	500	D3	450	D5	465	XPEBRY-L1-0000-00L01
	33	525	D3	450	D5	465	XPEBRY-L1-0000-00M01
	34	550	D3	450	D5	465	XPEBRY-L1-0000-00N01
	35	575	D3	450	D5	465	XPEBRY-L1-0000-00P01
	36	600	D3	450	D5	465	XPEBRY-L1-0000-00Q01
	37	625	D3	450	D5	465	XPEBRY-L1-0000-00R01

Color	Dominant Wavelength Range				Minimum Luminous Flux (lm) @ 350 mA		Order Code
	Min.		Max.		Group	Flux (lm)	
	Group	DWL (nm)	Group	DWL (nm)			
Blue	B3	465	B6	485	K2	30.6	XPEBBL-L1-0000-00Y01
					K3	35.2	XPEBBL-L1-0000-00Z01
					M2	39.8	XPEBBL-L1-0000-00201
					M3	45.7	XPEBBL-L1-0000-00301

Color	Dominant Wavelength Range				Minimum Luminous Flux (lm) @ 350 mA		Order Code
	Min.		Max.		Group	Flux (lm)	
	Group	DWL (nm)	Group	DWL (nm)			
Green	G2	520	G4	535	Q2	87.4	XPEBGR-L1-0000-00A01
					Q3	93.9	XPEBGR-L1-0000-00B01
					Q4	100	XPEBGR-L1-0000-00C01
					Q5	107	XPEBGR-L1-0000-00D01
					R2	114	XPEBGR-L1-0000-00E01
					R3	122	XPEBGR-L1-0000-00F01
					R4	130	XPEBGR-L1-0000-00G01

- Note:
- Cree maintains a tolerance of  $\pm 7\%$  on flux and power measurements,  $\pm 0.005$  on chromaticity (CCx, CCy) measurements and  $\pm 2$  on CRI measurements.

**FLUX CHARACTERISTICS (T<sub>j</sub> = 25 °C) - COLOR (CONTINUED)**

Color	Color Bin	Minimum Luminous Flux (lm) @ 350 mA		Order Code
		Group	Flux (lm)	
PC Amber	Y2	Q2	87.4	XPEBPA-L1-0000-00A01
		Q3	93.9	XPEBPA-L1-0000-00B01
		Q4	100	XPEBPA-L1-0000-00C01
		Q5	107	XPEBPA-L1-0000-00D01

Color	Dominant Wavelength Range				Minimum Luminous Flux (lm) @ 350 mA		Order Code
	Min.		Max.		Group	Flux (lm)	
	Group	DWL (nm)	Group	DWL (nm)			
Amber	A2	585	A3	595	N4	62.0	XPEBAM-L1-0000-00601
					P2	67.2	XPEBAM-L1-0000-00701
					P3	73.9	XPEBAM-L1-0000-00801
					P4	80.6	XPEBAM-L1-0000-00901

Color	Dominant Wavelength Range				Minimum Luminous Flux (lm) @ 350 mA		Order Code
	Min.		Max.		Group	Flux (lm)	
	Group	DWL (nm)	Group	DWL (nm)			
Red-Orange	O3	610	O4	620	P2	67.2	XPEBRO-L1-0000-00701
					P3	73.9	XPEBRO-L1-0000-00801
					P4	80.6	XPEBRO-L1-0000-00901
					Q2	87.4	XPEBRO-L1-0000-00A01
					Q3	93.9	XPEBRO-L1-0000-00B01
					Q4	100	XPEBRO-L1-0000-00C01
					Q5	107	XPEBRO-L1-0000-00D01

Color	Dominant Wavelength Range				Minimum Luminous Flux (lm) @ 350 mA		Order Code
	Min.		Max.		Group	Flux (lm)	
	Group	DWL (nm)	Group	DWL (nm)			
Red	R2	620	R3	630	N3	56.8	XPEBRD-L1-0000-00501
					N4	62.0	XPEBRD-L1-0000-00601
					P2	67.2	XPEBRD-L1-0000-00701
					P3	73.9	XPEBRD-L1-0000-00801
					P4	80.6	XPEBRD-L1-0000-00901

Note:  
 • Cree maintains a tolerance of ±7% on flux and power measurements, ±0.005 on chromaticity (CCx, CCy) measurements and ±2 on CRI measurements.

**RELATIVE SPECTRAL POWER DISTRIBUTION**



**RELATIVE FLUX VS. JUNCTION TEMPERATURE ( $I_F = 350$  mA)**

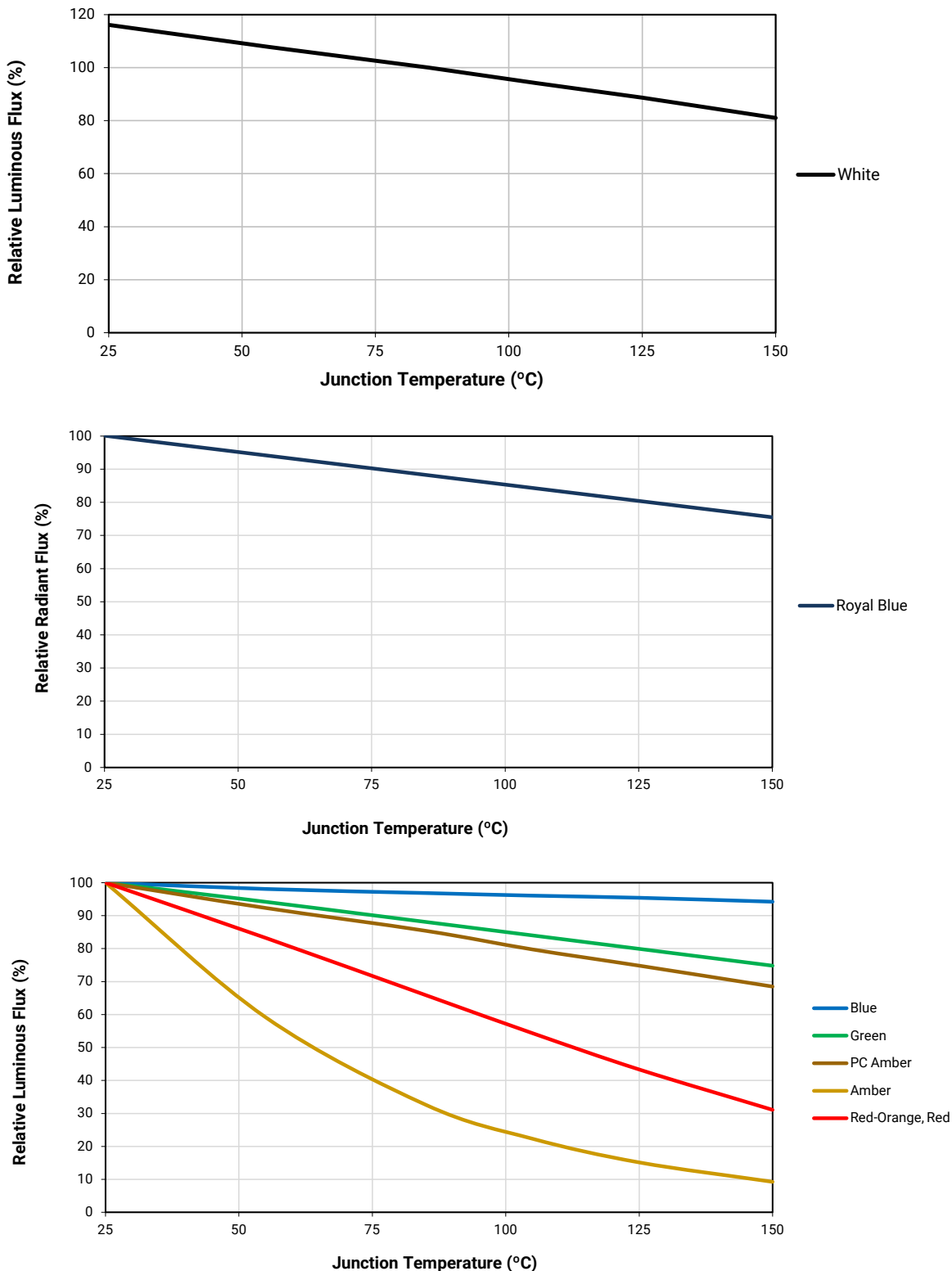

**ELECTRICAL CHARACTERISTICS ( $T_j = 85\text{ }^\circ\text{C}$ ) - WHITE**



**ELECTRICAL CHARACTERISTICS ( $T_j = 25\text{ }^\circ\text{C}$ ) - COLOR**

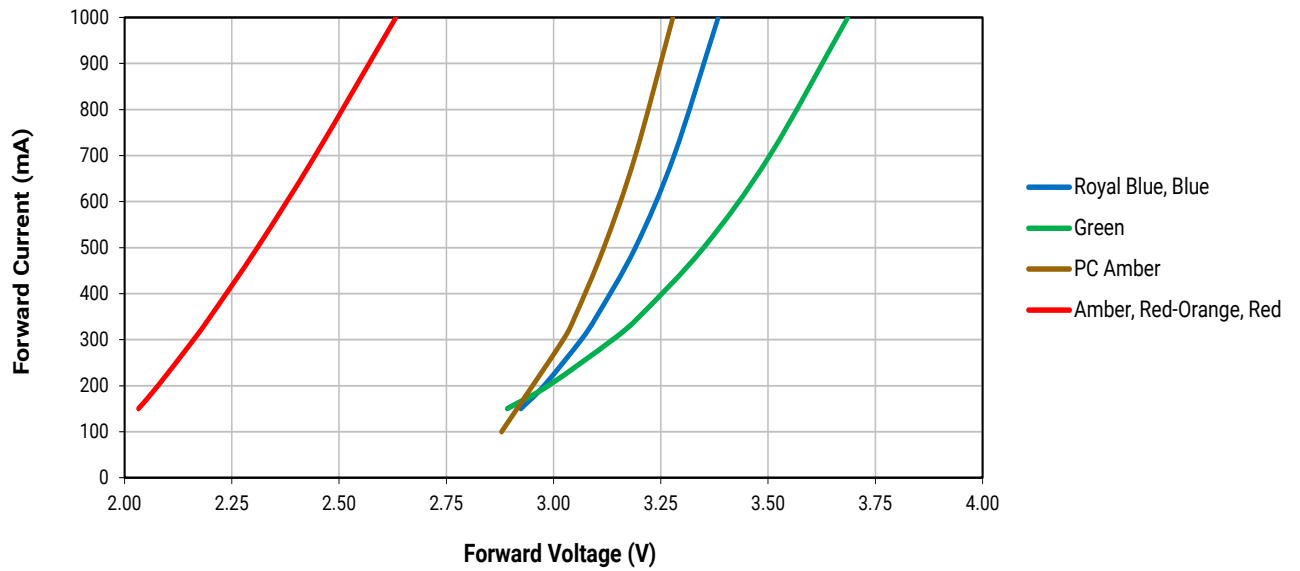



**RELATIVE FLUX VS. CURRENT ( $T_j = 85\text{ }^\circ\text{C}$ ) - WHITE**



**RELATIVE FLUX VS. CURRENT ( $T_j = 25\text{ }^\circ\text{C}$ ) - COLOR**

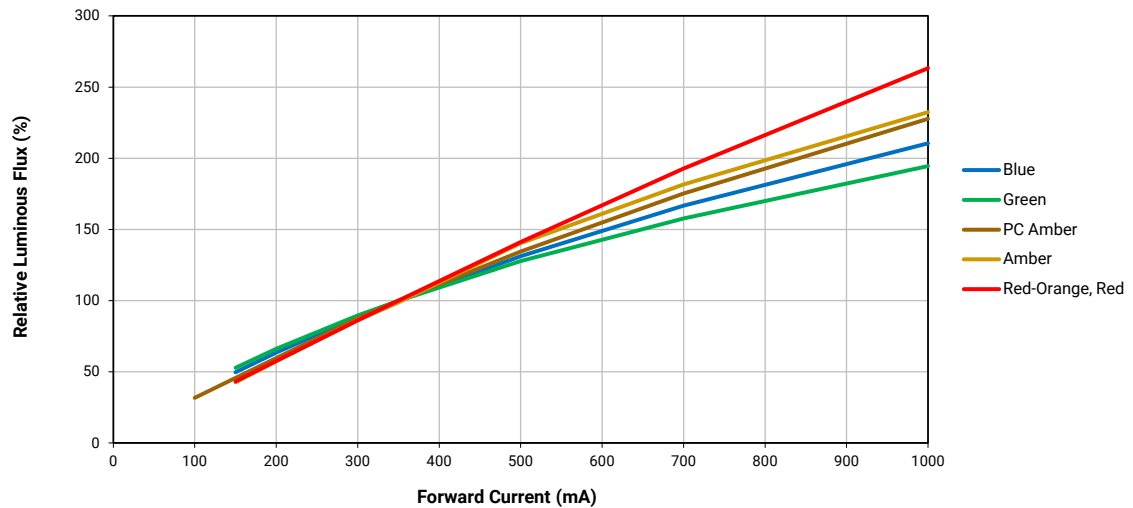

**RELATIVE CHROMATICITY VS. CURRENT AND TEMPERATURE - WARM WHITE\***



\* Warm White XLamp XP-E2 LEDs have a typical CRI of 80.

**TYPICAL SPATIAL DISTRIBUTION**



**THERMAL DESIGN**

The maximum forward current is determined by the thermal resistance between the LED junction and ambient. It is crucial for the end product to be designed in a manner that minimizes the thermal resistance from the solder point to ambient in order to optimize lamp life and optical characteristics.

**White**

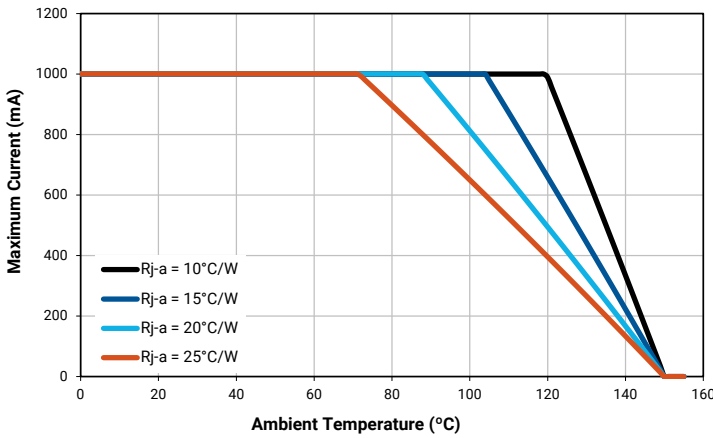

**Royal Blue, Blue**

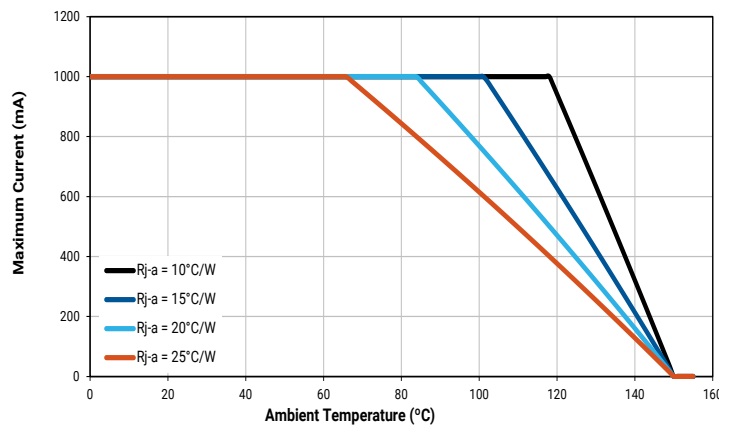

**Green**



**Amber**



**PC Amber**



**Red-Orange, Red**



**REFLOW SOLDERING CHARACTERISTICS**

In testing, Cree has found XLamp XP-E2 LEDs to be compatible with JEDEC J-STD-020C, using the parameters listed below. As a general guideline, Cree recommends that users follow the recommended soldering profile provided by the manufacturer of the solder paste used.

Note that this general guideline may not apply to all PCB designs and configurations of reflow soldering equipment.



IPC/JEDEC J-STD-020C

Profile Feature	Lead-Free Solder
Average Ramp-Up Rate ( $T_{s_{max}}$ to $T_P$ )	1.2 °C/second
Preheat: Temperature Min ( $T_{s_{min}}$ )	120 °C
Preheat: Temperature Max ( $T_{s_{max}}$ )	170 °C
Preheat: Time ( $t_{s_{min}}$ to $t_{s_{max}}$ )	65-150 seconds
Time Maintained Above: Temperature ( $T_L$ )	217 °C
Time Maintained Above: Time ( $t_s$ )	45-90 seconds
Peak/Classification Temperature ( $T_P$ )	235 - 245 °C
Time Within 5 °C of Actual Peak Temperature ( $t_p$ )	20-40 seconds
Ramp-Down Rate	1 - 6 °C/second
Time 25 °C to Peak Temperature	4 minutes max.

Note: All temperatures refer to topside of the package, measured on the package body surface.

## NOTES

---

### Measurements

The luminous flux, radiant power, chromaticity and CRI measurements in this document are binning specifications only and solely represent product measurements as of the date of shipment. These measurements will change over time based on a number of factors that are not within Cree's control and are not intended or provided as operational specifications for the products. Calculated values are provided for informational purposes only and are not intended as specifications.

### Lumen Maintenance

Cree now uses standardized IES LM-80-08 and TM-21-11 methods for collecting long-term data and extrapolating LED lumen maintenance. For information on the specific LM-80 data sets available for this LED, refer to the [LM-80 results document](#).

Please read the [Long-Term Lumen Maintenance application note](#) for more details on Cree's lumen maintenance testing and forecasting. Please read the [Thermal Management application note](#) for details on how thermal design, ambient temperature, and drive current affect the LED junction temperature.

### Moisture Sensitivity

Cree recommends keeping XLamp LEDs in the provided, resealable moisture-barrier packaging (MBP) until immediately prior to soldering. Unopened MBPs that contain XLamp LEDs do not need special storage for moisture sensitivity.

Once the MBP is opened, XLamp XP-E2 LEDs may be stored as MSL 1 per JEDEC J-STD-033, meaning they have unlimited floor life in conditions of  $\leq 30$  °C/85% relative humidity (RH). Regardless of the storage condition, Cree recommends sealing any unsoldered LEDs in the original MBP.

### RoHS Compliance

The levels of RoHS restricted materials in this product are below the maximum concentration values (also referred to as the threshold limits) permitted for such substances, or are used in an exempted application, in accordance with EU Directive 2011/65/EC (RoHS2), as implemented January 2, 2013. RoHS Declarations for this product can be obtained from your Cree representative or from the Product Documentation sections of [www.cree.com](http://www.cree.com).

### REACH Compliance

REACH substances of very high concern (SVHCs) information is available for this product. Since the European Chemical Agency (ECHA) has published notice of their intent to frequently revise the SVHC listing for the foreseeable future, please contact a Cree representative to insure you get the most up-to-date REACH SVHC Declaration. REACH banned substance information (REACH Article 67) is also available upon request.

### UL® Recognized Component

Level 4 enclosure consideration. The LED package or a portion thereof has been investigated as a fire and electrical enclosure per ANSI/UL 8750.

**NOTES - CONTINUED**

---

**Vision Advisory**

WARNING: Do not look at exposed lamp in operation. Eye injury can result. For more information about LEDs and eye safety, please refer to the [LED Eye Safety application note](#).

**MECHANICAL DIMENSIONS**

Thermal vias, if present, are not shown on these drawings.

All measurements are  $\pm 0.13$  mm unless otherwise indicated.





**TAPE AND REEL**

All Cree carrier tapes conform to EIA-481D, Automated Component Handling Systems Standard.

All dimensions in mm.



Ao	3.70	+/- 0.1
Bo	3.70	+/- 0.1
Ko	2.40	+0.0/-0.1
F	5.50	+/- 0.05
P 1	8.00	+/- 0.1
W	12.00	+0.3/-0.1

- (I) Measured from centerline of sprocket hole to centerline of pocket.
- (II) Cumulative tolerance of 10 sprocket holes is ± 0.20.
- (III) Measured from centerline of sprocket hole to centerline of pocket.
- (IV) Other material available.



**PACKAGING**

**Unpackaged Reel**

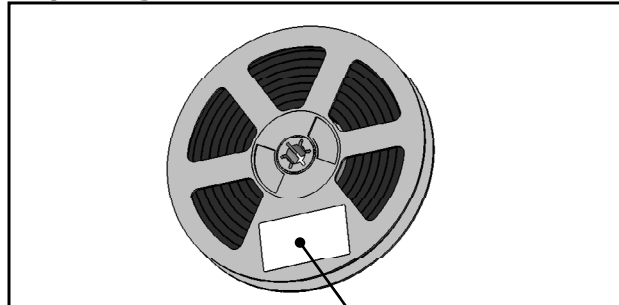

Label with Cree Bin Code,  
Quantity, Reel ID

**Packaged Reel**

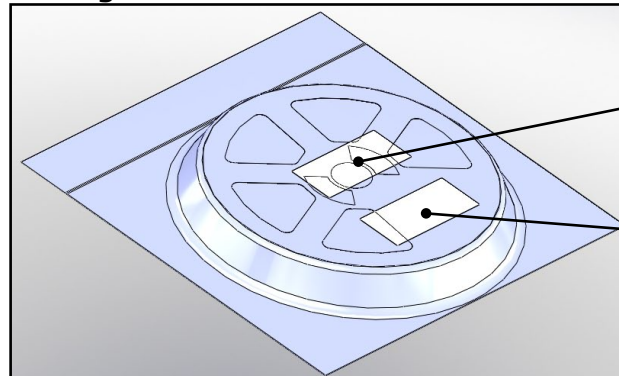

Label with Cree Order Code,  
Quantity, Reel ID, PO #

Label with Cree Bin Code,  
Quantity, Reel ID

**Boxed Reel**

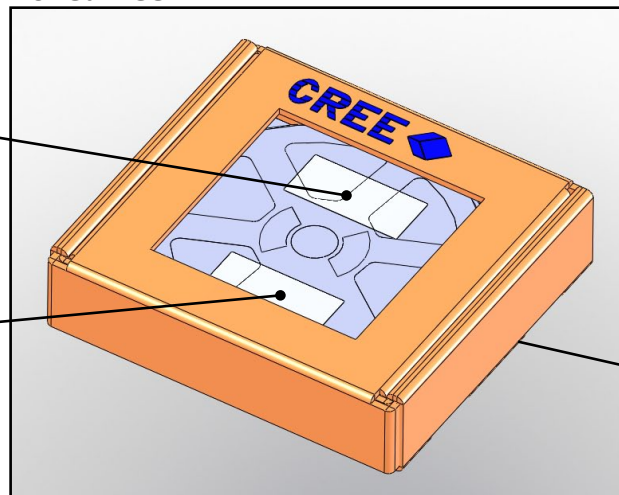

Label with Cree Order Code,  
Quantity, Reel ID, PO #

Label with Cree Bin Code,  
Quantity, Reel ID

Patent Label  
(on bottom of box)



Компания «ЭлектроПласт» предлагает заключение долгосрочных отношений при поставках импортных электронных компонентов на взаимовыгодных условиях!

Наши преимущества:

- Оперативные поставки широкого спектра электронных компонентов отечественного и импортного производства напрямую от производителей и с крупнейших мировых складов;
- Поставка более 17-ти миллионов наименований электронных компонентов;
- Поставка сложных, дефицитных, либо снятых с производства позиций;
- Оперативные сроки поставки под заказ (от 5 рабочих дней);
- Экспресс доставка в любую точку России;
- Техническая поддержка проекта, помощь в подборе аналогов, поставка прототипов;
- Система менеджмента качества сертифицирована по Международному стандарту ISO 9001;
- Лицензия ФСБ на осуществление работ с использованием сведений, составляющих государственную тайну;
- Поставка специализированных компонентов (Xilinx, Altera, Analog Devices, Intersil, Interpoint, Microsemi, Aeroflex, Peregrine, Syfer, Eurofarad, Texas Instrument, Miteq, Cobham, E2V, MA-COM, Hittite, Mini-Circuits, General Dynamics и др.);

Помимо этого, одним из направлений компании «ЭлектроПласт» является направление «Источники питания». Мы предлагаем Вам помощь Конструкторского отдела:

- Подбор оптимального решения, техническое обоснование при выборе компонента;
- Подбор аналогов;
- Консультации по применению компонента;
- Поставка образцов и прототипов;
- Техническая поддержка проекта;
- Защита от снятия компонента с производства.



#### Как с нами связаться

**Телефон:** 8 (812) 309 58 32 (многоканальный)

**Факс:** 8 (812) 320-02-42

**Электронная почта:** [org@eplast1.ru](mailto:org@eplast1.ru)

**Адрес:** 198099, г. Санкт-Петербург, ул. Калинина, дом 2, корпус 4, литера А.