

AUMOV™ Varistor Series



Agency Approvals

| Agency | Agency File Number |
|---|-----------------------------|
|  | E320116 (only Epoxy coated) |

Note: All Phenolic coating parts are in compliance with AEC-Q200 (Table 10).

Description

The Littelfuse AUMOV™ Varistor Series of low voltage, high surge current, radial leaded varistors provides an ideal circuit protection for load dump, jump start voltage transient conditions specifically for automotive applications.

The maximum peak surge current rating is rated up to 5kA (8/20 μs pulse) to protect sensitive infotainment systems from voltage transients. This AEC-Q200 (Table 10) compliant series is available in five disc sizes: 5mm, 7mm, 10mm, 14mm and 20mm; it features a wide VDC voltage range from 16V to 50V.

Features

- Meets the stringent quality standards of AEC-Q200 (Table 10)
- Breakthrough in low voltage varistor design provides high peak surge current rating
- Reduced footprint and volume required for surge protection
- Optional phenolic coating for higher operating temperature up to 125°C
- High peak surge current rating up to 5kA (8/20 μs pulse)
- Wide operating voltage range: 14VAC to 42VAC and 16VDC to 50VDC
- Five disc sizes available: 5, 7, 10, 14, and 20mm
- High resistance to thermal cycles for phenolic coating
- High energy absorption particularly for automotive load dump and jump start
- Lead-free, Halogen-Free and RoHS compliant

Applications

- Body Electronics Systems
- Powertrain Systems
- Infotainment Systems
- Automotive Control Module Protection
- Motor or inductive load transient suppression

Absolute Maximum Ratings

• For ratings of individual members of a series, see Device Ratings and Specifications chart

| | Low Voltage Series | Units |
|--|--------------------|-------|
| Continuous: | | |
| Steady State Applied Voltage: | | |
| AC Voltage Range ($V_{M(AC)RMS}$) | 14 to 42 | V |
| DC Voltage Range ($V_{M(DC)}$) | 16 to 50 | V |
| Transient: | | |
| Non-Repetitive Surge Current, 8/20μs Waveform (I_{TM}) | 400 to 5,000 | A |
| Non-Repetitive Energy Capability, 2ms Waveform (W_{TM}) | 1.0 to 140 | J |
| Operating Ambient Temperature Range (T_A) for Epoxy coated | -40 to +85 | °C |
| Operating Ambient Temperature Range (T_A) for Phenolic coated | -40 to +125 | °C |
| Storage Temperature Range (T_{STG}) for Epoxy coated | -40 to +125 | °C |
| Storage Temperature Range (T_{STG}) for Phenolic coated | -40 to +150 | °C |
| Temperature Coefficient (αV) of Clamping Voltage (V_C) at Specified Test Current | < 0.01 % | °C |
| Hi-Pot Encapsulation (Isolation Voltage Capability) for Epoxy coated | 2500 | V |
| Hi-Pot Encapsulation (Isolation Voltage Capability) for Phenolic coated | 500 | V |
| Epoxy Coating Insulation Resistance | >1,000 | MΩ |

CAUTION: Stresses above those listed in "Absolute Maximum Ratings" may cause permanent damage to the device. This is a stress only rating and operation of the device at these or any other conditions above those indicated in the operational sections of this specification is not implied.

AUMOV™ Varistor Series Device Ratings & Specifications

| Epoxy Coated Models | | Phenolic Coated Models | | Size Disc Dia. (mm) | Max Continuous Voltage | | Varistor Voltage at 1mA | | | Maximum Clamping Voltage | | Max Peak Current (8 x 20µs 1 pulse) | Energy Rating (2ms, 1 pulse) | Energy (Load Dump, 10 pulses)* | Jump Start DC V _{jump} (5 min) | Typical Capacitance f = 1MHz |
|-------------------------|----------|-------------------------|----------|---------------------|------------------------|---------------------|-------------------------|---------|---------|--------------------------|---------------------|-------------------------------------|------------------------------|--------------------------------|---|------------------------------|
| Part Number (Base part) | Branding | Part Number (Base part) | Branding | | V _{RMS} (V) | V _{DC} (V) | Min (V) | Nom (V) | Max (V) | V _C (V) | I _{PK} (A) | I _{TM} (A) | W _{TM} (J) | (J) | (V) | (pF) |
| V05E14AUTO | 5E14A | V05P14AUTO | 5P14A | 5 | 14 | 16 | 19.8 | 22 | 24.2 | 43 | 1 | 400 | 1 | 6 | 25 | 1100 |
| V07E14AUTO | 7E14A | V07P14AUTO | 7P14A | 7 | 14 | 16 | 19.8 | 22 | 24.2 | 43 | 2.5 | 800 | 2.2 | 12 | 25 | 2450 |
| V10E14AUTO | 10E14A | V10P14AUTO | 10P14A | 10 | 14 | 16 | 19.8 | 22 | 24.2 | 43 | 5 | 1500 | 5 | 25 | 25 | 4650 |
| V14E14AUTO | 14E14A | V14P14AUTO | 14P14A | 14 | 14 | 16 | 19.8 | 22 | 24.2 | 43 | 10 | 3000 | 10 | 50 | 25 | 10200 |
| V20E14AUTO | 20E14A | V20P14AUTO | 20P14A | 20 | 14 | 16 | 19.8 | 22 | 24.2 | 43 | 20 | 5000 | 28 | 100 | 25 | 22200 |
| V05E17AUTO | 5E17A | V05P17AUTO | 5P17A | 5 | 17 | 20 | 24.3 | 27 | 29.7 | 53 | 1 | 400 | 1.4 | 6 | 30 | 950 |
| V07E17AUTO | 7E17A | V07P17AUTO | 7P17A | 7 | 17 | 20 | 24.3 | 27 | 29.7 | 53 | 2.5 | 800 | 2.8 | 12 | 30 | 2100 |
| V10E17AUTO | 10E17A | V10P17AUTO | 10P17A | 10 | 17 | 20 | 24.3 | 27 | 29.7 | 53 | 5 | 1500 | 6.5 | 25 | 30 | 3900 |
| V14E17AUTO | 14E17A | V14P17AUTO | 14P17A | 14 | 17 | 20 | 24.3 | 27 | 29.7 | 53 | 10 | 3000 | 13 | 50 | 30 | 8700 |
| V20E17AUTO | 20E17A | V20P17AUTO | 20P17A | 20 | 17 | 20 | 24.3 | 27 | 29.7 | 53 | 20 | 5000 | 35 | 100 | 30 | 18750 |
| V05E25AUTO | 5E25A | V05P25AUTO | 5P25A | 5 | 25 | 28 | 35.1 | 39 | 42.9 | 77 | 1 | 400 | 2.5 | 6 | 40 | 750 |
| V07E25AUTO | 7E25A | V07P25AUTO | 7P25A | 7 | 25 | 28 | 35.1 | 39 | 42.9 | 77 | 2.5 | 800 | 5.5 | 12 | 40 | 1500 |
| V10E25AUTO | 10E25A | V10P25AUTO | 10P25A | 10 | 25 | 28 | 35.1 | 39 | 42.9 | 77 | 5 | 1500 | 13 | 25 | 40 | 2900 |
| V14E25AUTO | 14E25A | V14P25AUTO | 14P25A | 14 | 25 | 28 | 35.1 | 39 | 42.9 | 77 | 10 | 3000 | 25 | 50 | 40 | 6200 |
| V20E25AUTO | 20E25A | V20P25AUTO | 20P25A | 20 | 25 | 28 | 35.1 | 39 | 42.9 | 77 | 20 | 5000 | 77 | 100 | 40 | 13500 |
| V05E30AUTO | 5E30A | V05P30AUTO | 5P30A | 5 | 30 | 34 | 42.3 | 47 | 51.7 | 93 | 1 | 400 | 3.1 | 6 | 45 | 650 |
| V07E30AUTO | 7E30A | V07P30AUTO | 7P30A | 7 | 30 | 34 | 42.3 | 47 | 51.7 | 93 | 2.5 | 800 | 7 | 12 | 45 | 1350 |
| V10E30AUTO | 10E30A | V10P30AUTO | 10P30A | 10 | 30 | 34 | 42.3 | 47 | 51.7 | 93 | 5 | 1500 | 15.5 | 25 | 45 | 2550 |
| V14E30AUTO | 14E30A | V14P30AUTO | 14P30A | 14 | 30 | 34 | 42.3 | 47 | 51.7 | 93 | 10 | 3000 | 32 | 50 | 45 | 5550 |
| V20E30AUTO | 20E30A | V20P30AUTO | 20P30A | 20 | 30 | 34 | 42.3 | 47 | 51.7 | 93 | 20 | 5000 | 90 | 100 | 45 | 12000 |
| V05E42AUTO | 5E42A | V05P42AUTO | 5P42A | 5 | 42 | 50 | 61.2 | 68 | 74.8 | 135 | 1 | 400 | 5 | 6 | 55 | 500 |
| V07E42AUTO | 7E42A | V07P42AUTO | 7P42A | 7 | 42 | 50 | 61.2 | 68 | 74.8 | 135 | 2.5 | 800 | 11 | 12 | 55 | 1000 |
| V10E42AUTO | 10E42A | V10P42AUTO | 10P42A | 10 | 42 | 50 | 61.2 | 68 | 74.8 | 135 | 5 | 1500 | 25 | 25 | 55 | 1850 |
| V14E42AUTO | 14E42A | V14P42AUTO | 14P42A | 14 | 42 | 50 | 61.2 | 68 | 74.8 | 135 | 10 | 3000 | 50 | 50 | 55 | 4000 |
| V20E42AUTO | 20E42A | V20P42AUTO | 20P42A | 20 | 42 | 50 | 61.2 | 68 | 74.8 | 135 | 20 | 5000 | 140 | 100 | 55 | 8500 |

Note: 1. Average power dissipation of transients not to exceed 0.2W, 0.25W, 0.4W, 0.6W or 1W for model sizes 5mm, 7mm, 10mm, 14mm and 20mm, respectively.

*2. Energy rating (auto load dump) for impulse duration of 40ms minimum to one half of peak current, 60sec interval ISO7637-2 pulse 5a and ISO16750-2 Table 5A.

3. The shift of Vnom (Varistor Voltage) may be to +/-15% for Load dump or Jump Start test.

Current Energy and Power Dissipation Ratings

Figure 1A - Power Derating for Epoxy Coated

For applications exceeding 85°C ambient temperature, the peak surge current and energy ratings must be reduced as shown below.

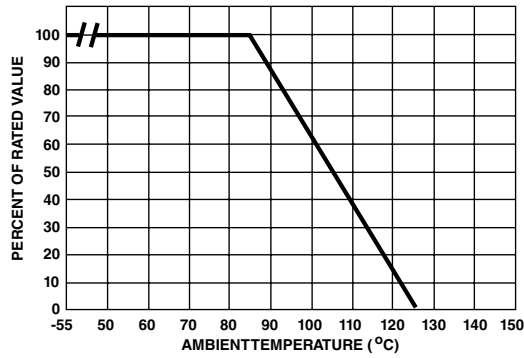

Figure 1B - Power Derating for Phenolic Coated

For applications exceeding 125°C ambient temperature, the peak surge current and energy ratings must be reduced as shown below.



Peak Pulse Current Test Waveform for Clamping Voltage



Figure 2: Peak Pulse Current Test Waveform for Clamping Voltage

- O_1 = Virtual Origin of Wave
- t = Time from 10% to 90% of Peak
- t_1 = Virtual Front Time = $1.25 \times t$
- t_2 = Virtual Time to Half-Value (Impulse Duration)

Example - For an 8/20 μ s Current Waveform:

- 8μ s = t_1 = Virtual Front Time
- 20μ s = t_2 = Virtual Time to Half-Value

Maximum Clamping Voltage for 5mm Parts

V05x14AUTO - V05x42AUTO

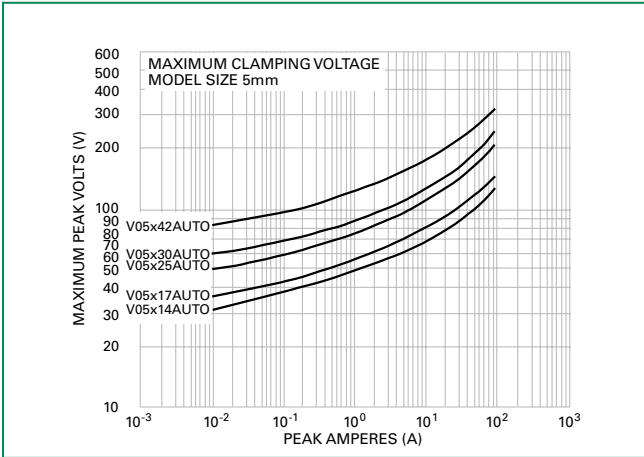

Maximum Clamping Voltage for 7mm Parts

V07x14AUTO - V07x42AUTO

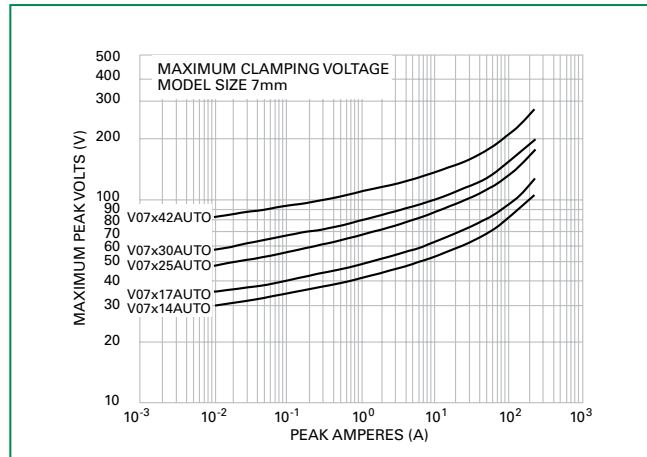

Maximum Clamping Voltage for 10mm Parts

V10x14AUTO - V10x42AUTO

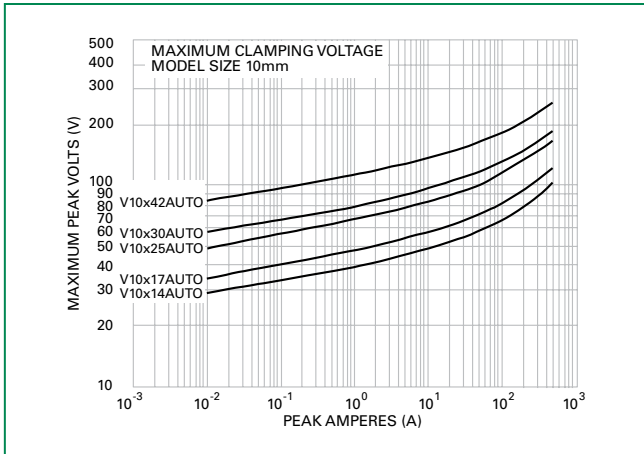

Maximum Clamping Voltage for 14mm Parts

V14x14AUTO - V14x42AUTO

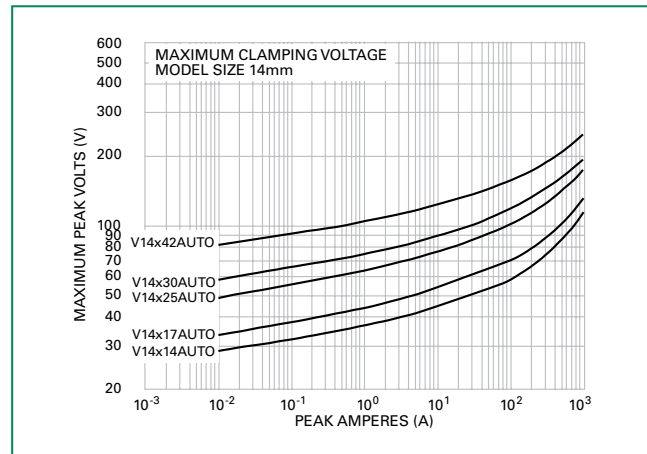

Maximum Clamping Voltage for 20mm Parts

V20x14AUTO - V20x42AUTO

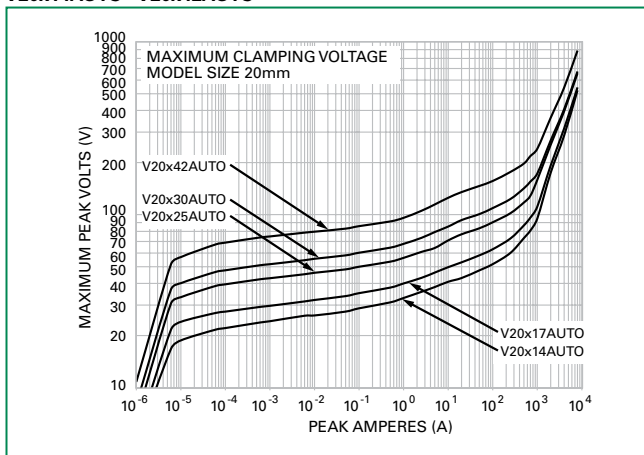

Repetitive Surge Capability for 5mm Parts

V05x14AUTO – V05x42AUTO



Repetitive Surge Capability for 7mm Parts

V07x14AUTO – V07x42AUTO



Repetitive Surge Capability for 10mm Parts

V10x14AUTO – V10x42AUTO



Repetitive Surge Capability for 14mm Parts

V14x14AUTO – V14x42AUTO



Repetitive Surge Capability for 20mm Parts

V020x14AUTO – V20x42AUTO



NOTE: If pulse ratings are exceeded, a shift of V_{NIDCI} (at specified current) of more than +/-10% could result. This type of shift, which normally results in a decrease of V_{NIDCI} , may result in the device not meeting the original published specifications, but does not prevent the device from continuing to function, and to provide ample protection.

Wave Solder Profile

Non Lead-free Profile



Lead-free Profile



Physical Specifications

| | |
|----------------------------------|---|
| Lead Material | Copper Clad Steel Wire |
| Soldering Characteristics | Solderability per MIL-STD-202, Method 208 |
| Insulating Material | Cured, flame retardant epoxy polymer meets UL94V-0 requirements |
| Device Labeling | Marked with LF, voltage and date code |

Environmental Specifications

| | |
|-----------------------------|--|
| Humidity Aging | +85°C, 85% RH, 1000 hours +/-10% typical voltage change |
| Thermal Shock | +85°C to -40°C 10 times +/-10% typical voltage change |
| Solvent Resistance | MIL-STD-202, Method 215 |
| Moisture Sensitivity | Level 1, J-STD-020 |

Product Dimensions (mm)

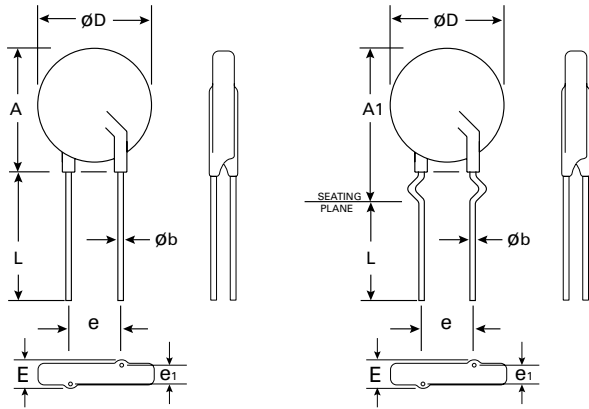

| Dimension | V _{RMS} Voltage Model | 5mm Size | | 7mm Size | | 10mm Size | | 14mm Size | | 20mm Size | |
|-------------------------|--------------------------------|------------------|------------------|------------------|------------------|-----------------|-----------------|-----------------|-----------------|-----------------|-----------------|
| | | Min. mm (in) | Max. mm (in) | Min. mm (in) | Max. mm (in) | Min. mm (in) | Max. mm (in) | Min. mm (in) | Max. mm (in) | Min. mm (in) | Max. mm (in) |
| A | All | - | 10 (0.394) | - | 12 (0.472) | - | 16 (0.630) | - | 20 (0.787) | - | 26.5 (1.043) |
| A1 | All | - | 13 (0.512) | - | 15 (0.591) | - | 19.5 (0.768) | - | 22.5 (0.886) | - | 29 (1.142) |
| ØD | All | - | 7 (0.276) | - | 9 (0.354) | - | 12.5 (0.492) | - | 17 (0.669) | - | 23 (0.906) |
| e | All | 4 (0.157) | 6 (0.236) | 4 (0.157) | 6 (0.236) | 6.5 (0.256) | 8.5 (0.335) | 6.5 (0.256) | 8.5 (0.335) | 6.5 (0.256) | 8.5 (0.335) |
| e₁ | 11 - 30 | 1 (0.039) | 3 (0.118) | 1 (0.039) | 3 (0.118) | 1 (0.039) | 3 (0.118) | 1 (0.039) | 3 (0.118) | 1 (0.039) | 3 (0.118) |
| | 35 - 40 | 1.5 (0.059) | 3.5 (0.138) | 1.5 (0.059) | 3.5 (0.138) | 1.5 (0.059) | 3.5 (0.138) | 1.5 (0.059) | 3.5 (0.138) | 1.5 (0.059) | 3.5 (0.138) |
| E | 11 - 30 | - | 5.0 (0.197) | - | 5.0 (0.197) | - | 5.0 (0.197) | - | 5.0 (0.197) | - | 5.0 (0.197) |
| | 35 - 40 | - | 5.6 (0.220) | - | 5.6 (0.220) | - | 5.6 (0.220) | - | 5.6 (0.220) | - | 5.6 (0.220) |
| Øb | All | 0.585 (0.023) | 0.685 (0.027) | 0.585 (0.023) | 0.685 (0.027) | 0.76 (0.030) | 0.86 (0.034) | 0.76 (0.030) | 0.86 (0.034) | 0.76 (0.030) | 0.86 (0.034) |
| L | All | 25.4 (1.00) | - | 25.4 (1.00) | - | 25.4 (1.00) | - | 25.4 (1.00) | - | 25.4 (1.00) | - |
| L_{TRIM} | All | 2.41 (0.095) | 4.69 (0.185) | 2.41 (0.095) | 4.69 (0.185) | 2.41 (0.095) | 4.69 (0.185) | 2.41 (0.095) | 4.69 (0.185) | 2.41 (0.095) | 4.69 (0.185) |

Tape and Reel Specifications

5 and 7mm Devices



10, 14 and 20mm Devices



Refer to next page for dimension measurement specifics.

Tape and Reel Specifications (continued)

NOTES:

- Radial devices on tape are supplied with crimped leads, straight leads, or under-crimped leads
- Leads are offset by product dimension e1
- Conforms to ANSI and EIA specifications
- Can be supplied to IEC Publication 286-2

| SYMBOL | DESCRIPTION | MODEL SIZE | | | | |
|----------------------|---|-------------------|-------------------|-------------------|-------------------|-------------------|
| | | 5mm | 7mm | 10mm | 14mm | 20mm |
| P | Pitch of Component | 12.7 +/- 1.0 | 12.7 +/- 1.0 | 25.4 +/- 1.0 | 25.4 +/- 1.0 | 25.4 +/- 1.0 |
| P₀ | Feed Hole Pitch | 12.7 +/- 0.2 | 12.7 +/- 0.2 | 12.7 +/- 0.2 | 12.7 +/- 0.2 | 12.7 +/- 0.2 |
| P₁ | Feed Hole Center to Pitch | 3.85 +/- 0.7 | 3.85 +/- 0.7 | 8.85 +/- 0.7 | 8.85 +/- 0.7 | 8.85 +/- 0.7 |
| P₂ | Hole Center to Component Center | 6.35 +/- 1.0 | 6.35 +/- 1.0 | 12.7 +/- 0.7 | 12.7 +/- 0.7 | 12.7 +/- 0.7 |
| F | Lead to Lead Distance | 5.0 +/- 1.0 | 5.0 +/- 1.0 | 7.5 +/- 1.0 | 7.5 +/- 1.0 | 7.5 +/- 1.0 |
| h | Component Alignment | 2.0 Max | 2.0 Max | 2.0 Max | 2.0 Max | 2.0 Max |
| W | Tape Width | 18.0 +1.0 / -0.5 | 18.0 +1.0 / -0.5 | 18.0 +1.0 / -0.5 | 18.0 +1.0 / -0.5 | 18.0 +1.0 / -0.5 |
| W₀ | Hold Down Tape Width | 12.0 +/- 0.3 | 12.0 +/- 0.3 | 12.0 +/- 0.3 | 12.0 +/- 0.3 | 12.0 +/- 0.3 |
| W₁ | Hole Position | 9.0 +0.75 / -0.50 | 9.0 +0.75 / -0.50 | 9.0 +0.75 / -0.50 | 9.0 +0.75 / -0.50 | 9.0 +0.75 / -0.50 |
| W₂ | Hold Down Tape Position | 0.5 Max | 0.5 Max | 0.5 Max | 0.5 Max | 0.5 Max |
| H | Height from Tape Center to Component Base | 18.0 +2.0 / -0.0 | 18.0 +2.0 / -0.0 | 18.0 +2.0 / -0.0 | 18.0 +2.0 / -0.0 | 18.0 +2.0 / -0.0 |
| H₀ | Seating Plane Height | 16.0 +/- 0.5 | 16.0 +/- 0.5 | 16.0 +/- 0.5 | 16.0 +/- 0.5 | 16.0 +/- 0.5 |
| H₁ | Component Height | 29.0 Max | 32.0 Max | 36.0 Max | 40.0 Max | 46.5 Max |
| D₀ | Feed Hole Diameter | 4.0 +/- 0.2 | 4.0 +/- 0.2 | 4.0 +/- 0.2 | 4.0 +/- 0.2 | 4.0 +/- 0.2 |
| t | Total Tape Thickness | 0.7 +/- 0.2 | 0.7 +/- 0.2 | 0.7 +/- 0.2 | 0.7 +/- 0.2 | 0.7 +/- 0.2 |
| U | Undercrimp Width | 8.0 Max | 8.0 Max | 8.0 Max | 8.0 Max | 8.0 Max |
| p | Component Alignment | 3° Max | 3° Max | 3° Max | 3° Max | 3° Max |

Part Numbering System

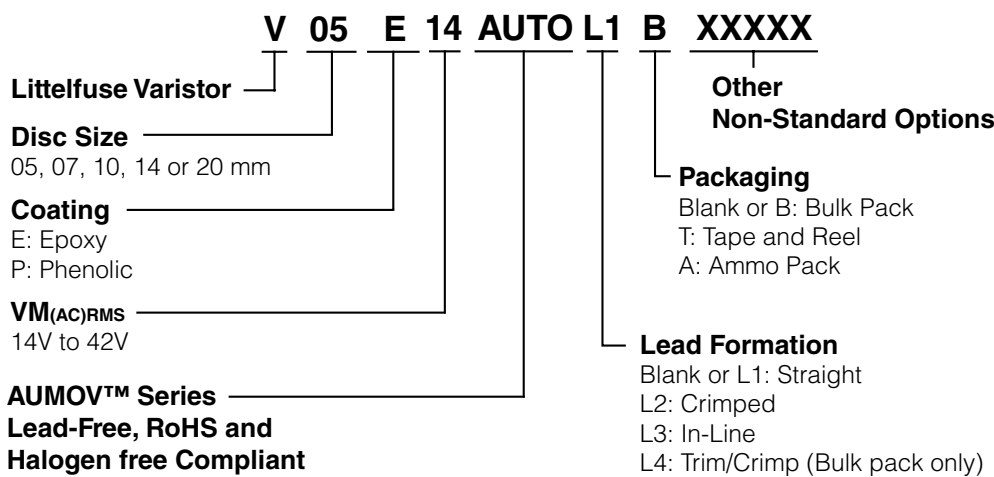



Компания «ЭлектроПласт» предлагает заключение долгосрочных отношений при поставках импортных электронных компонентов на взаимовыгодных условиях!

Наши преимущества:

- Оперативные поставки широкого спектра электронных компонентов отечественного и импортного производства напрямую от производителей и с крупнейших мировых складов;
- Поставка более 17-ти миллионов наименований электронных компонентов;
- Поставка сложных, дефицитных, либо снятых с производства позиций;
- Оперативные сроки поставки под заказ (от 5 рабочих дней);
- Экспресс доставка в любую точку России;
- Техническая поддержка проекта, помощь в подборе аналогов, поставка прототипов;
- Система менеджмента качества сертифицирована по Международному стандарту ISO 9001;
- Лицензия ФСБ на осуществление работ с использованием сведений, составляющих государственную тайну;
- Поставка специализированных компонентов (Xilinx, Altera, Analog Devices, Intersil, Interpoint, Microsemi, Aeroflex, Peregrine, Syfer, Eurofarad, Texas Instrument, Miteq, Cobham, E2V, MA-COM, Hittite, Mini-Circuits, General Dynamics и др.);

Помимо этого, одним из направлений компании «ЭлектроПласт» является направление «Источники питания». Мы предлагаем Вам помощь Конструкторского отдела:

- Подбор оптимального решения, техническое обоснование при выборе компонента;
- Подбор аналогов;
- Консультации по применению компонента;
- Поставка образцов и прототипов;
- Техническая поддержка проекта;
- Защита от снятия компонента с производства.



Как с нами связаться

Телефон: 8 (812) 309 58 32 (многоканальный)

Факс: 8 (812) 320-02-42

Электронная почта: org@eplast1.ru

Адрес: 198099, г. Санкт-Петербург, ул. Калинина, дом 2, корпус 4, литера А.