

IEC Appliance Inlet C14 with Filter, "Lock and Shield" Mounting



GRF4: with shield and line filter



See below:
[Approvals and Compliances](#)

Description

- Panel mount :
 Snap-in version from rear-side
- 3 Functions :
 Appliance Inlet Protection class I , with EMC-shield , Line filter in standard and medical version

Characteristics

- Time saving "Lock and Shield" snap-in design for rear-panel mounting
- All single elements are already wired
- Innovative EMC-shielding with flexible steel segments for an excellent contact to the panel
- Suitable for use in medical equipment according to IEC/UL 60601-1
 For applications according IEC/UL 62368-1 we recommend variants with bleed resistor

Other versions on request

- Panel thickness 1.2 mm and 2.0 mm

References

- Alternative: version without line filter [GRF2](#)
- Alternative: Standard version

Weblinks

- [pdf data sheet](#), [html datasheet](#), [General Product Information](#), [Approvals](#), [Distributor-Stock-Check](#), [Accessories](#), [Detailed request for product](#)

Technical Data

| | | | |
|---------------------------------|---|-------------------------|---|
| Ratings IEC | 0.5 - 10A @ Ta 40 °C / 250VAC; 50Hz | Appliance inlet/-outlet | C14 acc. to IEC 60320-1, UL 60320-1, CSA C22.2 no. 60320-1 (for cold conditions) pin-temperature 70 °C, 10A, Protection Class I |
| Ratings UL/CSA | 0.5 - 15A @ Ta 40 °C / 250VAC; 60Hz | Line Filter | Standard and Medical Version, IEC 60939, UL 1283, CSA C22.2 no. 8 Technical Details |
| Leakage Current | standard < 0.5mA (250 V / 60Hz) medical < 5 µA (250 V / 60 Hz) | MTBF | > 3'300'000h acc. to MIL-HB-217 F |
| Dielectric Strength | > 1.7kVDC between L-N > 2.7kVDC between L/N-PE Test voltage (2 sec) | | |
| Allowable Operation Temperature | -25 °C to 85 °C | | |
| Climatic Category | 25/085/21 acc. to IEC 60068-1 | | |
| IP-Protection | from front side IP40 acc. to IEC 60529 | | |
| Protection Class | Suitable for appliances with protection class I acc. to IEC 61140 | | |
| Terminal | Quick connect terminals 4.8 x 0.8 mm | | |
| Panel Thickness S | Screw Mounting screw torque max 0.5Nm Snap-in: 1.5 mm (other on request) | | |
| Material: Housing | Thermoplastic, black, UL 94V-0 | | |

Approvals and Compliances

Detailed information on product approvals, code requirements, usage instructions and detailed test conditions can be looked up in [Details about Approvals](#)

SCHURTER products are designed for use in industrial environments. They have approvals from independent testing bodies according to national and international standards. Products with specific characteristics and requirements such as required in the automotive sector according to IATF 16949, medical technology according to ISO 13485 or in the aerospace industry can be offered exclusively with customer-specific, individual agreements by SCHURTER.

Approvals







The approval mark is used by the testing authorities to certify compliance with the safety requirements placed on electronic products.

Approval Reference Type: GRF4

| Approval Logo | Certificates | Certification Body | Description |
|--|---------------|--------------------|--------------------------------|
|  | VDE Approvals | VDE | VDE Certificate Number: 102348 |
|  | UL Approvals | UL | UL File Number: E72928 |

Product standards

Product standards that are referenced

| Organization | Design | Standard | Description |
|--|-----------------------|-----------------------|---|
|  | Designed according to | IEC 60320-1 | Appliance couplers for household and similar general purposes |
|  | Designed according to | IEC 60939 | Passive filters for suppressing electromagnetic interference |
|  | Designed according to | IEC 61058-1 | Switches for appliances. Part 1. General requirements |
|  | Designed according to | UL 60320-1 | Standard for Attachment Plugs and Receptacles |
|  | Designed according to | UL 1283 | Electromagnetic interference filters |
|  | Designed according to | CSA C22.2 no. 60320-1 | General Use Receptacles, Attachment Plugs, and Similar Wiring Devices |
|  | Designed according to | CSA C22.2 no. 8 | Electromagnetic interference (EMI) filters |





Application standards

Application standards where the product can be used

| Organization | Design | Standard | Description |
|--|--------------------------------|----------------|--|
|  | Designed for applications acc. | IEC/UL 62368-1 | IEC 62368-1 includes the basic requirements for safety of audio, video, information technology and office equipment. |
|  | Designed for applications acc. | IEC 60601-1 | Medical electrical equipment - Part 1: General requirements for basic safety and essential performance |

Compliances

The product complies with following Guide Lines

| Identification | Details | Initiator | Description |
|--|------------------------------|-------------|---|
|  | CE declaration of conformity | SCHURTER AG | The CE marking declares that the product complies with the applicable requirements laid down in the harmonisation of Community legislation on its affixing in accordance with EU Regulation 765/2008. |
|  | RoHS | SCHURTER AG | Directive RoHS 2011/65/EU, Amendment (EU) 2015/863 |
|  | China RoHS | SCHURTER AG | The law SJ / T 11363-2006 (China RoHS) has been in force since 1 March 2007. It is similar to the EU directive RoHS. |
|  | REACH | SCHURTER AG | On 1 June 2007, Regulation (EC) No 1907/2006 on the Registration, Evaluation, Authorization and Restriction of Chemicals 1 (abbreviated as "REACH") entered into force. |
|  | Medical Technology | SCHURTER AG | Suitable for use in medical equipment according to IEC/UL 60601-1 |

Dimension [mm]

GRF4

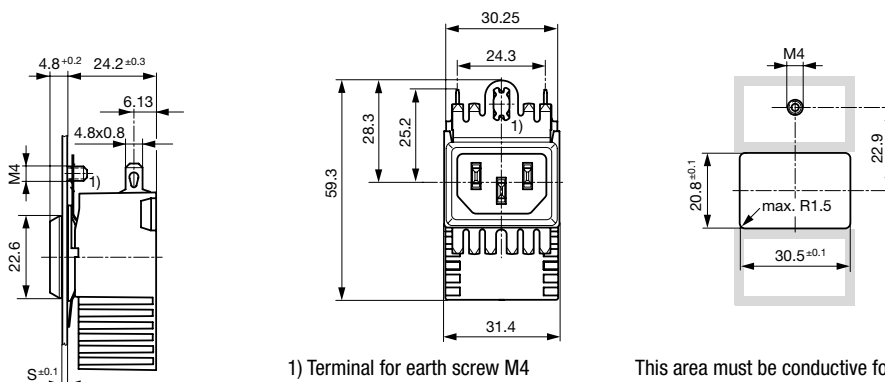

This area must be conductive for optimal shielding. Do not apply paint or coatings.

Assembly Instructions

Step 1

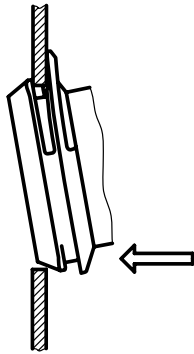

Place the socket in top edge of the panel cut-out.

Step 3

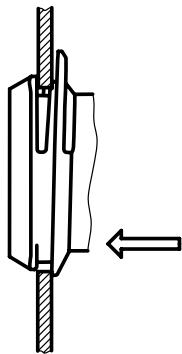

Push the socket forward into the panel cut-out.

Step 2



Push the socket upwards.

Step 4



Release the socket. The component is self adjusting.

Technical Data of Filter-Components

| Rated Current [A] | Filter-Type | Inductances L [mH] | Capacitance CX [nF] | Capacitance CY [nF] | R [MΩ] |
|-------------------|----------------------|--------------------|---------------------|---------------------|--------|
| 0.5 | Standard version | 2 x 24 | 100 | 2.2 | - |
| 1 | Standard version | 2 x 12 | 100 | 2.2 | - |
| 3 | Standard version | 2 x 2.5 | 100 | 2.2 | - |
| 6 | Standard version | 2 x 0.78 | 100 | 2.2 | - |
| 10 | Standard version | 2 x 0.225 | 100 | 2.2 | - |
| 15 | Standard version | 2 x 0.1 | 100 | 2.2 | - |
| 0.5 | Medical Version (M5) | 2 x 24 | 100 | - | 1 |
| 1 | Medical Version (M5) | 2 x 12 | 100 | - | 1 |
| 3 | Medical Version (M5) | 2 x 2.5 | 100 | - | 1 |
| 6 | Medical Version (M5) | 2 x 0.78 | 100 | - | 1 |
| 10 | Medical Version (M5) | 2 x 0.225 | 100 | - | 1 |
| 15 | Medical Version (M5) | 2 x 0.1 | 100 | - | 1 |

Diagrams

Standard version

Medical Version (M5)

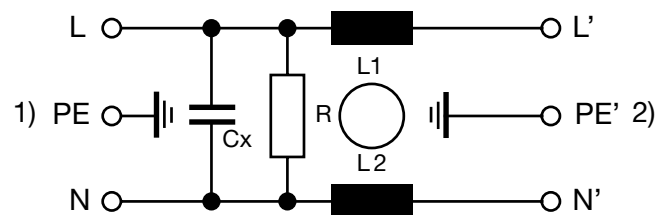
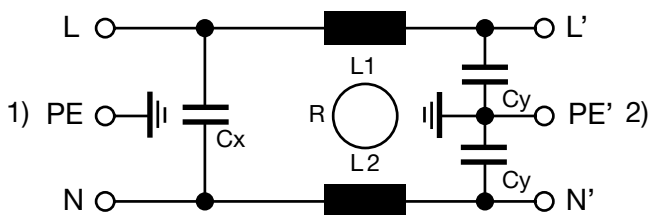

1) Line
2) Load

1) Line
2) Load

Attenuation Loss

--- 50Ω differential mode ___ 50Ω common mode

Standard version

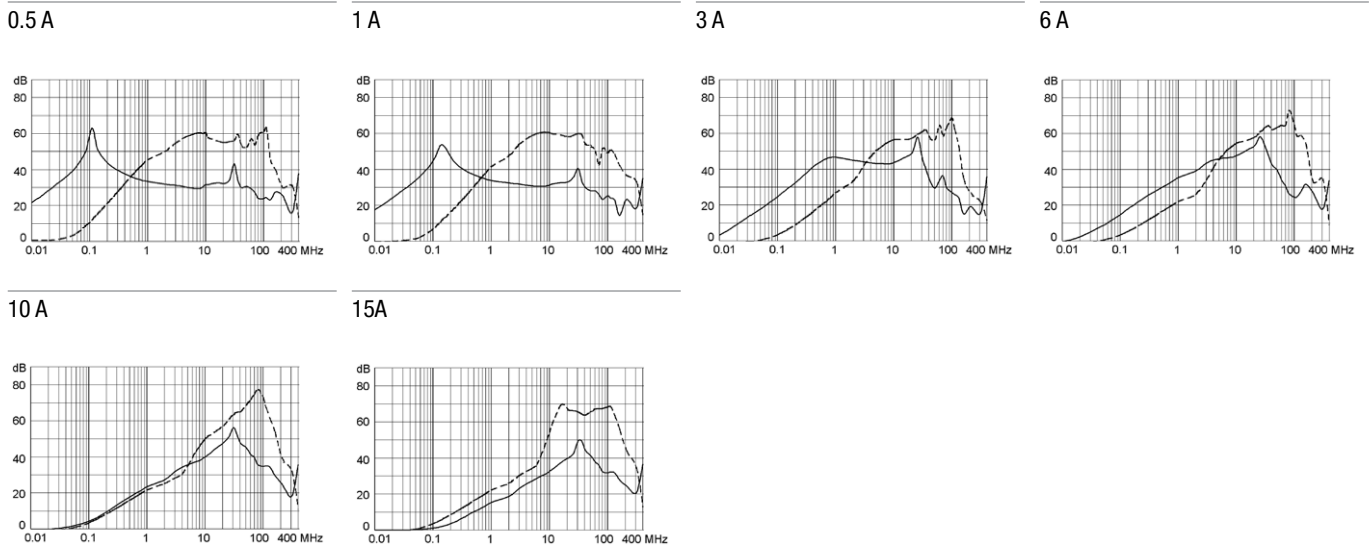

Medical version (M5)

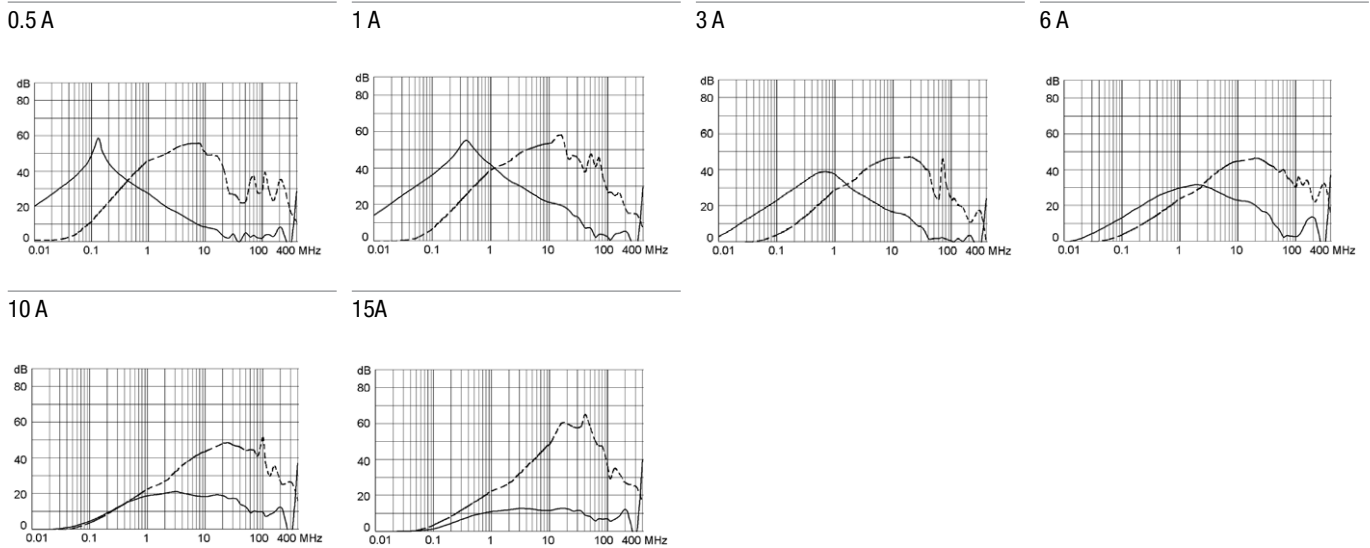

All Variants

| Rated Current IEC [A] | Rated Current UL [A] | Filter-Type | Panel Thickness s [mm] | Packaging unit | Order Number |
|-----------------------|----------------------|----------------------|------------------------|----------------|---------------------------------|
| 0.5 | 0.5 | Standard version | 1 | 20 | GRF4.0411.011.C |
| 1 | 1 | Standard version | 1 | 20 | GRF4.0412.011.C |
| 6 | 6 | Standard version | 1 | 20 | GRF4.0416.011.C |
| 10 | 10 | Standard version | 1 | 20 | GRF4.0417.011.C |
| 0.5 | 0.5 | Standard version | 1.5 | 20 | GRF4.0411.013.C |
| 1 | 1 | Standard version | 1.5 | 20 | GRF4.0412.013.C |
| 3 | 3 | Standard version | 1.5 | 20 | GRF4.0413.013.C |
| 6 | 6 | Standard version | 1.5 | 20 | GRF4.0416.013.C |
| 10 | 10 | Standard version | 1.5 | 20 | GRF4.0417.013.C |
| 15 | 15 | Standard version | 1.5 | 20 | GRF4.0419.013.C |
| 3 | 3 | Standard version | 2 | 20 | GRF4.0413.014.C |
| 0.5 | 0.5 | Medical Version (M5) | 1.5 | 20 | GRF4.0021.013.C |
| 1 | 1 | Medical Version (M5) | 1.5 | 20 | GRF4.0022.013.C |

| Rated Current IEC [A] | Rated Current UL [A] | Filter-Type | Panel Thickness [mm] | Packaging unit | Order Number |
|-----------------------|----------------------|----------------------|----------------------|----------------|-----------------|
| 3 | 3 | Medical Version (M5) | 1.5 | 20 | GRF4.0023.013.C |
| 6 | 6 | Medical Version (M5) | 1.5 | 20 | GRF4.0026.013.C |
| 10 | 10 | Medical Version (M5) | 1.5 | 20 | GRF4.0027.013.C |
| 15 | 15 | Medical Version (M5) | 1.5 | 20 | GRF4.0029.013.C |

Most Popular.

Availability for all products can be searched real-time: <https://www.schurter.com/en/Stock-Check/Stock-Check-SCHURTER>

Packaging unit 20 Pcs

Mating Outlets/Connectors

Category / Description

Appliance Outlet Overview complete



| | |
|---|------|
| 4787, Mounting: Screw-on mounting, Appliance Outlet: IEC Solder terminals, 10 A, Suitable for appliances with protection class I | 4787 |
| 4788, Mounting: Snap-in version, Appliance Outlet: IEC Solder terminals or quick connect terminals, 10 A, Suitable for appliances with protection class I | 4788 |
| IEC Appliance Outlet F or H, Screw-on Mounting, Front Side, Solder, PCB or Quick-connect Terminal | 5091 |

[Appliance Outlet further types to GRF4](#)

Connector Overview complete



| | |
|---|---------|
| 4782 Mounting: Power Cord, 3 x 1 mm ² / 3 x 18 AWG, Cable, Connector: IEC C13 | 4782 |
| 4785 Mounting: Power Cord, 3 x 1 mm ² / 3 x 18 AWG, Cable, Connector: IEC C13 | 4785 |
| 4012 Mounting: Power Supply Cord, 3 x 1 mm ² , Screw clamps, Connector: IEC C13 | 4012 |
| 4300-06 Mounting: Power Cord, 3 x 1 mm ² / 3 x 18 AWG, Cable, Connector: IEC C13 | 4300-06 |
| 4781 Mounting: Power Cord, 3 x 1 mm ² / 3 x 18 AWG, Cable, Connector: IEC C15 | 4781 |

[Connector further types to GRF4](#)



Компания «ЭлектроПласт» предлагает заключение долгосрочных отношений при поставках импортных электронных компонентов на взаимовыгодных условиях!

Наши преимущества:

- Оперативные поставки широкого спектра электронных компонентов отечественного и импортного производства напрямую от производителей и с крупнейших мировых складов;
- Поставка более 17-ти миллионов наименований электронных компонентов;
- Поставка сложных, дефицитных, либо снятых с производства позиций;
- Оперативные сроки поставки под заказ (от 5 рабочих дней);
- Экспресс доставка в любую точку России;
- Техническая поддержка проекта, помощь в подборе аналогов, поставка прототипов;
- Система менеджмента качества сертифицирована по Международному стандарту ISO 9001;
- Лицензия ФСБ на осуществление работ с использованием сведений, составляющих государственную тайну;
- Поставка специализированных компонентов (Xilinx, Altera, Analog Devices, Intersil, Interpoint, Microsemi, Aeroflex, Peregrine, Syfer, Eurofarad, Texas Instrument, Miteq, Cobham, E2V, MA-COM, Hittite, Mini-Circuits, General Dynamics и др.);

Помимо этого, одним из направлений компании «ЭлектроПласт» является направление «Источники питания». Мы предлагаем Вам помощь Конструкторского отдела:

- Подбор оптимального решения, техническое обоснование при выборе компонента;
- Подбор аналогов;
- Консультации по применению компонента;
- Поставка образцов и прототипов;
- Техническая поддержка проекта;
- Защита от снятия компонента с производства.



Как с нами связаться

Телефон: 8 (812) 309 58 32 (многоканальный)

Факс: 8 (812) 320-02-42

Электронная почта: org@eplast1.ru

Адрес: 198099, г. Санкт-Петербург, ул. Калинина, дом 2, корпус 4, литера А.