

WIZ140SR/WIZ145SR Datasheet

(Version 0.9)

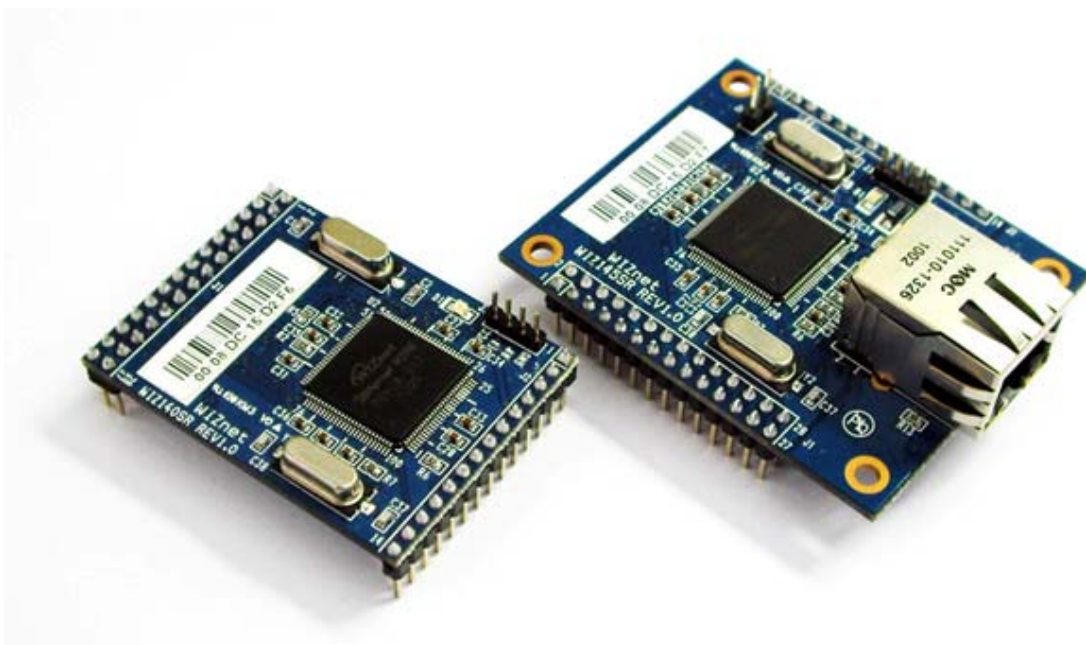

©2010 WIZnet Co., Ltd. All Rights Reserved.

☞ For more information, visit our website at <http://www.wiznet.co.kr>

Document Revision History

Date	Revision	Changes
2010-04-19	V0.9	Document release

COPYRIGHT NOTICE

Copyright 2010 WIZnet Co., Ltd. All Rights Reserved.

Technical Support: support@wiznet.co.kr

Sales & Distribution: sales@wiznet.co.kr

For more information, visit our website at <http://www.wiznet.co.kr>

Table of Contents

1. Introduction	1
1.1 Key Features.....	1
1.2 Product Specifications.....	2
1.3 WIZ140SR Module Interface.....	3
1.4 WIZ145SR Module Interface.....	4
1.5 WIZ140SR/WIZ145SR Test Board Interface.....	5
2. Hardware Specification	6
2.1 Hardware Dimension.....	6
2.1.1 WIZ140SR Module Dimension.....	6
2.1.2 WIZ145SR Module Dimension.....	7
2.2 Connector Specification	8
2.2.1 Pin Header Connector	8
2.2.2 RJ-45 Connector.....	10

Figures

FIGURE 1. WIZ140SR MODULE INTERFACE.....	3
FIGURE 2. WIZ145SR MODULE INTERFACE.....	4
FIGURE 3. WIZ140SR/WIZ145SR TEST BOARD INTERFACE	5
FIGURE 4. WIZ140SR MODULE DIMENSIONS	6
FIGURE 5. WIZ145SR MODULE DIMENSION	7
FIGURE 6. WIZ140SR MODULE PIN ASSIGN.....	8
FIGURE 7. WIZ145SR MODULE PIN ASSIGN.....	8
FIGURE 8. RJ-45 CONNECTOR.....	10

Tables

TABLE 1. WIZ140SR/WIZ145SR SPECIFICATIONS	2
TABLE 2. J1 CONNECTOR PIN DESCRIPTIONS	9
TABLE 3. J2 CONNECTOR PIN DESCRIPTIONS	10

1. Introduction

1.1 Key Features

- Direct Connection to Serial Devices
 - Adds Network Function Simply and Quickly
 - Provides Firmware Customization
- Supports 4 Ports Serial
- Provides System Stability and Reliability by using W5300 Hardware Chip
- Includes Configuration tool Program
- Supports Password for the Security
- Support Serial Configuration – with Simple and Easy command
- 10/100 Ethernet Interface and max 115,200bps Serial Interface
- Support Static IP, DHCP
- Support DNS Function
- RoHS Compliant

1.2 Product Specifications

Table 1. WIZ140SR/WIZ145SR Specifications

		WIZ140SR	WIZ145SR
Architecture	MCU	ARM-based 32-bit MCU	
	TCP/IP	W5300	
	PHY	Included in W5300 10/100Mbps Ethernet Auto negotiation (Full-duplex and Half-duplex) Auto MDI/MDIX	
	Serial	RS-232C	
Serial Data Port	Interface	TTL	
	Signals	TXD, RXD, RTS, CTS, GND	
	Parameters	Parity : None, Odd, Even Data bits : 7, 8 bit Flow control : None, RTS / CTS, XON / XOFF	
	Speed	Up to 115,200bps	
Serial Debug Port	Interface	TTL	
	Signals	TXD, RXD	
	Parameters	Parity : None Data bits : 8 bit Flow control : None	
	Speed	115,200bps	
Dimensions (Include connector size)		48.26mm x 35.56mm x 16.2mm	48.26mm x 61.4mm x 24.7mm
Pin header Connector		2.54mm Pitch Pin-header, 14Pin (1x14) 2.54mm Pitch Pin-header, 28Pin (2x14)	
RJ-45 Connector		None	1 RJ-45 Connector
Input voltage		DC 3.3V	
Power consumption		Under 200mA	
Temperature		0°C ~ 70°C (Operation), -40°C ~ 85°C (Storage)	
Humidity		10 ~ 80%	

1.3 WIZ140SR Module Interface

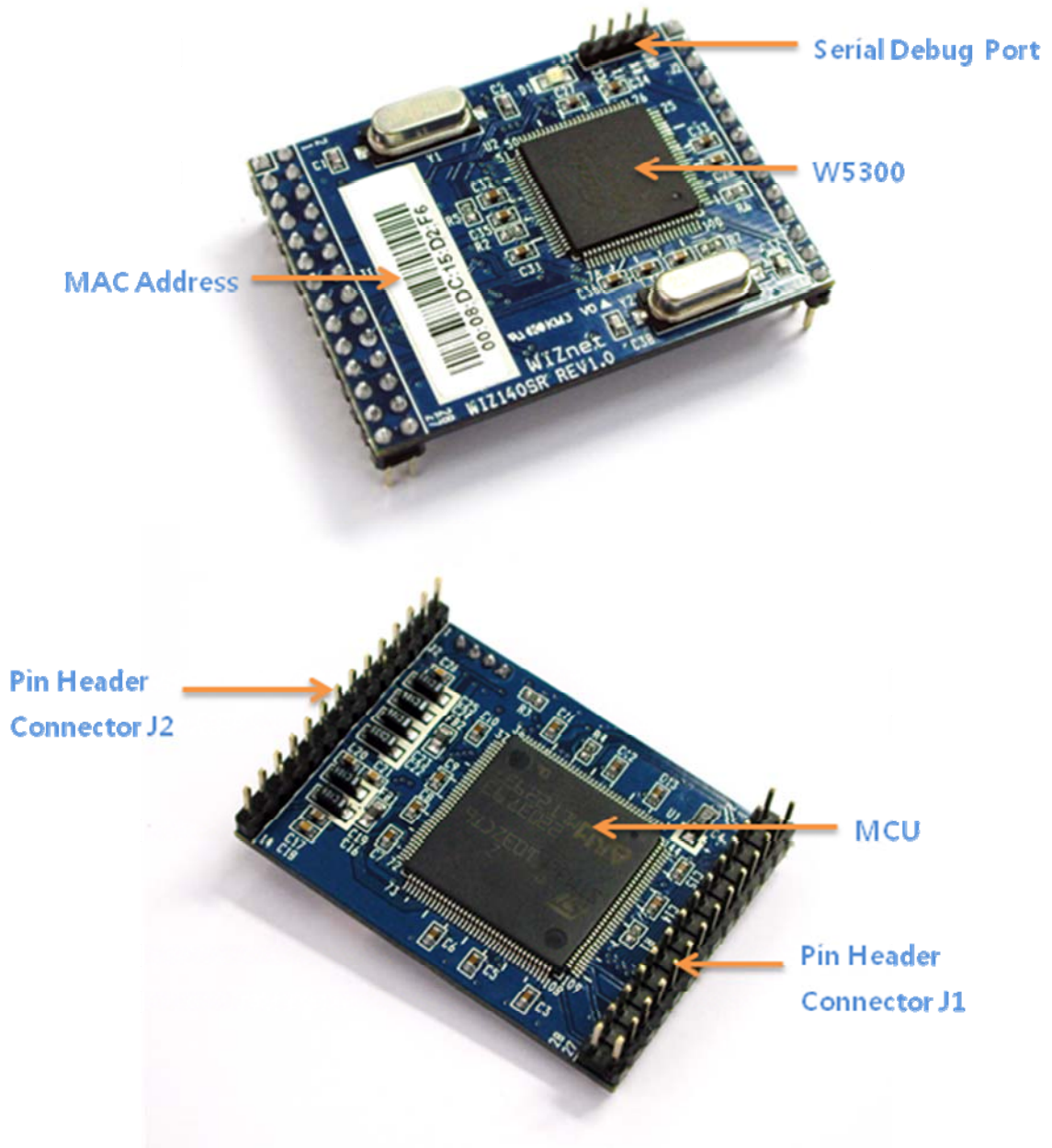

Figure 1. WIZ140SR Module Interface

1.4 WIZ145SR Module Interface

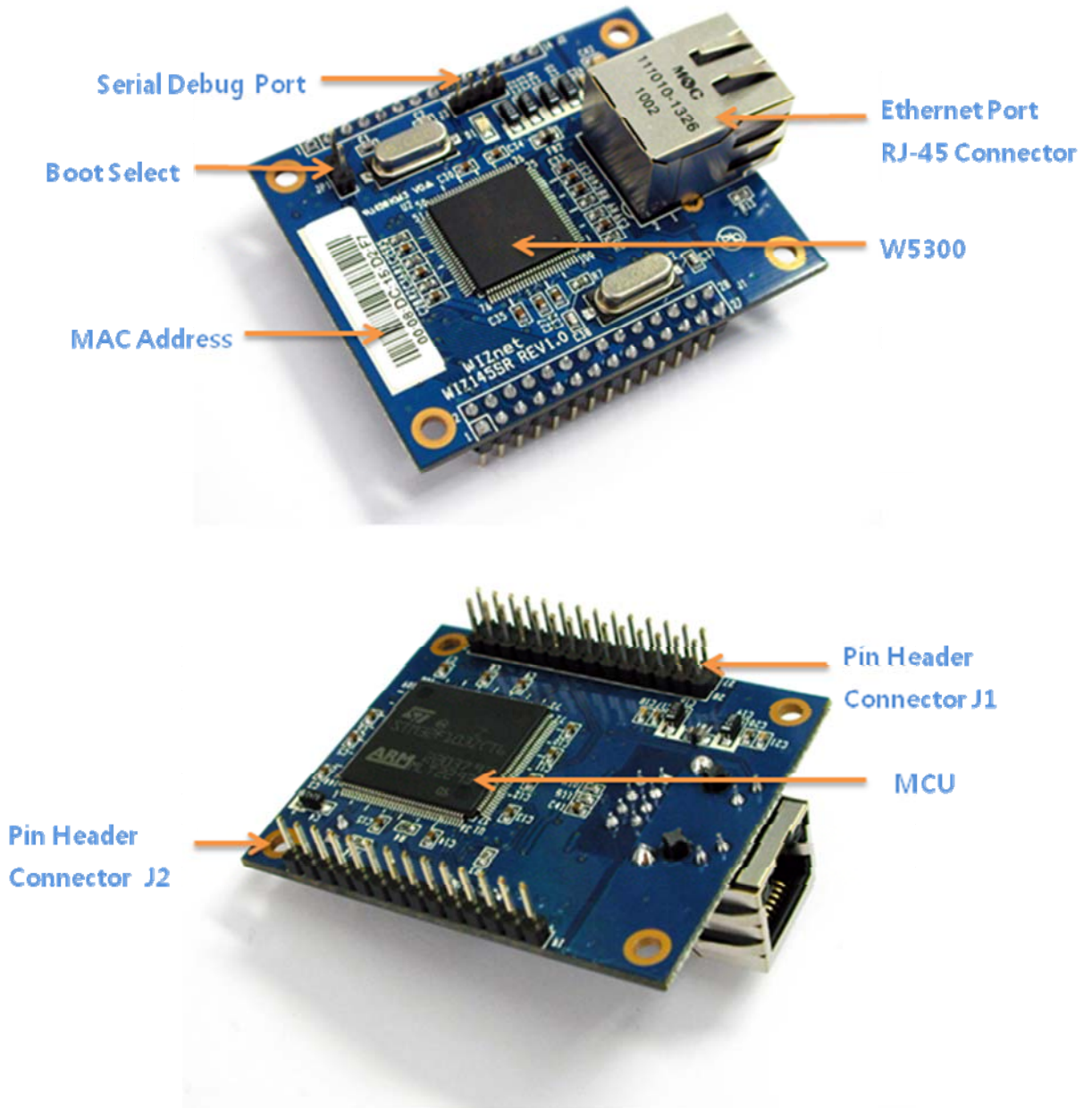

Figure 2. WIZ145SR Module Interface

1.5 WIZ140SR/WIZ145SR Test Board Interface

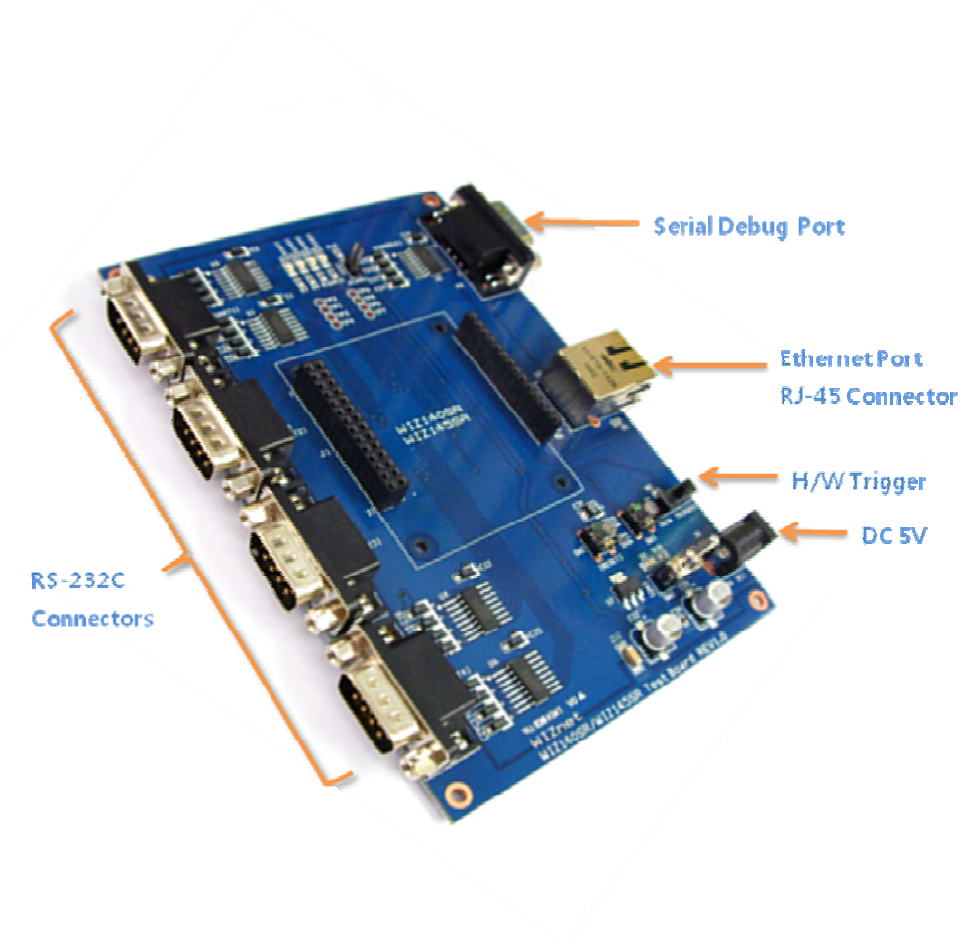

Figure 3. WIZ140SR/WIZ145SR Test Board Interface

2. Hardware Specification

2.1 Hardware Dimension

2.1.1 WIZ140SR Module Dimension

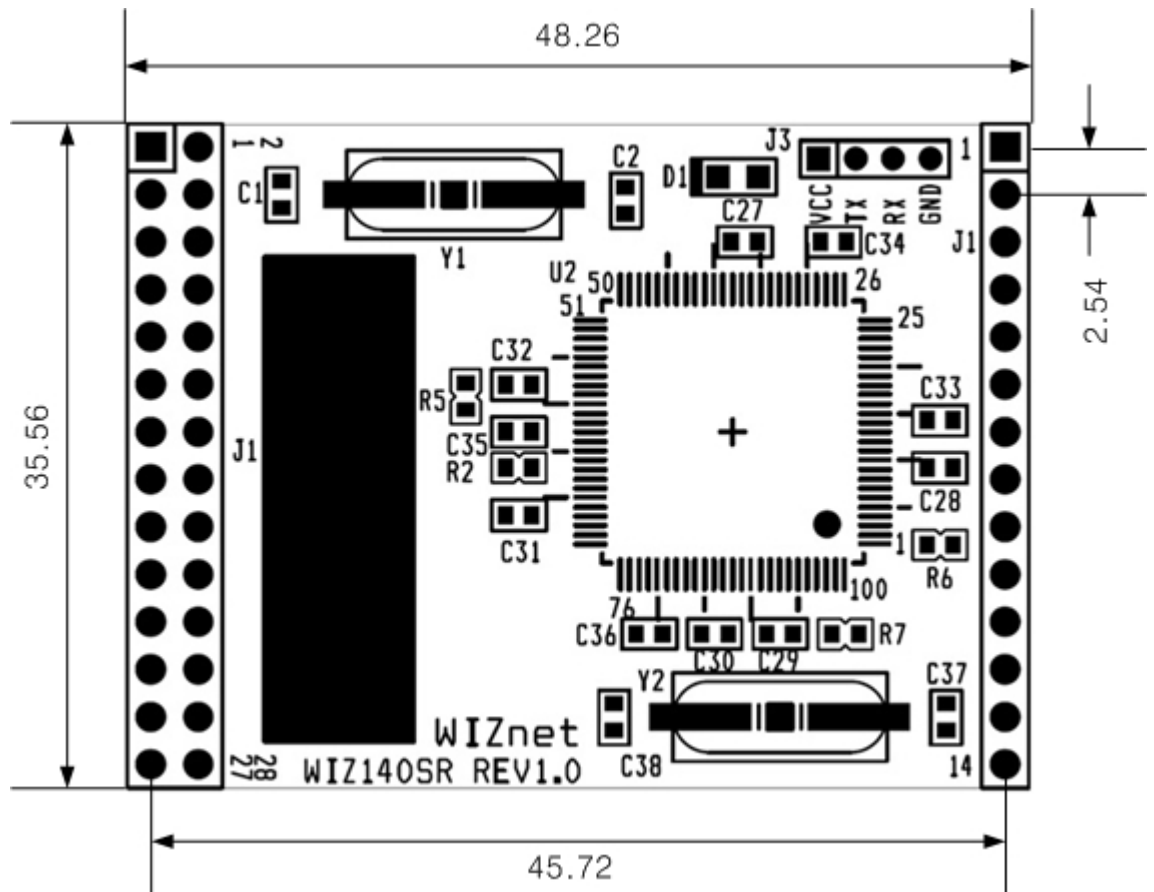

Figure 4. WIZ140SR Module Dimensions (mm)

2.1.2 WIZ145SR Module Dimension

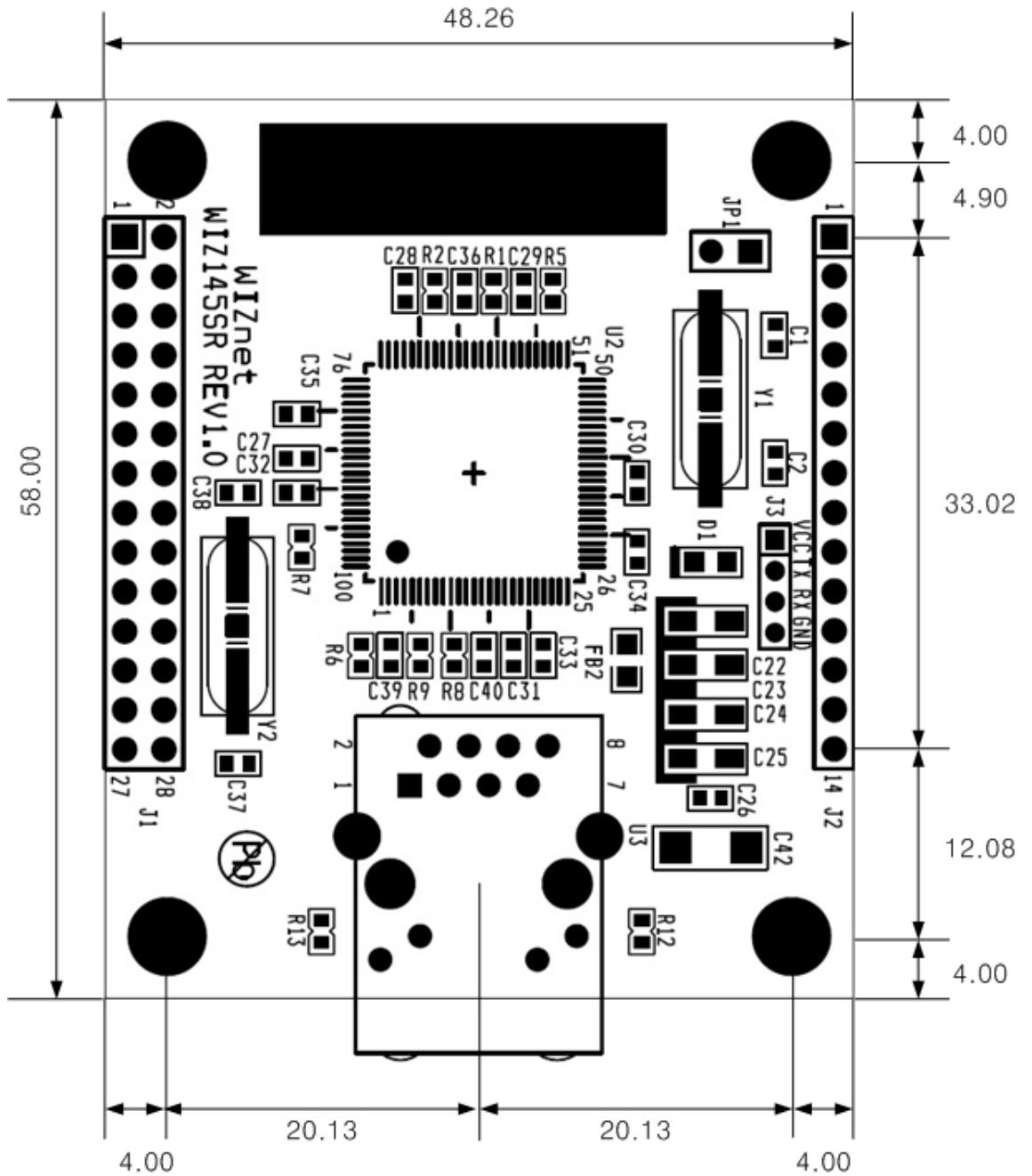

Figure 5. WIZ145SR Module Dimension (mm)

2.2 Connector Specification

2.2.1 Pin Header Connector

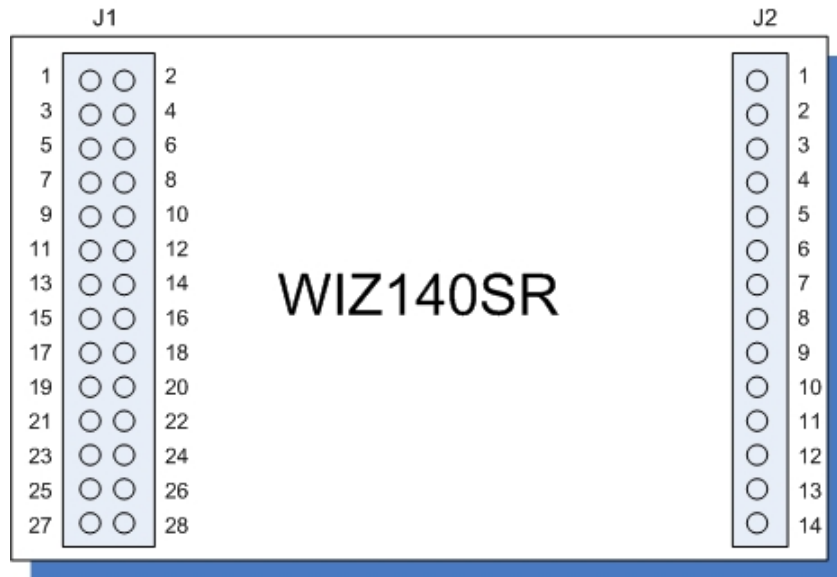

Figure 6. WIZ140SR Module Pin Assign

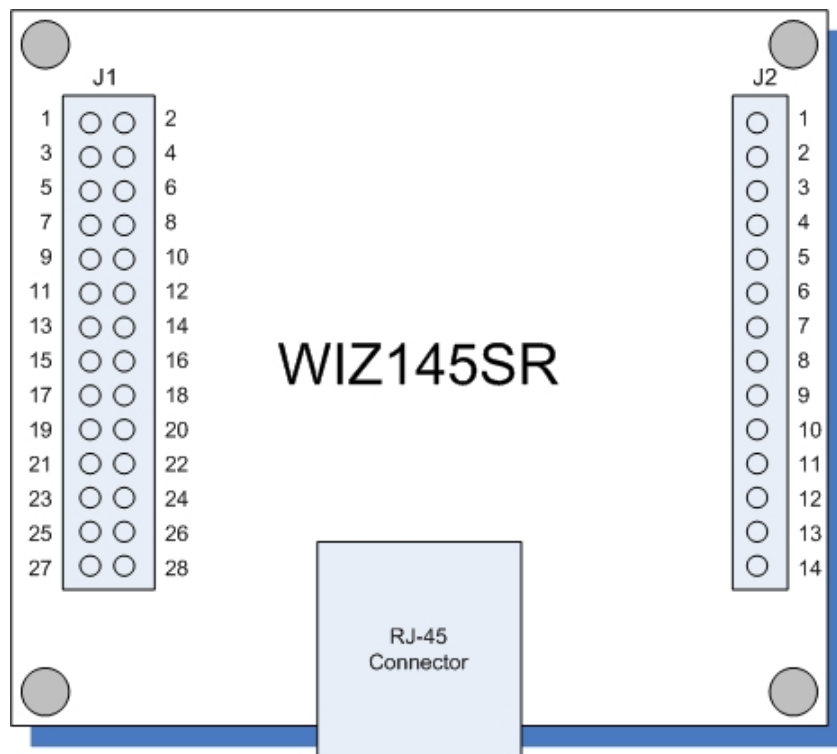

Figure 7. WIZ145SR Module Pin Assign

Table 2. J1 Connector Pin Descriptions

Pins	Signal	I/O	Description
1	3.3V VCC	S	3.3V Power
2	3.3V VCC	S	3.3V Power
3	/RESET	I	Board Reset, Active low
4	GND	S	Ground
5	UART1_RX	I	RS-232 Data Input for UART CH #1
6	UART1_CTS	I	RS-232 Clear To Send for UART CH #1
7	UART1_TX	O	RS-232 Data Output for UART CH #1
8	UART1_RTS	O	RS-232 Request To Send for UART CH #1
9	STATUS_1	O	Status signal for UART CH #1 Low: Connected, High: Not Connected
10	GND	S	Ground
11	UART2_RX	I	RS-232 Data Input for UART CH #2
12	UART2_CTS	I	RS-232 Clear To Send for UART CH #2
13	UART2_TX	O	RS-232 Data Output for UART CH #2
14	UART2_RTS	O	RS-232 Request To Send for UART CH #2
15	STATUS_2	O	Status signal for UART CH #2 Low: Connected, High: Not Connected
16	GND	S	Ground
17	UART3_RX	I	RS-232 Data Input for UART CH #3
18	UART3_CTS	I	RS-232 Clear To Send for UART CH #3
19	UART3_TX	O	RS-232 Data Output for UART CH #3
20	UART3_RTS	O	RS-232 Request To Send for UART CH #3
21	STATUS_3	O	Status signal for UART CH #3 Low: Connected, High: Not Connected
22	GND	S	Ground
23	UART4_RX	I	RS-232 Data Input for UART CH #4
24	UART4_CTS	I	RS-232 Clear To Send for UART CH #4
25	UART4_TX	O	RS-232 Data Output for UART CH #4
26	UART4_RTS	O	RS-232 Request To Send for UART CH #4
27	STATUS_4	O	Status signal for UART CH #4 Low: Connected, High: Not Connected
28	GND	S	Ground

Table 3. J2 Connector Pin Descriptions

Pins	Signal	I/O	Description
1	SW_INPUT	I	SW3 Switch Input
2	HW_TRIGGER	I	Serial Command Hardware Trigger
3	UART0_TX	O	RS-232 Data Output for Debugging Port
4	UART0_RX	I	RS-232 Data Input for Debugging Port
5	BOOT	I	Boot Selection Signal Low: Application Boot, High: MCU boot loader
6	TPTX-	O	Ethernet Differential Output - (WIZ140SR Only)
7	TPTX+	O	Ethernet Differential Output + (WIZ140SR Only)
8	PWFBOUT	S	Power Feedback Out
9	GND	S	Ground
10	TPRX-	I	Ethernet Differential Input - (WIZ140SR Only)
11	TPRX+	I	Ethernet Differential Input + (WIZ140SR Only)
12	GND	S	Ground
13	/LINK_LED	O	Link LED (WIZ140SR Only)
14	/ACT_LED	O	Active LED (WIZ140SR Only)

1. I=input, O = output, S = supply.
2. J2 Pin6,7,10,11,13,14 use only WIZ140SR. WIZ145SR has RJ-45 Connector on the module.

2.2.2 RJ-45 Connector

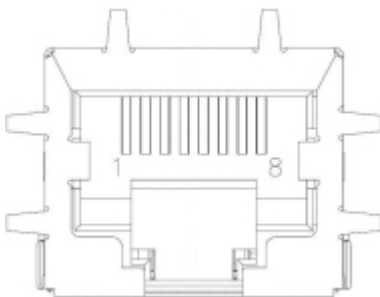

Pins	Signals
1	TX+
2	TX-
3	RX+
6	RX-

Figure 8. RJ-45 Connector



Компания «ЭлектроПласт» предлагает заключение долгосрочных отношений при поставках импортных электронных компонентов на взаимовыгодных условиях!

Наши преимущества:

- Оперативные поставки широкого спектра электронных компонентов отечественного и импортного производства напрямую от производителей и с крупнейших мировых складов;
- Поставка более 17-ти миллионов наименований электронных компонентов;
- Поставка сложных, дефицитных, либо снятых с производства позиций;
- Оперативные сроки поставки под заказ (от 5 рабочих дней);
- Экспресс доставка в любую точку России;
- Техническая поддержка проекта, помощь в подборе аналогов, поставка прототипов;
- Система менеджмента качества сертифицирована по Международному стандарту ISO 9001;
- Лицензия ФСБ на осуществление работ с использованием сведений, составляющих государственную тайну;
- Поставка специализированных компонентов (Xilinx, Altera, Analog Devices, Intersil, Interpoint, Microsemi, Aeroflex, Peregrine, Syfer, Eurofarad, Texas Instrument, Miteq, Cobham, E2V, MA-COM, Hittite, Mini-Circuits, General Dynamics и др.);

Помимо этого, одним из направлений компании «ЭлектроПласт» является направление «Источники питания». Мы предлагаем Вам помощь Конструкторского отдела:

- Подбор оптимального решения, техническое обоснование при выборе компонента;
- Подбор аналогов;
- Консультации по применению компонента;
- Поставка образцов и прототипов;
- Техническая поддержка проекта;
- Защита от снятия компонента с производства.



Как с нами связаться

Телефон: 8 (812) 309 58 32 (многоканальный)

Факс: 8 (812) 320-02-42

Электронная почта: org@eplast1.ru

Адрес: 198099, г. Санкт-Петербург, ул. Калинина, дом 2, корпус 4, литера А.