

FEATURES

Designed and guaranteed for 210°C operation

Low noise

1 nV/ $\sqrt{\text{Hz}}$ input noise

45 nV/ $\sqrt{\text{Hz}}$ output noise

High CMRR

126 dB CMRR (minimum), $G = 100$

80 dB CMRR (minimum) to 5 kHz, $G = 1$

Excellent ac specifications

15 MHz bandwidth ($G = 1$)

1.2 MHz bandwidth ($G = 100$)

22 V/ μs slew rate

THD: -130 dBc (1 kHz, $G = 1$)

Versatile

± 4 V to ± 17 V dual supply

Gain set with single resistor ($G = 1$ to 1000)

Specified temperature range

-40°C to $+210^\circ\text{C}$, SBDIP package

-40°C to $+175^\circ\text{C}$, SOIC package

APPLICATIONS

Down-hole instrumentation

Harsh environment data acquisition

Exhaust gas measurements

Vibration analysis

GENERAL DESCRIPTION

The AD8229 is an ultralow noise instrumentation amplifier designed for measuring small signals in the presence of large common-mode voltages and high temperatures.

The AD8229 has been designed for high temperature operation. The process is dielectrically isolated to avoid leakage currents at high temperatures. The design architecture was chosen to compensate for the low V_{BE} voltages at high temperatures.

The AD8229 excels at measuring tiny signals. It delivers industry leading 1 nV/ $\sqrt{\text{Hz}}$ input noise performance. The high CMRR of the AD8229 prevents unwanted signals from corrupting the acquisition. The CMRR increases as the gain increases, offering high rejection when it is most needed.

The AD8229 is one of the fastest instrumentation amplifiers available. Its current feedback architecture provides high

FUNCTIONAL BLOCK DIAGRAM

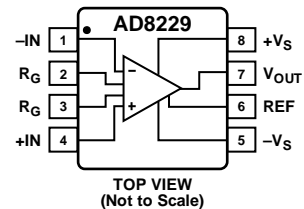

Figure 1.

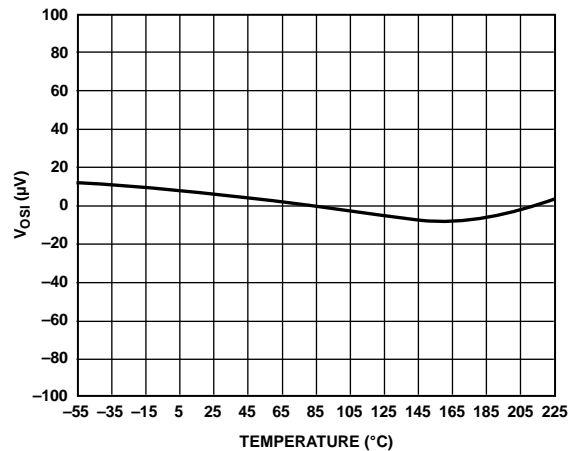

Figure 2. Typical Input Offset vs. Temperature ($G = 100$)

bandwidth at high gain, for example, 1.2 MHz at $G = 100$. The design includes circuitry to improve settling time after large input voltage transients. The AD8229 was designed for excellent distortion performance, allowing use in demanding applications such as vibration analysis.

Gain is set from 1 to 1000 with a single resistor. A reference pin allows the user to offset the output voltage. This feature can be useful when interfacing with analog-to-digital converters.

For the most demanding applications, the AD8229 is available in an 8-lead side-braced ceramic dual in-line package (SBDIP). For space-constrained applications, the AD8229 is available in an 8-lead plastic standard small outline package (SOIC).

Rev. B

Information furnished by Analog Devices is believed to be accurate and reliable. However, no responsibility is assumed by Analog Devices for its use, nor for any infringements of patents or other rights of third parties that may result from its use. Specifications subject to change without notice. No license is granted by implication or otherwise under any patent or patent rights of Analog Devices. Trademarks and registered trademarks are the property of their respective owners.

TABLE OF CONTENTS

Features	1	Theory of Operation	17
Applications.....	1	Architecture	17
Functional Block Diagram	1	Gain Selection	17
General Description	1	Reference Terminal	17
Revision History	2	Input Voltage Range.....	18
Specifications.....	3	Layout	18
Absolute Maximum Ratings.....	6	Input Bias Current Return Path	19
Predicted Lifetime vs. Operating Temperature	6	Input Protection	19
Thermal Resistance	6	Radio Frequency Interference (RFI).....	19
ESD Caution.....	6	Calculating the Noise of the Input Stage.....	20
Pin Configuration and Function Descriptions.....	7	Outline Dimensions	21
Typical Performance Characteristics	8	Ordering Guide	21

REVISION HISTORY

2/12—Rev. A to Rev. B

Added 8-Lead SOIC	Universal
Changes to Features Section and General Description Section.....	1
Changes to Table 1	3
Changes to Table 2, Thermal Resistance Section, and Table 3 ...	6
Updated Outline Dimensions	21
Changes to Ordering Guide	21

9/11—Rev. 0 to Rev. A

Changes to Features Section and General Description Section.....	1
Changes to Table 2.....	6
Added Predicted Lifetime vs. Operating Temperature Section and Figure 3; Renumbered Sequentially	6
Changes to Figure 18 and Figure 19.....	10
Changes to Figure 24 to Figure 28.....	11
Changes to Figure 29 and Figure 30.....	12
Changes to Figure 48.....	15
Changes to Figure 56.....	17
Changes to Power Supplies Section.....	18

1/11—Revision 0: Initial Version

SPECIFICATIONS

+V_S = 15 V, -V_S = -15 V, V_{REF} = 0 V, T_A = 25°C, G = 1, R_L = 10 kΩ, unless otherwise noted.

Table 1.

Parameter	Test Conditions/Comments	Min	Typ	Max	Unit
COMMON-MODE REJECTION RATIO (CMRR)					
CMRR DC to 60 Hz with 1 kΩ Source Imbalance	V _{CM} = ±10 V				
G = 1		86			dB
Temperature Drift	T _A = -40°C to +210°C			300	nV/V/°C
G = 10		106			dB
Temperature Drift	T _A = -40°C to +210°C			30	nV/V/°C
G = 100		126			dB
Temperature Drift	T _A = -40°C to +210°C			3	nV/V/°C
G = 1000	T _A = -40°C to +210°C	134			dB
CMRR at 5 kHz	V _{CM} = ±10 V				
G = 1		80			dB
G = 10		90			dB
G = 100		90			dB
G = 1000		90			dB
VOLTAGE NOISE					
Spectral Density ¹ : 1 kHz	V _{IN+} , V _{IN-} = 0 V				
Input Voltage Noise, e _{ni}			1	1.1	nV/√Hz
Output Voltage Noise, e _{no}			45	50	nV/√Hz
Peak to Peak: 0.1 Hz to 10 Hz					
G = 1			2		μV p-p
G = 1000			100		nV p-p
CURRENT NOISE					
Spectral Density: 1 kHz			1.5		pA/√Hz
Peak to Peak: 0.1 Hz to 10 Hz			100		pA p-p
VOLTAGE OFFSET					
Input Offset, V _{OSI}	V _{OS} = V _{OSI} + V _{OSO} /G			100	μV
Average TC	T _A = -40°C to +210°C		0.1	1	μV/°C
Output Offset, V _{OSO}				1000	μV
Average TC	T _A = -40°C to +210°C		3	10	μV/°C
Offset RTI vs. Supply (PSR)	V _S = ±5 V to ±15 V				
G = 1	T _A = -40°C to +210°C	86			dB
G = 10	T _A = -40°C to +210°C	106			dB
G = 100	T _A = -40°C to +210°C	126			dB
G = 1000	T _A = -40°C to +210°C	130			dB
INPUT CURRENT					
Input Bias Current				70	nA
High Temperature	T _A = 210°C			200	nA
Input Offset Current				35	nA
High Temperature	T _A = 210°C			50	nA

Parameter	Test Conditions/Comments	Min	Typ	Max	Unit
DYNAMIC RESPONSE					
Small Signal Bandwidth –3 dB					
G = 1			15		MHz
G = 10			4		MHz
G = 100			1.2		MHz
G = 1000			0.15		MHz
Settling Time 0.01%	10 V step				
G = 1			0.75		μs
G = 10			0.65		μs
G = 100			0.85		μs
G = 1000			5		μs
Settling Time 0.001%	10 V step				
G = 1			0.9		μs
G = 10			0.9		μs
G = 100			1.2		μs
G = 1000			7		μs
Slew Rate					
G = 1 to 100			22		V/μs
THD (FIRST FIVE HARMONICS)					
G = 1	f = 1 kHz, R _L = 2 kΩ, V _{OUT} = 10 V p-p		-130		dBc
G = 10			-116		dBc
G = 100			-113		dBc
G = 1000			-111		dBc
THD + Noise	f = 1 kHz, R _L = 2 kΩ, V _{OUT} = 10 V p-p, G = 100		0.0005		%
GAIN²					
Gain Range	G = 1 + (6 kΩ/R _G)	1		1000	V/V
Gain Error	V _{OUT} = ±10 V				
G = 1			0.01	0.03	%
G = 10			0.05	0.3	%
G = 100			0.05	0.3	%
G = 1000			0.1	0.3	%
Gain Nonlinearity	V _{OUT} = –10 V to +10 V				
G = 1 to 1000	R _L = 10 kΩ		2		ppm
Gain vs. Temperature					
G = 1	T _A = –40°C to +210°C		2	5	ppm/°C
G > 10	T _A = –40°C to +210°C			–100	ppm/°C
INPUT					
Impedance (Pin to Ground) ³			1.5 3		GΩ pF
Input Operating Voltage Range ⁴	V _S = ±5 V to ±18 V for dual supplies	–V _S + 2.8		+V _S – 2.5	V
Over Temperature	T _A = –40°C to +210°C	–V _S + 2.8		+V _S – 2.5	V
OUTPUT					
Output Swing, R _L = 2 kΩ		–V _S + 1.9		+V _S – 1.5	V
High Temperature, SBDIP package	T _A = 210°C	–V _S + 1.1		+V _S – 1.1	V
High Temperature, SOIC package	T _A = 175°C	–V _S + 1.2		+V _S – 1.1	V
Output Swing, R _L = 10 kΩ		–V _S + 1.8		+V _S – 1.2	V
High Temperature, SBDIP package	T _A = 210°C	–V _S + 1.1		+V _S – 1.1	V
High Temperature, SOIC package	T _A = 175°C	–V _S + 1.2		+V _S – 1.1	V
Short-Circuit Current			35		mA

Parameter	Test Conditions/Comments	Min	Typ	Max	Unit	
REFERENCE INPUT						
R_{IN}	$V_{IN+}, V_{IN-} = 0\text{ V}$		10		k Ω	
I_{IN}			70		μA	
Voltage Range		$-V_S$		$+V_S$	V	
Reference Gain to Output				1		V/V
Reference Gain Error				0.01		%
POWER SUPPLY						
Operating Range		± 4		± 17	V	
Quiescent Current			6.7	7	mA	
High Temperature, SBDIP package	$T_A = 210^\circ\text{C}$			12	mA	
High Temperature, SOIC package	$T_A = 175^\circ\text{C}$			11	mA	
TEMPERATURE RANGE						
For Specified Performance ⁵						
SBDIP package		-40		$+210$	$^\circ\text{C}$	
SOIC package		-40		$+175$	$^\circ\text{C}$	

¹ Total Voltage Noise = $\sqrt{(e_{ni})^2 + (e_{no}/G)^2 + e_{RG}^2}$. See the Theory of Operation section for more information.

² These specifications do not include the tolerance of the external gain setting resistor, R_G . For $G > 1$, R_G errors should be added to the specifications given in this table.

³ Differential and common-mode input impedance can be calculated from the pin impedance: $Z_{DIFF} = 2(Z_{PIN})$; $Z_{CM} = Z_{PIN}/2$.

⁴ Input voltage range of the AD8229 input stage only. The input range can depend on the common-mode voltage, differential voltage, gain, and reference voltage. See the Input Voltage Range section for more details.

⁵ For the guaranteed operation time at the maximum specified temperature, refer to the Predicted Lifetime vs. Operating Temperature section.

ABSOLUTE MAXIMUM RATINGS

Table 2.

Parameter	Rating
Supply Voltage	±17 V
Output Short-Circuit Current Duration	Indefinite
Maximum Voltage at -IN, +IN ¹	±V _S
Differential Input Voltage ¹	
Gain ≤ 4	±V _S
4 > Gain > 50	±50 V/gain
Gain ≥ 50	±1 V
Maximum Voltage at REF	±V _S
Storage Temperature Range	-65°C to +150°C
Specified Temperature Range	
SBDIP	-40°C to +210°C
SOIC	-40°C to +175°C
Maximum Junction Temperature	
SBDIP	245°C
SOIC	200°C
ESD	
Human Body Model	4 kV
Charge Device Model	1.5 kV
Machine Model	200 V

¹For voltages beyond these limits, use input protection resistors. See the Theory of Operation section for more information.

Stresses above those listed under Absolute Maximum Ratings may cause permanent damage to the device. This is a stress rating only; functional operation of the device at these or any other conditions above those indicated in the operational section of this specification is not implied. Exposure to absolute maximum rating conditions for extended periods may affect device reliability.

PREDICTED LIFETIME VS. OPERATING TEMPERATURE

Comprehensive reliability testing is performed on the AD8229. Product lifetimes at extended operating temperature are obtained using high temperature operating life (HTOL). Lifetimes are predicted from the Arrhenius equation, taking into account potential design and manufacturing failure mechanism assumptions. HTOL is performed to JEDEC JESD22-A108. A minimum of three wafer fab and assembly lots are processed through HTOL at the maximum operating temperature. Comprehensive reliability testing is performed on all Analog Devices, Inc., high temperature (HT) products.

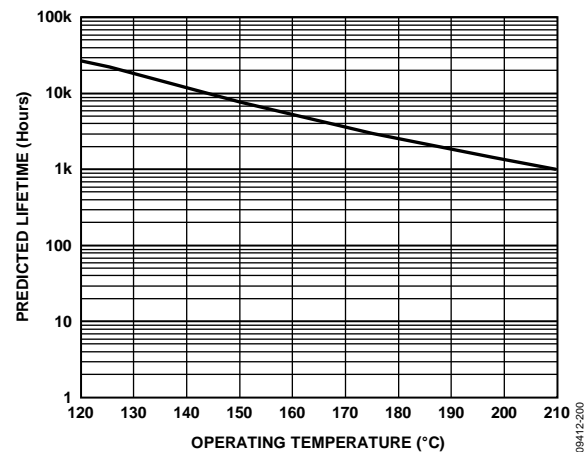

Figure 3. Predicted Lifetime vs. Operating Temperature

Refer to the [AD8229 Predicted Lifetime vs. Operating Temperature](#) document for the most up-to-date reliability data.

THERMAL RESISTANCE

θ_{JA} is specified for a device in free air using a 4-layer JEDEC printed circuit board (PCB).

Table 3.

Package Type	θ_{JA}	Unit
8-Lead SBDIP	100	°C/W
8-Lead SOIC	121	°C/W

ESD CAUTION



ESD (electrostatic discharge) sensitive device. Charged devices and circuit boards can discharge without detection. Although this product features patented or proprietary protection circuitry, damage may occur on devices subjected to high energy ESD. Therefore, proper ESD precautions should be taken to avoid performance degradation or loss of functionality.

PIN CONFIGURATION AND FUNCTION DESCRIPTIONS

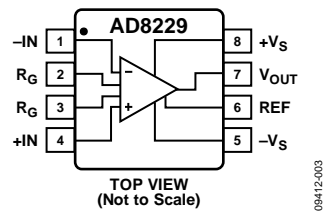

Figure 4. Pin Configuration

Table 4. Pin Function Descriptions

Pin No.	Mnemonic	Description
1	-IN	Negative Input Terminal.
2, 3	R _G	Gain Setting Terminals. Place resistor across the R _G pins to set the gain. $G = 1 + (6 \text{ k}\Omega/R_G)$.
4	+IN	Positive Input Terminal.
5	-V _S	Negative Power Supply Terminal.
6	REF	Reference Voltage Terminal. Drive this terminal with a low impedance voltage source to level-shift the output.
7	V _{OUT}	Output Terminal.
8	+V _S	Positive Power Supply Terminal.

TYPICAL PERFORMANCE CHARACTERISTICS

T = 25°C, V_S = ±15, V_{REF} = 0, R_L = 2 kΩ, unless otherwise noted.

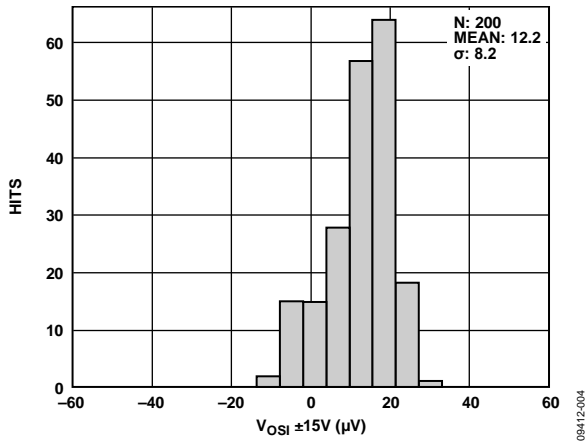

Figure 5. Typical Distribution of Input Offset Voltage

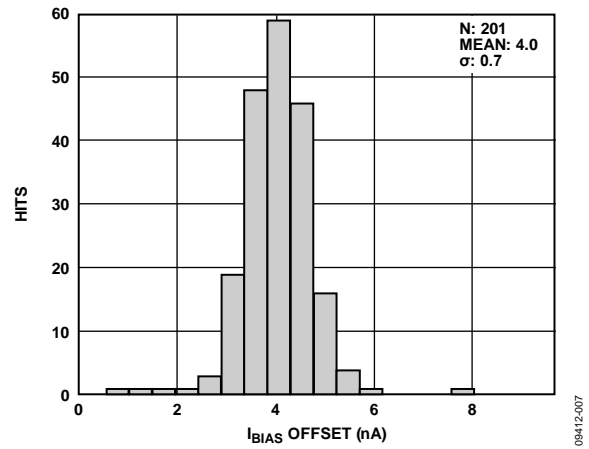

Figure 8. Typical Distribution of Input Bias Current

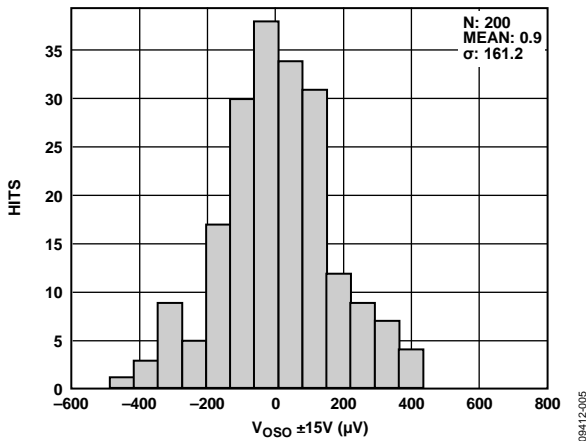

Figure 6. Typical Distribution of Output Offset Voltage

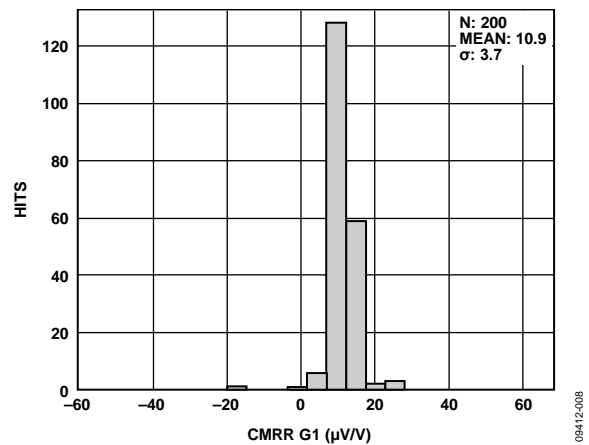

Figure 9. Typical Distribution of Common Mode Rejection, G = 1

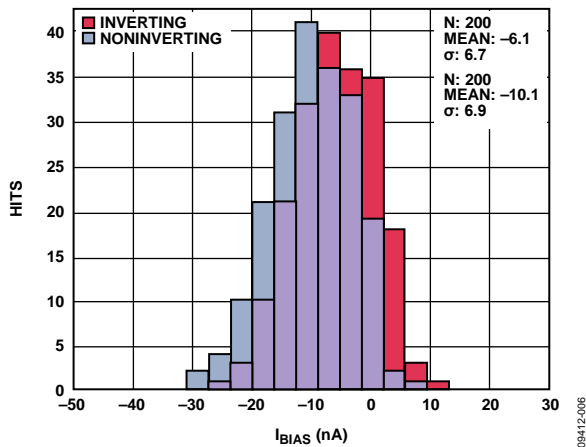

Figure 7. Typical Distribution of Input Bias Current

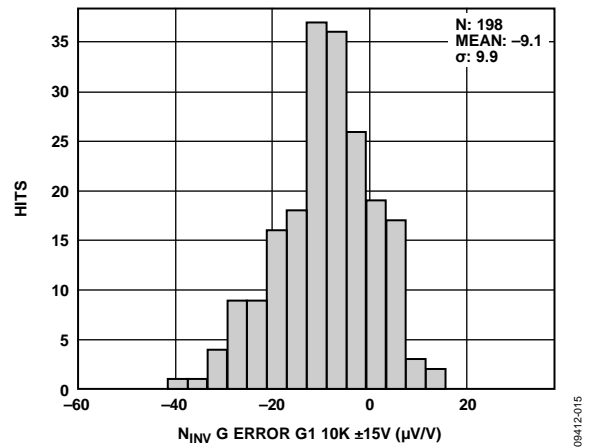

Figure 10. Typical Distribution of Gain Error, G = 1

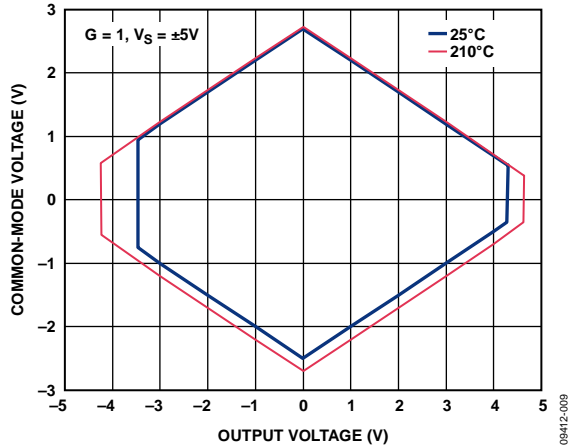

Figure 11. Input Common-Mode Voltage vs. Output Voltage, Dual Supply, $V_S = \pm 5V$; $G = 1$

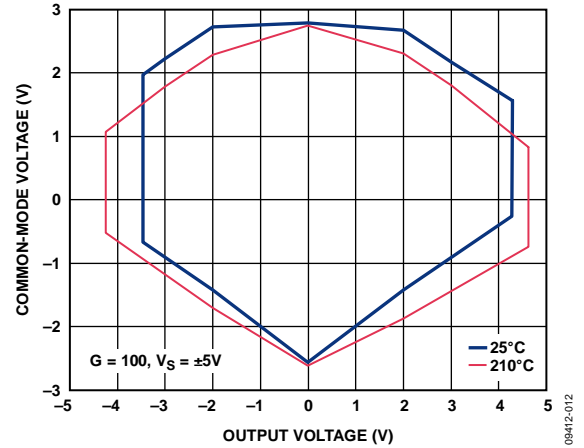

Figure 14. Input Common-Mode Voltage vs. Output Voltage, Dual Supply, $V_S = \pm 5V$; $G = 100$

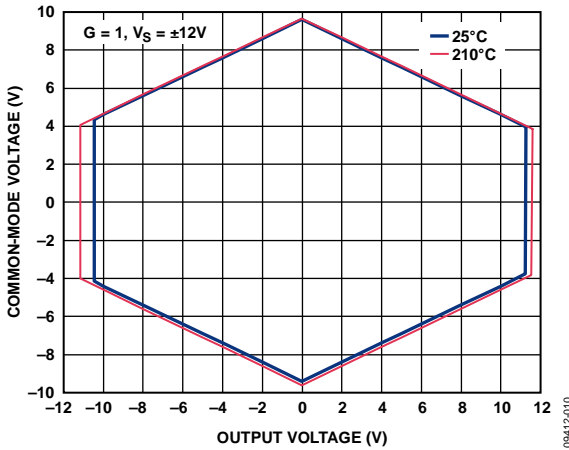

Figure 12. Input Common-Mode Voltage vs. Output Voltage, Dual Supply, $V_S = \pm 12V$; $G = 1$

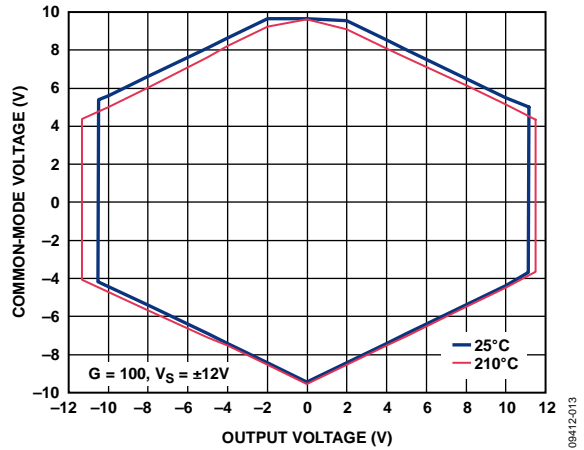

Figure 15. Input Common-Mode Voltage vs. Output Voltage, Dual Supply, $V_S = \pm 12V$; $G = 100$

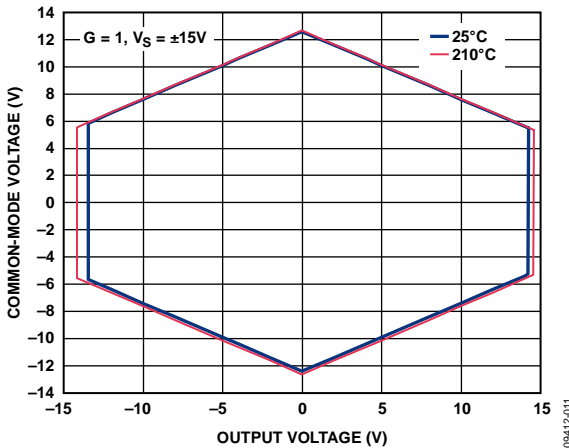

Figure 13. Input Common-Mode Voltage vs. Output Voltage, Dual Supply, $V_S = \pm 15V$; $G = 1$

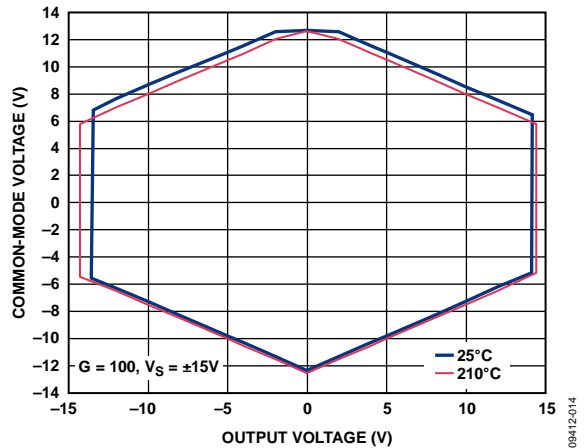

Figure 16. Input Common-Mode Voltage vs. Output Voltage, Dual Supply, $V_S = \pm 15V$; $G = 100$

09412-009

09412-012

09412-010

09412-013

09412-011

09412-014

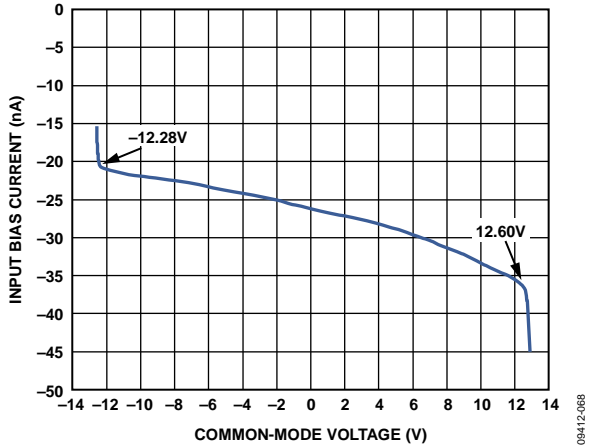

Figure 17. Input Bias Current vs. Common-Mode Voltage

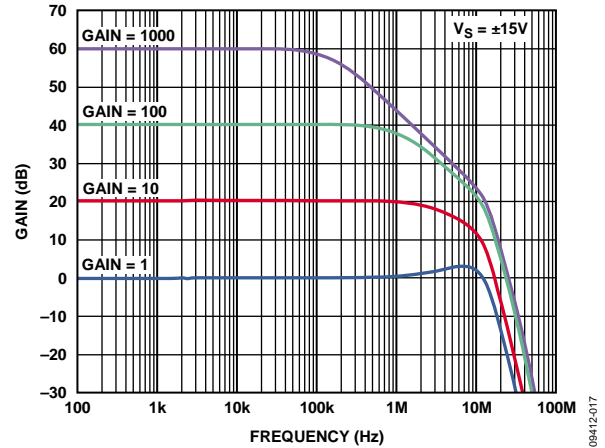

Figure 20. Gain vs. Frequency

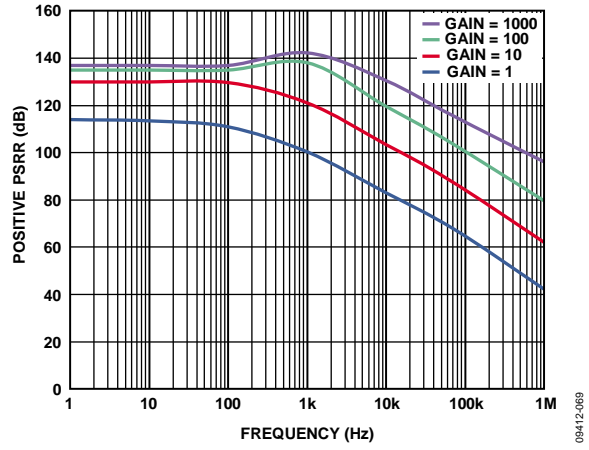

Figure 18. Positive PSRR vs. Frequency

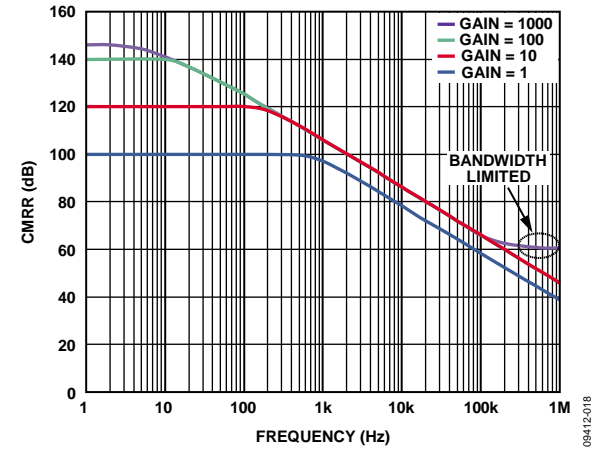

Figure 21. CMRR vs. Frequency

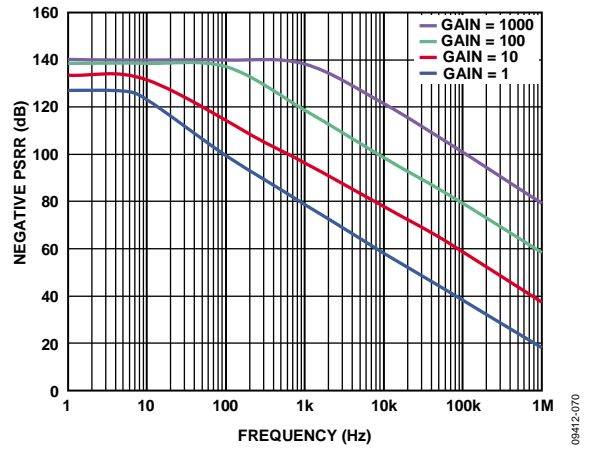

Figure 19. Negative PSRR vs. Frequency

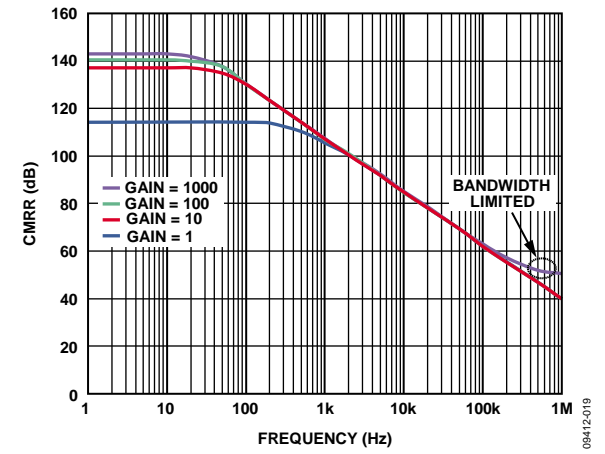

Figure 22. CMRR vs. Frequency, 1 kΩ Source Imbalance

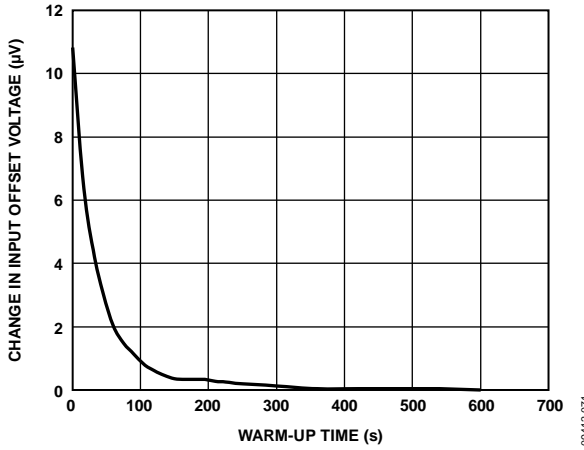

Figure 23. Change in Input Offset Voltage (V_{OS}) vs. Warm-Up Time

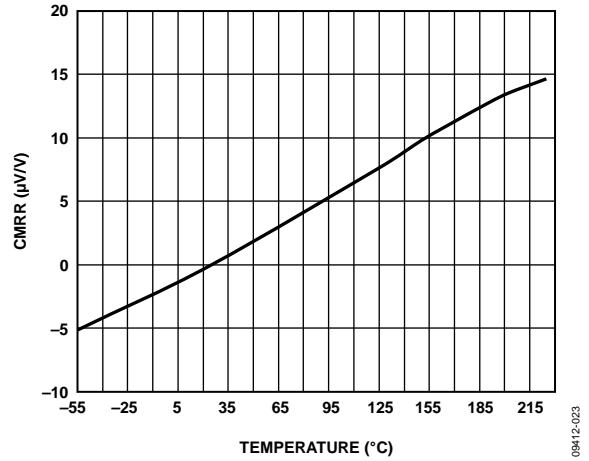

Figure 26. CMRR vs. Temperature, $G = 1$, Normalized at 25°C

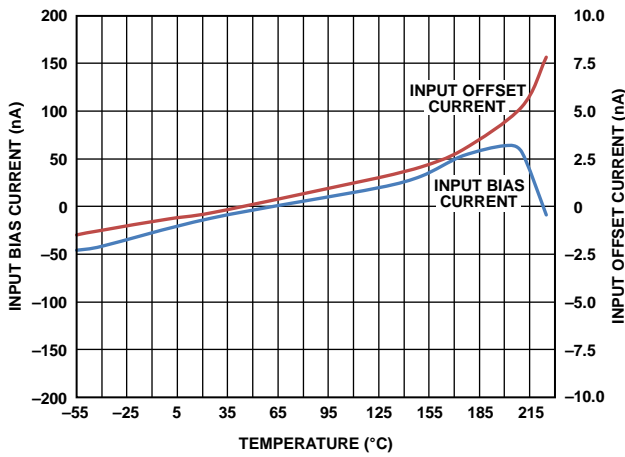

Figure 24. Input Bias Current and Input Offset Current vs. Temperature

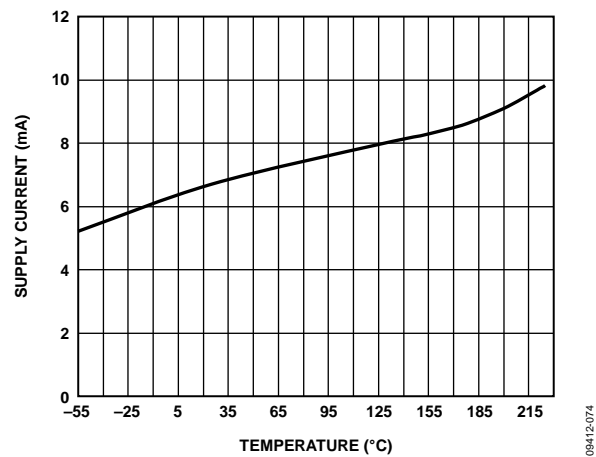

Figure 27. Supply Current vs. Temperature, $G = 1$

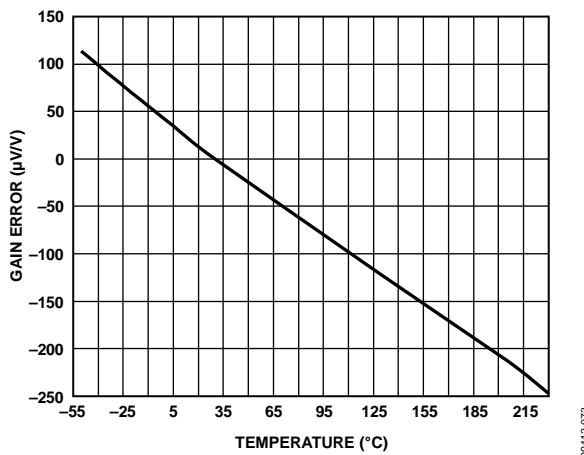

Figure 25. Gain Error vs. Temperature, $G = 1$, Normalized at 25°C

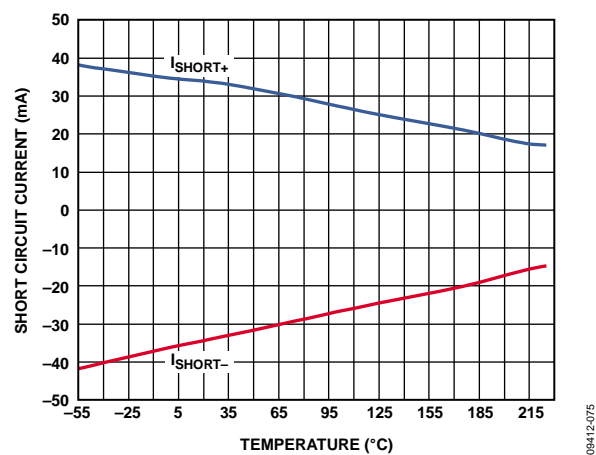

Figure 28. Short-Circuit Current vs. Temperature, $G = 1$

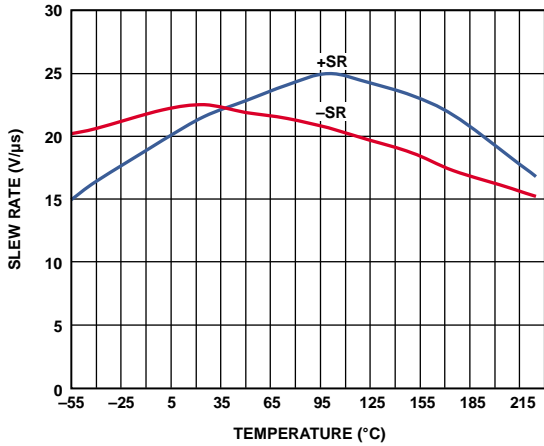

Figure 29. Slew Rate vs. Temperature, $V_S = \pm 15\text{ V}$, $G = 1$

09412-076

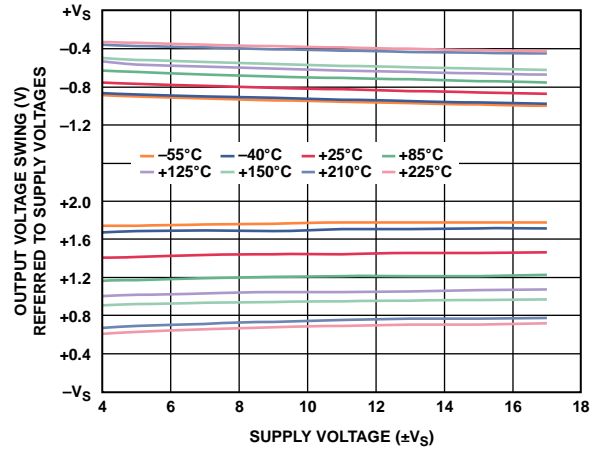

Figure 32. Output Voltage Swing vs. Supply Voltage, $R_L = 10\text{ k}\Omega$

09412-029

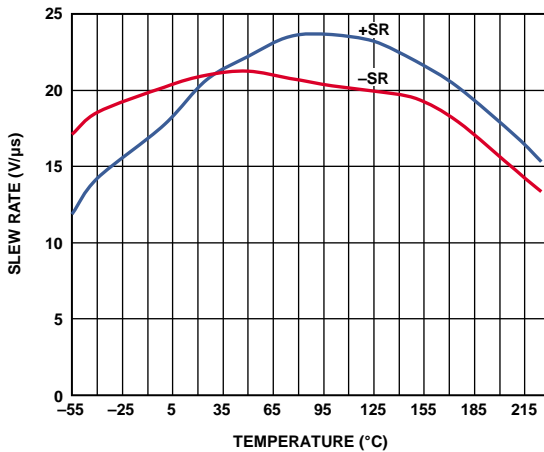

Figure 30. Slew Rate vs. Temperature, $V_S = \pm 5\text{ V}$, $G = 1$

09412-077

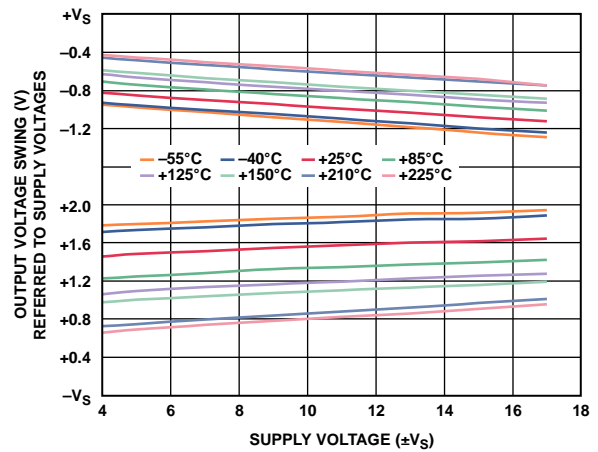

Figure 33. Output Voltage Swing vs. Supply Voltage, $R_L = 2\text{ k}\Omega$

09412-030

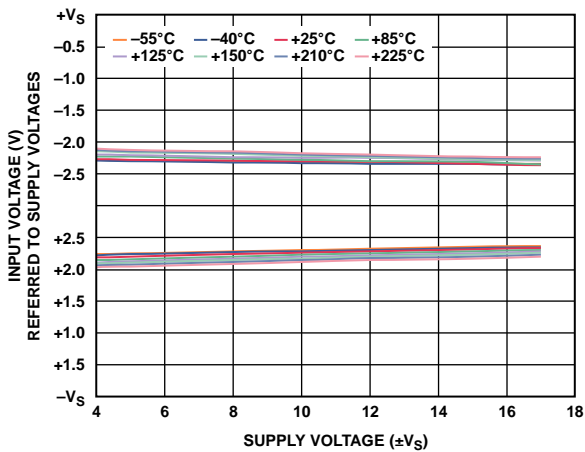

Figure 31. Input Voltage Limit vs. Supply Voltage

09412-028

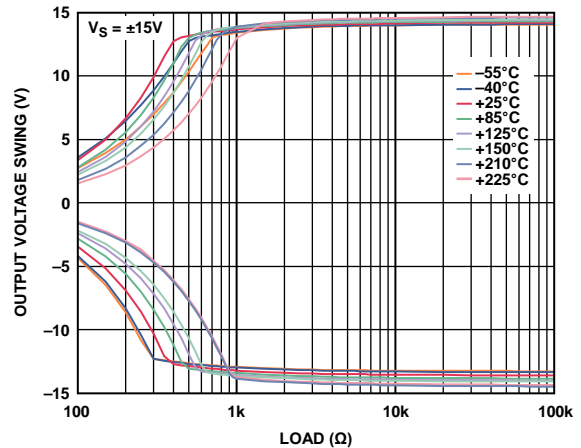

Figure 34. Output Voltage Swing vs. Load Resistance

09412-031

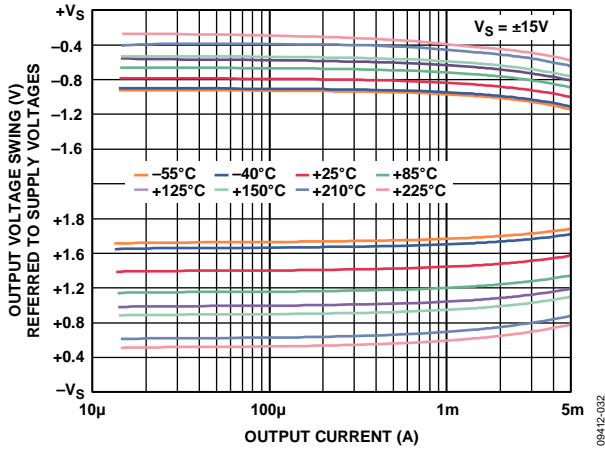

Figure 35. Output Voltage Swing vs. Output Current

08412-032

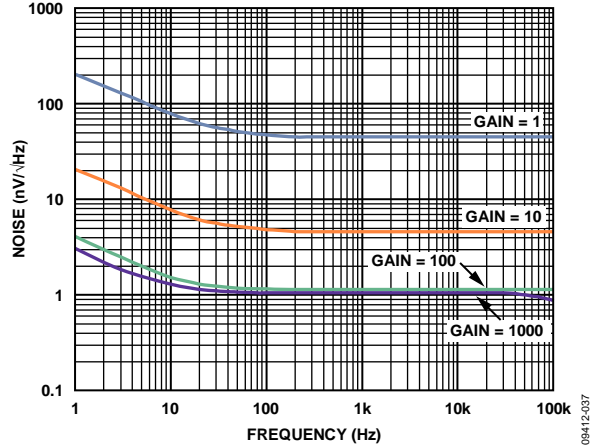

Figure 38. Voltage Noise Spectral Density vs. Frequency

08412-037

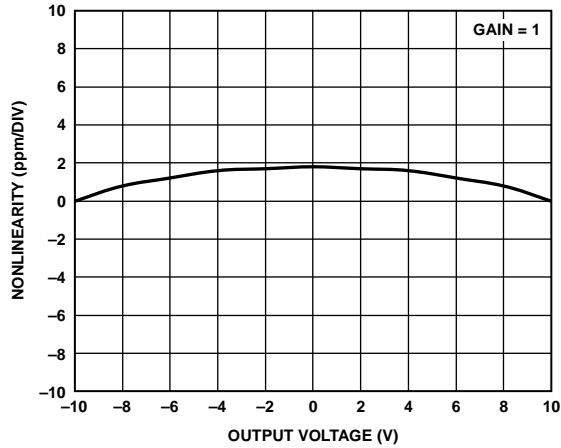

Figure 36. Gain Nonlinearity, $G = 1$, $R_L = 10\text{ k}\Omega$

08412-083

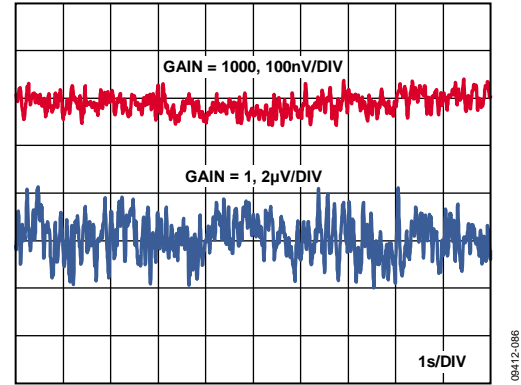

Figure 39. 0.1 Hz to 10 Hz RTI Voltage Noise, $G = 1$, $G = 1000$

08412-086

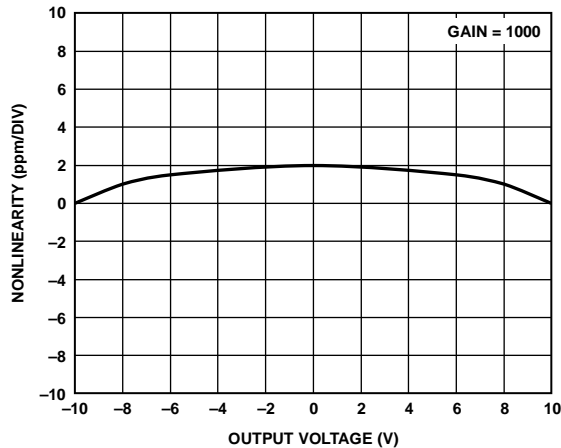

Figure 37. Gain Nonlinearity, $G = 1000$, $R_L = 10\text{ k}\Omega$

08412-084

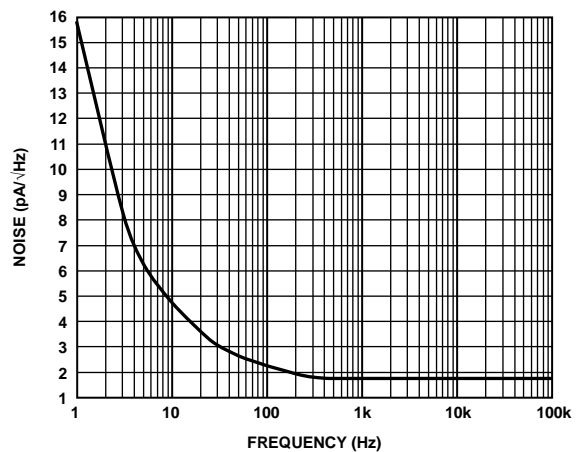

Figure 40. Current Noise Spectral Density vs. Frequency

08412-087

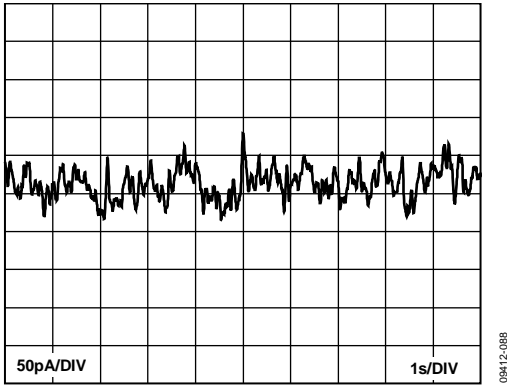

Figure 41. 1 Hz to 10 Hz Current Noise

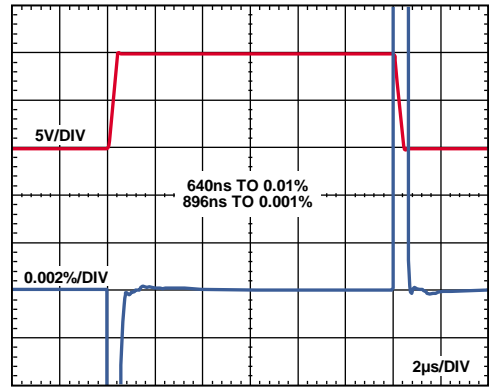

Figure 44. Large Signal Pulse Response and Settling Time ($G = 10$), 10 V Step, $V_S = \pm 15$ V

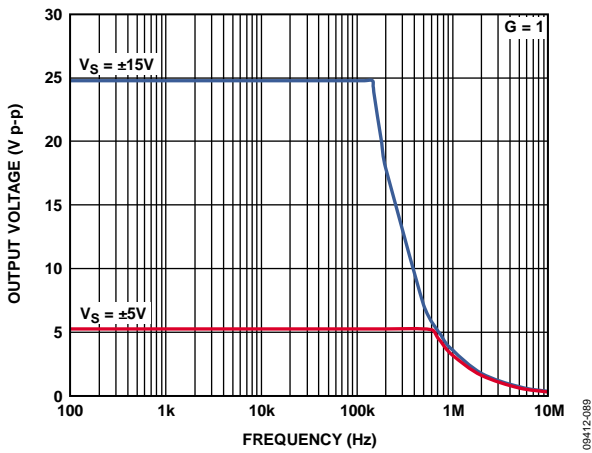

Figure 42. Large Signal Frequency Response

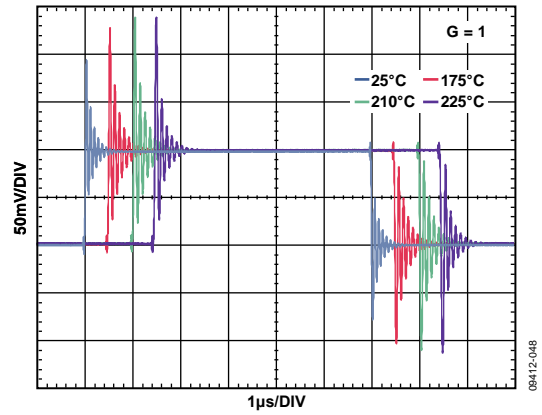

Figure 45. Small Signal Response, $G = 1$, $R_L = 10$ k Ω , $C_L = 100$ pF

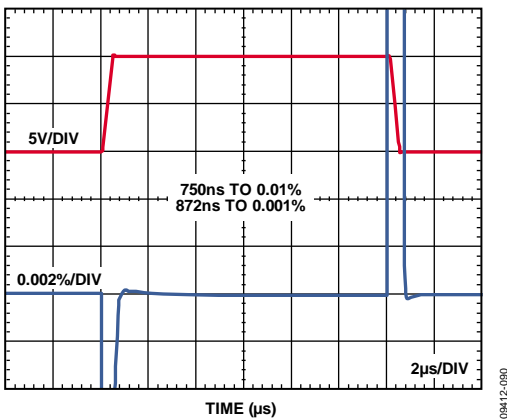

Figure 43. Large Signal Pulse Response and Settling Time ($G = 1$), 10 V Step, $V_S = \pm 15$ V

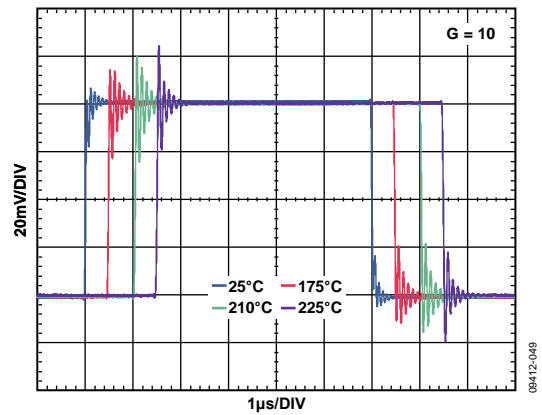

Figure 46. Small Signal Response, $G = 10$, $R_L = 10$ k Ω , $C_L = 100$ pF

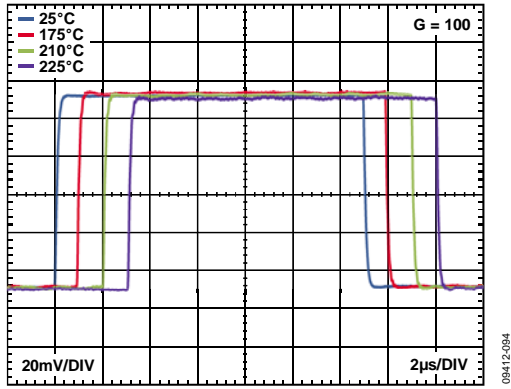

Figure 47. Small Signal Response, $G = 100$, $R_L = 10\text{ k}\Omega$, $C_L = 100\text{ pF}$

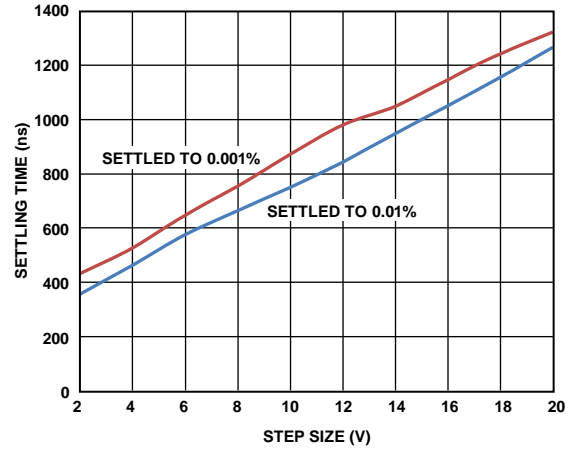

Figure 50. Settling Time vs. Step Size, $G = 1$

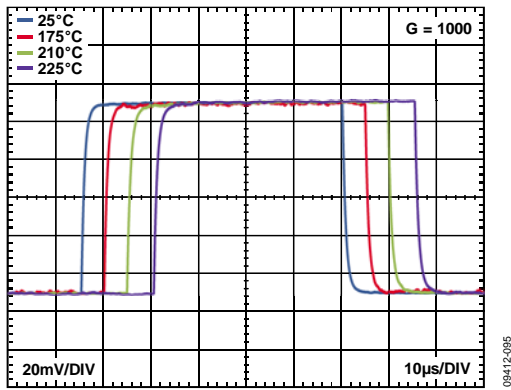

Figure 48. Small Signal Response, $G = 1000$, $R_L = 10\text{ k}\Omega$, $C_L = 100\text{ pF}$

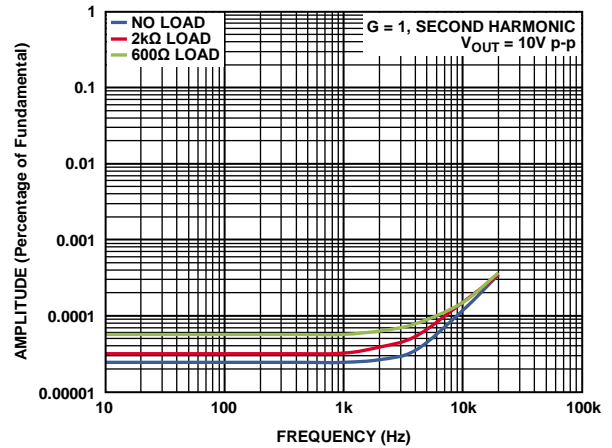

Figure 51. Second Harmonic Distortion vs. Frequency, $G = 1$

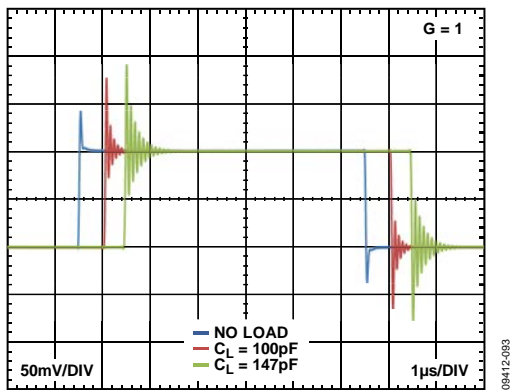

Figure 49. Small Signal Response with Various Capacitive Loads, $G = 1$, $R_L = \text{Infinity}$

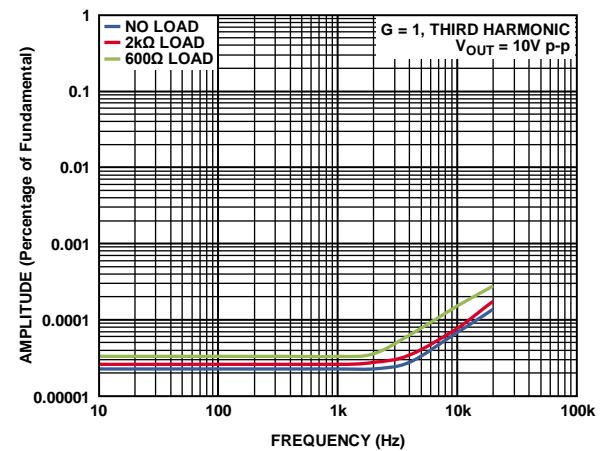

Figure 52. Third Harmonic Distortion vs. Frequency, $G = 1$

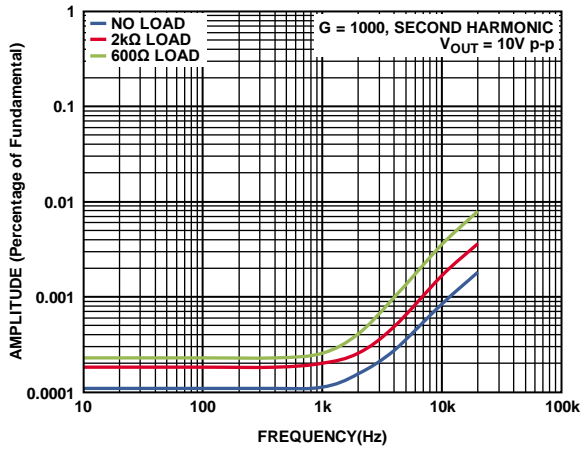

Figure 53. Second Harmonic Distortion vs. Frequency, G = 1000

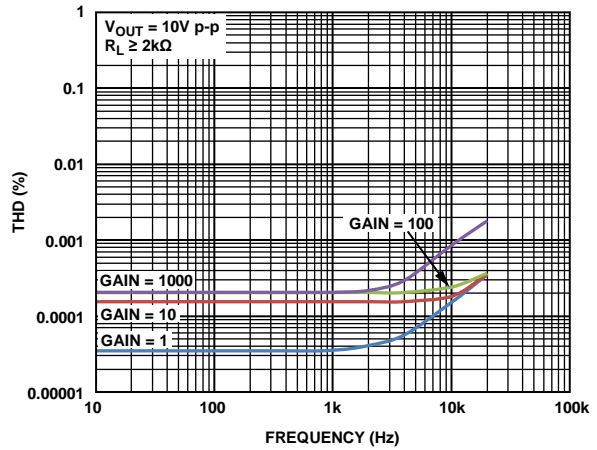

Figure 55. THD vs. Frequency

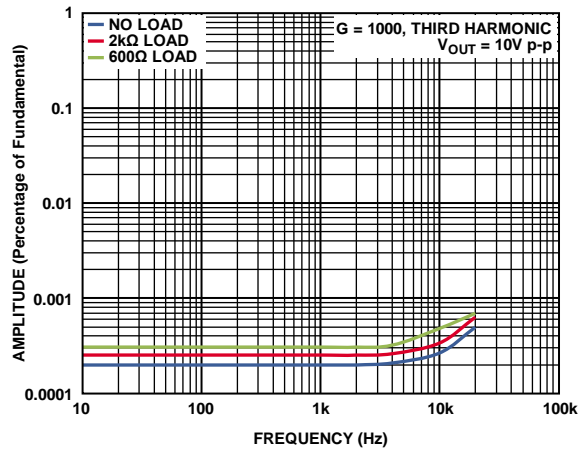

Figure 54. Third Harmonic Distortion vs. Frequency, G = 1000

09412-098

09412-100

09412-099

THEORY OF OPERATION

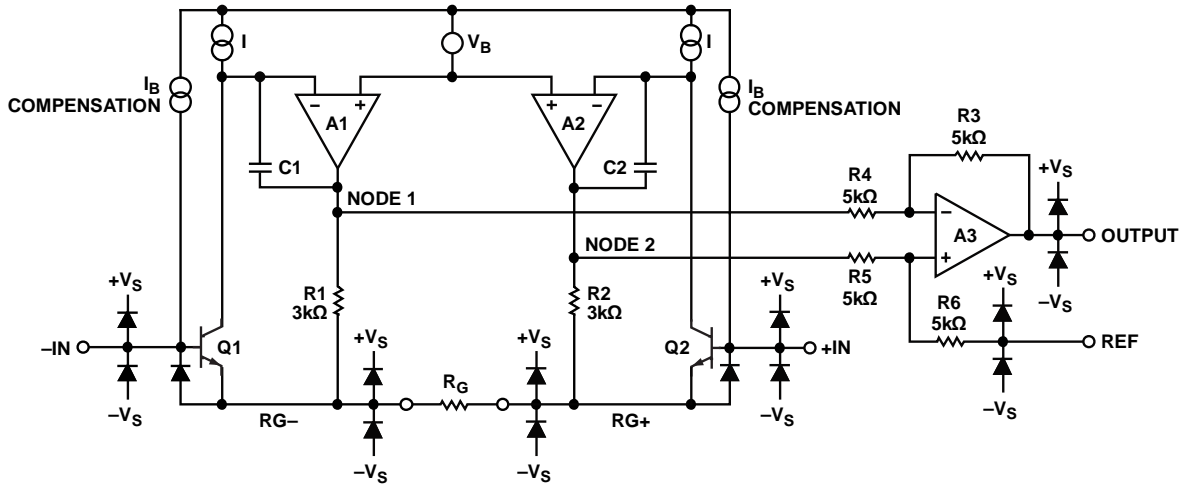

Figure 56. Simplified Schematic

08412-058

ARCHITECTURE

The AD8229 is based on the classic 3-op-amp topology. This topology has two stages: a preamplifier to provide differential amplification followed by a difference amplifier that removes the common-mode voltage and provides additional amplification.

Figure 56 shows a simplified schematic of the AD8229.

The first stage works as follows. To keep its two inputs matched, Amplifier A1 must keep the collector of Q1 at a constant voltage. It does this by forcing RG– to be a precise diode drop from –IN. Similarly, A2 forces RG+ to be a constant diode drop from +IN. Therefore, a replica of the differential input voltage is placed across the gain setting resistor, RG. The current that flows through this resistance must also flow through the R1 and R2 resistors, creating a gained differential signal between the A2 and A1 outputs.

The second stage is a G = 1 difference amplifier, composed of Amplifier A3 and the R3 through R6 resistors. This stage removes the common-mode signal from the amplified differential signal.

The transfer function of the AD8229 is

$$V_{OUT} = G \times (V_{IN+} - V_{IN-}) + V_{REF}$$

where:

$$G = 1 + \frac{6 \text{ k}\Omega}{R_G}$$

GAIN SELECTION

Placing a resistor across the RG terminals sets the gain of the AD8229, which can be calculated by referring to Table 5 or by using the following gain equation:

$$R_G = \frac{6 \text{ k}\Omega}{G - 1}$$

Table 5. Gains Achieved Using 1% Resistors

1% Standard Table Value of RG (Ω)	Calculated Gain
6.04 k	1.993
1.5 k	5.000
665	10.02
316	19.99
121	50.59
60.4	100.34
30.1	200.34
12.1	496.9
6.04	994.4
3.01	1994.355

The AD8229 defaults to G = 1 when no gain resistor is used. The tolerance and gain drift of the RG resistor should be added to the AD8229's specifications to determine the total gain accuracy of the system. When the gain resistor is not used, gain error and gain drift are minimal.

RG Power Dissipation

The AD8229 duplicates the differential voltage across its inputs onto the RG resistor. The RG resistor size should be chosen to handle the expected power dissipation.

REFERENCE TERMINAL

The output voltage of the AD8229 is developed with respect to the potential on the reference terminal. This is useful when the output signal must be offset to a precise midsupply level. For example, a voltage source can be tied to the REF pin to level-shift the output so that the AD8229 can drive a single-supply ADC. The REF pin is protected with ESD diodes and should not exceed either +Vs or –Vs by more than 0.3 V.

For best performance, source impedance to the REF terminal should be kept well below $1\ \Omega$. As shown in Figure 56, the reference terminal, REF, is at one end of a $5\ \text{k}\Omega$ resistor. Additional impedance at the REF terminal adds to this $5\ \text{k}\Omega$ resistor and results in amplification of the signal connected to the positive input. The amplification from the additional R_{REF} can be calculated as follows:

$$2(5\ \text{k}\Omega + R_{REF}) / (10\ \text{k}\Omega + R_{REF})$$

Only the positive signal path is amplified; the negative path is unaffected. This uneven amplification degrades CMRR.

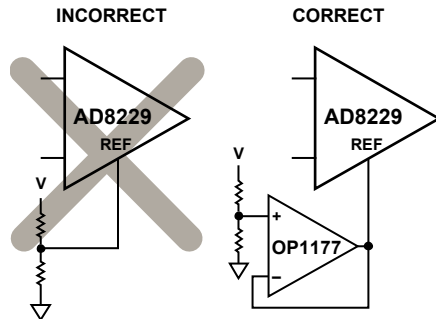

Figure 57. Driving the Reference Pin

INPUT VOLTAGE RANGE

Figure 11 through Figure 16 show the allowable common-mode input voltage ranges for various output voltages and supply voltages. The 3-op-amp architecture of the AD8229 applies gain in the first stage before removing common-mode voltage with the difference amplifier stage. Internal nodes between the first and second stages (Node 1 and Node 2 in Figure 56) experience a combination of a gained signal, a common-mode signal, and a diode drop. This combined signal can be limited by the voltage supplies even when the individual input and output signals are not limited.

LAYOUT

To ensure optimum performance of the AD8229 at the PCB level, care must be taken in the design of the board layout. The pins of the AD8229 are arranged in a logical manner to aid in this task.

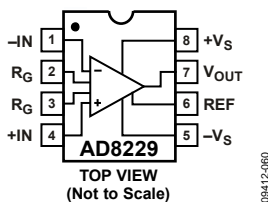

Figure 58. Pinout Diagram

Common-Mode Rejection Ratio over Frequency

Poor layout can cause some of the common-mode signals to be converted to differential signals before reaching the in-amp. Such conversions occur when one input path has a frequency response that is different from the other. To keep CMRR over frequency high, the input source impedance and capacitance of each path should be closely matched. Additional source resistance in the input path (for example, for input protection) should be placed close to the in-amp inputs, which minimizes their interaction with parasitic capacitance from the PCB traces.

Parasitic capacitance at the gain setting pins can also affect CMRR over frequency. If the board design has a component at the gain setting pins (for example, a switch or jumper), the component should be chosen so that the parasitic capacitance is as small as possible.

Power Supplies

A stable dc voltage should be used to power the instrumentation amplifier. Noise on the supply pins can adversely affect performance. See the PSRR performance curves in Figure 18 and Figure 19 for more information.

A $0.1\ \mu\text{F}$ capacitor should be placed as close as possible to each supply pin. As shown in Figure 59, a $10\ \mu\text{F}$ tantalum capacitor can be used farther away from the part. In most cases, it can be shared by other precision integrated circuits.

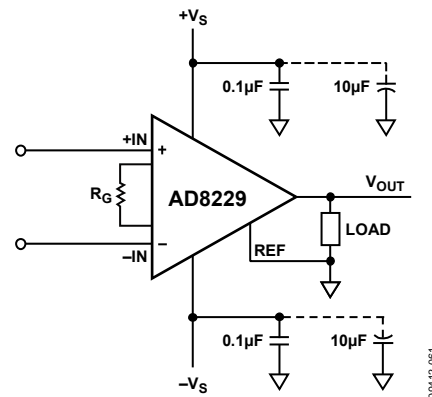

Figure 59. Supply Decoupling, REF, and Output Referred to Local Ground

Reference Pin

The output voltage of the AD8229 is developed with respect to the potential on the reference terminal. Care should be taken to tie REF to the appropriate local ground.

INPUT BIAS CURRENT RETURN PATH

The input bias current of the AD8229 must have a return path to ground. When using a floating source without a current return path, such as a thermocouple, a current return path should be created, as shown in Figure 60.

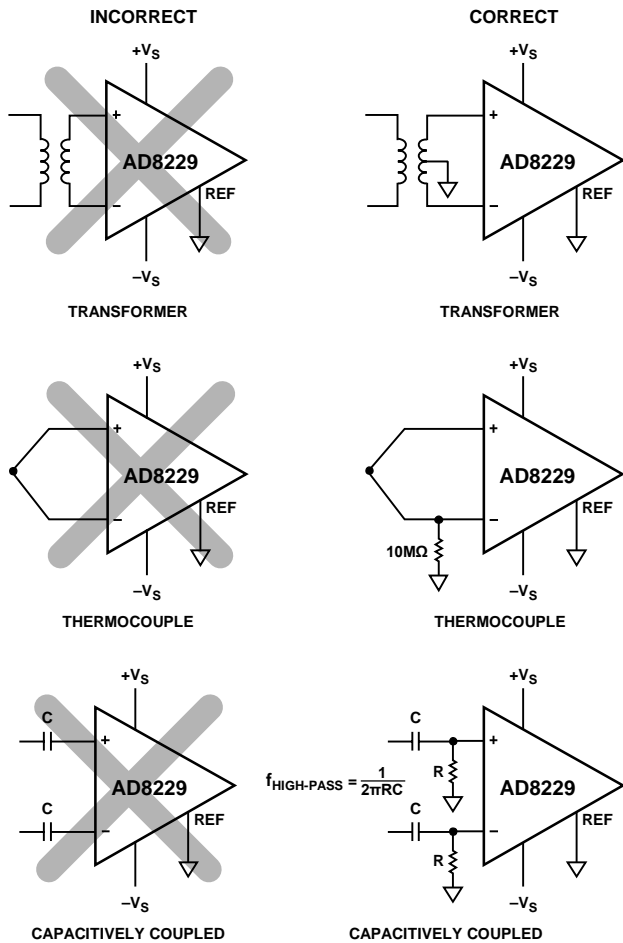

Figure 60. Creating an Input Bias Current Return Path

INPUT PROTECTION

The inputs to the AD8229 should be kept within the ratings stated in the Absolute Maximum Ratings section. If this cannot be done, protection circuitry can be added in front of the AD8229 to limit the current into the inputs to a maximum current, I_{MAX} .

Input Voltages Beyond the Rails

If voltages beyond the rails are expected, use an external resistor in series with each input to limit current during overload conditions. The limiting resistor at the input can be computed from

$$R_{PROTECT} \geq \frac{|V_{IN} - V_{SUPPLY}|}{I_{MAX}}$$

Noise-sensitive applications may require a lower protection resistance. Low leakage diode clamps, such as the BAV199, can be used at the inputs to shunt current away from the AD8229 inputs and therefore allow smaller protection resistor values. To ensure current flows primarily through the external protection diodes,

place a small value resistor, such as a 33 Ω, between the diodes and the AD8229.

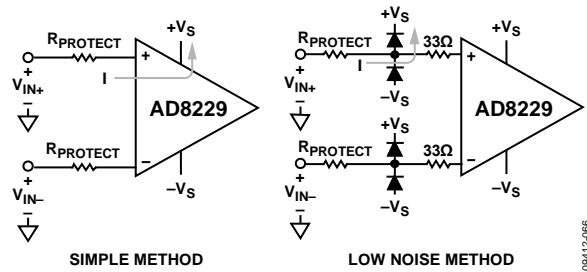

Figure 61. Protection for Voltages Beyond the Rails

Large Differential Input Voltage at High Gain

If large differential voltages at high gain are expected, use an external resistor in series with each input to limit current during overload conditions. The limiting resistor at each input can be computed from

$$R_{PROTECT} \geq \frac{1}{2} \left(\frac{|V_{DIFF}| - 1V}{I_{MAX}} - R_G \right)$$

Noise-sensitive applications may require a lower protection resistance. Low leakage diode clamps, such as the BAV199, can be used across the inputs to shunt current away from the AD8229 inputs and therefore allow smaller protection resistor values.

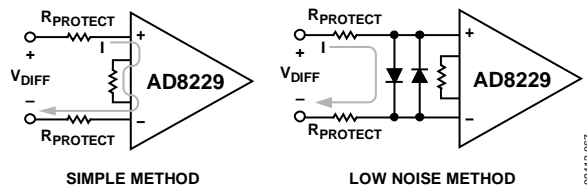

Figure 62. Protection for Large Differential Voltages

I_{MAX}

The maximum current into the AD8229 inputs, I_{MAX} , depends on both time and temperature. At room temperature, the part can withstand a current of 10 mA for at least a day. This time is cumulative over the life of the part. At 210°C, limit current to 2 mA for the same period. The part can withstand 5 mA at 210°C for an hour, cumulative over the life of the part.

RADIO FREQUENCY INTERFERENCE (RFI)

RF rectification is often a problem when amplifiers are used in applications that have strong RF signals. The disturbance can appear as a small dc offset voltage. High frequency signals can be filtered with a low-pass RC network placed at the input of the instrumentation amplifier, as shown in Figure 63. The filter limits the input signal bandwidth, according to the following relationship:

$$FilterFrequency_{DIFF} = \frac{1}{2\pi R(2C_D + C_C)}$$

$$FilterFrequency_{CM} = \frac{1}{2\pi RC_C}$$

where $C_D \geq 10 C_C$.

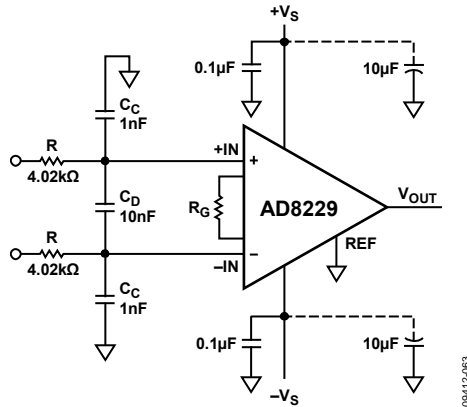

Figure 63. RFI Suppression

C_D affects the difference signal, and C_C affects the common-mode signal. Values of R and C_C should be chosen to minimize RFI. A mismatch between $R \times C_C$ at the positive input and $R \times C_C$ at the negative input degrades the CMRR of the AD8229. By using a value of C_D one magnitude larger than C_C , the effect of the mismatch is reduced, and performance is improved.

Resistors add noise; therefore, the resistor and capacitor values chosen depend on the desired tradeoff between noise, input impedance at high frequencies, and RFI immunity. The resistors used for the RFI filter can be the same as those used for input protection.

CALCULATING THE NOISE OF THE INPUT STAGE

The total noise of the amplifier front end depends on much more than the $1 \text{ nV}/\sqrt{\text{Hz}}$ headline specification of this data sheet. There are three main contributors: the source resistance, the voltage noise of the instrumentation amplifier, and the current noise of the instrumentation amplifier.

In the following calculations, noise is referred to the input (RTI). In other words, everything is calculated as if it appeared at the amplifier input. To calculate the noise referred to the amplifier output (RTO), simply multiple the RTI noise by the gain of the instrumentation amplifier.

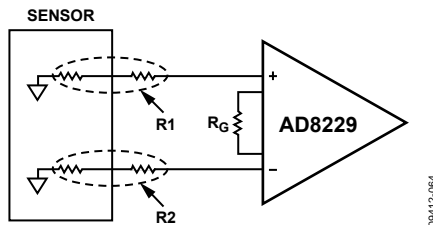

Figure 64. AD8229 with Source Resistance from Sensor and Protection Resistors

Source Resistance Noise

Any sensor connected to the AD8229 has some output resistance. There may also be resistance placed in series with inputs for protection from either overvoltage or radio frequency interference. This combined resistance is labeled R_1 and R_2 in Figure 64. Any resistor, no matter how well made, has a minimum level of noise. This noise is proportional to the square root of the resistor value. At room temperature, the value is approximately equal to $4 \text{ nV}/\sqrt{\text{Hz}} \times \sqrt{(\text{resistor value in k}\Omega)}$.

For example, assuming that the combined sensor and protection resistance on the positive input is $4 \text{ k}\Omega$, and on the negative input is $1 \text{ k}\Omega$, the total noise from the input resistance is

$$\sqrt{(4 \times \sqrt{4})^2 + (4 \times \sqrt{1})^2} = \sqrt{64 + 16} = 8.9 \text{ nV}/\sqrt{\text{Hz}}$$

Voltage Noise of the Instrumentation Amplifier

The voltage noise of the instrumentation amplifier is calculated using three parameters: the part input noise, output noise, and the R_G resistor noise. It is calculated as follows:

Total Voltage Noise =

$$\sqrt{(\text{Output Noise}/G)^2 + (\text{Input Noise})^2 + (\text{Noise of } R_G \text{ Resistor})^2}$$

For example, for a gain of 100, the gain resistor is 60.4Ω . Therefore, the voltage noise of the in-amp is

$$\sqrt{(45/100)^2 + 1^2 + (4 \times \sqrt{0.0604})^2} = 1.5 \text{ nV}/\sqrt{\text{Hz}}$$

Current Noise of the Instrumentation Amplifier

Current noise is calculated by multiplying the source resistance by the current noise.

For example, if the R_1 source resistance in Figure 64 is $4 \text{ k}\Omega$, and the R_2 source resistance is $1 \text{ k}\Omega$, the total effect from the current noise is calculated as follows:

$$\sqrt{((4 \times 1.5)^2 + (1 \times 1.5)^2)} = 6.2 \text{ nV}/\sqrt{\text{Hz}}$$

Total Noise Density Calculation

To determine the total noise of the in-amp, referred to input, combine the source resistance noise, voltage noise, and current noise contribution by the sum of squares method.

For example, if the R_1 source resistance in Figure 64 is $4 \text{ k}\Omega$, the R_2 source resistance is $1 \text{ k}\Omega$, and the gain of the in-amps is 100, the total noise, referred to input, is

$$\sqrt{8.9^2 + 1.5^2 + 6.2^2} = 11.0 \text{ nV}/\sqrt{\text{Hz}}$$

OUTLINE DIMENSIONS

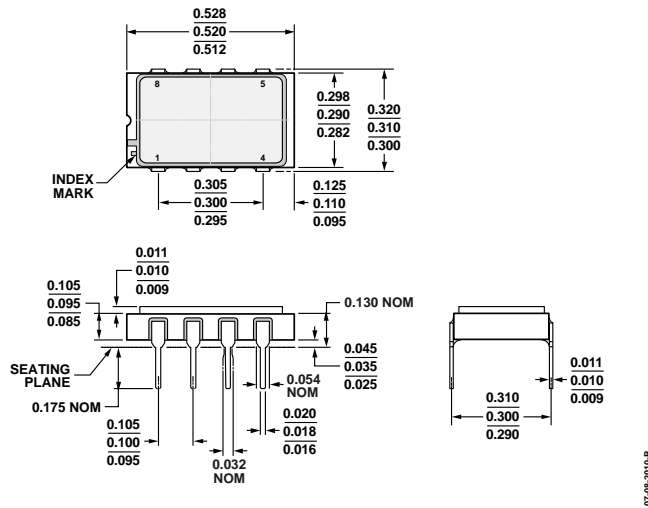
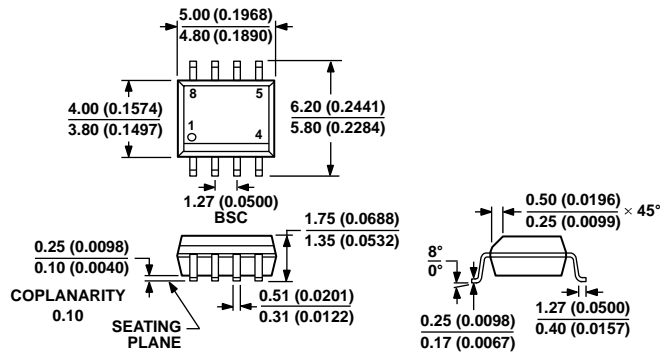

Figure 65. 8-Lead Side-Brazed Ceramic Dual In-Line Package [SBDIP] (D-8-1)
Dimensions shown in inches



COMPLIANT TO JEDEC STANDARDS MS-012-AA
CONTROLLING DIMENSIONS ARE IN MILLIMETERS; INCH DIMENSIONS (IN PARENTHESES) ARE ROUNDED-OFF MILLIMETER EQUIVALENTS FOR REFERENCE ONLY AND ARE NOT APPROPRIATE FOR USE IN DESIGN.

Figure 66. 8-Lead Standard Small Outline Package [SOIC_N] Narrow Body (R-8)
Dimensions shown in millimeters and (inches)

ORDERING GUIDE

Model ¹	Temperature Range	Package Description	Package Option
AD8229HDZ	-40°C to +210°C	8-Lead Side-Brazed Ceramic Dual In-Line Package [SBDIP]	D-8-1
AD8229HRZ	-40°C to +175°C	8-Lead Standard Small Outline Package [SOIC_N]	R-8
AD8229HRZ-R7	-40°C to +175°C	8-Lead Standard Small Outline Package [SOIC_N]	R-8

¹ Z = RoHS Compliant Part.

NOTES

NOTES

NOTES



Компания «ЭлектроПласт» предлагает заключение долгосрочных отношений при поставках импортных электронных компонентов на взаимовыгодных условиях!

Наши преимущества:

- Оперативные поставки широкого спектра электронных компонентов отечественного и импортного производства напрямую от производителей и с крупнейших мировых складов;
- Поставка более 17-ти миллионов наименований электронных компонентов;
- Поставка сложных, дефицитных, либо снятых с производства позиций;
- Оперативные сроки поставки под заказ (от 5 рабочих дней);
- Экспресс доставка в любую точку России;
- Техническая поддержка проекта, помощь в подборе аналогов, поставка прототипов;
- Система менеджмента качества сертифицирована по Международному стандарту ISO 9001;
- Лицензия ФСБ на осуществление работ с использованием сведений, составляющих государственную тайну;
- Поставка специализированных компонентов (Xilinx, Altera, Analog Devices, Intersil, Interpoint, Microsemi, Aeroflex, Peregrine, Syfer, Eurofarad, Texas Instrument, Miteq, Cobham, E2V, MA-COM, Hittite, Mini-Circuits, General Dynamics и др.);

Помимо этого, одним из направлений компании «ЭлектроПласт» является направление «Источники питания». Мы предлагаем Вам помощь Конструкторского отдела:

- Подбор оптимального решения, техническое обоснование при выборе компонента;
- Подбор аналогов;
- Консультации по применению компонента;
- Поставка образцов и прототипов;
- Техническая поддержка проекта;
- Защита от снятия компонента с производства.



Как с нами связаться

Телефон: 8 (812) 309 58 32 (многоканальный)

Факс: 8 (812) 320-02-42

Электронная почта: org@eplast1.ru

Адрес: 198099, г. Санкт-Петербург, ул. Калинина, дом 2, корпус 4, литера А.