

Thin-Film Directional Couplers

DB0805 3dB 90° Couplers



GENERAL DESCRIPTION ITF TECHNOLOGY

The ITF SMD 3dB 90° Coupler is based on thin-film multilayer technology. The technology provides a miniature part with excellent high frequency performance and rugged construction for reliable automatic assembly.

The ITF 3dB 90° Coupler is offered in a variety of frequency bands compatible with various types of high frequency wireless systems.

Recommended Pad Layout Dimensions mm (inches)

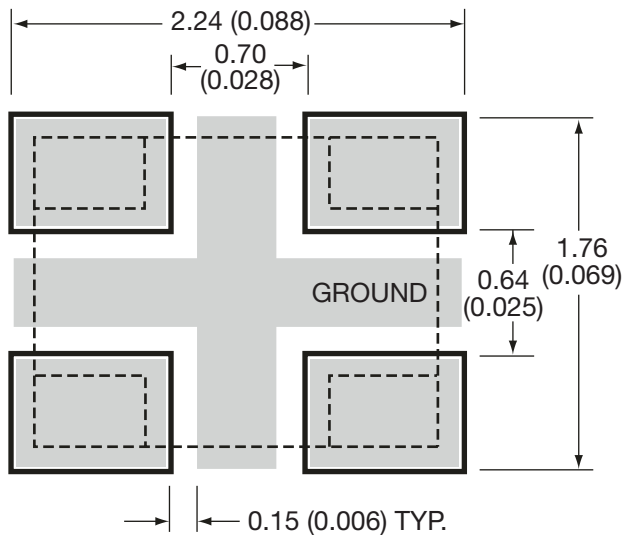

APPLICATIONS

- Balanced Amplifiers and Signal Distribution in Mobile Communications

FEATURES

- Miniature 0805 size
- Low I. Loss
- High Isolation
- Power Handling: 10W RF CW
- Surface Mountable
- Supplied on Tape and Reel
- Operating Temperature -40°C to +85°C

DIMENSIONS:

millimeters (inches)

L	2.03±0.10 (0.080±0.004)
W	1.55±0.10 (0.061±0.004)
T	0.98±0.15 (0.037±0.006)
A	0.56±0.25 (0.022±0.010)
B	0.35±0.15 (0.014±0.006)

Bottom View

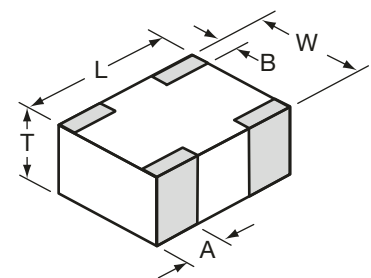

TERMINALS (Top View) Orientation in Tape

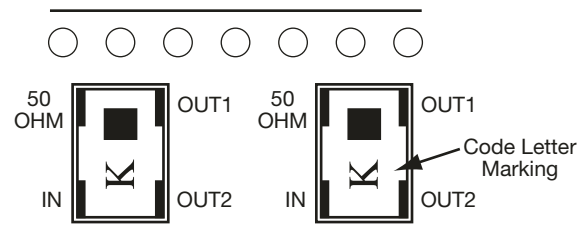

ELECTRICAL PARAMETERS*

Part Number**	Frequency F ₀ [MHz]	I. Loss @ F ₀ [dB]	Phase Balance [deg] max.	Code Letter Marking
DB0805A0880AWTR	880±30	0.35	3	Y
DB0805A0915AWTR	915±30	0.35	3	V
DB0805A0967AWTR	967±30	0.35	3	V
DB0805A1350AWTR	1350±50	0.35	3	C
DB0805A1650AWTR	1650±50	0.35	3	F
DB0805A1800AWTR	1800±50	0.30	3	F
DB0805A1850AWTR	1850±50	0.30	3	K
DB0805A1900AWTR	1900±50	0.30	3	K
DB0805A1950AWTR	1950±50	0.25	3	K
DB0805A2140AWTR	2140±50	0.25	3	L
DB0805A2325AWTR	2325±50	0.25	3	T

*With Recommended Pad Layout

NOTE: Additional Frequencies Available Upon Request

****LEAD FREE TERMINATION
PART NUMBERS:
DB0805AxxxxASTR**



Thin-Film Directional Couplers

DB0805 3dB 90° Couplers



880 ± 30MHz DB0805A0880AWTR

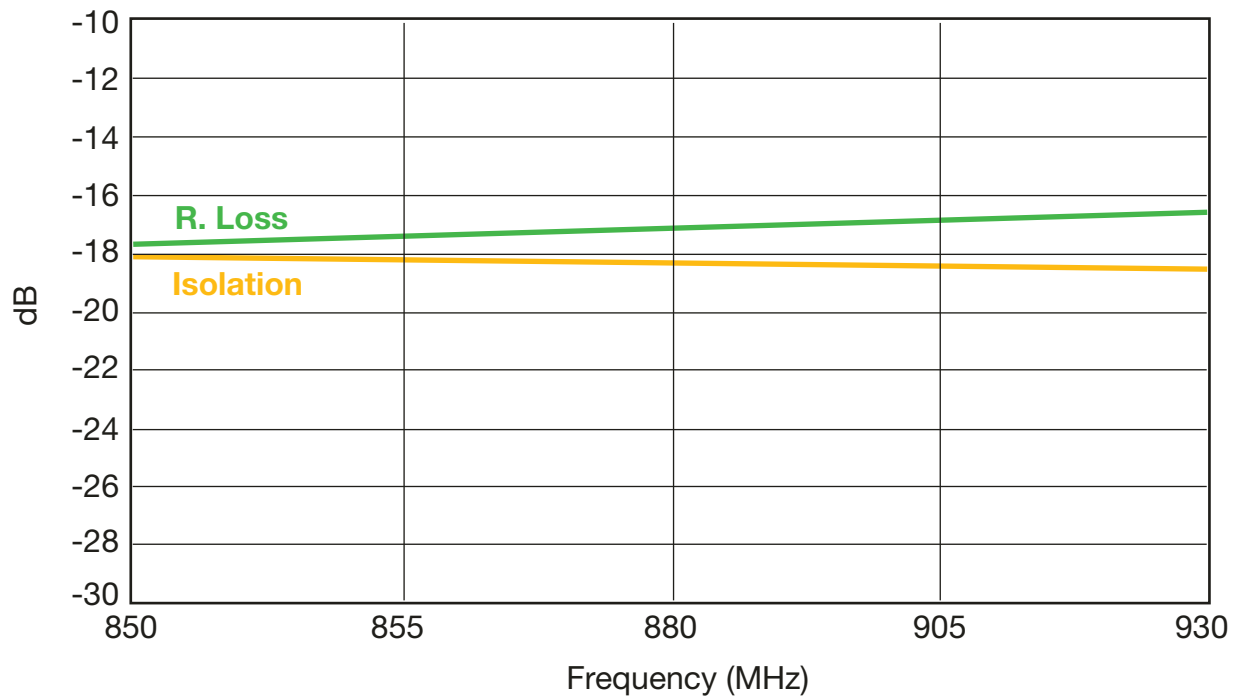
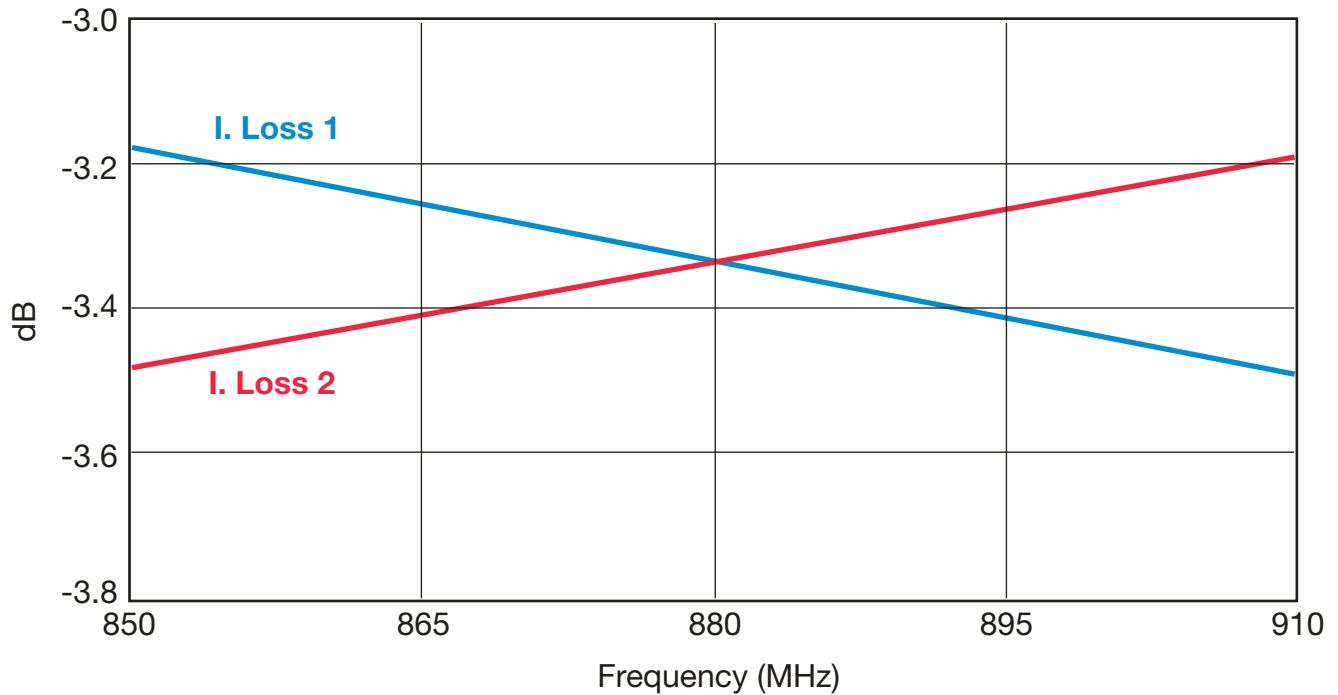

3

Thin-Film Directional Couplers

DB0805 3dB 90° Couplers



915 ± 30MHz DB0805A0915AWTR

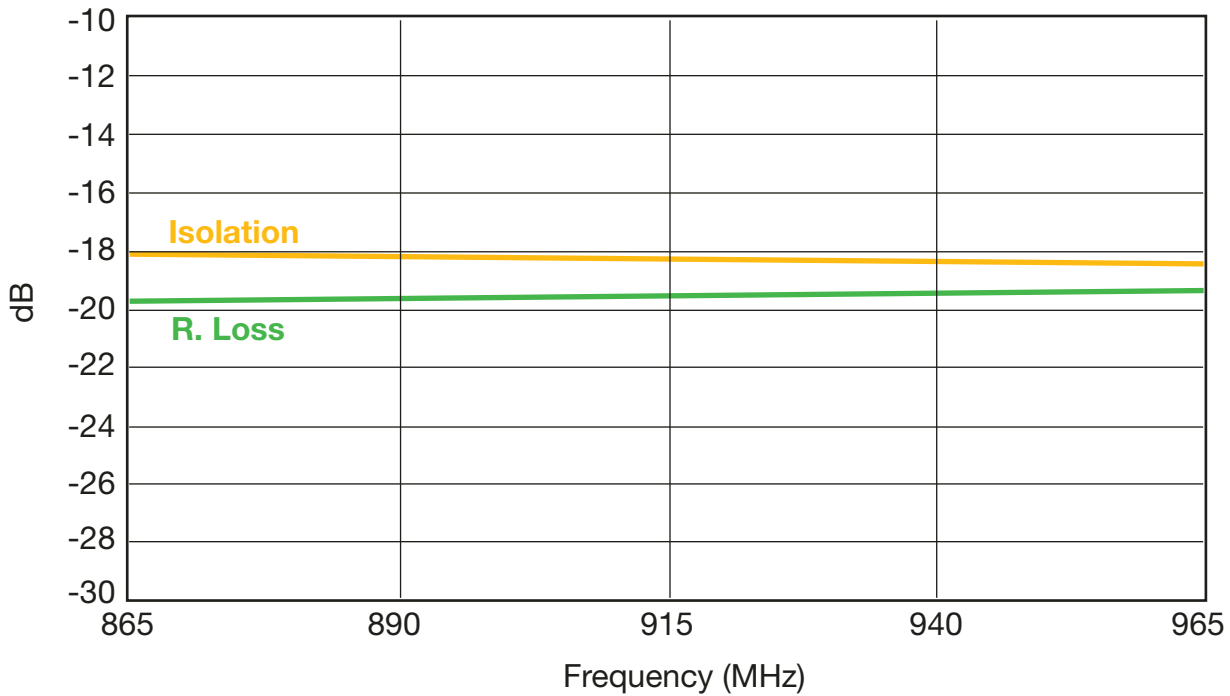
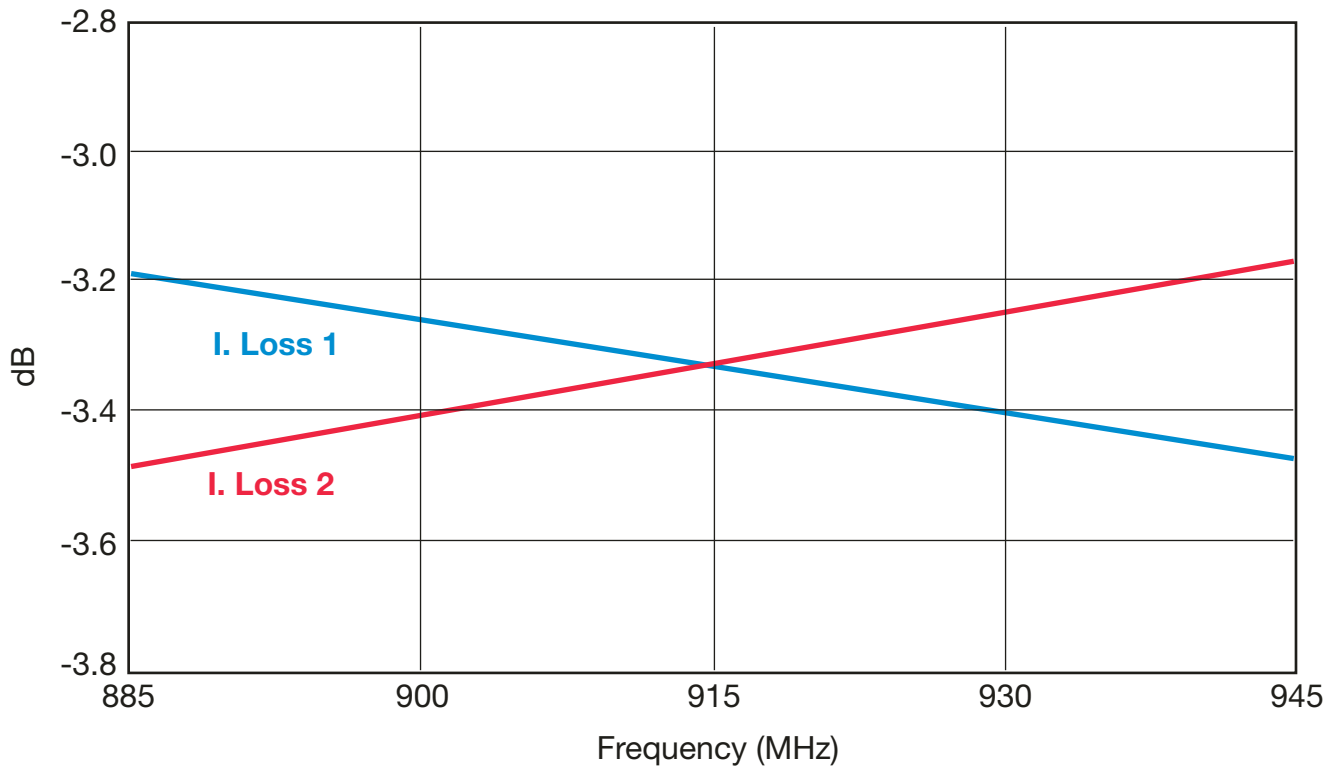

3

Thin-Film Directional Couplers

DB0805 3dB 90° Couplers



967± 30MHz DB0805A0967AWTR

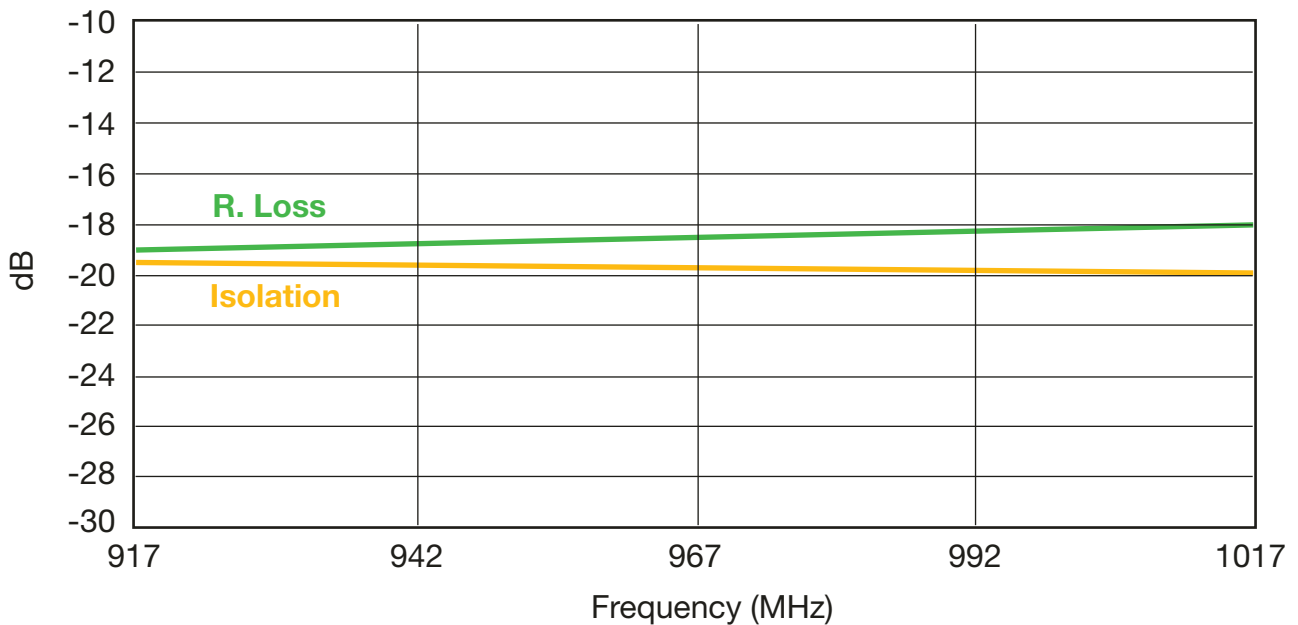
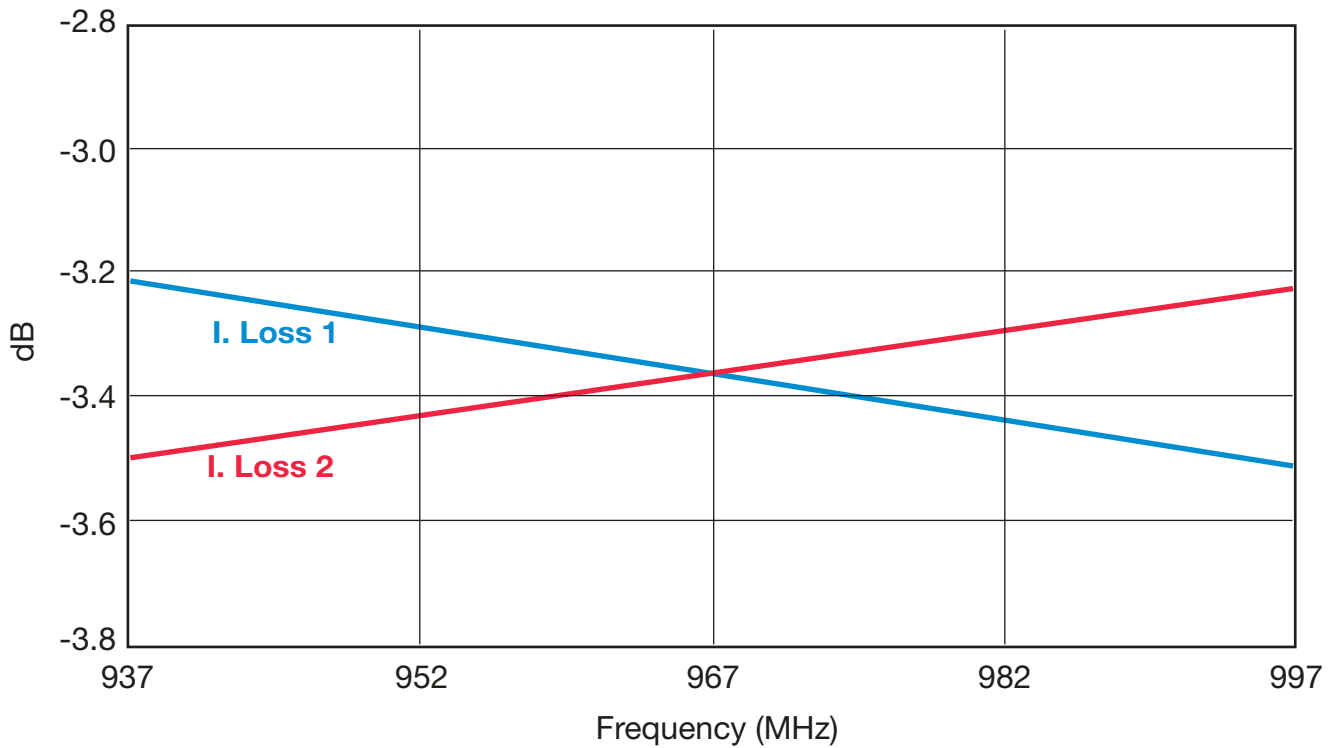

Thin-Film Directional Couplers

DB0805 3dB 90° Couplers



1350 ± 50MHz DB0805A1350AWTR

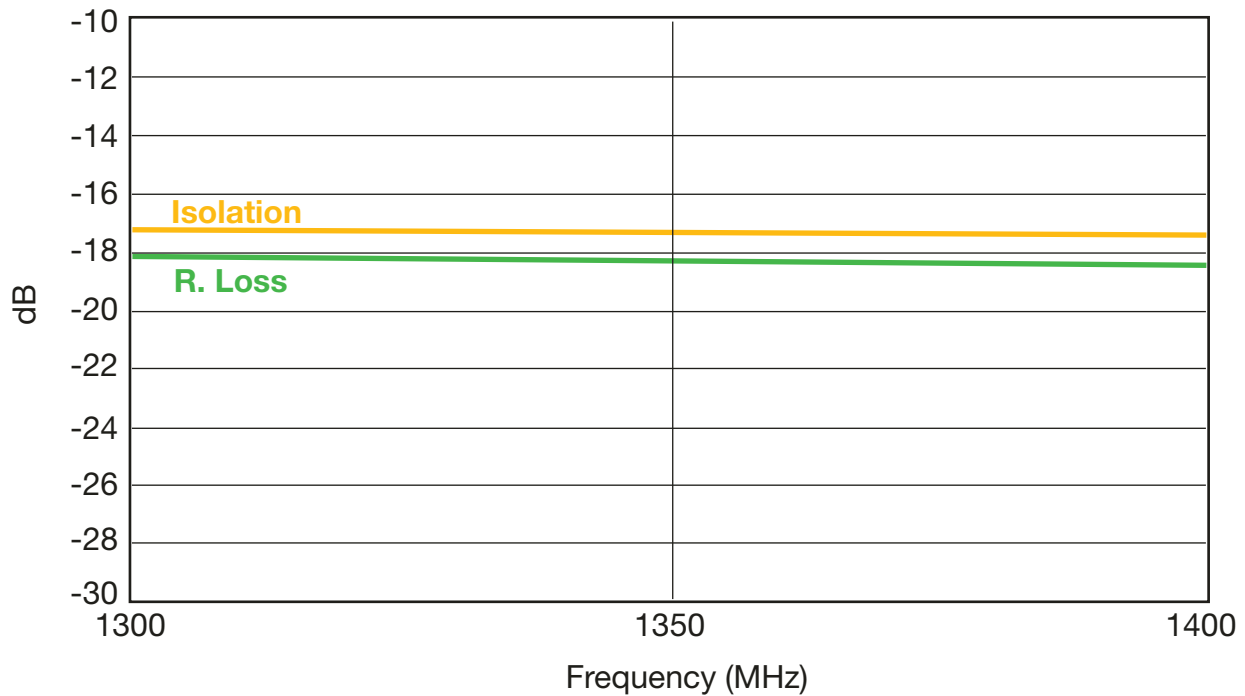
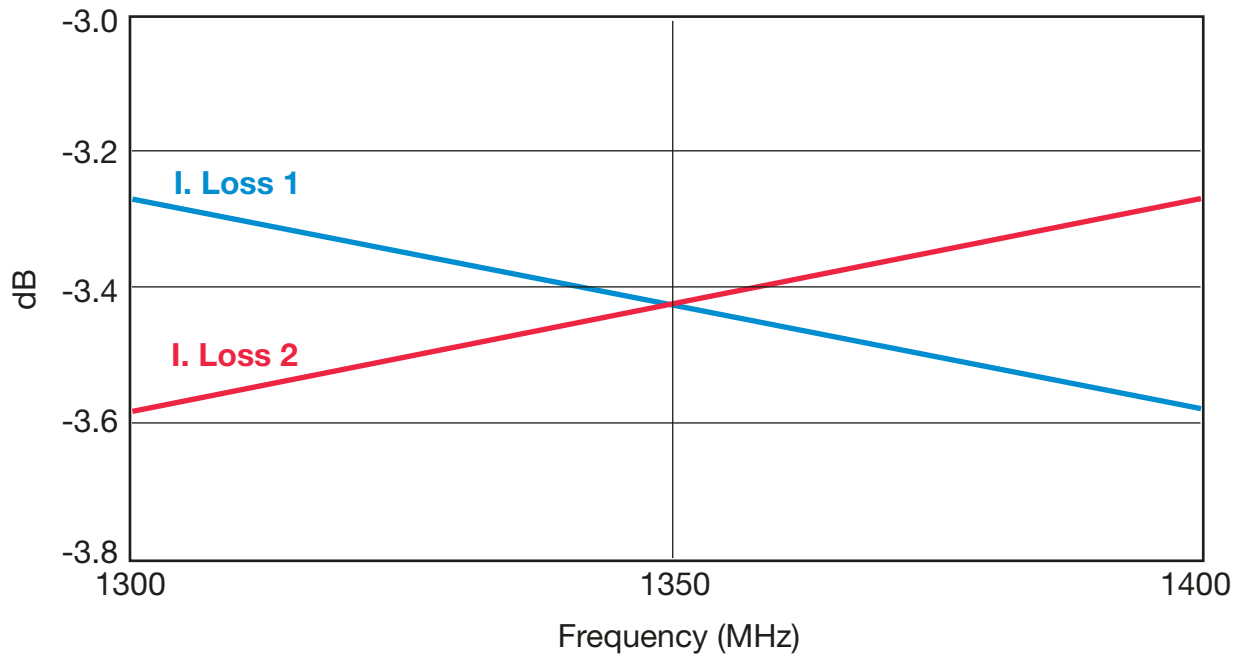

3

Thin-Film Directional Couplers

DB0805 3dB 90° Couplers



1650 ± 50MHz DB0805A1650AWTR

3

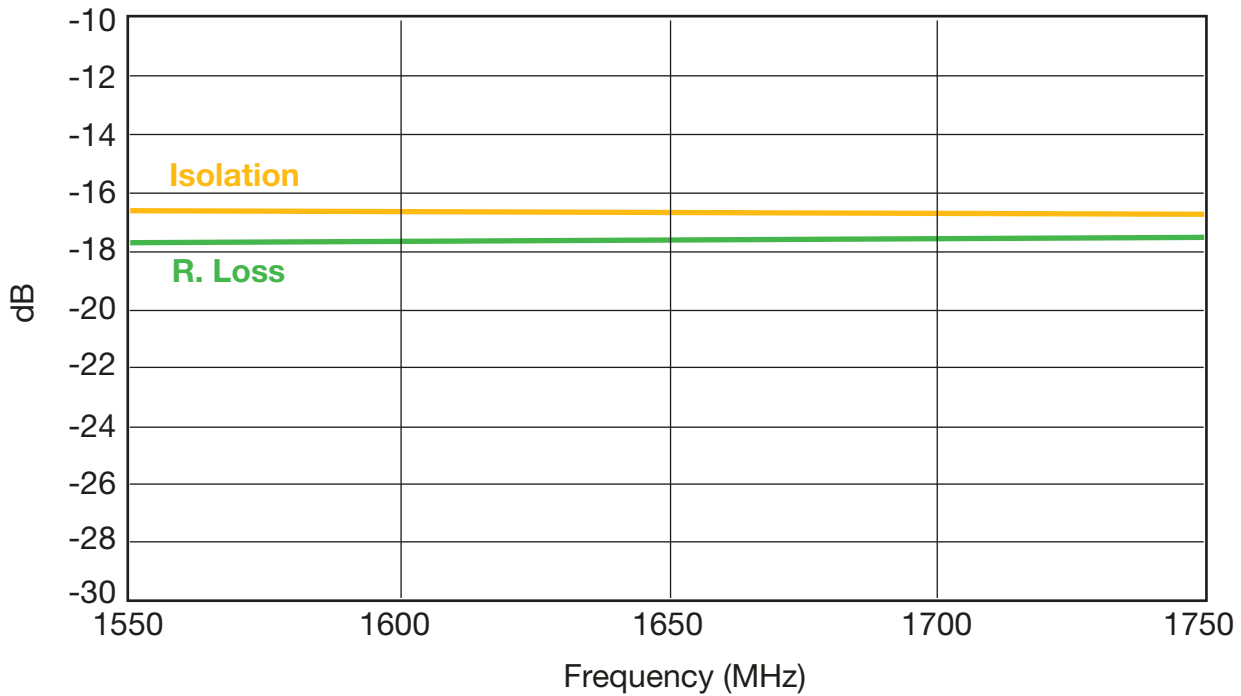
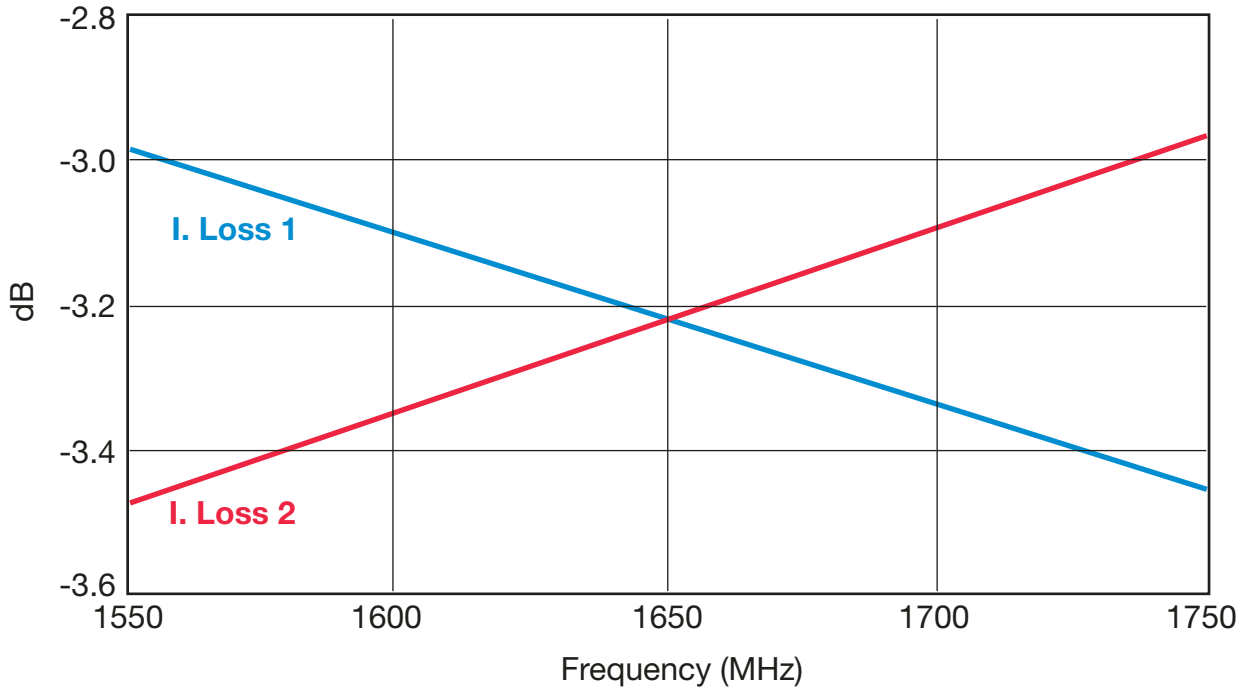

Thin-Film Directional Couplers

DB0805 3dB 90° Couplers



1800 ± 50MHz DB0805A1800AWTR

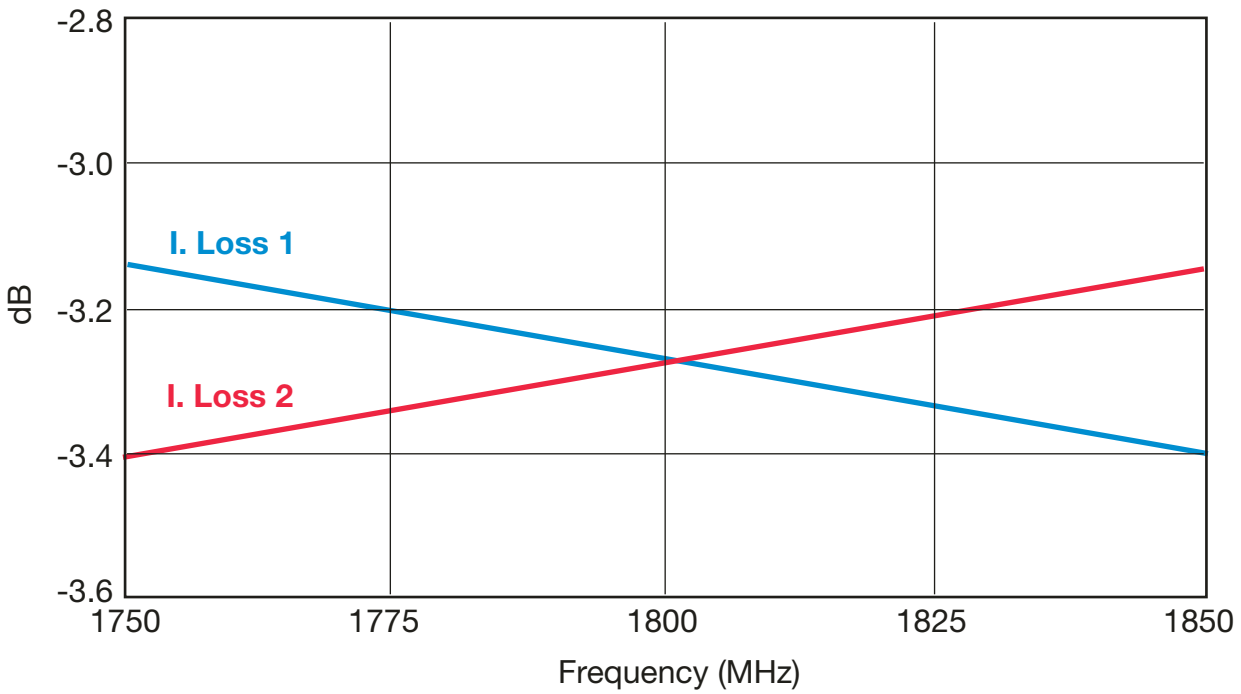

3

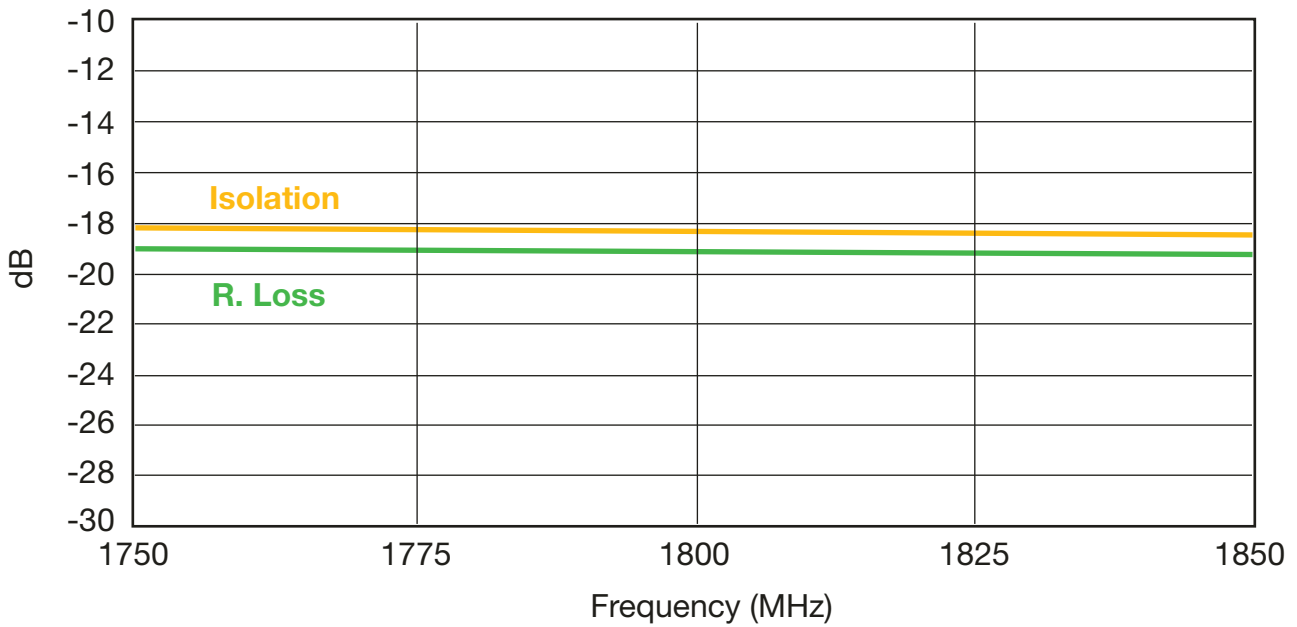

Thin-Film Directional Couplers

DB0805 3dB 90° Couplers



1850 ± 50MHz DB0805A1850AWTR

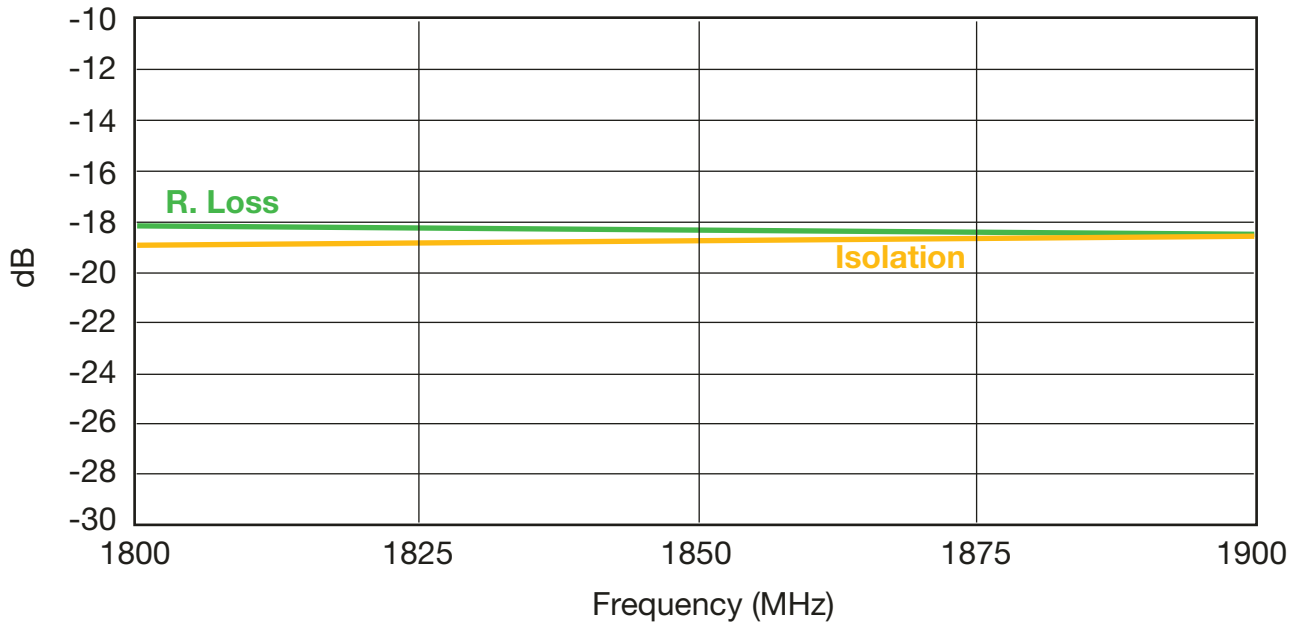
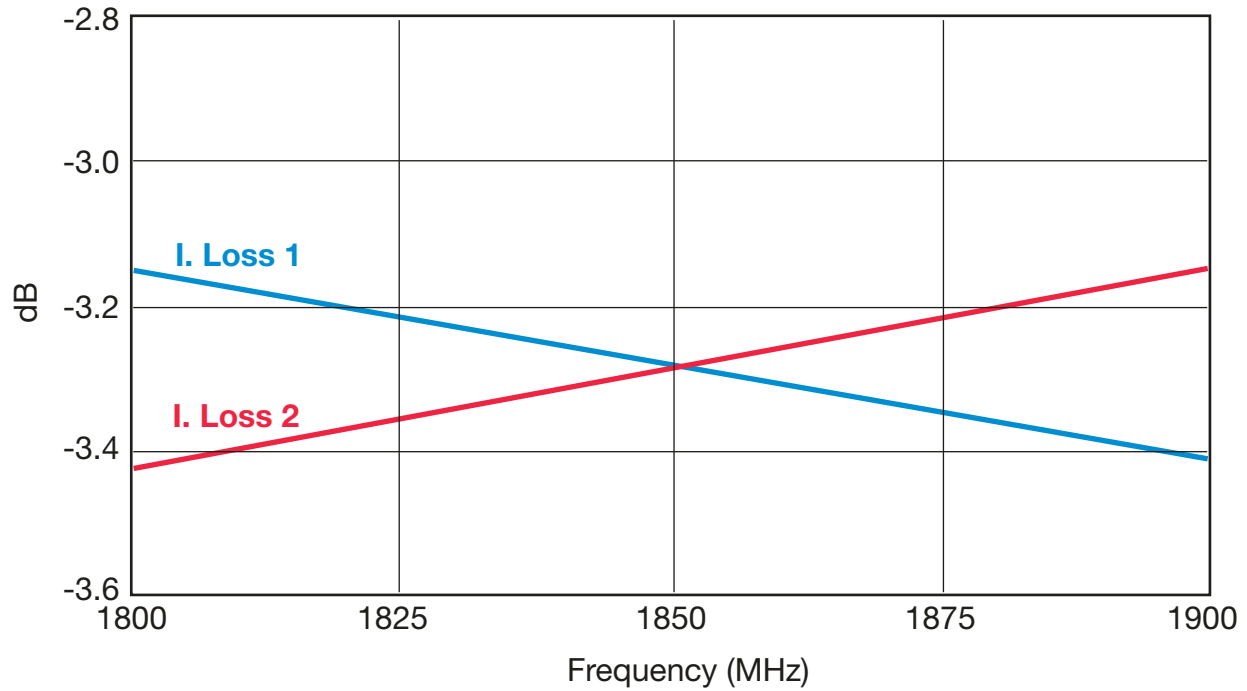

Thin-Film Directional Couplers

DB0805 3dB 90° Couplers



1900 ± 50MHz DB0805A1900AWTR

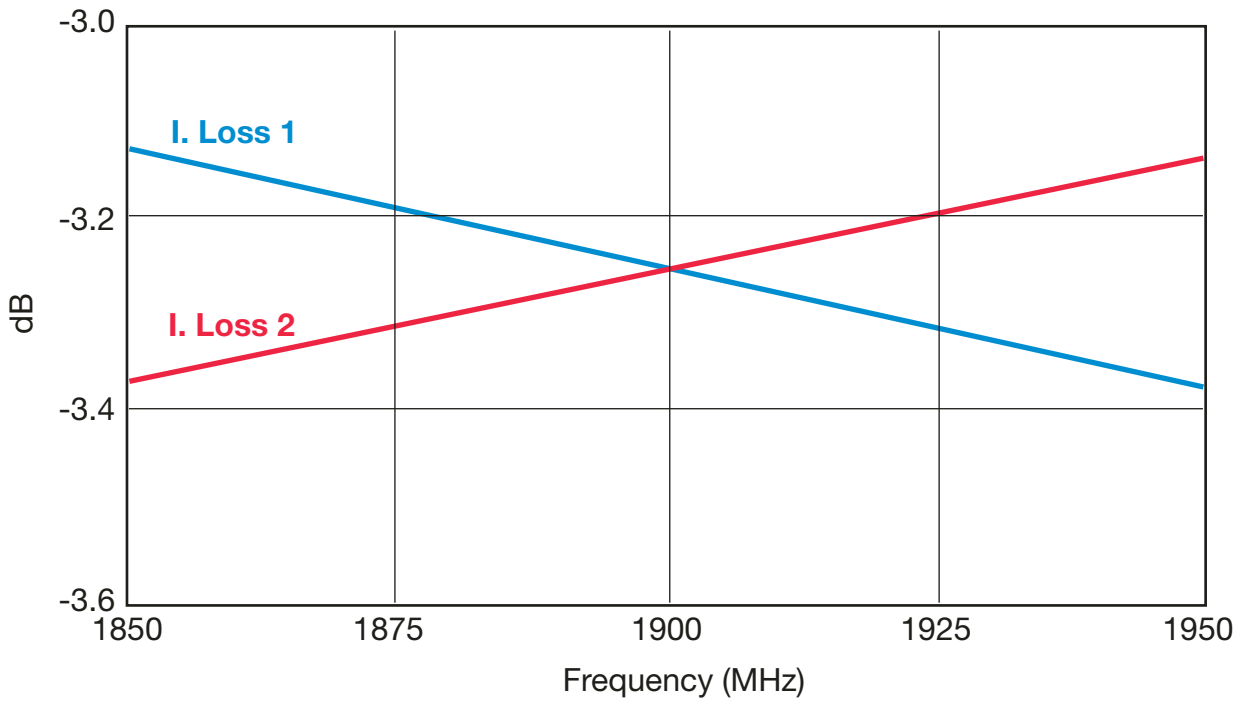

3

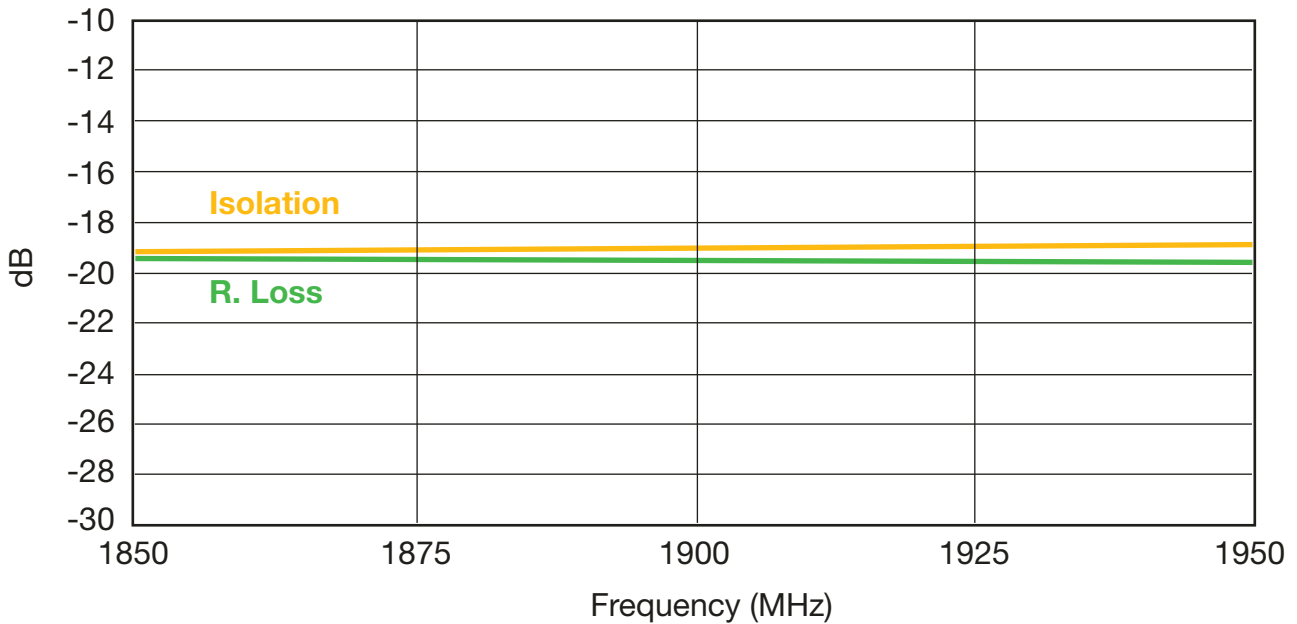

Thin-Film Directional Couplers

DB0805 3dB 90° Couplers



1950 ± 50MHz DB0805A1950AWTR

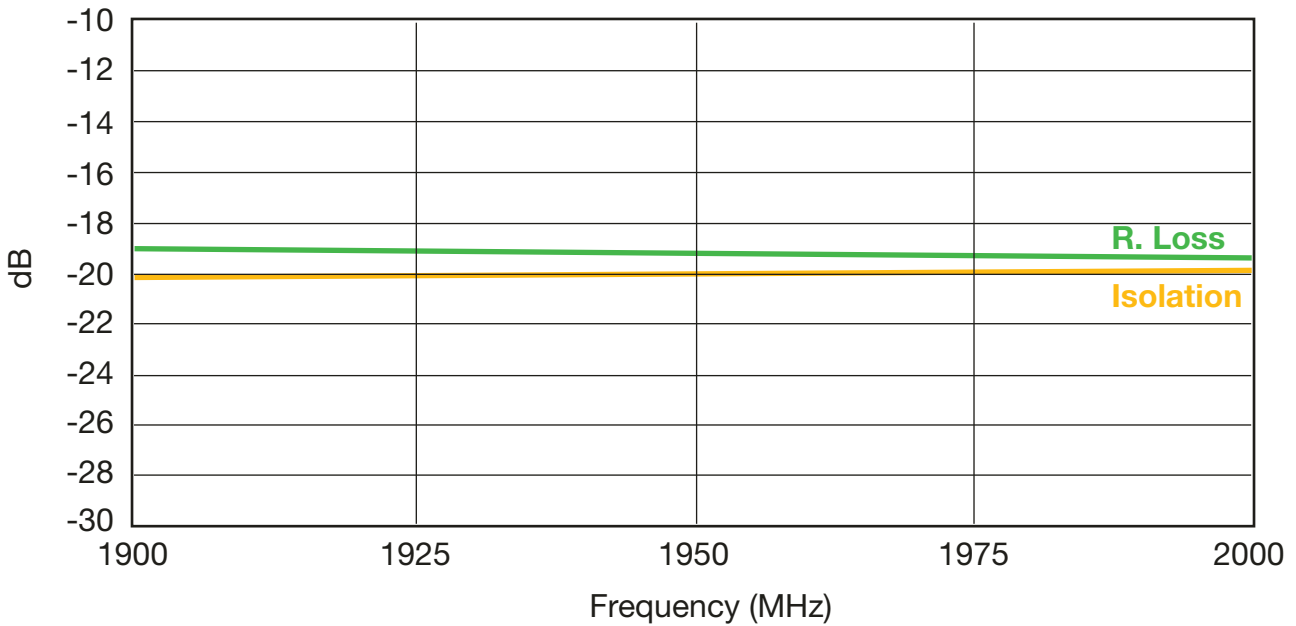
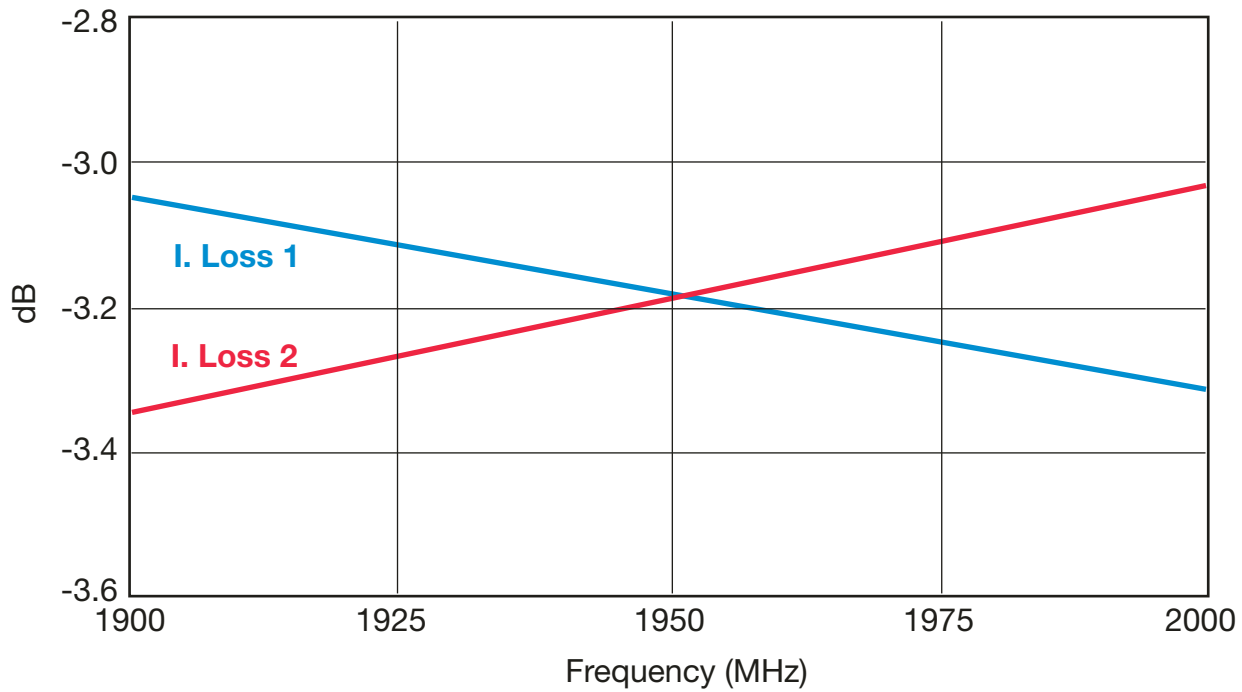

3

Thin-Film Directional Couplers

DB0805 3dB 90° Couplers



2140 ± 50MHz DB0805A2140AWTR

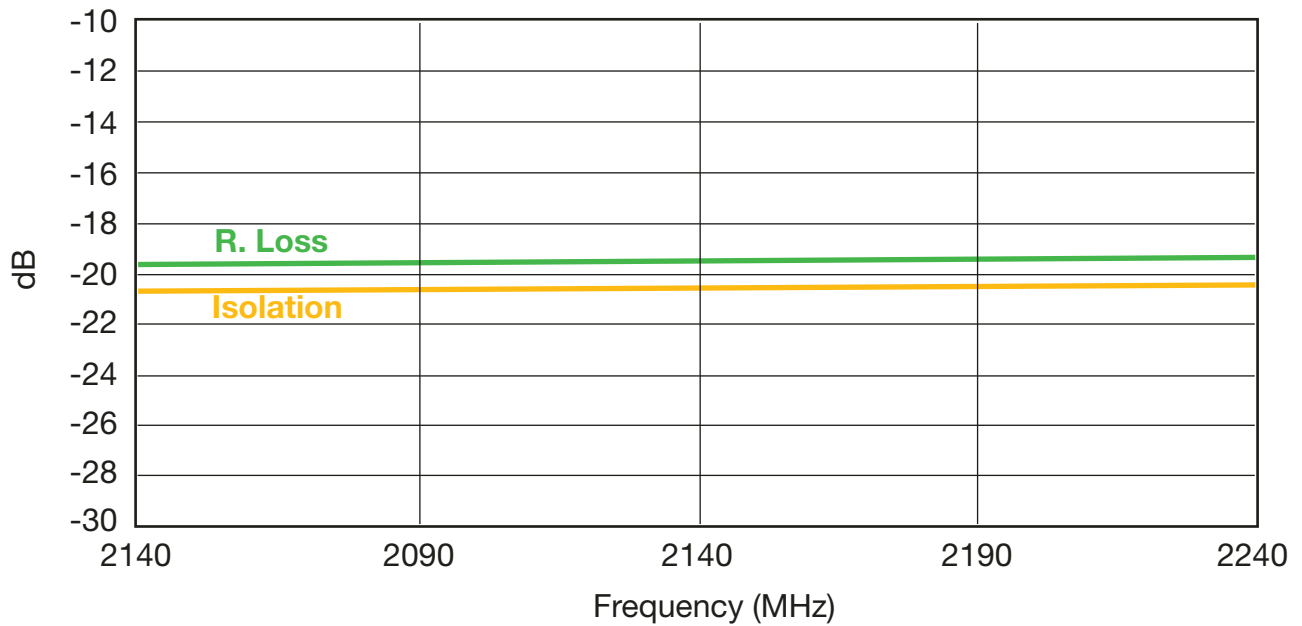
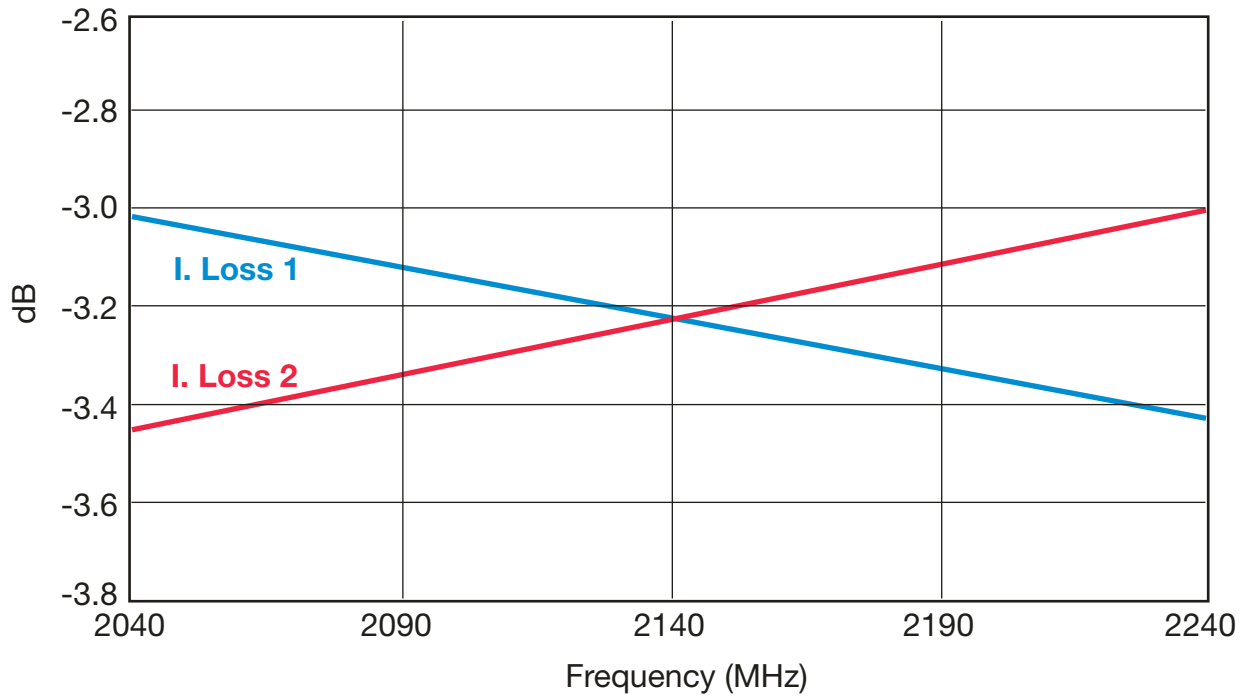

3

Thin-Film Directional Couplers

DB0805 3dB 90° Couplers



2325 ± 50MHz DB0805A2325AWTR

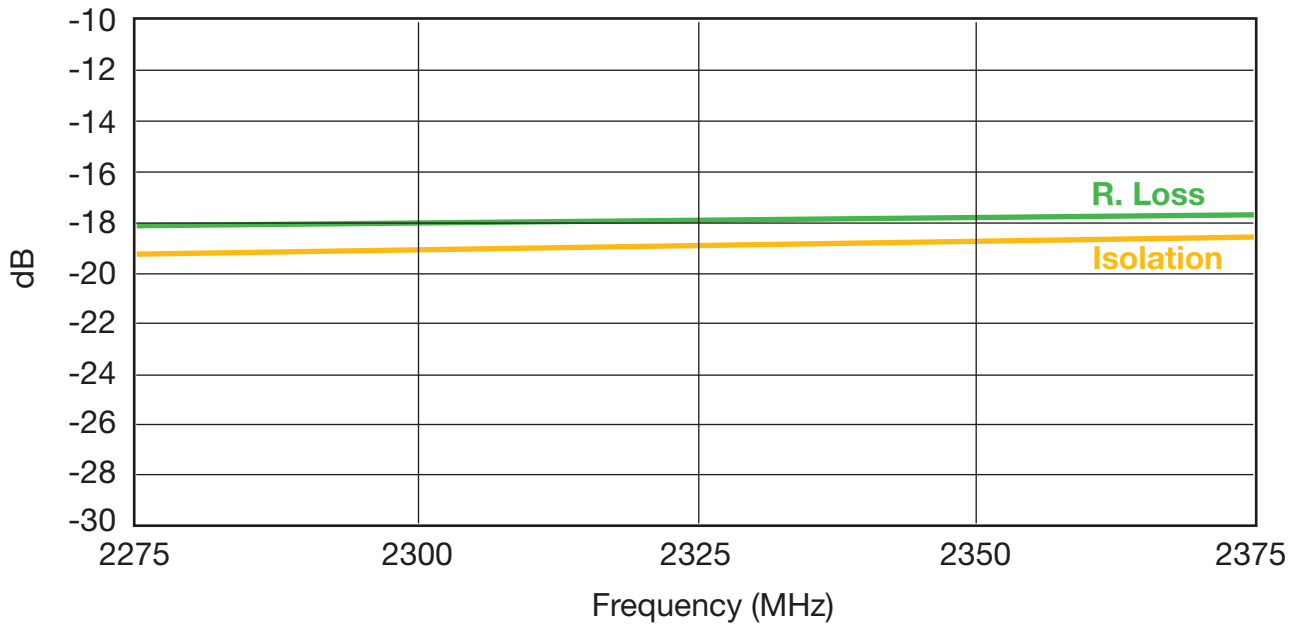
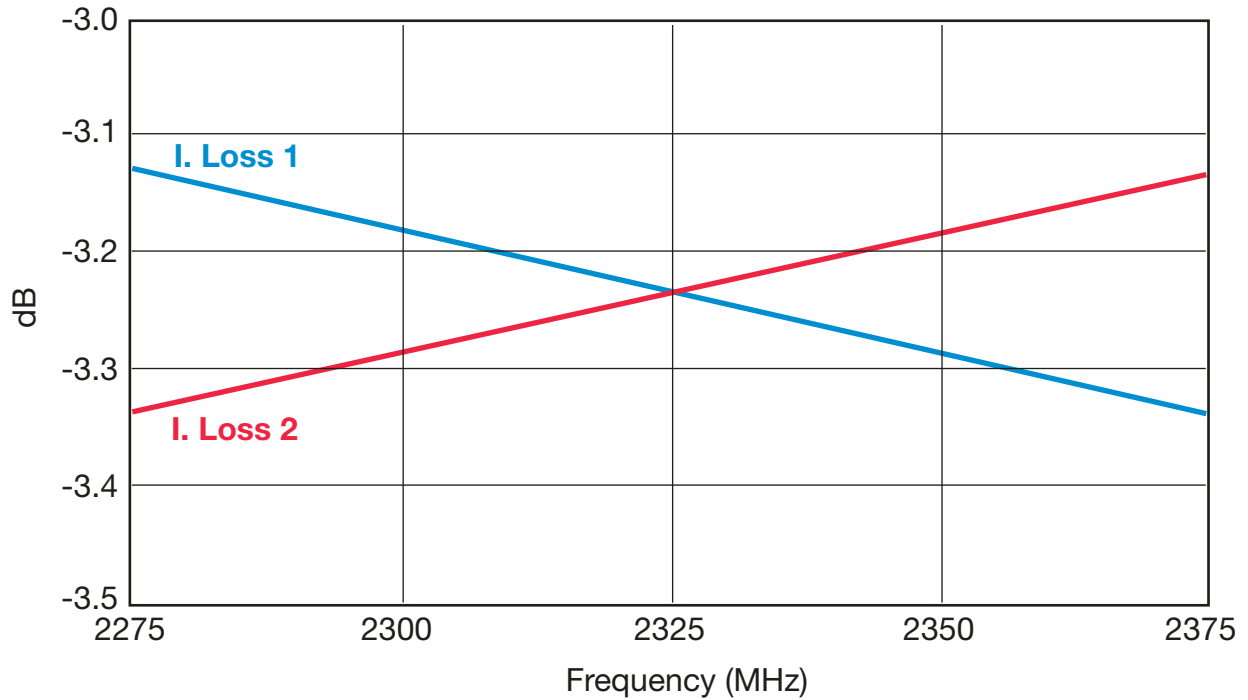

3

DB0805 3dB 90° Test Jigs

GENERAL DESCRIPTION

These jigs are designed for testing the DB0805 3dB 90° Couplers using a Vector Network Analyzer.

They consist of a dielectric substrate, having 50Ω microstrips as conducting lines and a bottom ground plane located at a distance of 0.254mm from the microstrips.

The substrate used is Neltec's NH9338ST0254C1BC.

The connectors are SMA type (female), 'Johnson Components Inc.' Product P/N: 142-0701-841.

Both a measurement jig and a calibration jig are provided.

The calibration jig is designed for a full 2-port calibration, and consists of an open line, short line and through line. LOAD calibration can be done by a 50Ω SMA termination.

MEASUREMENT PROCEDURE

When measuring a component, it can be either soldered or pressed using a non-metallic stick until all four ports touch the appropriate pads. Set the VNA to the relevant frequency band. Connect the VNA using a 10dB attenuator on the jig

terminal connected to port 2. Follow the VNA's instruction manual and use the [calibration jig](#) to perform a full 2-port calibration in the required bandwidths.

Place the coupler on the [measurement jig](#) as follows:

Input (Coupler) ◀ Connector 1 (Jig)	Output 1 (Coupler) ◀ Connector 3 (Jig)
50Ω (Coupler) ◀ Connector 2 (Jig)	Output 2 (Coupler) ◀ Connector 4 (Jig)

To measure [R. Loss](#) and [I. Loss 1](#) connect:

Connector 1 (Jig) ◀ Port 1 (VNA)	Connector 3 (Jig) ◀ Port 2 (VNA)
Connector 2 (Jig) ◀ 50Ω	Connector 4 (Jig) ◀ 50Ω

To measure [R. Loss](#) and [I. Loss 2](#) connect:

Connector 1 (Jig) ◀ Port 1 (VNA)	Connector 3 (Jig) ◀ 50Ω
Connector 2 (Jig) ◀ 50Ω	Connector 4 (Jig) ◀ Port 2 (VNA)

To measure [Isolation](#) connect:

Connector 1 (Jig) ◀ 50Ω	Connector 3 (Jig) ◀ Port 1 (VNA)
Connector 2 (Jig) ◀ 50Ω	Connector 4 (Jig) ◀ Port 2 (VNA)

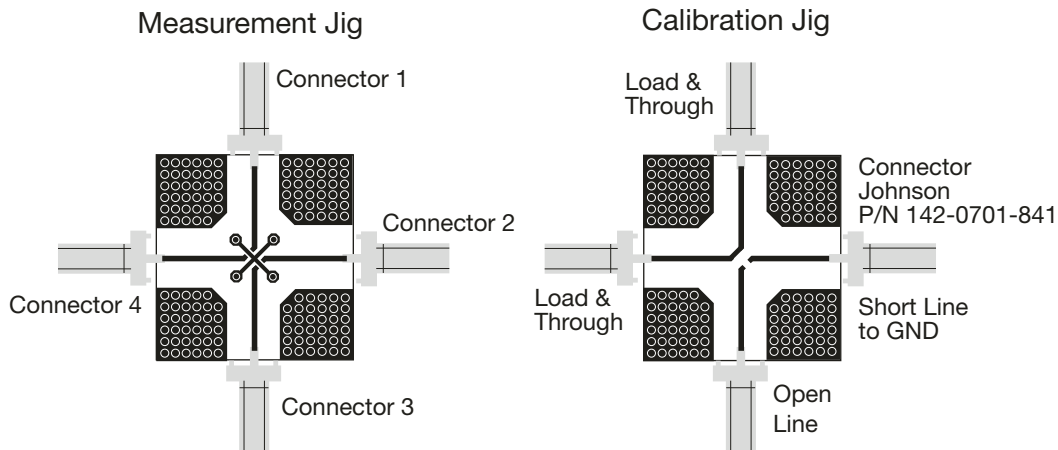



Компания «ЭлектроПласт» предлагает заключение долгосрочных отношений при поставках импортных электронных компонентов на взаимовыгодных условиях!

Наши преимущества:

- Оперативные поставки широкого спектра электронных компонентов отечественного и импортного производства напрямую от производителей и с крупнейших мировых складов;
- Поставка более 17-ти миллионов наименований электронных компонентов;
- Поставка сложных, дефицитных, либо снятых с производства позиций;
- Оперативные сроки поставки под заказ (от 5 рабочих дней);
- Экспресс доставка в любую точку России;
- Техническая поддержка проекта, помощь в подборе аналогов, поставка прототипов;
- Система менеджмента качества сертифицирована по Международному стандарту ISO 9001;
- Лицензия ФСБ на осуществление работ с использованием сведений, составляющих государственную тайну;
- Поставка специализированных компонентов (Xilinx, Altera, Analog Devices, Intersil, Interpoint, Microsemi, Aeroflex, Peregrine, Syfer, Eurofarad, Texas Instrument, Miteq, Cobham, E2V, MA-COM, Hittite, Mini-Circuits, General Dynamics и др.);

Помимо этого, одним из направлений компании «ЭлектроПласт» является направление «Источники питания». Мы предлагаем Вам помощь Конструкторского отдела:

- Подбор оптимального решения, техническое обоснование при выборе компонента;
- Подбор аналогов;
- Консультации по применению компонента;
- Поставка образцов и прототипов;
- Техническая поддержка проекта;
- Защита от снятия компонента с производства.



Как с нами связаться

Телефон: 8 (812) 309 58 32 (многоканальный)

Факс: 8 (812) 320-02-42

Электронная почта: org@eplast1.ru

Адрес: 198099, г. Санкт-Петербург, ул. Калинина, дом 2, корпус 4, литера А.