

Parameters	Ratings	Units
Peak Blocking Voltage	350	V_p
Load Current	130	mA_{rms} / mA_{DC}
On-Resistance (max)	30	Ω
Isolation Voltage, Input to Output	5000	V_{rms}

Features

- 5000V_{rms} Input/Output Isolation
- 350V_p Blocking Voltage
- Low Drive Power Requirements
- Arc-Free With No Snubbing Circuits
- No EMI/RFI Generation
- Small 4-Pin Package
- Flammability Rating UL 94 V-0

Applications

- Telephony Switching
- Instrumentation
- Multiplexers
- Data Acquisition
- Electronic Switching
- I/O Subsystems
- Meters (Watt-Hour, Water, Gas)
- Medical Equipment—Patient/Equipment Isolation
- Security
- Aerospace
- Industrial Controls

Description

The CPC1333G is a single-pole, normally closed (1-Form-B) Solid State Relay with an enhanced input to output isolation barrier of 5000V_{rms}.

The relay output is constructed with efficient MOSFET switches that use IXYS Integrated Circuits' patented OptoMOS architecture. The input, a highly efficient infrared LED, controls the optically coupled output.

Approvals

- UL Recognized Component: File E76270
- EN/IEC 60950-1 Certified Component:
Certificate available on our website

Ordering Information

Part Number	Description
CPC1333G	4-Pin DIP (100/Tube)
CPC1333GR	4-Pin Surface Mount (100/Tube)
CPC1333GRTR	4-Pin Surface Mount (1000/Reel)

Pin Configuration

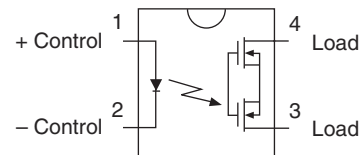

Switching Characteristics of Normally Closed Devices

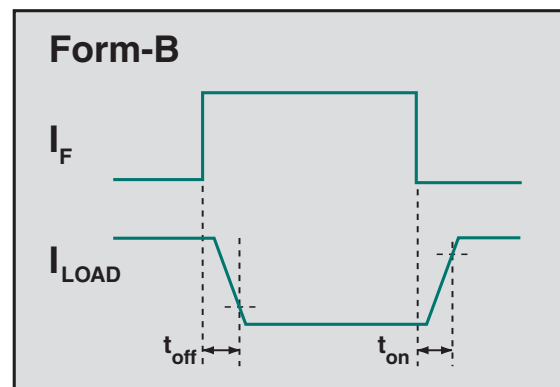

Absolute Maximum Ratings @ 25°C

Parameter	Ratings	Units
Peak Blocking Voltage	350	V _P
Reverse Input Voltage	5	V
Input Control Current	50	mA
Peak (10ms)	1	A
Input Power Dissipation ¹	100	mW
Total Package Dissipation ²	550	mW
Isolation Voltage, Input to Output	5000	V _{rms}
ESD Rating, Human Body Model	8	kV
Operational Temperature	-40 to +85	°C
Storage Temperature	-40 to +125	°C

¹ Derate linearly 1.33mW / °C

² Derate linearly 3mW / °C

Absolute Maximum Ratings are stress ratings. Stresses in excess of these ratings can cause permanent damage to the device. Functional operation of the device at conditions beyond those indicated in the operational sections of this data sheet is not implied.

Typical values are characteristic of the device at +25°C, and are the result of engineering evaluations. They are provided for information purposes only, and are not part of the manufacturing testing requirements.

Electrical Characteristics @ 25°C

Parameters	Conditions	Symbol	Min	Typ	Max	Units
Output Characteristics						
Load Current						
Continuous	-	I _L	-	-	130	mA _{rms} / mA _{DC}
Peak	t=10ms	I _{LPK}	-	-	±350	mA _p
On-Resistance ¹	I _L =130mA	R _{ON}	-	25	30	Ω
Off-State Leakage Current	I _F =2mA, V _L =350V	I _{LEAK}	-	-	1	μA
Switching Speeds						
Turn-On Output (Deactivate)	I _F =5mA, V _L =10V	t _{on}	-	-	2	ms
Turn-Off Output (Activate)		t _{off}	-	-	3	
Output Capacitance	I _F =2mA, V _L =50V, f=1MHz	C _{OUT}	-	6	-	pF
Input Characteristics						
Input Control Current to Activate ²	-	I _F	-	0.18	2	mA
Input Control Current to Deactivate	I _L =130mA	I _F	0.1	-	-	mA
Input Voltage Drop	I _F =5mA	V _F	0.9	1.26	1.5	V
Reverse Input Current	V _R =5V	I _R	-	-	10	μA
Common Characteristics						
Capacitance, Input to Output	V _{IO} =0V, f=1MHz	C _{IO}	-	3	-	pF

¹ Measurement taken within one second of on-time.

² For high temperature operation (>60°C), IXYS Integrated Circuits recommends a minimum LED drive current of 5mA.

Timing Diagram

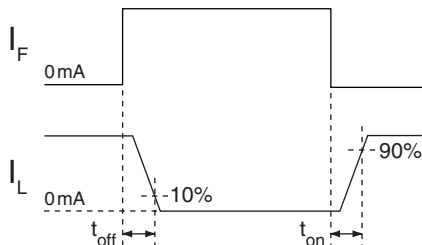

CPC1333G Isolation Test Circuit

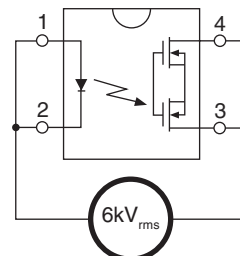

Test Conditions:
 Voltage Ramp: 2V/μs
 Test Time: 2 Seconds
 I_{LEAK} Threshold: 50μA
 Test Voltage: 6kV_{rms}

PERFORMANCE DATA*

Typical LED Forward Voltage Drop
(N=50, $I_F=5\text{mA}$)

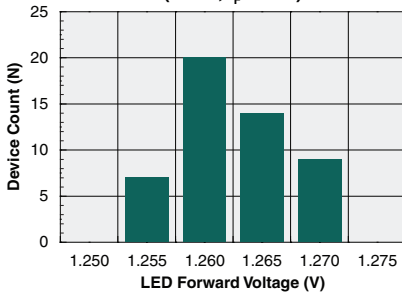

Typical Turn-On Time
(N=50, $I_F=5\text{mA}$, $I_L=60\text{mA}$)

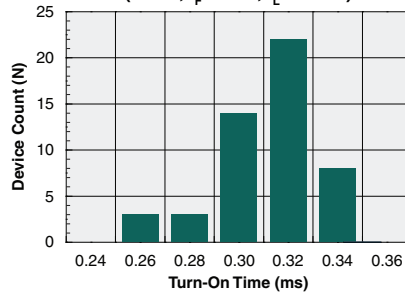

Typical Turn-Off Time
(N=50, $I_F=5\text{mA}$, $I_L=60\text{mA}$)

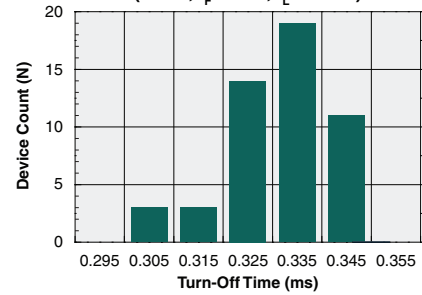

Typical I_F for Switch Operation
(N=50, $I_L=130\text{mA}$)

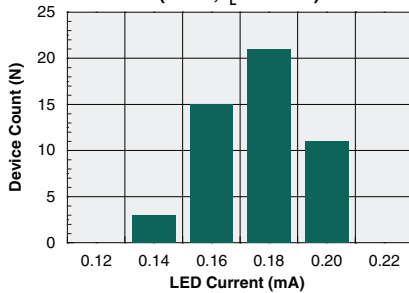

Typical On-Resistance Distribution
(N=50, $I_F=0\text{mA}$, $I_L=130\text{mA}$)

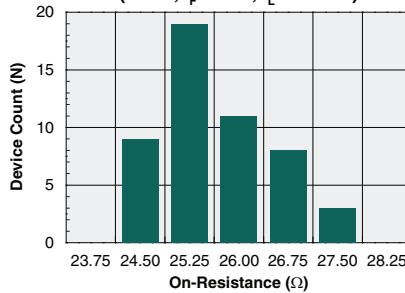

Typical Blocking Voltage Distribution
(N=50, $I_F=2\text{mA}$)

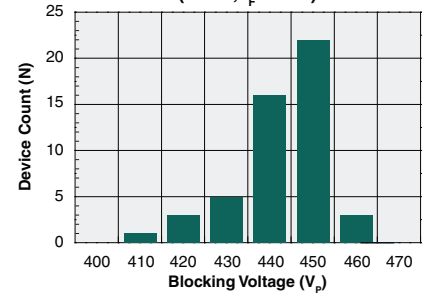

Typical LED Forward Voltage Drop vs. Temperature

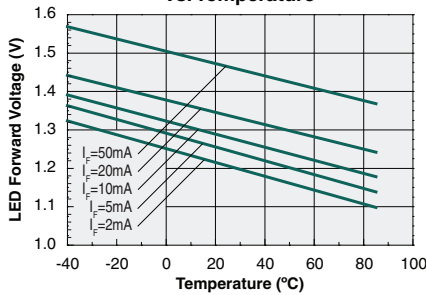

Typical Turn-On Time vs. LED Forward Current
($I_L=60\text{mA}$)

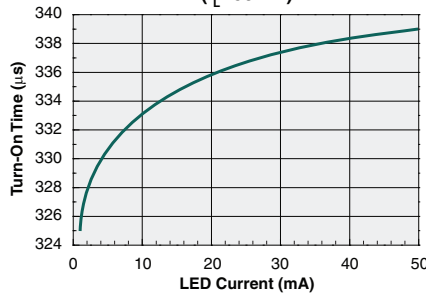

Typical Turn-Off Time vs. LED Forward Current
($I_L=60\text{mA}$)

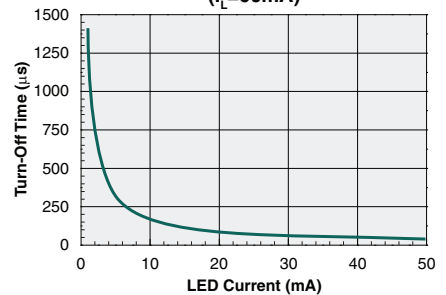

Typical I_F for Switch Operation vs. Temperature
($I_L=60\text{mA}$)

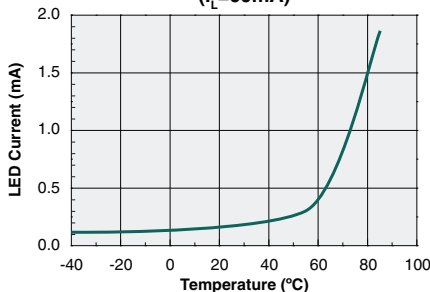

Typical Turn-On Time vs. Temperature
($I_L=60\text{mA}$)

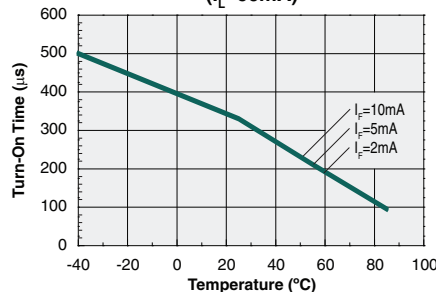

Typical Turn-Off Time vs. Temperature
($I_L=60\text{mA}$)

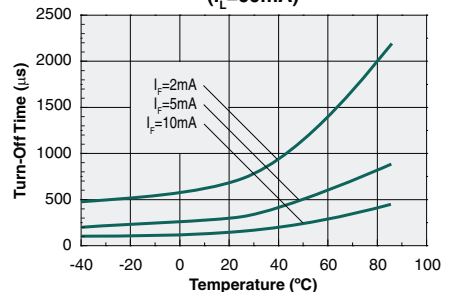

*Unless otherwise noted, data presented in these graphs is typical of device operation at 25°C. For guaranteed parameters not indicated in the written specifications, please contact our application department.

PERFORMANCE DATA*

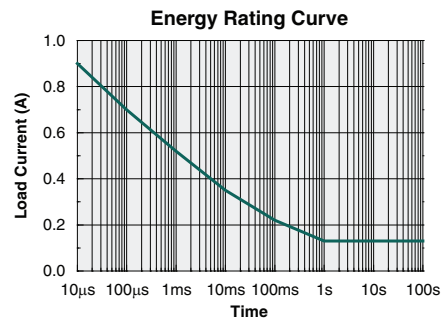
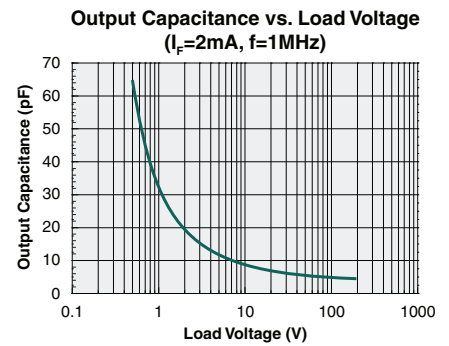
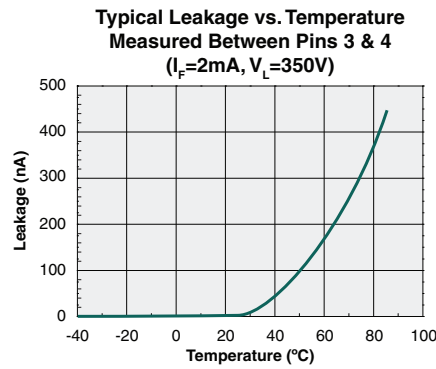
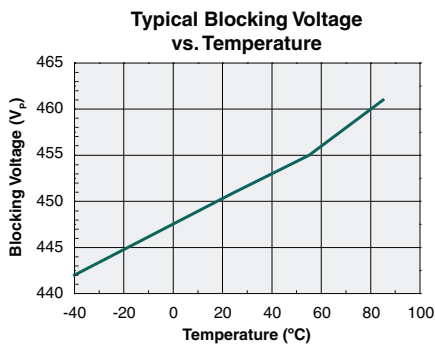
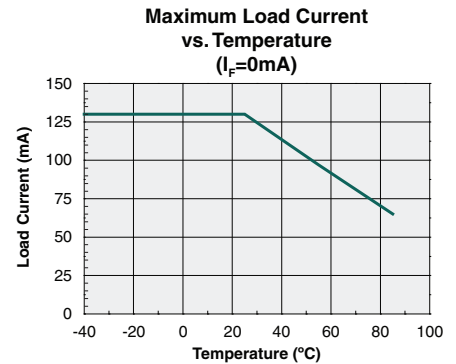
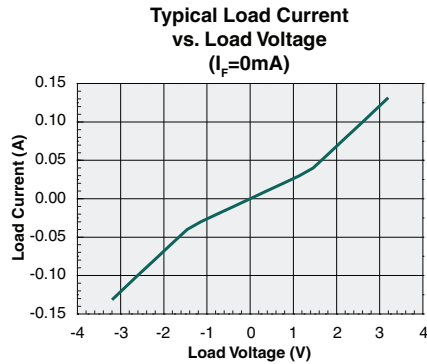
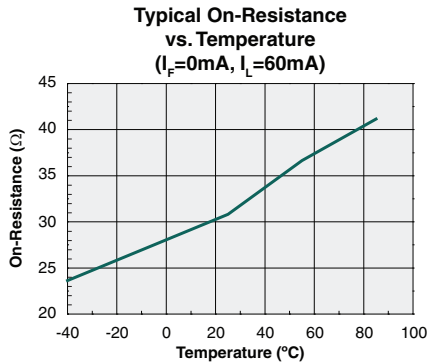

*Unless otherwise noted, data presented in these graphs is typical of device operation at 25°C.
For guaranteed parameters not indicated in the written specifications, please contact our application department.

Manufacturing Information

Moisture Sensitivity



All plastic encapsulated semiconductor packages are susceptible to moisture ingress. IXYS Integrated Circuits classifies its plastic encapsulated devices for moisture sensitivity according to the latest version of the joint industry standard, **IPC/JEDEC J-STD-020**, in force at the time of product evaluation. We test all of our products to the maximum conditions set forth in the standard, and guarantee proper operation of our devices when handled according to the limitations and information in that standard as well as to any limitations set forth in the information or standards referenced below.

Failure to adhere to the warnings or limitations as established by the listed specifications could result in reduced product performance, reduction of operable life, and/or reduction of overall reliability.

This product carries a Moisture Sensitivity Level (MSL) classification as shown below, and should be handled according to the requirements of the latest version of the joint industry standard **IPC/JEDEC J-STD-033**.

Device	Moisture Sensitivity Level (MSL) Classification
CPC1333G	MSL 1
CPC1333GR	MSL 3

ESD Sensitivity



This product is **ESD Sensitive**, and should be handled according to the industry standard **JESD-625**.

Soldering Profile

Provided in the table below is the Classification Temperature (T_C) of this product and the maximum dwell time the body temperature of this device may be ($T_C - 5$)°C or greater. The classification temperature sets the Maximum Body Temperature allowed for this device during lead-free reflow processes. Additionally, for the CPC1333GR, the solder reflow profile given in Technical Brief TB-200 "**Pb-Free Solder Reflow Profile for Select Devices**" must be followed. For the through-hole device, CPC1333G, and any other processes, the guidelines of **J-STD-020** must be observed.

Device	Classification Temperature (T_C)	Dwell Time (t_p)	Max Reflow Cycles
CPC1333G	250°C	15 seconds	1
CPC1333GR	250°C	15 seconds	3

Board Wash

IXYS Integrated Circuits recommends the use of no-clean flux formulations. Board washing to reduce or remove flux residue following the solder reflow process is acceptable provided proper precautions are taken to prevent damage to the device. These precautions include, but are not limited to: using a low pressure wash and providing a follow up bake cycle sufficient to remove any moisture trapped within the device due to the washing process. Due to the variability of the wash parameters used to clean the board, determination of the bake temperature and duration necessary to remove the moisture trapped within the package is the responsibility of the user (assembler). Cleaning or drying methods that employ ultrasonic energy may damage the device and should not be used. Additionally, the device must not be exposed to flux or solvents that are Chlorine- or Fluorine-based.



Mechanical Dimensions

CPC1333GR

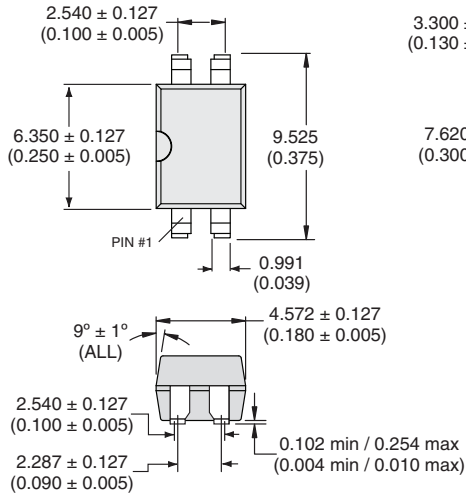

PCB Land Pattern

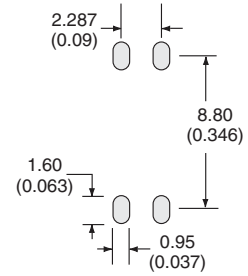

Dimensions
mm
(inches)

CPC1333GRTR Tape & Reel

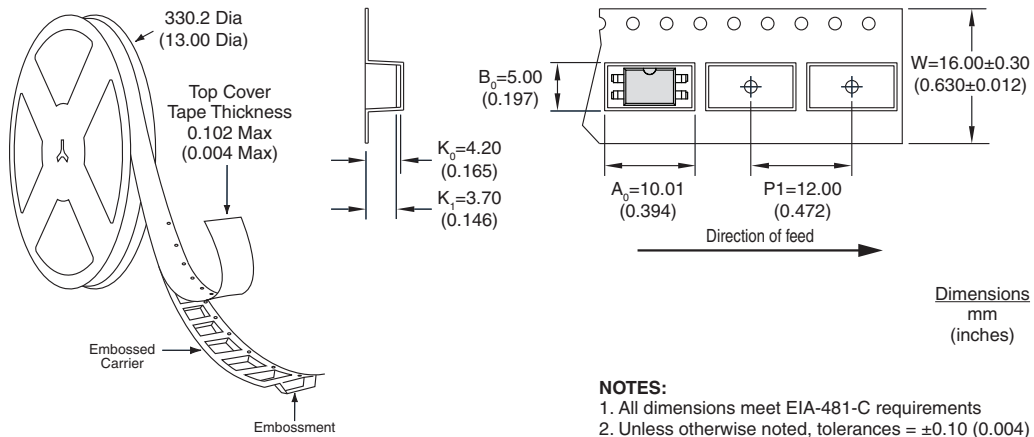

Dimensions
mm
(inches)

- NOTES:**
 1. All dimensions meet EIA-481-C requirements
 2. Unless otherwise noted, tolerances = ± 0.10 (0.004)

CPC1333G

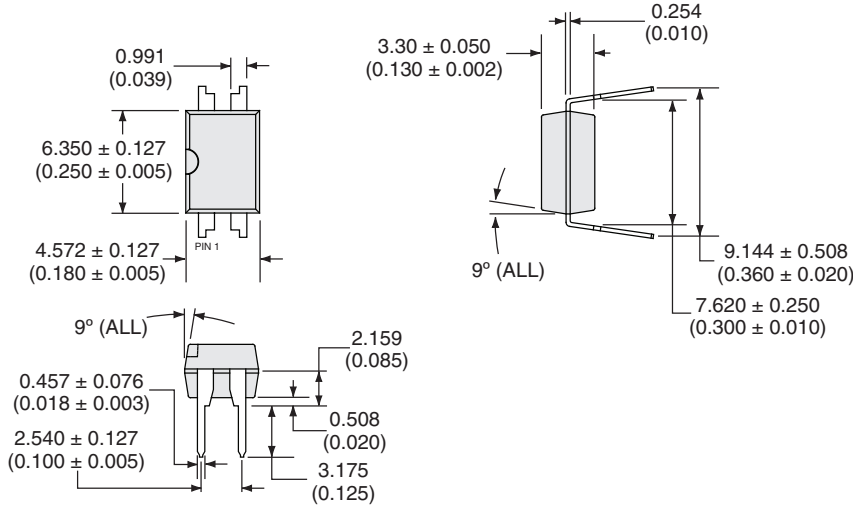

PC Board Pattern (Top View)

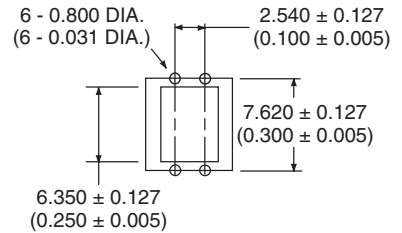

Dimensions
mm
(inches)

For additional information please visit our website at: www.ixysic.com

IXYS Integrated Circuits makes no representations or warranties with respect to the accuracy or completeness of the contents of this publication and reserves the right to make changes to specifications and product descriptions at any time without notice. Neither circuit patent licenses nor indemnity are expressed or implied. Except as set forth in IXYS Integrated Circuits' Standard Terms and Conditions of Sale, IXYS Integrated Circuits assumes no liability whatsoever, and disclaims any express or implied warranty, relating to its products including, but not limited to, the implied warranty of merchantability, fitness for a particular purpose, or infringement of any intellectual property right.

The products described in this document are not designed, intended, authorized or warranted for use as components in systems intended for surgical implant into the body, or in other applications intended to support or sustain life, or where malfunction of IXYS Integrated Circuits' product may result in direct physical harm, injury, or death to a person or severe property or environmental damage. IXYS Integrated Circuits reserves the right to discontinue or make changes to its products at any time without notice.



Компания «ЭлектроПласт» предлагает заключение долгосрочных отношений при поставках импортных электронных компонентов на взаимовыгодных условиях!

Наши преимущества:

- Оперативные поставки широкого спектра электронных компонентов отечественного и импортного производства напрямую от производителей и с крупнейших мировых складов;
- Поставка более 17-ти миллионов наименований электронных компонентов;
- Поставка сложных, дефицитных, либо снятых с производства позиций;
- Оперативные сроки поставки под заказ (от 5 рабочих дней);
- Экспресс доставка в любую точку России;
- Техническая поддержка проекта, помощь в подборе аналогов, поставка прототипов;
- Система менеджмента качества сертифицирована по Международному стандарту ISO 9001;
- Лицензия ФСБ на осуществление работ с использованием сведений, составляющих государственную тайну;
- Поставка специализированных компонентов (Xilinx, Altera, Analog Devices, Intersil, Interpoint, Microsemi, Aeroflex, Peregrine, Syfer, Eurofarad, Texas Instrument, Miteq, Cobham, E2V, MA-COM, Hittite, Mini-Circuits, General Dynamics и др.);

Помимо этого, одним из направлений компании «ЭлектроПласт» является направление «Источники питания». Мы предлагаем Вам помощь Конструкторского отдела:

- Подбор оптимального решения, техническое обоснование при выборе компонента;
- Подбор аналогов;
- Консультации по применению компонента;
- Поставка образцов и прототипов;
- Техническая поддержка проекта;
- Защита от снятия компонента с производства.



Как с нами связаться

Телефон: 8 (812) 309 58 32 (многоканальный)

Факс: 8 (812) 320-02-42

Электронная почта: org@eplast1.ru

Адрес: 198099, г. Санкт-Петербург, ул. Калинина, дом 2, корпус 4, литера А.