



Is Now Part of



ON Semiconductor®

To learn more about ON Semiconductor, please visit our website at
www.onsemi.com

Please note: As part of the Fairchild Semiconductor integration, some of the Fairchild orderable part numbers will need to change in order to meet ON Semiconductor's system requirements. Since the ON Semiconductor product management systems do not have the ability to manage part nomenclature that utilizes an underscore (_), the underscore (_) in the Fairchild part numbers will be changed to a dash (-). This document may contain device numbers with an underscore (_). Please check the ON Semiconductor website to verify the updated device numbers. The most current and up-to-date ordering information can be found at www.onsemi.com. Please email any questions regarding the system integration to Fairchild_questions@onsemi.com.

ON Semiconductor and the ON Semiconductor logo are trademarks of Semiconductor Components Industries, LLC dba ON Semiconductor or its subsidiaries in the United States and/or other countries. ON Semiconductor owns the rights to a number of patents, trademarks, copyrights, trade secrets, and other intellectual property. A listing of ON Semiconductor's product/patent coverage may be accessed at www.onsemi.com/site/pdf/Patent-Marking.pdf. ON Semiconductor reserves the right to make changes without further notice to any products herein. ON Semiconductor makes no warranty, representation or guarantee regarding the suitability of its products for any particular purpose, nor does ON Semiconductor assume any liability arising out of the application or use of any product or circuit, and specifically disclaims any and all liability, including without limitation special, consequential or incidental damages. Buyer is responsible for its products and applications using ON Semiconductor products, including compliance with all laws, regulations and safety requirements or standards, regardless of any support or applications information provided by ON Semiconductor. "Typical" parameters which may be provided in ON Semiconductor data sheets and/or specifications can and do vary in different applications and actual performance may vary over time. All operating parameters, including "Typicals" must be validated for each customer application by customer's technical experts. ON Semiconductor does not convey any license under its patent rights nor the rights of others. ON Semiconductor products are not designed, intended, or authorized for use as a critical component in life support systems or any FDA Class 3 medical devices or medical devices with a same or similar classification in a foreign jurisdiction or any devices intended for implantation in the human body. Should Buyer purchase or use ON Semiconductor products for any such unintended or unauthorized application, Buyer shall indemnify and hold ON Semiconductor and its officers, employees, subsidiaries, affiliates, and distributors harmless against all claims, costs, damages, and expenses, and reasonable attorney fees arising out of, directly or indirectly, any claim of personal injury or death associated with such unintended or unauthorized use, even if such claim alleges that ON Semiconductor was negligent regarding the design or manufacture of the part. ON Semiconductor is an Equal Opportunity/Affirmative Action Employer. This literature is subject to all applicable copyright laws and is not for resale in any manner.

Single-Channel: 6N137, HCPL2601, HCPL2611 Dual-Channel: HCPL2630, HCPL2631 High Speed 10MBit/s Logic Gate Optocouplers

Features

- Very high speed – 10 MBit/s
- Superior CMR – 10 kV/μs
- Double working voltage-480V
- Fan-out of 8 over -40°C to +85°C
- Logic gate output
- Strobable output
- Wired OR-open collector
- U.L. recognized (File # E90700)

Applications

- Ground loop elimination
- LSTTL to TTL, LSTTL or 5-volt CMOS
- Line receiver, data transmission
- Data multiplexing
- Switching power supplies
- Pulse transformer replacement
- Computer-peripheral interface

Description

The 6N137, HCPL2601, HCPL2611 single-channel and HCPL2630, HCPL2631 dual-channel optocouplers consist of a 850 nm AlGaAs LED, optically coupled to a very high speed integrated photo-detector logic gate with a strobable output. This output features an open collector, thereby permitting wired OR outputs. The coupled parameters are guaranteed over the temperature range of -40°C to +85°C. A maximum input signal of 5mA will provide a minimum output sink current of 13mA (fan out of 8).

An internal noise shield provides superior common mode rejection of typically 10kV/μs. The HCPL2601 and HCPL2631 has a minimum CMR of 5kV/μs. The HCPL2611 has a minimum CMR of 10kV/μs.

Schematics



A 0.1μF bypass capacitor must be connected between pins 8 and 5⁽¹⁾.

Package Outlines

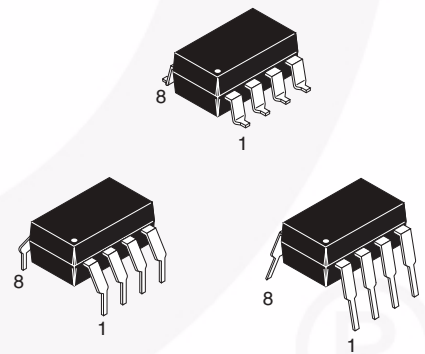

Truth Table (Positive Logic)

Input	Enable	Output
H	H	L
L	H	H
H	L	H
L	L	H
H	NC	L
L	NC	H

Absolute Maximum Ratings ($T_A = 25^\circ\text{C}$ unless otherwise specified)

Stresses exceeding the absolute maximum ratings may damage the device. The device may not function or be operable above the recommended operating conditions and stressing the parts to these levels is not recommended. In addition, extended exposure to stresses above the recommended operating conditions may affect device reliability. The absolute maximum ratings are stress ratings only.

Symbol	Parameter		Value	Units
T_{STG}	Storage Temperature		-55 to +125	$^\circ\text{C}$
T_{OPR}	Operating Temperature		-40 to +85	$^\circ\text{C}$
T_{SOL}	Lead Solder Temperature (for wave soldering only)*		260 for 10 sec	$^\circ\text{C}$
EMITTER				
I_F	DC/Average Forward	Single Channel	50	mA
	Input Current	Dual Channel (Each Channel)	30	
V_E	Enable Input Voltage Not to Exceed V_{CC} by more than 500mV	Single Channel	5.5	V
V_R	Reverse Input Voltage	Each Channel	5.0	V
P_I	Power Dissipation	Single Channel	100	mW
		Dual Channel (Each Channel)	45	
DETECTOR				
V_{CC} (1 minute max)	Supply Voltage		7.0	V
I_O	Output Current	Single Channel	50	mA
		Dual Channel (Each Channel)	50	
V_O	Output Voltage	Each Channel	7.0	V
P_O	Collector Output	Single Channel	85	mW
	Power Dissipation	Dual Channel (Each Channel)	60	

*For peak soldering reflow, please refer to the Reflow Profile on page 11.

Recommended Operating Conditions

The Recommended Operating Conditions table defines the conditions for actual device operation. Recommended operating conditions are specified to ensure optimal performance to the datasheet specifications. Fairchild does not recommend exceeding them or designing to absolute maximum ratings.

Symbol	Parameter	Min.	Max.	Units
I_{FL}	Input Current, Low Level	0	250	μA
I_{FH}	Input Current, High Level	*6.3	15	mA
V_{CC}	Supply Voltage, Output	4.5	5.5	V
V_{EL}	Enable Voltage, Low Level	0	0.8	V
V_{EH}	Enable Voltage, High Level	2.0	V_{CC}	V
T_A	Low Level Supply Current	-40	+85	$^\circ\text{C}$
N	Fan Out (TTL load)		8	

*6.3mA is a guard banded value which allows for at least 20% CTR degradation. Initial input current threshold value is 5.0mA or less.

Electrical Characteristics ($T_A = 0$ to 70°C unless otherwise specified)**Individual Component Characteristics**

Symbol	Parameter	Test Conditions	Min.	Typ.*	Max.	Unit	
EMITTER							
V_F	Input Forward Voltage	$I_F = 10\text{mA}$ $T_A = 25^\circ\text{C}$			1.8	V	
				1.4	1.75		
B_{VR}	Input Reverse Breakdown Voltage	$I_R = 10\mu\text{A}$	5.0			V	
C_{IN}	Input Capacitance	$V_F = 0, f = 1\text{MHz}$		60		pF	
$\Delta V_F / \Delta T_A$	Input Diode Temperature Coefficient	$I_F = 10\text{mA}$		-1.4		mV/ $^\circ\text{C}$	
DETECTOR							
I_{CCH}	High Level Supply Current	$V_{CC} = 5.5\text{V}, I_F = 0\text{mA}, V_E = 0.5\text{V}$	Single Channel		7	10	mA
			Dual Channel		10	15	
I_{CCL}	Low Level Supply Current		Single Channel	$V_{CC} = 5.5\text{V}, I_F = 10\text{mA}$	9	13	mA
			Dual Channel	$V_E = 0.5\text{V}$	14	21	
I_{EL}	Low Level Enable Current	$V_{CC} = 5.5\text{V}, V_E = 0.5\text{V}$		-0.8	-1.6	mA	
I_{EH}	High Level Enable Current	$V_{CC} = 5.5\text{V}, V_E = 2.0\text{V}$		-0.6	-1.6	mA	
V_{EH}	High Level Enable Voltage	$V_{CC} = 5.5\text{V}, I_F = 10\text{mA}$	2.0			V	
V_{EL}	Low Level Enable Voltage	$V_{CC} = 5.5\text{V}, I_F = 10\text{mA}^{(3)}$			0.8	V	

Switching Characteristics ($T_A = -40^\circ\text{C}$ to $+85^\circ\text{C}$, $V_{CC} = 5\text{V}$, $I_F = 7.5\text{mA}$ unless otherwise specified)

Symbol	AC Characteristics	Test Conditions	Min.	Typ.*	Max.	Unit
T_{PLH}	Propagation Delay Time to Output HIGH Level	$R_L = 350\Omega, C_L = 15\text{pF}^{(4)}$ (Fig. 12) $T_A = 25^\circ\text{C}$	20	45	75	ns
					100	
T_{PHL}	Propagation Delay Time to Output LOW Level	$T_A = 25^\circ\text{C}^{(5)}$ $R_L = 350\Omega, C_L = 15\text{pF}$ (Fig. 12)	25	45	75	ns
					100	
$ T_{PHL} - T_{PLH} $	Pulse Width Distortion	$(R_L = 350\Omega, C_L = 15\text{pF})$ (Fig. 12)		3	35	ns
t_r	Output Rise Time (10–90%)	$R_L = 350\Omega, C_L = 15\text{pF}^{(6)}$ (Fig. 12)		50		ns
t_f	Output Rise Time (90–10%)	$R_L = 350\Omega, C_L = 15\text{pF}^{(7)}$ (Fig. 12)		12		ns
t_{ELH}	Enable Propagation Delay Time to Output HIGH Level	$I_F = 7.5\text{mA}, V_{EH} = 3.5\text{V}, R_L = 350\Omega, C_L = 15\text{pF}^{(8)}$ (Fig. 13)		20		ns
t_{EHL}	Enable Propagation Delay Time to Output LOW Level	$I_F = 7.5\text{mA}, V_{EH} = 3.5\text{V}, R_L = 350\Omega, C_L = 15\text{pF}^{(9)}$ (Fig. 13)		20		ns
ICM_H	Common Mode Transient Immunity (at Output HIGH Level)	$T_A = 25^\circ\text{C}, V_{CM} = 50\text{V}$ (Peak), $I_F = 0\text{mA}, V_{OH}$ (Min.) = $2.0\text{V}, R_L = 350\Omega^{(10)}$ (Fig. 14)	6N137, HCPL2630		10,000	V/ μs
			HCPL2601, HCPL2631		5000	
		$ V_{CM} = 400\text{V}$	HCPL2611	10,000	15,000	
ICM_L	Common Mode Transient Immunity (at Output LOW Level)	$R_L = 350\Omega, I_F = 7.5\text{mA}, V_{OL}$ (Max.) = $0.8\text{V}, T_A = 25^\circ\text{C}^{(11)}$ (Fig. 14)	6N137, HCPL2630		10,000	V/ μs
			HCPL2601, HCPL2631		5000	
		$ V_{CM} = 400\text{V}$	HCPL2611	10,000	15,000	

Electrical Characteristics (Continued)**Transfer Characteristics** ($T_A = -40$ to $+85^\circ\text{C}$ unless otherwise specified)

Symbol	DC Characteristics	Test Conditions	Min.	Typ.*	Max.	Unit
I_{OH}	HIGH Level Output Current	$V_{CC} = 5.5\text{V}$, $V_O = 5.5\text{V}$, $I_F = 250\mu\text{A}$, $V_E = 2.0\text{V}^{(2)}$			100	μA
V_{OL}	LOW Level Output Current	$V_{CC} = 5.5\text{V}$, $I_F = 5\text{mA}$, $V_E = 2.0\text{V}$, $I_{CL} = 13\text{mA}^{(2)}$.35	0.6	V
I_{FT}	Input Threshold Current	$V_{CC} = 5.5\text{V}$, $V_O = 0.6\text{V}$, $V_E = 2.0\text{V}$, $I_{OL} = 13\text{mA}$		3	5	mA

Isolation Characteristics ($T_A = -40^\circ\text{C}$ to $+85^\circ\text{C}$ unless otherwise specified.)

Symbol	Characteristics	Test Conditions	Min.	Typ.*	Max.	Unit
I_{I-O}	Input-Output Insulation Leakage Current	Relative humidity = 45%, $T_A = 25^\circ\text{C}$, $t = 5\text{s}$, $V_{I-O} = 3000\text{VDC}^{(12)}$			1.0*	μA
V_{ISO}	Withstand Insulation Test Voltage	$RH < 50\%$, $T_A = 25^\circ\text{C}$, $I_{I-O} \leq 2\mu\text{A}$, $t = 1\text{min.}^{(12)}$	2500			V_{RMS}
R_{I-O}	Resistance (Input to Output)	$V_{I-O} = 500\text{V}^{(12)}$		10^{12}		Ω
C_{I-O}	Capacitance (Input to Output)	$f = 1\text{MHz}^{(12)}$		0.6		pF

*All Typical at $V_{CC} = 5\text{V}$, $T_A = 25^\circ\text{C}$

Notes:

- The V_{CC} supply to each optoisolator must be bypassed by a $0.1\mu\text{F}$ capacitor or larger. This can be either a ceramic or solid tantalum capacitor with good high frequency characteristic and should be connected as close as possible to the package V_{CC} and GND pins of each device.
- Each channel.
- Enable Input – No pull up resistor required as the device has an internal pull up resistor.
- t_{PLH} – Propagation delay is measured from the 3.75mA level on the HIGH to LOW transition of the input current pulse to the 1.5V level on the LOW to HIGH transition of the output voltage pulse.
- t_{PHL} – Propagation delay is measured from the 3.75mA level on the LOW to HIGH transition of the input current pulse to the 1.5V level on the HIGH to LOW transition of the output voltage pulse.
- t_r – Rise time is measured from the 90% to the 10% levels on the LOW to HIGH transition of the output pulse.
- t_f – Fall time is measured from the 10% to the 90% levels on the HIGH to LOW transition of the output pulse.
- t_{ELH} – Enable input propagation delay is measured from the 1.5V level on the HIGH to LOW transition of the input voltage pulse to the 1.5V level on the LOW to HIGH transition of the output voltage pulse.
- t_{EHL} – Enable input propagation delay is measured from the 1.5V level on the LOW to HIGH transition of the input voltage pulse to the 1.5V level on the HIGH to LOW transition of the output voltage pulse.
- CM_H – The maximum tolerable rate of rise of the common mode voltage to ensure the output will remain in the HIGH state (i.e., $V_{OUT} > 2.0\text{V}$). Measured in volts per microsecond ($\text{V}/\mu\text{s}$).
- CM_L – The maximum tolerable rate of rise of the common mode voltage to ensure the output will remain in the LOW output state (i.e., $V_{OUT} < 0.8\text{V}$). Measured in volts per microsecond ($\text{V}/\mu\text{s}$).
- Device considered a two-terminal device: Pins 1, 2, 3 and 4 shorted together, and Pins 5, 6, 7 and 8 shorted together.

Typical Performance Curves

Fig.1 Low Level Output Voltage vs. Ambient Temperature

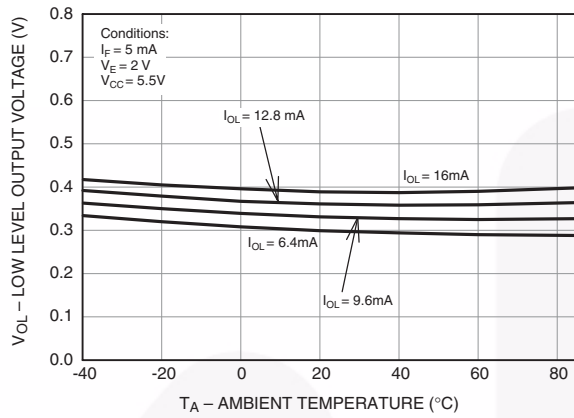

Fig. 2 Input Diode Forward Voltage vs. Forward Current

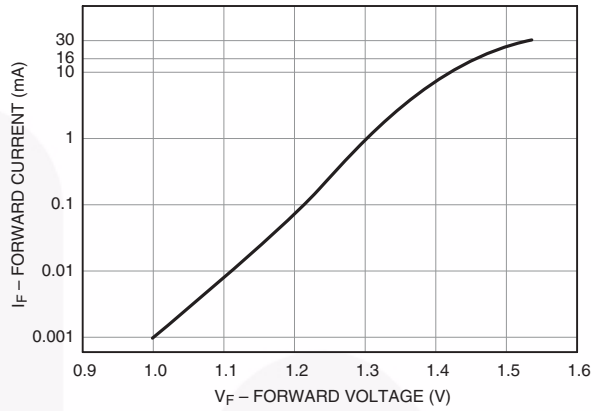

Fig.3 Switching Time vs. Forward Current

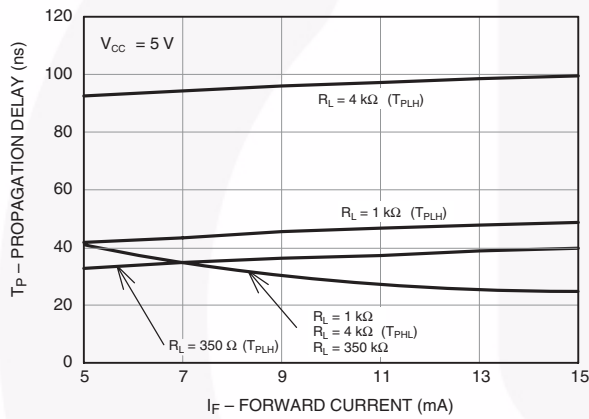

Fig. 4 Low Level Output Current vs. Ambient Temperature

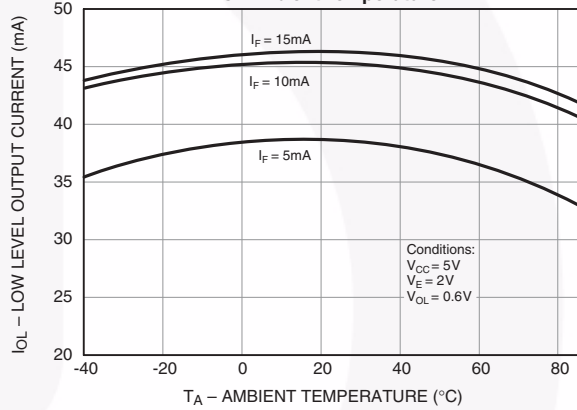

Fig. 5 Input Threshold Current vs. Ambient Temperature



Fig. 6 Output Voltage vs. Input Forward Current



Typical Performance Curves (Continued)

Fig. 7 Pulse Width Distortion vs. Temperature

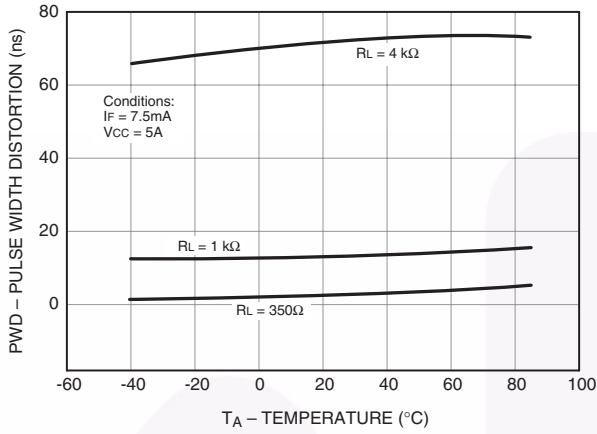

Fig. 8 Rise and Fall Time vs. Temperature



Fig. 9 Enable Propagation Delay vs. Temperature

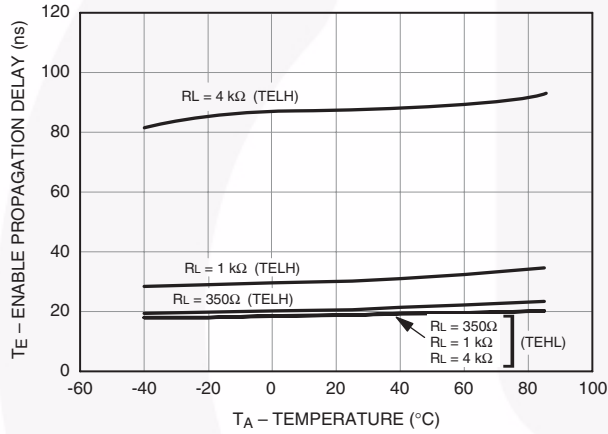
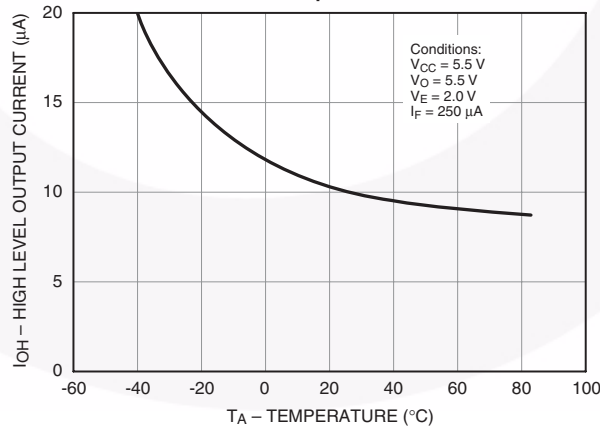

Fig. 10 Switching Time vs. Temperature



Fig. 11 High Level Output Current vs. Temperature



Test Circuits

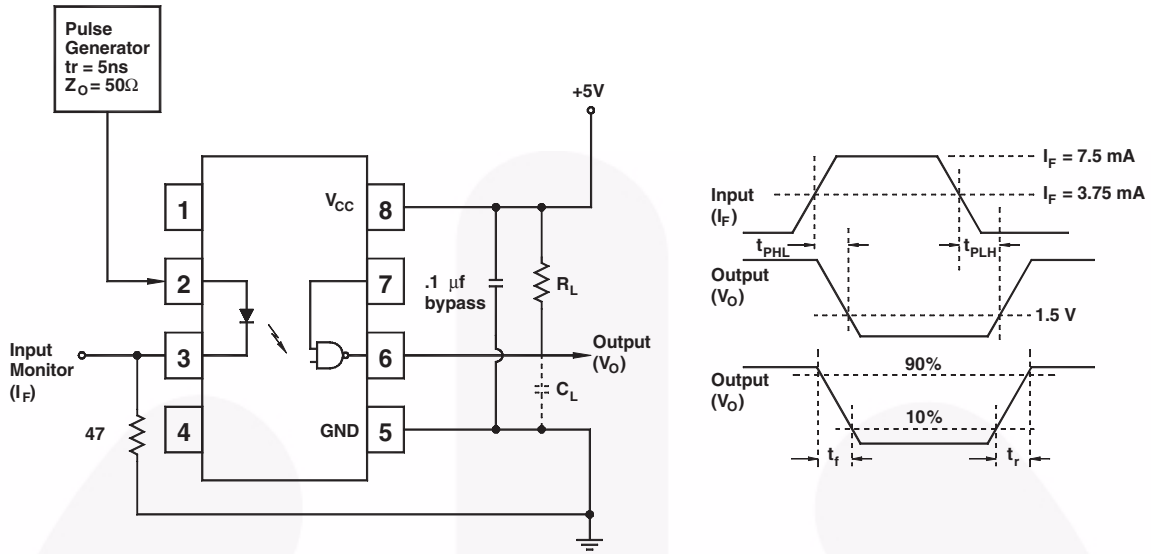

Fig. 12 Test Circuit and Waveforms for t_{PLH} , t_{PHL} , t_r and t_f



Fig. 13 Test Circuit t_{EHL} and t_{ELH}

Test Circuits (Continued)



Fig. 14 Test Circuit Common Mode Transient Immunity

Ordering Information

Option	Example Part Number	Description
S	6N137S	Surface Mount Lead Bend
SD	6N137SD	Surface Mount; Tape and Reel
W	6N137W	0.4" Lead Spacing
V	6N137V	VDE0884
WV	6N137WV	VDE0884; 0.4" Lead Spacing
SV	6N137SV	VDE0884; Surface Mount
SDV	6N137SDV	VDE0884; Surface Mount; Tape and Reel

Marking Information



Definitions	
1	Fairchild logo
2	Device number
3	VDE mark (Note: Only appears on parts ordered with VDE option – See order entry table)
4	Two digit year code, e.g., '03'
5	Two digit work week ranging from '01' to '53'
6	Assembly package code

Tape Specifications



Reflow Profile



- Peak reflow temperature: 225C (package surface temperature)
- Time of temperature higher than 183C for 60-150 seconds
- One time soldering reflow is recommended



- NOTES:
- A) NO STANDARD APPLIES TO THIS PACKAGE
 - B) ALL DIMENSIONS ARE IN MILLIMETERS.
 - C) DIMENSIONS ARE EXCLUSIVE OF BURRS, MOLD FLASH, AND TIE BAR EXTRUSION
 - D) DRAWING FILENAME AND REVISION: MKT-N08GREV7



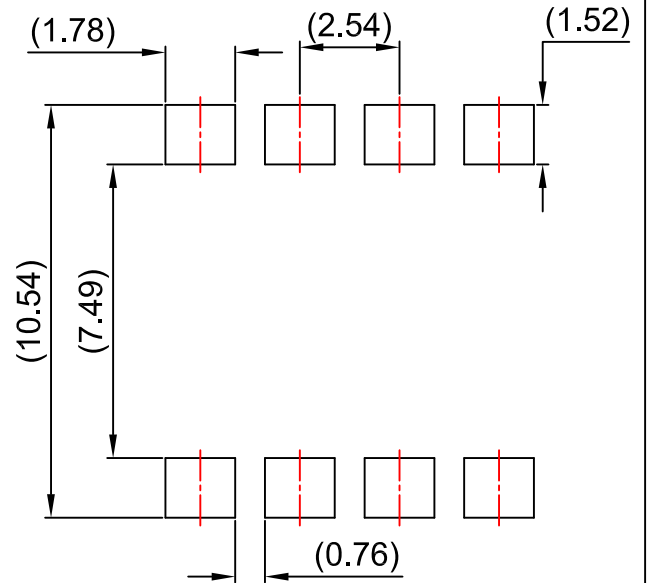
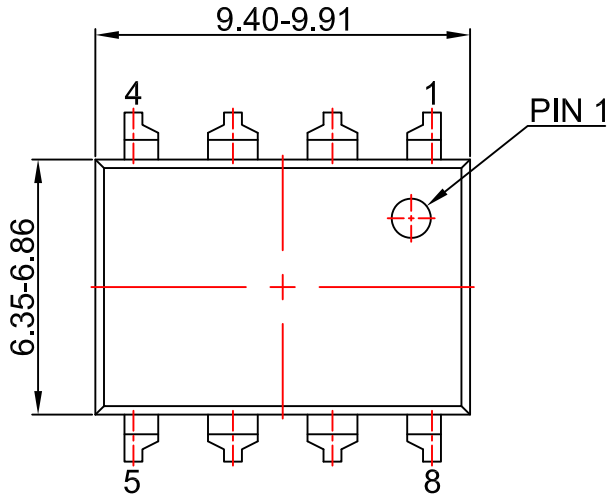

LAND PATTERN RECOMMENDATION

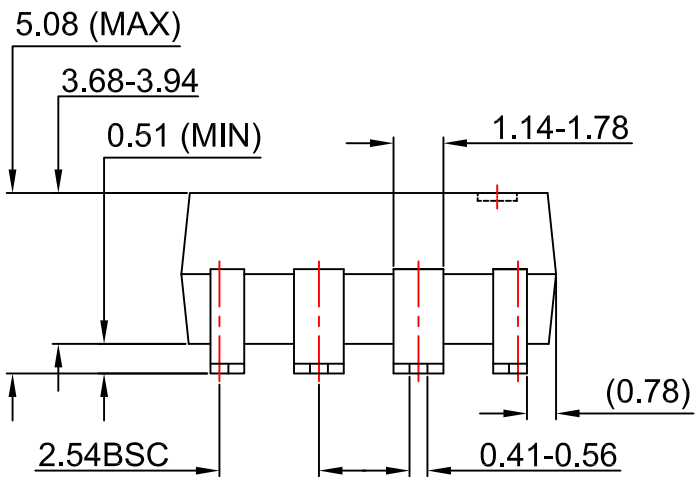

NOTES:

- A) NO STANDARD APPLIES TO THIS PACKAGE
- B) ALL DIMENSIONS ARE IN MILLIMETERS.
- C) DIMENSIONS ARE EXCLUSIVE OF BURRS, MOLD FLASH, AND TIE BAR EXTRUSION
- D) DRAWING FILENAME AND REVISION: MKT-N08Hrev7.





PIN 1

15.0° (MAX)

10.16 (TYP)

0.20-0.40



NOTES:

- A) NO STANDARD APPLIES TO THIS PACKAGE
- B) ALL DIMENSIONS ARE IN MILLIMETERS.
- C) DIMENSIONS ARE EXCLUSIVE OF BURRS, MOLD FLASH, AND TIE BAR EXTRUSION
- D) DRAWING FILENAME AND REVISION: MKT-N08REV7



ON Semiconductor and  are trademarks of Semiconductor Components Industries, LLC dba ON Semiconductor or its subsidiaries in the United States and/or other countries. ON Semiconductor owns the rights to a number of patents, trademarks, copyrights, trade secrets, and other intellectual property. A listing of ON Semiconductor's product/patent coverage may be accessed at www.onsemi.com/site/pdf/Patent-Marking.pdf. ON Semiconductor reserves the right to make changes without further notice to any products herein. ON Semiconductor makes no warranty, representation or guarantee regarding the suitability of its products for any particular purpose, nor does ON Semiconductor assume any liability arising out of the application or use of any product or circuit, and specifically disclaims any and all liability, including without limitation special, consequential or incidental damages. Buyer is responsible for its products and applications using ON Semiconductor products, including compliance with all laws, regulations and safety requirements or standards, regardless of any support or applications information provided by ON Semiconductor. "Typical" parameters which may be provided in ON Semiconductor data sheets and/or specifications can and do vary in different applications and actual performance may vary over time. All operating parameters, including "Typicals" must be validated for each customer application by customer's technical experts. ON Semiconductor does not convey any license under its patent rights nor the rights of others. ON Semiconductor products are not designed, intended, or authorized for use as a critical component in life support systems or any FDA Class 3 medical devices or medical devices with a same or similar classification in a foreign jurisdiction or any devices intended for implantation in the human body. Should Buyer purchase or use ON Semiconductor products for any such unintended or unauthorized application, Buyer shall indemnify and hold ON Semiconductor and its officers, employees, subsidiaries, affiliates, and distributors harmless against all claims, costs, damages, and expenses, and reasonable attorney fees arising out of, directly or indirectly, any claim of personal injury or death associated with such unintended or unauthorized use, even if such claim alleges that ON Semiconductor was negligent regarding the design or manufacture of the part. ON Semiconductor is an Equal Opportunity/Affirmative Action Employer. This literature is subject to all applicable copyright laws and is not for resale in any manner.

PUBLICATION ORDERING INFORMATION

LITERATURE FULFILLMENT:

Literature Distribution Center for ON Semiconductor
19521 E. 32nd Pkwy, Aurora, Colorado 80011 USA
Phone: 303-675-2175 or 800-344-3860 Toll Free USA/Canada
Fax: 303-675-2176 or 800-344-3867 Toll Free USA/Canada
Email: orderlit@onsemi.com

N. American Technical Support: 800-282-9855 Toll Free
USA/Canada
Europe, Middle East and Africa Technical Support:
Phone: 421 33 790 2910
Japan Customer Focus Center
Phone: 81-3-5817-1050

ON Semiconductor Website: www.onsemi.com
Order Literature: <http://www.onsemi.com/orderlit>
For additional information, please contact your local
Sales Representative

Mouser Electronics

Authorized Distributor

Click to View Pricing, Inventory, Delivery & Lifecycle Information:

[ON Semiconductor:](#)

[HCPL2630SD](#) [HCPL2630S](#) [HCPL2630SV](#) [HCPL2630](#) [HCPL2630WV](#) [HCPL2630SDV](#) [HCPL2630V](#)



Компания «ЭлектроПласт» предлагает заключение долгосрочных отношений при поставках импортных электронных компонентов на взаимовыгодных условиях!

Наши преимущества:

- Оперативные поставки широкого спектра электронных компонентов отечественного и импортного производства напрямую от производителей и с крупнейших мировых складов;
- Поставка более 17-ти миллионов наименований электронных компонентов;
- Поставка сложных, дефицитных, либо снятых с производства позиций;
- Оперативные сроки поставки под заказ (от 5 рабочих дней);
- Экспресс доставка в любую точку России;
- Техническая поддержка проекта, помощь в подборе аналогов, поставка прототипов;
- Система менеджмента качества сертифицирована по Международному стандарту ISO 9001;
- Лицензия ФСБ на осуществление работ с использованием сведений, составляющих государственную тайну;
- Поставка специализированных компонентов (Xilinx, Altera, Analog Devices, Intersil, Interpoint, Microsemi, Aeroflex, Peregrine, Syfer, Eurofarad, Texas Instrument, Miteq, Cobham, E2V, MA-COM, Hittite, Mini-Circuits, General Dynamics и др.);

Помимо этого, одним из направлений компании «ЭлектроПласт» является направление «Источники питания». Мы предлагаем Вам помощь Конструкторского отдела:

- Подбор оптимального решения, техническое обоснование при выборе компонента;
- Подбор аналогов;
- Консультации по применению компонента;
- Поставка образцов и прототипов;
- Техническая поддержка проекта;
- Защита от снятия компонента с производства.



Как с нами связаться

Телефон: 8 (812) 309 58 32 (многоканальный)

Факс: 8 (812) 320-02-42

Электронная почта: org@eplast1.ru

Адрес: 198099, г. Санкт-Петербург, ул. Калинина, дом 2, корпус 4, литера А.