

# MC14069UB

## Hex Inverter

The MC14069UB hex inverter is constructed with MOS P-channel and N-channel enhancement mode devices in a single monolithic structure. These inverters find primary use where low power dissipation and/or high noise immunity is desired. Each of the six inverters is a single stage to minimize propagation delays.

### Features

- Supply Voltage Range = 3.0 Vdc to 18 Vdc
- Capable of Driving Two Low-Power TTL Loads or One Low-Power Schottky TTL Load Over the Rated Temperature Range
- Triple Diode Protection on All Inputs
- Pin-for-Pin Replacement for CD4069UB
- Meets JEDEC UB Specifications
- These Devices are Pb-Free and are RoHS Compliant

### MAXIMUM RATINGS (Voltages Referenced to $V_{SS}$ )

| Symbol            | Parameter   | Value                  | Unit               |
|-------------------|---|------------------------|--------------------|
| $V_{DD}$          | DC Supply Voltage Range                           | -0.5 to +18.0          | V                  |
| $V_{in}, V_{out}$ | Input or Output Voltage Range (DC or Transient)   | -0.5 to $V_{DD} + 0.5$ | V                  |
| $I_{in}, I_{out}$ | Input or Output Current (DC or Transient) per Pin | $\pm 10$               | mA                 |
| $P_D$             | Power Dissipation, per Package (Note 1)           | 500                    | mW                 |
| $T_A$             | Ambient Temperature Range                         | -55 to +125            | $^{\circ}\text{C}$ |
| $T_{stg}$         | Storage Temperature Range                         | -65 to +150            | $^{\circ}\text{C}$ |
| $T_L$             | Lead Temperature (8-Second Soldering)             | 260                    | $^{\circ}\text{C}$ |

Stresses exceeding Maximum Ratings may damage the device. Maximum Ratings are stress ratings only. Functional operation above the Recommended Operating Conditions is not implied. Extended exposure to stresses above the Recommended Operating Conditions may affect device reliability.

1. Temperature Derating:  
Plastic "P and D/DW" Packages: - 7.0 mW/ $^{\circ}\text{C}$  From 65 $^{\circ}\text{C}$  To 125 $^{\circ}\text{C}$

This device contains protection circuitry to guard against damage due to high static voltages or electric fields. However, precautions must be taken to avoid applications of any voltage higher than maximum rated voltages to this high-impedance circuit. For proper operation,  $V_{in}$  and  $V_{out}$  should be constrained to the range  $V_{SS} \leq (V_{in} \text{ or } V_{out}) \leq V_{DD}$ .

Unused inputs must always be tied to an appropriate logic voltage level (e.g., either  $V_{SS}$  or  $V_{DD}$ ). Unused outputs must be left open.



ON Semiconductor®

<http://onsemi.com>

### MARKING DIAGRAMS

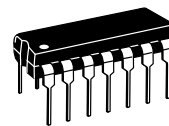

PDIP-14  
P SUFFIX  
CASE 646

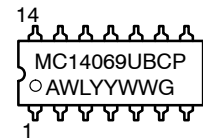

SOIC-14  
D SUFFIX  
CASE 751A

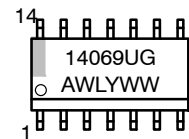

TSSOP-14  
DT SUFFIX  
CASE 948G

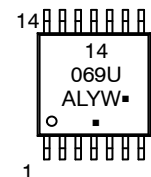

SOEIAJ-14  
F SUFFIX  
CASE 965

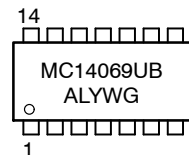

- A = Assembly Location
- WL, L = Wafer Lot
- YY, Y = Year
- WW, W = Work Week
- G or ■ = Pb-Free Package

(Note: Microdot may be in either location)

### ORDERING INFORMATION

See detailed ordering and shipping information in the package dimensions section on page 2 of this data sheet.

# MC14069UB

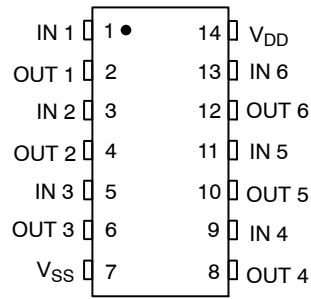

Figure 1. Pin Assignment

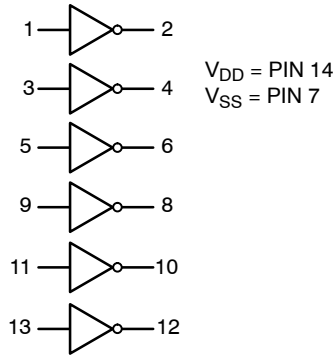
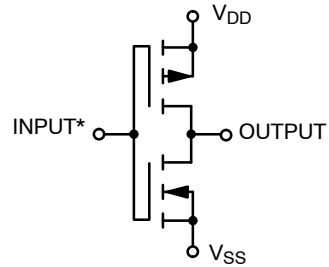

Figure 3. Logic Diagram



\*Double diode protection on all inputs not shown  
(1/6 of circuit shown)

Figure 2. Circuit Schematic

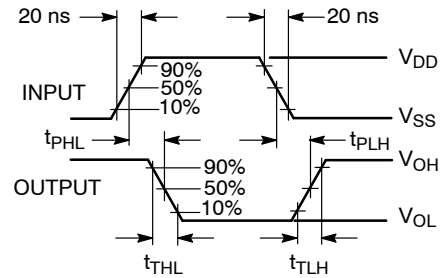
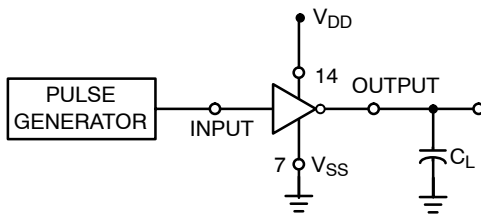

Figure 4. Switching Time Test Circuit and Waveforms

## ORDERING INFORMATION

| Device         | Package                | Shipping <sup>†</sup>             |
|----------------|------------------------|-----------------------------------|
| MC14069UBCPG   | PDIP-14<br>(Pb-Free)   | 500 Units / Tape & Ammunition Box |
| MC14069UBDG    | SOIC-14<br>(Pb-Free)   | 55 Units / Rail                   |
| MC14069UBDR2G  | SOIC-14<br>(Pb-Free)   | 2500 Units / Tape & Reel          |
| MC14069UBDTR2G | TSSOP-14*              | 2500 Units / Tape & Reel          |
| MC14069UBFELG  | SOEIAJ-14<br>(Pb-Free) | 2000 Units / Tape & Reel          |

<sup>†</sup>For information on tape and reel specifications, including part orientation and tape sizes, please refer to our Tape and Reel Packaging Specifications Brochure, BRD8011/D.

\*This package is inherently Pb-Free.

# MC14069UB

## ELECTRICAL CHARACTERISTICS (Voltages Referenced to V<sub>SS</sub>)

| Characteristic   | Symbol   | V <sub>DD</sub><br>Vdc | - 55°C   |       | 25°C  |                    |       | 125°C |       | Unit |
|--|--|------------------------|--|-------|-------|--------------------|-------|-------|-------|------|
|  |  |                        | Min  | Max   | Min   | Typ <sup>(2)</sup> | Max   | Min   | Max   |      |
| Output Voltage<br>V <sub>in</sub> = V <sub>DD</sub><br><br>V <sub>in</sub> = 0   | "0" Level<br>V <sub>OL</sub>                         | 5.0                    | -  | 0.05  | -     | 0                  | 0.05  | -     | 0.05  | Vdc  |
|  |  | 10                     | -  | 0.05  | -     | 0                  | 0.05  | -     | 0.05  |      |
|  |  | 15                     | -  | 0.05  | -     | 0                  | 0.05  | -     | 0.05  |      |
|  | "1" Level<br>V <sub>OH</sub>                         | 5.0                    | 4.95   | -     | 4.95  | 5.0                | -     | 4.95  | -     |      |
|  |  | 10                     | 9.95   | -     | 9.95  | 10                 | -     | 9.95  | -     |      |
|  |  | 15                     | 14.95  | -     | 14.95 | 15                 | -     | 14.95 | -     |      |
| Input Voltage<br>(V <sub>O</sub> = 4.5 Vdc)<br>(V <sub>O</sub> = 9.0 Vdc)<br>(V <sub>O</sub> = 13.5 Vdc)<br><br>(V <sub>O</sub> = 0.5 Vdc)<br>(V <sub>O</sub> = 1.0 Vdc)<br>(V <sub>O</sub> = 1.5 Vdc)   | "0" Level<br>V <sub>IL</sub>                         | 5.0                    | -  | 1.0   | -     | 2.25               | 1.0   | -     | 1.0   | Vdc  |
|  |  | 10                     | -  | 2.0   | -     | 4.50               | 2.0   | -     | 2.0   |      |
|  |  | 15                     | -  | 2.5   | -     | 6.75               | 2.5   | -     | 2.5   |      |
|  | "1" Level<br>V <sub>IH</sub>                         | 5.0                    | 4.0  | -     | 4.0   | 2.75               | -     | 4.0   | -     |      |
|  |  | 10                     | 8.0  | -     | 8.0   | 5.50               | -     | 8.0   | -     |      |
|  |  | 15                     | 12.5   | -     | 12.5  | 8.25               | -     | 12.5  | -     |      |
| Output Drive Current<br>(V <sub>OH</sub> = 2.5 Vdc)<br>(V <sub>OH</sub> = 4.6 Vdc)<br>(V <sub>OH</sub> = 9.5 Vdc)<br>(V <sub>OH</sub> = 13.5 Vdc)<br><br>(V <sub>OL</sub> = 0.4 Vdc)<br>(V <sub>OL</sub> = 0.5 Vdc)<br>(V <sub>OL</sub> = 1.5 Vdc)   | Source<br>I <sub>OH</sub>                            | 5.0                    | -3.0   | -     | -2.4  | -4.2               | -     | -1.7  | -     | mAdc |
|  |  | 5.0                    | -0.64  | -     | -0.51 | -0.88              | -     | -0.36 | -     |      |
|  |  | 10                     | -1.6   | -     | -1.3  | -2.25              | -     | -0.9  | -     |      |
|  |  | 15                     | -4.2   | -     | -3.4  | -8.8               | -     | -2.4  | -     |      |
|  | Sink<br>I <sub>OL</sub>                              | 5.0                    | 0.64   | -     | 0.51  | 0.88               | -     | 0.36  | -     | mAdc |
|  |  | 10                     | 1.6  | -     | 1.3   | 2.25               | -     | 0.9   | -     |      |
| 15   |  | 4.2                    | -  | 3.4   | 8.8   | -                  | 2.4   | -     |       |      |
| Input Current  | I <sub>in</sub>                                      | 15                     | -  | ± 0.1 | -     | ± 0.00001          | ± 0.1 | -     | ± 1.0 | μAdc |
| Input Capacitance<br>(V <sub>in</sub> = 0)   | C <sub>in</sub>                                      | -                      | -  | -     | -     | 5.0                | 7.5   | -     | -     | pF   |
| Quiescent Current<br>(Per Package)   | I <sub>DD</sub>                                      | 5.0                    | -  | 0.25  | -     | 0.0005             | 0.25  | -     | 7.5   | μAdc |
|  |  | 10                     | -  | 0.5   | -     | 0.0010             | 0.5   | -     | 15    |      |
|  |  | 15                     | -  | 1.0   | -     | 0.0015             | 1.0   | -     | 30    |      |
| Total Supply Current <sup>(3) (4)</sup><br>(Dynamic plus Quiescent,<br>Per Gate) (C <sub>L</sub> = 50 pF)  | I <sub>T</sub>                                       | 5.0                    | I <sub>T</sub> = (0.3 μA/kHz) f + I <sub>DD</sub> /6 |       |       |                    |       |       |       | μAdc |
| 10   | I <sub>T</sub> = (0.6 μA/kHz) f + I <sub>DD</sub> /6 |                        |  |       |       |                    |       |       |       |      |
| 15   | I <sub>T</sub> = (0.9 μA/kHz) f + I <sub>DD</sub> /6 |                        |  |       |       |                    |       |       |       |      |
| Output Rise and Fall Times <sup>(3)</sup><br>(C <sub>L</sub> = 50 pF)<br>t <sub>TLH</sub> , t <sub>THL</sub> = (1.35 ns/pF) C <sub>L</sub> + 33 ns<br>t <sub>TLH</sub> , t <sub>THL</sub> = (0.60 ns/pF) C <sub>L</sub> + 20 ns<br>t <sub>TLH</sub> , t <sub>THL</sub> = (0.40 ns/pF) C <sub>L</sub> + 20 ns | t <sub>TLH</sub> ,<br>t <sub>THL</sub>               | 5.0                    | -  | -     | -     | 100                | 200   | -     | -     | ns   |
|  |  | 10                     | -  | -     | -     | 50                 | 100   | -     | -     |      |
|  |  | 15                     | -  | -     | -     | 40                 | 80    | -     | -     |      |
|  |  | 15                     | -  | -     | -     | 40                 | 80    | -     | -     |      |
| Propagation Delay Times <sup>(3)</sup><br>(C <sub>L</sub> = 50 pF)<br>t <sub>PLH</sub> , t <sub>PHL</sub> = (0.90 ns/pF) C <sub>L</sub> + 20 ns<br>t <sub>PLH</sub> , t <sub>PHL</sub> = (0.36 ns/pF) C <sub>L</sub> + 22 ns<br>t <sub>PLH</sub> , t <sub>PHL</sub> = (0.26 ns/pF) C <sub>L</sub> + 17 ns    | t <sub>PLH</sub> ,<br>t <sub>PHL</sub>               | 5.0                    | -  | -     | -     | 65                 | 125   | -     | -     | ns   |
|  |  | 10                     | -  | -     | -     | 40                 | 75    | -     | -     |      |
|  |  | 15                     | -  | -     | -     | 30                 | 55    | -     | -     |      |
|  |  | 15                     | -  | -     | -     | 30                 | 55    | -     | -     |      |

2. Data labelled "Typ" is not to be used for design purposes but is intended as an indication of the IC's potential performance.

3. The formulas given are for the typical characteristics only at 25°C.

4. To calculate total supply current at loads other than 50 pF:

$$I_T(C_L) = I_T(50 \text{ pF}) + (C_L - 50) Vfk$$

where: I<sub>T</sub> is in μA (per package), C<sub>L</sub> in pF, V = (V<sub>DD</sub> - V<sub>SS</sub>) in volts, f in kHz is input frequency, and k = 0.002.

# MC14069UB

## PACKAGE DIMENSIONS

**PDIP-14**  
CASE 646-06  
ISSUE P

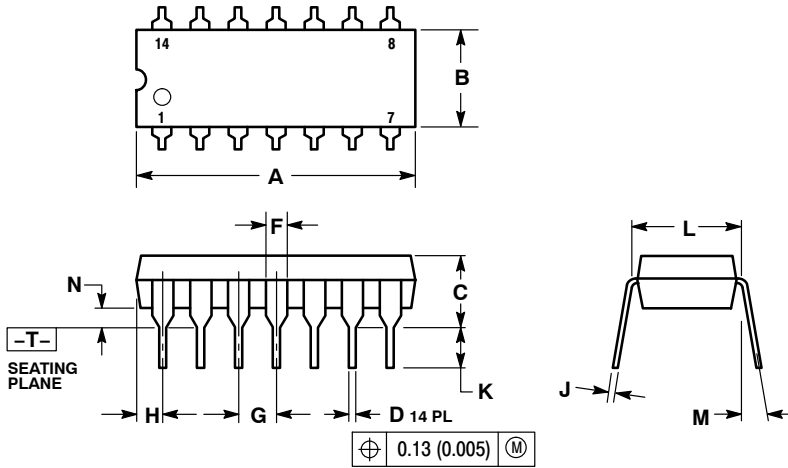

**NOTES:**

1. DIMENSIONING AND TOLERANCING PER ANSI Y14.5M, 1982.
2. CONTROLLING DIMENSION: INCH.
3. DIMENSION L TO CENTER OF LEADS WHEN FORMED PARALLEL.
4. DIMENSION B DOES NOT INCLUDE MOLD FLASH.
5. ROUNDED CORNERS OPTIONAL.

| DIM | INCHES    |       | MILLIMETERS |       |
|-----|-----------|-------|-------------|-------|
|     | MIN       | MAX   | MIN         | MAX   |
| A   | 0.715     | 0.770 | 18.16       | 19.56 |
| B   | 0.240     | 0.260 | 6.10        | 6.60  |
| C   | 0.145     | 0.185 | 3.69        | 4.69  |
| D   | 0.015     | 0.021 | 0.38        | 0.53  |
| F   | 0.040     | 0.070 | 1.02        | 1.78  |
| G   | 0.100 BSC |       | 2.54 BSC    |       |
| H   | 0.052     | 0.095 | 1.32        | 2.41  |
| J   | 0.008     | 0.015 | 0.20        | 0.38  |
| K   | 0.115     | 0.135 | 2.92        | 3.43  |
| L   | 0.290     | 0.310 | 7.37        | 7.87  |
| M   | ---       | 10°   | ---         | 10°   |
| N   | 0.015     | 0.039 | 0.38        | 1.01  |

# MC14069UB

## PACKAGE DIMENSIONS

SOIC-14 NB  
CASE 751A-03  
ISSUE K

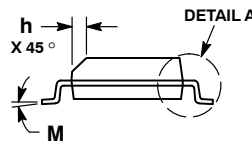
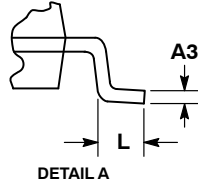
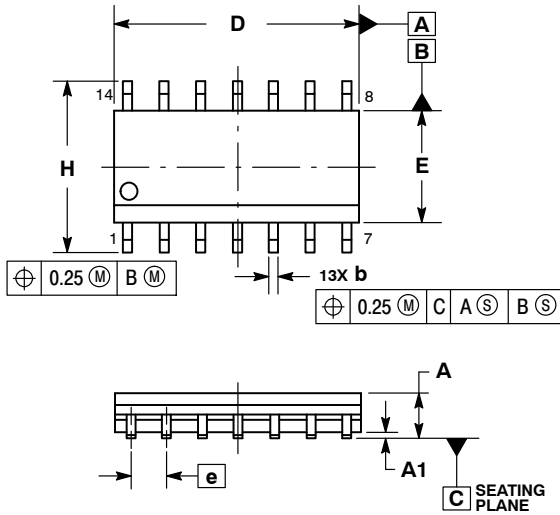

NOTES:

1. DIMENSIONING AND TOLERANCING PER ASME Y14.5M, 1994.
2. CONTROLLING DIMENSION: MILLIMETERS.
3. DIMENSION b DOES NOT INCLUDE DAMBAR PROTRUSION. ALLOWABLE PROTRUSION SHALL BE 0.13 TOTAL IN EXCESS OF AT MAXIMUM MATERIAL CONDITION.
4. DIMENSIONS D AND E DO NOT INCLUDE MOLD PROTRUSIONS.
5. MAXIMUM MOLD PROTRUSION 0.15 PER SIDE.

| DIM | MILLIMETERS |      | INCHES    |       |
|-----|-------------|------|-----------|-------|
|     | MIN         | MAX  | MIN       | MAX   |
| A   | 1.35        | 1.75 | 0.054     | 0.068 |
| A1  | 0.10        | 0.25 | 0.004     | 0.010 |
| A3  | 0.19        | 0.25 | 0.008     | 0.010 |
| b   | 0.35        | 0.49 | 0.014     | 0.019 |
| D   | 8.55        | 8.75 | 0.337     | 0.344 |
| E   | 3.80        | 4.00 | 0.150     | 0.157 |
| e   | 1.27 BSC    |      | 0.050 BSC |       |
| H   | 5.80        | 6.20 | 0.228     | 0.244 |
| h   | 0.25        | 0.50 | 0.010     | 0.019 |
| L   | 0.40        | 1.25 | 0.016     | 0.049 |
| M   | 0°          | 7°   | 0°        | 7°    |

### SOLDERING FOOTPRINT\*

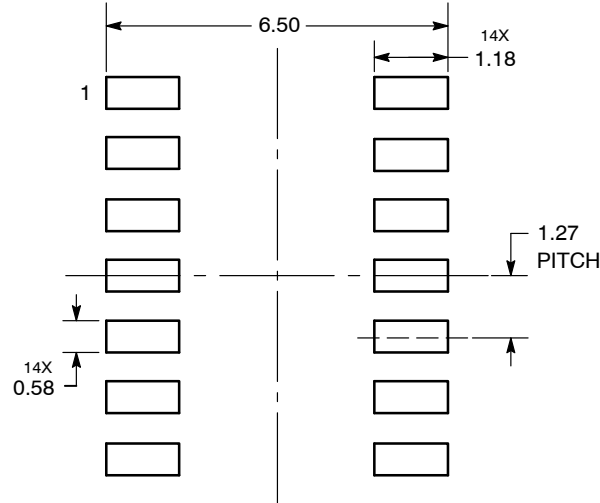

DIMENSIONS: MILLIMETERS

\*For additional information on our Pb-Free strategy and soldering details, please download the ON Semiconductor Soldering and Mounting Techniques Reference Manual, SOLDERRM/D.

# MC14069UB

## PACKAGE DIMENSIONS

TSSOP-14  
CASE 948G-01  
ISSUE B

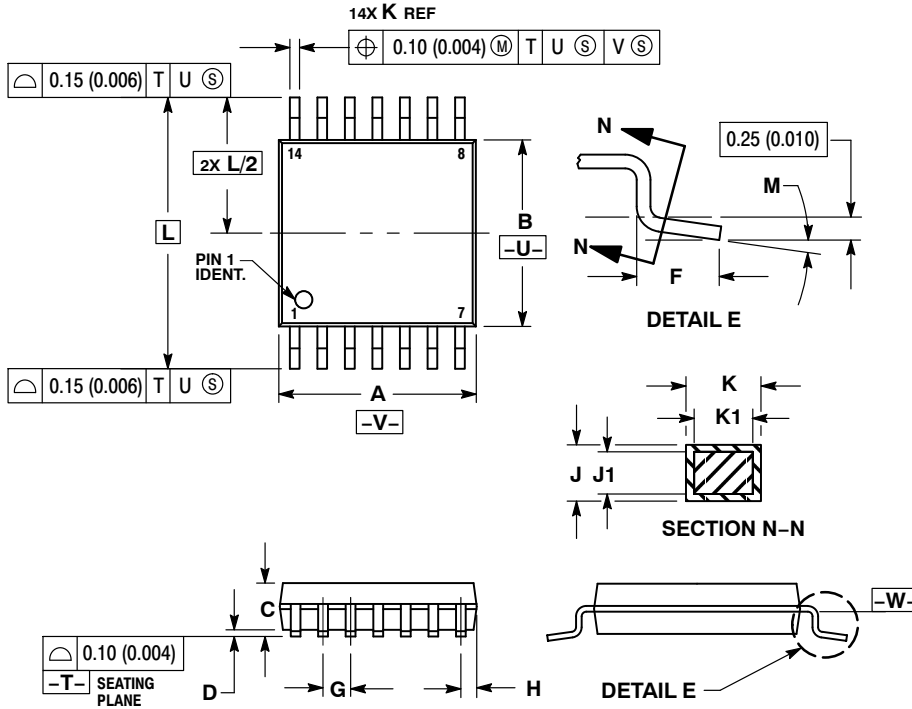

- NOTES:
1. DIMENSIONING AND TOLERANCING PER ANSI Y14.5M, 1982.
  2. CONTROLLING DIMENSION: MILLIMETER.
  3. DIMENSION A DOES NOT INCLUDE MOLD FLASH, PROTRUSIONS OR GATE BURRS. MOLD FLASH OR GATE BURRS SHALL NOT EXCEED 0.15 (0.006) PER SIDE.
  4. DIMENSION B DOES NOT INCLUDE INTERLEAD FLASH OR PROTRUSION. INTERLEAD FLASH OR PROTRUSION SHALL NOT EXCEED 0.25 (0.010) PER SIDE.
  5. DIMENSION K DOES NOT INCLUDE DAMBAR PROTRUSION. ALLOWABLE DAMBAR PROTRUSION SHALL BE 0.08 (0.003) TOTAL IN EXCESS OF THE K DIMENSION AT MAXIMUM MATERIAL CONDITION.
  6. TERMINAL NUMBERS ARE SHOWN FOR REFERENCE ONLY.
  7. DIMENSION A AND B ARE TO BE DETERMINED AT DATUM PLANE -W-.

| DIM | MILLIMETERS |      | INCHES    |       |
|-----|-------------|------|-----------|-------|
|     | MIN         | MAX  | MIN       | MAX   |
| A   | 4.90        | 5.10 | 0.193     | 0.200 |
| B   | 4.30        | 4.50 | 0.169     | 0.177 |
| C   | ---         | 1.20 | ---       | 0.047 |
| D   | 0.05        | 0.15 | 0.002     | 0.006 |
| F   | 0.50        | 0.75 | 0.020     | 0.030 |
| G   | 0.65 BSC    |      | 0.026 BSC |       |
| H   | 0.50        | 0.60 | 0.020     | 0.024 |
| J   | 0.09        | 0.20 | 0.004     | 0.008 |
| J1  | 0.09        | 0.16 | 0.004     | 0.006 |
| K   | 0.19        | 0.30 | 0.007     | 0.012 |
| K1  | 0.19        | 0.25 | 0.007     | 0.010 |
| L   | 6.40 BSC    |      | 0.252 BSC |       |
| M   | 0°          | 8°   | 0°        | 8°    |

### SOLDERING FOOTPRINT\*

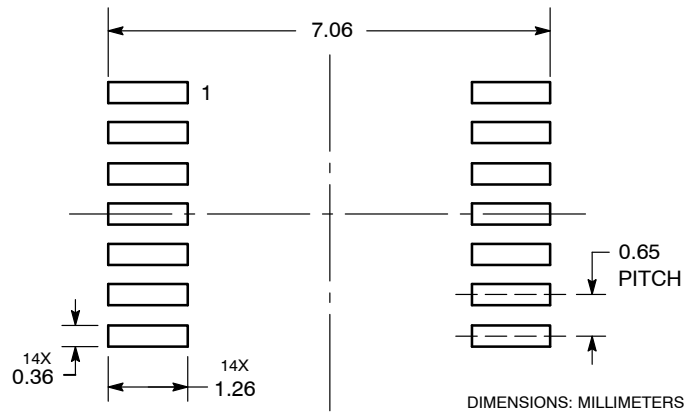

\*For additional information on our Pb-Free strategy and soldering details, please download the ON Semiconductor Soldering and Mounting Techniques Reference Manual, SOLDERRM/D.

# MC14069UB

## PACKAGE DIMENSIONS

SOEIAJ-14  
CASE 965-01  
ISSUE B

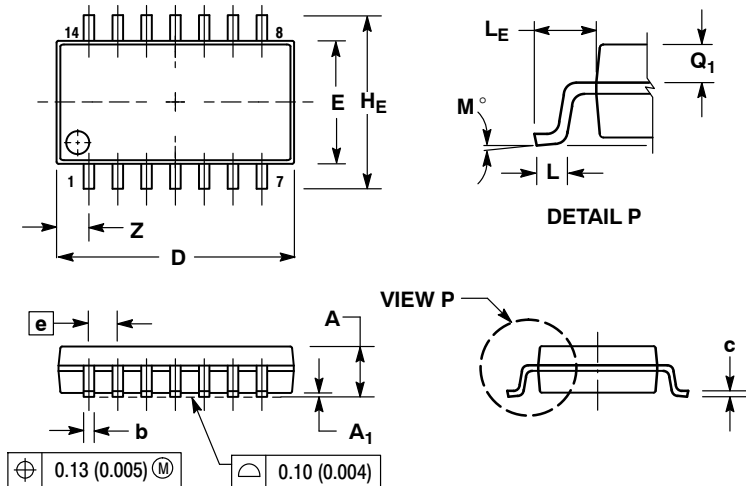

### NOTES:

1. DIMENSIONING AND TOLERANCING PER ANSI Y14.5M, 1982.
2. CONTROLLING DIMENSION: MILLIMETER.
3. DIMENSIONS D AND E DO NOT INCLUDE MOLD FLASH OR PROTRUSIONS AND ARE MEASURED AT THE PARTING LINE. MOLD FLASH OR PROTRUSIONS SHALL NOT EXCEED 0.15 (0.006) PER SIDE.
4. TERMINAL NUMBERS ARE SHOWN FOR REFERENCE ONLY.
5. THE LEAD WIDTH DIMENSION (b) DOES NOT INCLUDE DAMBAR PROTRUSION. ALLOWABLE DAMBAR PROTRUSION SHALL BE 0.08 (0.003) TOTAL IN EXCESS OF THE LEAD WIDTH DIMENSION AT MAXIMUM MATERIAL CONDITION. DAMBAR CANNOT BE LOCATED ON THE LOWER RADIUS OR THE FOOT. MINIMUM SPACE BETWEEN PROTRUSIONS AND ADJACENT LEAD TO BE 0.46 (0.018).

| DIM            | MILLIMETERS |       | INCHES    |       |
|----------------|-------------|-------|-----------|-------|
|                | MIN         | MAX   | MIN       | MAX   |
| A              | ---         | 2.05  | ---       | 0.081 |
| A <sub>1</sub> | 0.05        | 0.20  | 0.002     | 0.008 |
| b              | 0.35        | 0.50  | 0.014     | 0.020 |
| c              | 0.10        | 0.20  | 0.004     | 0.008 |
| D              | 9.90        | 10.50 | 0.390     | 0.413 |
| E              | 5.10        | 5.45  | 0.201     | 0.215 |
| e              | 1.27 BSC    |       | 0.050 BSC |       |
| HE             | 7.40        | 8.20  | 0.291     | 0.323 |
| L              | 0.50        | 0.85  | 0.020     | 0.033 |
| LE             | 1.10        | 1.50  | 0.043     | 0.059 |
| M              | 0°          | 10°   | 0°        | 10°   |
| Q <sub>1</sub> | 0.70        | 0.90  | 0.028     | 0.035 |
| Z              | ---         | 1.42  | ---       | 0.056 |

ON Semiconductor and are registered trademarks of Semiconductor Components Industries, LLC (SCILLC). SCILLC reserves the right to make changes without further notice to any products herein. SCILLC makes no warranty, representation or guarantee regarding the suitability of its products for any particular purpose, nor does SCILLC assume any liability arising out of the application or use of any product or circuit, and specifically disclaims any and all liability, including without limitation special, consequential or incidental damages. "Typical" parameters which may be provided in SCILLC data sheets and/or specifications can and do vary in different applications and actual performance may vary over time. All operating parameters, including "Typicals" must be validated for each customer application by customer's technical experts. SCILLC does not convey any license under its patent rights nor the rights of others. SCILLC products are not designed, intended, or authorized for use as components in systems intended for surgical implant into the body, or other applications intended to support or sustain life, or for any other application in which the failure of the SCILLC product could create a situation where personal injury or death may occur. Should Buyer purchase or use SCILLC products for any such unintended or unauthorized application, Buyer shall indemnify and hold SCILLC and its officers, employees, subsidiaries, affiliates, and distributors harmless against all claims, costs, damages, and expenses, and reasonable attorney fees arising out of, directly or indirectly, any claim of personal injury or death associated with such unintended or unauthorized use, even if such claim alleges that SCILLC was negligent regarding the design or manufacture of the part. SCILLC is an Equal Opportunity/Affirmative Action Employer. This literature is subject to all applicable copyright laws and is not for resale in any manner.

### PUBLICATION ORDERING INFORMATION

**LITERATURE FULFILLMENT:**  
Literature Distribution Center for ON Semiconductor  
P.O. Box 5163, Denver, Colorado 80217 USA  
**Phone:** 303-675-2175 or 800-344-3860 Toll Free USA/Canada  
**Fax:** 303-675-2176 or 800-344-3867 Toll Free USA/Canada  
**Email:** orderlit@onsemi.com

**N. American Technical Support:** 800-282-9855 Toll Free  
USA/Canada  
**Europe, Middle East and Africa Technical Support:**  
Phone: 421 33 790 2910  
**Japan Customer Focus Center**  
Phone: 81-3-5773-3850

**ON Semiconductor Website:** [www.onsemi.com](http://www.onsemi.com)  
**Order Literature:** <http://www.onsemi.com/orderlit>  
For additional information, please contact your local Sales Representative



Компания «ЭлектроПласт» предлагает заключение долгосрочных отношений при поставках импортных электронных компонентов на взаимовыгодных условиях!

Наши преимущества:

- Оперативные поставки широкого спектра электронных компонентов отечественного и импортного производства напрямую от производителей и с крупнейших мировых складов;
- Поставка более 17-ти миллионов наименований электронных компонентов;
- Поставка сложных, дефицитных, либо снятых с производства позиций;
- Оперативные сроки поставки под заказ (от 5 рабочих дней);
- Экспресс доставка в любую точку России;
- Техническая поддержка проекта, помощь в подборе аналогов, поставка прототипов;
- Система менеджмента качества сертифицирована по Международному стандарту ISO 9001;
- Лицензия ФСБ на осуществление работ с использованием сведений, составляющих государственную тайну;
- Поставка специализированных компонентов (Xilinx, Altera, Analog Devices, Intersil, Interpoint, Microsemi, Aeroflex, Peregrine, Syfer, Eurofarad, Texas Instrument, Miteq, Cobham, E2V, MA-COM, Hittite, Mini-Circuits, General Dynamics и др.);

Помимо этого, одним из направлений компании «ЭлектроПласт» является направление «Источники питания». Мы предлагаем Вам помощь Конструкторского отдела:

- Подбор оптимального решения, техническое обоснование при выборе компонента;
- Подбор аналогов;
- Консультации по применению компонента;
- Поставка образцов и прототипов;
- Техническая поддержка проекта;
- Защита от снятия компонента с производства.



#### Как с нами связаться

**Телефон:** 8 (812) 309 58 32 (многоканальный)

**Факс:** 8 (812) 320-02-42

**Электронная почта:** [org@eplast1.ru](mailto:org@eplast1.ru)

**Адрес:** 198099, г. Санкт-Петербург, ул. Калинина, дом 2, корпус 4, литера А.