

## 6A, 200V - 600V Surface Mount Ultrafast Rectifiers

### FEATURES

- Very low profile, typical height of 1.1mm
- Excellent high temperature stability
- Glass passivated chip junction
- Controlled avalanche characteristics
- Low leakage current
- High forward surge capability
- Compliant to RoHS Directive 2011/65/EU and in accordance to WEEE 2002/96/EC
- Halogen-free according to IEC 61249-2-21

### TYPICAL APPLICATIONS

For use in high voltage, high frequency power factor corrections, switching mode power supplies, freewheeling diodes and secondary dc to dc rectifications

### MECHANICAL DATA

**Case:** TO-277A (SMPC)

Molding compound, UL flammability classification rating 94V-0

Moisture sensitivity level: level 1, per J-STD-020

Part no. with suffix "H" means AEC-Q101 qualified

Packing code suffix "G" means green compound (halogen-free)

**Terminal:** Matte tin plated leads, solderable per JESD22-B102

Meet JESD 201 class 1A whisker test

**Polarity:** Indicated by cathode band

**Weight:** 95 mg (approximately)

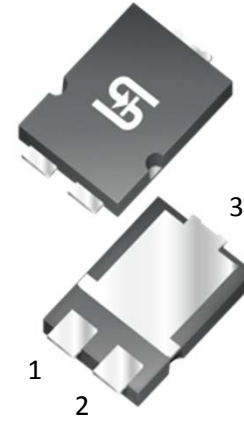

**TO-277A (SMPC)**



MAXIMUM RATINGS AND ELECTRICAL CHARACTERISTICS (T <sub>A</sub> =25°C unless otherwise noted)						
PARAMETER	SYMBOL	TPUH6D	TPUH6J	UNIT		
Marking code		UH6D	UH6J			
Maximum repetitive peak reverse voltage	V <sub>RRM</sub>	200	600	V		
Maximum average forward rectified current	I <sub>F(AV)</sub>	6		A		
Peak forward surge current, 8.3 ms single half sine-wave superimposed on rated load	I <sub>FSM</sub>	80		A		
Maximum instantaneous forward voltage <sup>(1)</sup>	I <sub>F</sub> =3A	Test condition		V		
		T <sub>J</sub> =25°C	TYP		MAX	TYP
	T <sub>J</sub> =125°C	0.80	-		1.98	-
	I <sub>F</sub> =6A	T <sub>J</sub> =25°C	0.65		-	1.23
		T <sub>J</sub> =125°C	0.87	1.05	2.45	3.00
			0.73	0.90	1.59	1.80
Maximum reverse current @ rated V <sub>R</sub>		T <sub>J</sub> =25°C	10		μA	
		T <sub>J</sub> =125°C	200			
Maximum reverse recovery time	I <sub>F</sub> =0.5A, I <sub>R</sub> =1A, I <sub>RR</sub> =0.25A		25		ns	
			I <sub>F</sub> =1A, di/dt=-50A/μs, V <sub>R</sub> =30V	45		
Typical thermal resistance		R <sub>θJM</sub> <sup>(2)</sup>	12		°C/W	
		R <sub>θJA</sub> <sup>(3)</sup>	80			
Typical junction capacitance <sup>(4)</sup>		C <sub>J</sub>	50		pF	
Operating junction temperature range		T <sub>J</sub>	- 55 to +175		°C	
Storage temperature range		T <sub>STG</sub>	- 55 to +175		°C	

Note 1: Pulse test with PW=300μs, 1% duty cycle

Note 2: Mounted on FR4 PCB with 16mm x 16mm Cu pad area

Note 3: Free air, mounted on recommended pad

Note 4: Measured at 1 MHz and Applied V<sub>R</sub>=4.0 V

ORDERING INFORMATION					
PART NO.	PART NO. SUFFIX	PACKING CODE	PACKING CODE SUFFIX	PACKAGE	PACKING
TPUH6x (Note 1, 2)	H	S1	G	SMPC	1,500/ 7" Plastic reel
		S2		SMPC	6,000/ 13" Plastic reel

Note 1: "x" defines voltage from 200V (TPUH6D) to 600V (TPUH6J)

Note 2: Whole series with green compound

EXAMPLE					
PREFERRED PART NO.	PART NO.	PART NO. SUFFIX	PACKING CODE	PACKING CODE SUFFIX	DESCRIPTION
TPUH6JHS1G	TPUH6J	H	S1	G	AEC-Q101 qualified Green compound

**RATINGS AND CHARACTERISTICS CURVES**

( $T_A=25^\circ\text{C}$  unless otherwise noted)

FIG. 1 MAXIMUM FORWARD CURRENT DERATING CURVE

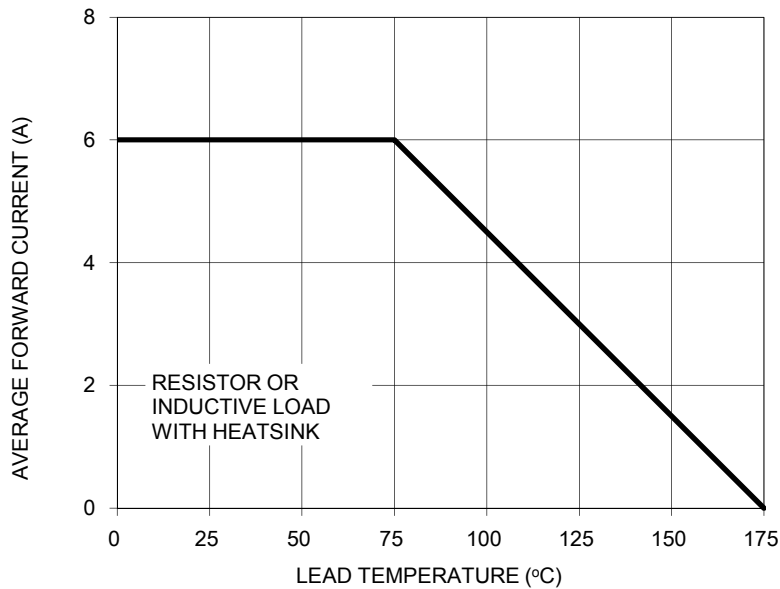

FIG. 2 TYPICAL INSTANTANEOUS FORWARD CHARACTERISTICS

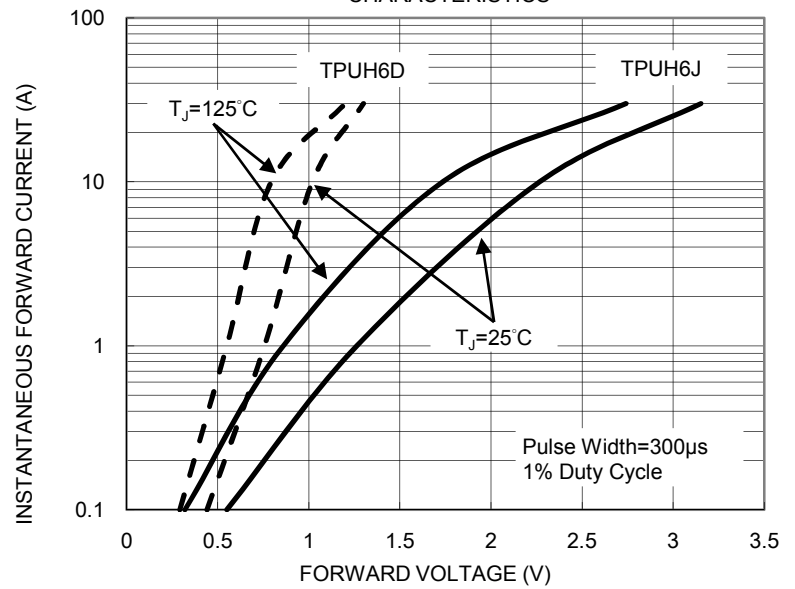

FIG. 3 MAXIMUM NON-REPETITIVE FORWARD PEAK SURGE CURRENT

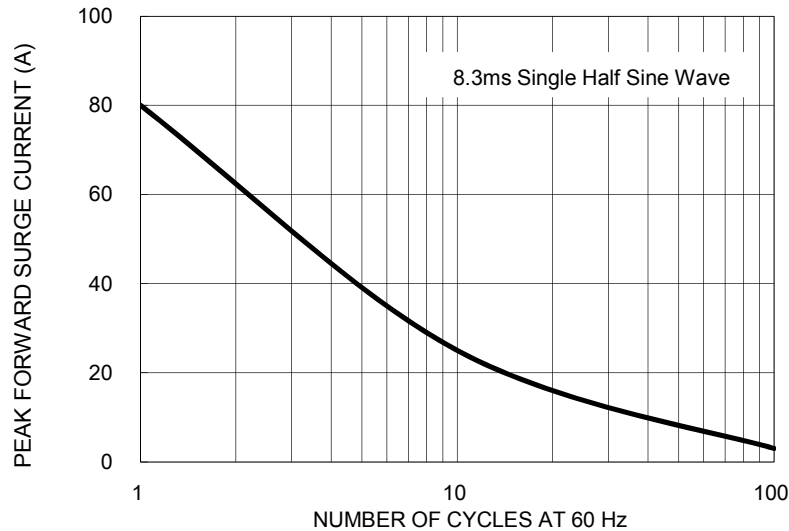

FIG. 4 TYPICAL REVERSE CHARACTERISTICS

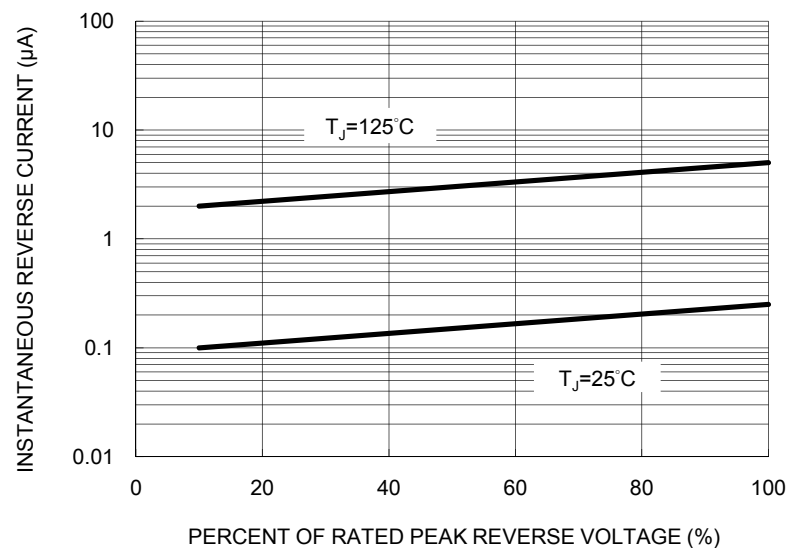

FIG. 5 TYPICAL JUNCTION CAPACITANCE

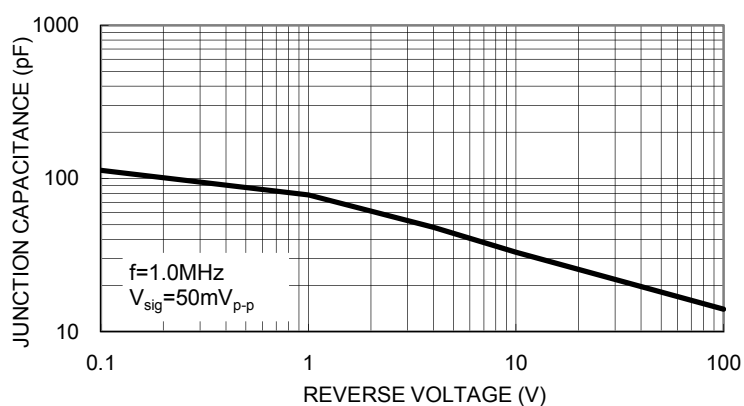
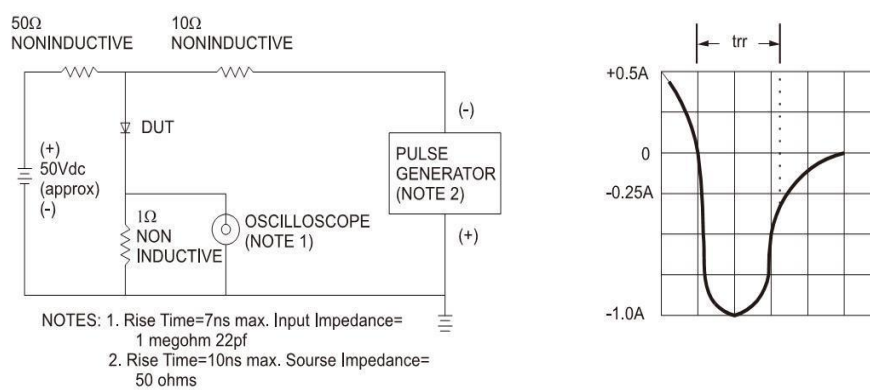
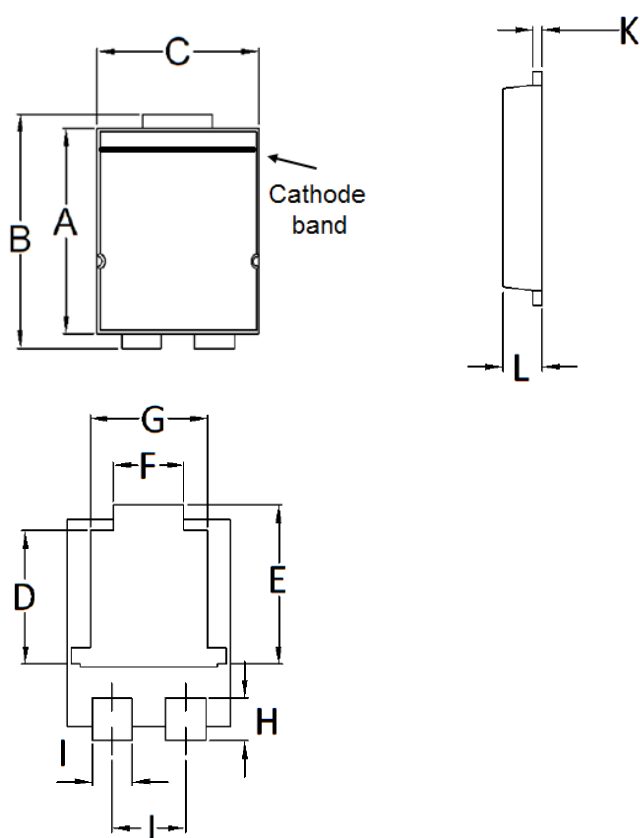

FIG.6 REVERSE RECOVERY TIME CHARACTERISTIC AND TEST CIRCUIT DIAGRAM



PACKAGE OUTLINE DIMENSIONS  
**TO-277A (SMPC)**



DIM.	Unit (mm)		Unit (inch)	
	Min	Max	Min	Max
A	5.650	5.750	0.222	0.226
B	6.350	6.650	0.250	0.262
C	4.550	4.650	0.179	0.183
D	3.540	3.840	0.139	0.151
E	4.235	4.535	0.167	0.179
F	1.850	2.150	0.073	0.085
G	3.170	3.470	0.125	0.137
H	1.043	1.343	0.041	0.053
I	1.000	1.300	0.039	0.051
J	1.930	2.230	0.076	0.088
K	0.175	0.325	0.007	0.013
L	1.000	1.200	0.039	0.047

SUGGESTED PAD LAYOUT

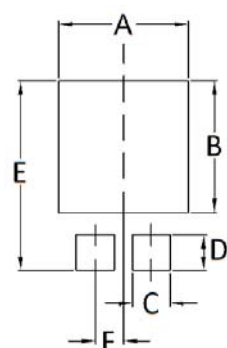

Symbol	Unit (mm)	Unit (inch)
A	4.80	0.189
B	4.72	0.186
C	1.40	0.055
D	1.27	0.050
E	6.80	0.268
F	1.04	0.041

MARKING DIAGRAM



P/N = Marking Code  
YW = Date Code  
F = Factory Code

## Notice

Specifications of the products displayed herein are subject to change without notice. TSC or anyone on its behalf, assumes no responsibility or liability for any errors or inaccuracies.

Information contained herein is intended to provide a product description only. No license, express or implied, to any intellectual property rights is granted by this document. Except as provided in TSC's terms and conditions of sale for such products, TSC assumes no liability whatsoever, and disclaims any express or implied warranty, relating to sale and/or use of TSC products including liability or warranties relating to fitness for a particular purpose, merchantability, or infringement of any patent, copyright, or other intellectual property right.

The products shown herein are not designed for use in medical, life-saving, or life-sustaining applications. Customers using or selling these products for use in such applications do so at their own risk and agree to fully indemnify TSC for any damages resulting from such improper use or sale.



Компания «ЭлектроПласт» предлагает заключение долгосрочных отношений при поставках импортных электронных компонентов на взаимовыгодных условиях!

Наши преимущества:

- Оперативные поставки широкого спектра электронных компонентов отечественного и импортного производства напрямую от производителей и с крупнейших мировых складов;
- Поставка более 17-ти миллионов наименований электронных компонентов;
- Поставка сложных, дефицитных, либо снятых с производства позиций;
- Оперативные сроки поставки под заказ (от 5 рабочих дней);
- Экспресс доставка в любую точку России;
- Техническая поддержка проекта, помощь в подборе аналогов, поставка прототипов;
- Система менеджмента качества сертифицирована по Международному стандарту ISO 9001;
- Лицензия ФСБ на осуществление работ с использованием сведений, составляющих государственную тайну;
- Поставка специализированных компонентов (Xilinx, Altera, Analog Devices, Intersil, Interpoint, Microsemi, Aeroflex, Peregrine, Syfer, Eurofarad, Texas Instrument, Miteq, Cobham, E2V, MA-COM, Hittite, Mini-Circuits, General Dynamics и др.);

Помимо этого, одним из направлений компании «ЭлектроПласт» является направление «Источники питания». Мы предлагаем Вам помощь Конструкторского отдела:

- Подбор оптимального решения, техническое обоснование при выборе компонента;
- Подбор аналогов;
- Консультации по применению компонента;
- Поставка образцов и прототипов;
- Техническая поддержка проекта;
- Защита от снятия компонента с производства.



#### Как с нами связаться

**Телефон:** 8 (812) 309 58 32 (многоканальный)

**Факс:** 8 (812) 320-02-42

**Электронная почта:** [org@eplast1.ru](mailto:org@eplast1.ru)

**Адрес:** 198099, г. Санкт-Петербург, ул. Калинина, дом 2, корпус 4, литера А.