

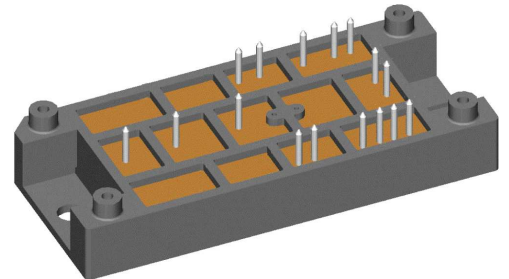
# Standard Rectifier Module

3~ Rectifier	Brake Chopper
$V_{RRM} = 1600 \text{ V}$	$V_{CES} = 1200 \text{ V}$
$I_{DAV} = 180 \text{ A}$	$I_{C25} = 250 \text{ A}$
$I_{FSM} = 1100 \text{ A}$	$V_{CE(sat)} = 1.7 \text{ V}$

## 3~ Rectifier Bridge + Brake Unit + NTC

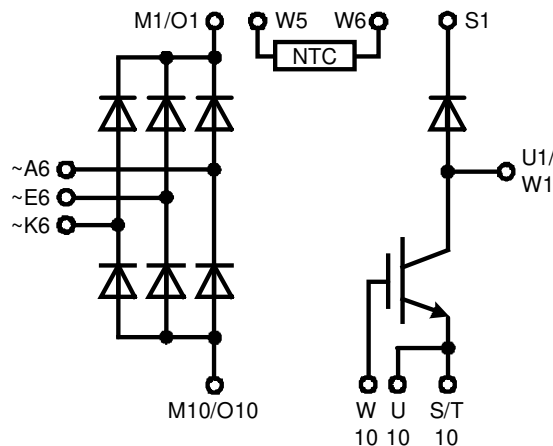
Part number

**VUB160-16NOXT**



Backside: isolated

 E72873



### Features / Advantages:

- Package with DCB ceramic base plate
- Improved temperature and power cycling
- Planar passivated chips
- Very low forward voltage drop
- Very low leakage current
- X2PT - 2nd generation Xtreme light Punch Through
- Rugged X2PT design results in:
  - short circuit rated for 10  $\mu\text{sec}$ .
  - very low gate charge
  - low EMI
  - square RBSOA @ 2x  $I_c$
- Thin wafer technology combined with X2PT design results in a competitive low  $V_{CE(sat)}$  and low thermal resistance

### Applications:

- 3~ Rectifier with brake unit for drive inverters

### Package: V2-Pack

- Isolation Voltage: 3600 V~
- Industry standard outline
- RoHS compliant
- Soldering pins for PCB mounting
- Height: 17 mm
- Base plate: DCB ceramic
- Reduced weight
- Advanced power cycling

### Disclaimer Notice

Information furnished is believed to be accurate and reliable. However, users should independently evaluate the suitability of and test each product selected for their own applications. Littelfuse products are not designed for, and may not be used in, all applications. Read complete Disclaimer Notice at [www.littelfuse.com/disclaimer-electronics](http://www.littelfuse.com/disclaimer-electronics).

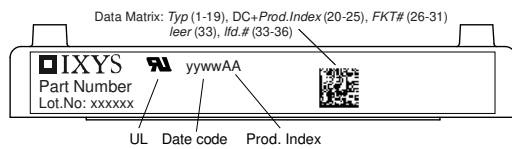
Rectifier				Ratings			
Symbol	Definition	Conditions		min.	typ.	max.	Unit
$V_{RSM}$	max. non-repetitive reverse blocking voltage					1700	V
$V_{RRM}$	max. repetitive reverse blocking voltage					1600	V
$I_R$	reverse current	$V_R = 1600$ V		$T_{VJ} = 25^\circ\text{C}$		100	$\mu\text{A}$
		$V_R = 1600$ V		$T_{VJ} = 125^\circ\text{C}$		2	mA
$V_F$	forward voltage drop	$I_F = 60$ A		$T_{VJ} = 25^\circ\text{C}$		1.16	V
		$I_F = 180$ A				1.55	V
		$I_F = 60$ A		$T_{VJ} = 125^\circ\text{C}$		1.09	V
		$I_F = 180$ A				1.59	V
$I_{DAV}$	bridge output current	$T_C = 90^\circ\text{C}$	rectangular	$T_{VJ} = 150^\circ\text{C}$		180	A
$V_{FO}$	threshold voltage	} for power loss calculation only		$T_{VJ} = 150^\circ\text{C}$		0.81	V
$r_F$	slope resistance					4.4	m $\Omega$
$R_{thJC}$	thermal resistance junction to case					0.6	K/W
$R_{thCH}$	thermal resistance case to heatsink				0.2		K/W
$P_{tot}$	total power dissipation			$T_C = 25^\circ\text{C}$		205	W
$I_{FSM}$	max. forward surge current	$t = 10$ ms; (50 Hz), sine		$T_{VJ} = 45^\circ\text{C}$		1.10	kA
		$t = 8,3$ ms; (60 Hz), sine		$V_R = 0$ V		1.19	kA
		$t = 10$ ms; (50 Hz), sine		$T_{VJ} = 150^\circ\text{C}$		935	A
		$t = 8,3$ ms; (60 Hz), sine		$V_R = 0$ V		1.01	kA
$I^2t$	value for fusing	$t = 10$ ms; (50 Hz), sine		$T_{VJ} = 45^\circ\text{C}$		6.05	kA <sup>2</sup> s
		$t = 8,3$ ms; (60 Hz), sine		$V_R = 0$ V		5.89	kA <sup>2</sup> s
		$t = 10$ ms; (50 Hz), sine		$T_{VJ} = 150^\circ\text{C}$		4.37	kA <sup>2</sup> s
		$t = 8,3$ ms; (60 Hz), sine		$V_R = 0$ V		4.25	kA <sup>2</sup> s
$C_J$	junction capacitance	$V_R = 400$ V; $f = 1$ MHz		$T_{VJ} = 25^\circ\text{C}$		37	pF



Brake IGBT + Diode				Ratings					
Symbol	Definition	Conditions	min.	typ.	max.	Unit			
$V_{CES}$	collector emitter voltage	$T_{VJ} = 25^{\circ}C$			1200	V			
$V_{GES}$	max. DC gate voltage				$\pm 20$	V			
$V_{GEM}$	max. transient gate emitter voltage				$\pm 30$	V			
$I_{C25}$	collector current	$T_C = 25^{\circ}C$			250	A			
$I_{C80}$		$T_C = 80^{\circ}C$			175	A			
$P_{tot}$	total power dissipation	$T_C = 25^{\circ}C$			695	W			
$V_{CE(sat)}$	collector emitter saturation voltage	$I_C = 150\text{ A}; V_{GE} = 15\text{ V}$			1.7	V			
					1.9	V			
$V_{GE(th)}$	gate emitter threshold voltage	$I_C = 6\text{ mA}; V_{GE} = V_{CE}$	6	6.8	7.5	V			
$I_{CES}$	collector emitter leakage current	$V_{CE} = V_{CES}; V_{GE} = 0\text{ V}$			0.1	mA			
					0.1	mA			
$I_{GES}$	gate emitter leakage current	$V_{GE} = \pm 20\text{ V}$			500	nA			
$Q_{G(on)}$	total gate charge	$V_{CE} = 600\text{ V}; V_{GE} = 15\text{ V}; I_C = 150\text{ A}$		510		nC			
$t_{d(on)}$	turn-on delay time	inductive load $V_{CE} = 600\text{ V}; I_C = 150\text{ A}$ $V_{GE} = \pm 15\text{ V}; R_G = 1.2\ \Omega$							
$t_r$	current rise time						$T_{VJ} = 125^{\circ}C$	220	ns
$t_{d(off)}$	turn-off delay time						100	ns	
$t_f$	current fall time						400	ns	
$E_{on}$	turn-on energy per pulse						220	mJ	
$E_{off}$	turn-off energy per pulse						21.5	mJ	
					17	mJ			
<b>RBSOA</b>	reverse bias safe operating area	$V_{GE} = \pm 15\text{ V}; R_G = 1.2\ \Omega$							
$I_{CM}$		$V_{CEK} = 1200\text{ V}$			450	A			
<b>SCSOA</b>	short circuit safe operating area	$V_{CEK} = 1200\text{ V}$							
$t_{SC}$	short circuit duration	$V_{CE} = 900\text{ V}; V_{GE} = \pm 15$			10	$\mu s$			
$I_{SC}$	short circuit current	$R_G = 1.2\ \Omega$ ; non-repetitive		650		A			
$R_{thJC}$	thermal resistance junction to case				0.16	K/W			
$R_{thCH}$	thermal resistance case to heatsink				0.10	K/W			
<b>Brake Diode</b>									
$V_{RRM}$	max. repetitive reverse voltage	$T_{VJ} = 25^{\circ}C$			1200	V			
$I_{F25}$	forward current	$T_C = 25^{\circ}C$			48	A			
$I_{F80}$		$T_C = 80^{\circ}C$			32	A			
$V_F$	forward voltage	$I_F = 30\text{ A}$			2.75	V			
					1.60	V			
$I_R$	reverse current	$V_R = V_{RRM}$			0.25	mA			
					1	mA			
$Q_{rr}$	reverse recovery charge	$V_R = 600\text{ V}$ $-di_F/dt = 900\text{ A}/\mu s$ $I_F = 30\text{ A}; V_{GE} = 0\text{ V}$							
$I_{RM}$	max. reverse recovery current						$T_{VJ} = 125^{\circ}C$	6	$\mu C$
$t_{rr}$	reverse recovery time						50	A	
$E_{rec}$	reverse recovery energy						350	ns	
					2	mJ			
$R_{thJC}$	thermal resistance junction to case				0.9	K/W			
$R_{thCH}$	thermal resistance case to heatsink				0.3	K/W			



Package V2-Pack		Ratings				
Symbol	Definition	Conditions	min.	typ.	max.	Unit
$I_{RMS}$	RMS current	per terminal			100	A
$T_{VJ}$	virtual junction temperature		-40		150	°C
$T_{op}$	operation temperature		-40		125	°C
$T_{stg}$	storage temperature		-40		125	°C
<b>Weight</b>				76		g
$M_D$	mounting torque		2		2.5	Nm
$d_{Spp/App}$	creepage distance on surface / striking distance through air	terminal to terminal	6.0			mm
$d_{Spb/Apb}$		terminal to backside	12.0			mm
$V_{ISOL}$	isolation voltage	t = 1 second 50/60 Hz, RMS; $I_{ISOL} \leq 1$ mA	3600			V
		t = 1 minute	3000			V



Ordering	Ordering Number	Marking on Product	Delivery Mode	Quantity	Code No.
Standard	VUB160-16NOXT	VUB160-16NOXT	Box	6	521692

Similar Part	Package	Voltage class
VUB160-16NOX	V2-Pack	1600

**Temperature Sensor NTC**

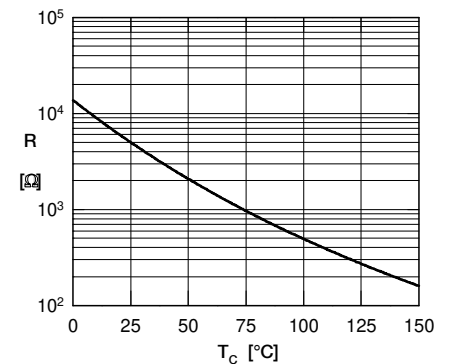
Symbol	Definition	Conditions	min.	typ.	max.	Unit
$R_{25}$	resistance	$T_{VJ} = 25^\circ$	4.75	5	5.25	k $\Omega$
$B_{25/50}$	temperature coefficient			3375		K

**Equivalent Circuits for Simulation**

\* on die level

$T_{VJ} = 150^\circ\text{C}$

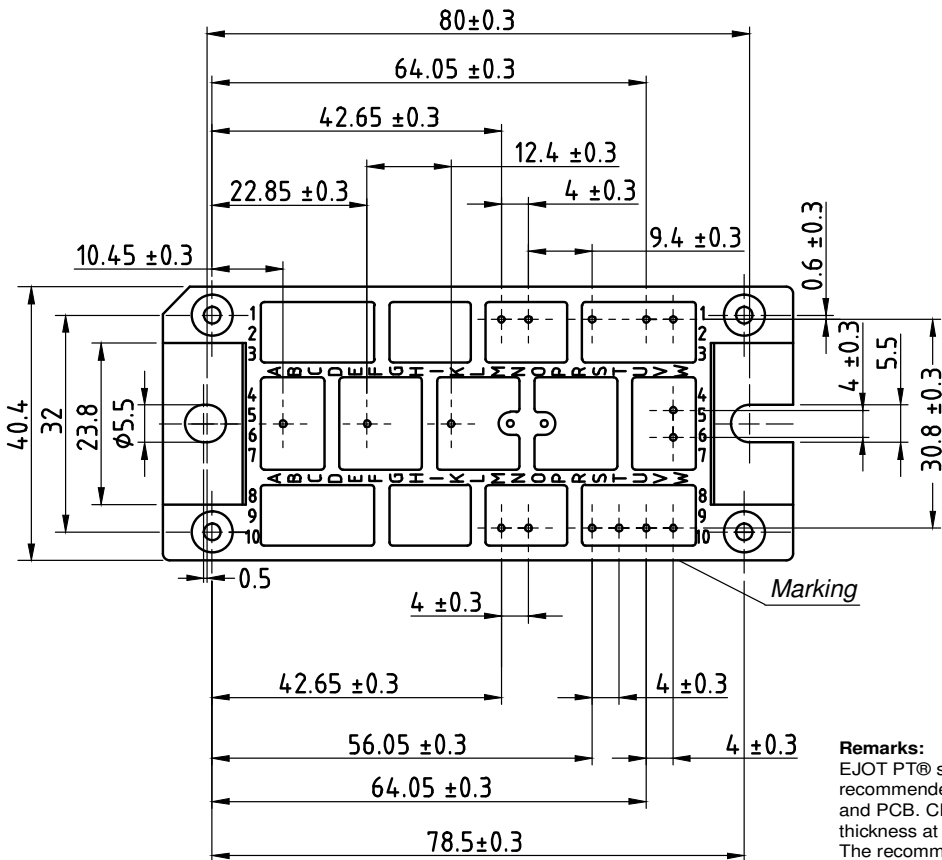
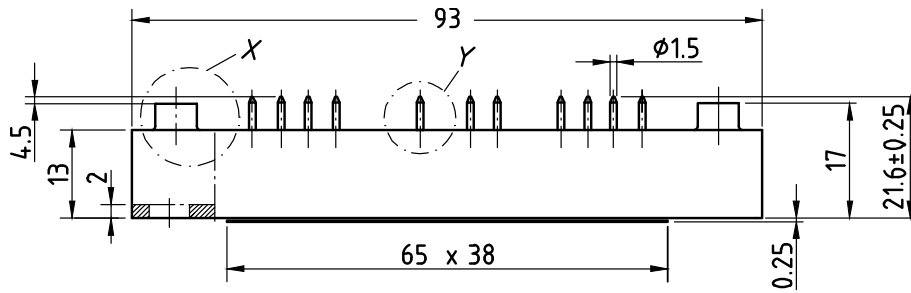
	Rectifier	Brake IGBT +	Brake Diode	
$V_{0\max}$	threshold voltage	0.81	1.1	1.31 V
$R_{0\max}$	slope resistance *	3.2	13.8	8 m $\Omega$



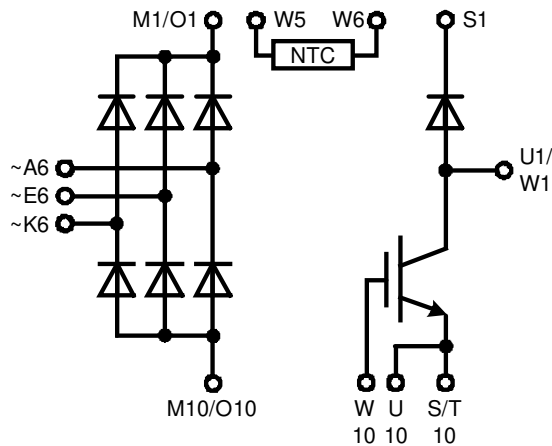
Typ. NTC resistance vs. temperature



**Outlines V2-Pack**



**Remarks:**  
EJOT PT® self-tapping screws of the dimension K25 are recommended for the mechanical connection between module and PCB. Choose the right length according to your board thickness at a maximum depth of 6 mm of the module holes. <sup>L</sup>  
The recommended mounting torque is 1.5 Nm.



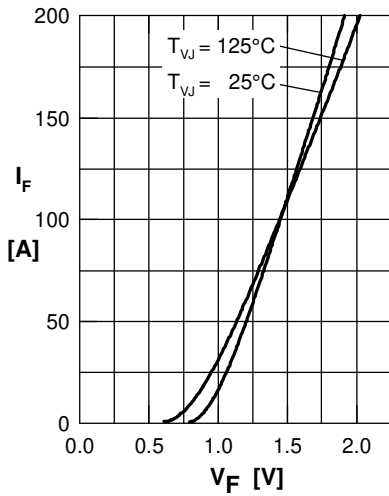
**Rectifier**


Fig. 1 Forward current vs. voltage drop per diode

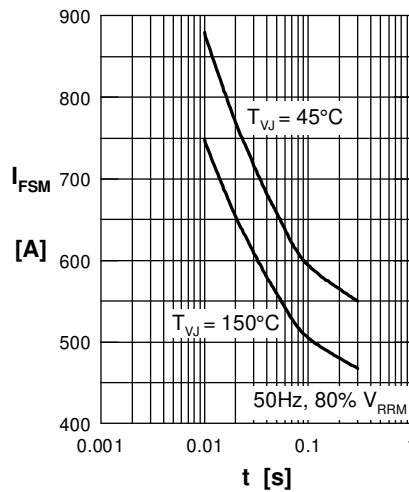


Fig. 2 Surge overload current vs. time per diode

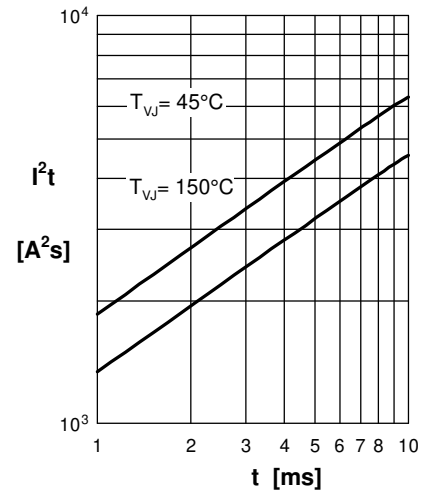
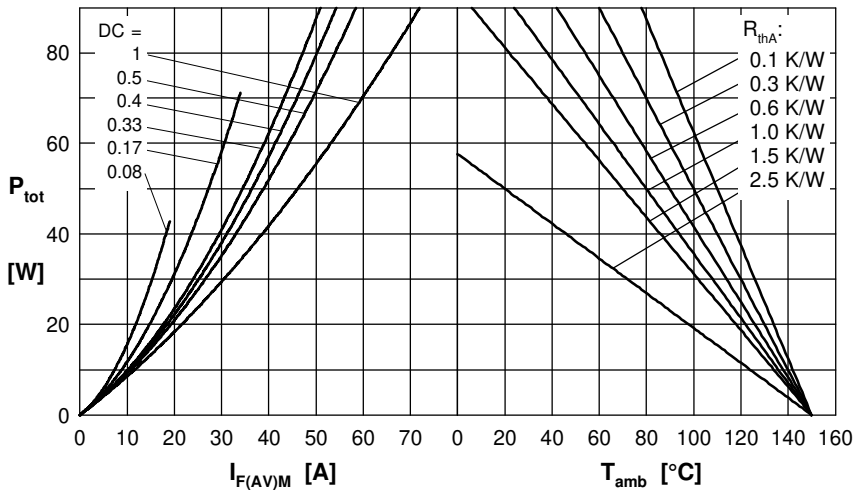

 Fig. 3  $I^2t$  vs. time per diode


Fig. 4 Power dissipation vs. forward current and ambient temperature per diode

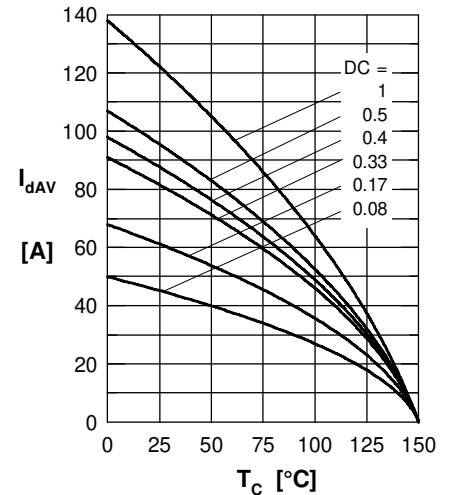


Fig. 5 Max. forward current vs. case temperature per diode

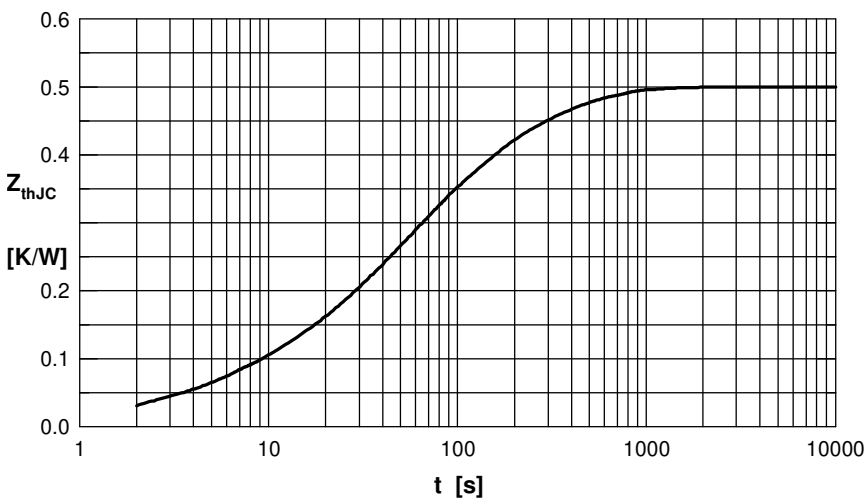


Fig. 6 Transient thermal impedance junction to case vs. time per diode

 Constants for  $Z_{thJC}$  calculation:

i	$R_{th}$ (K/W)	$t_i$ (s)
1	0.040	0.004
2	0.003	0.010
3	0.140	0.030
4	0.120	0.300
5	0.197	0.080

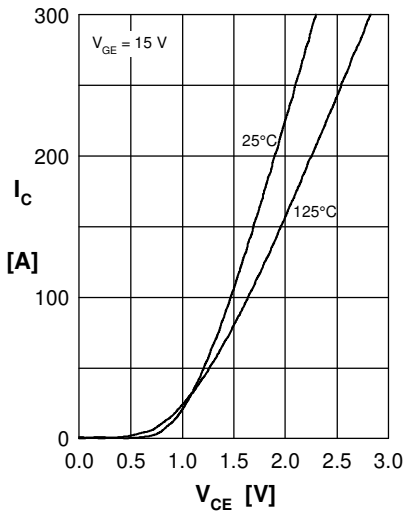
**Brake IGBT + Diode**


Fig.1 Output characteristics IGBT

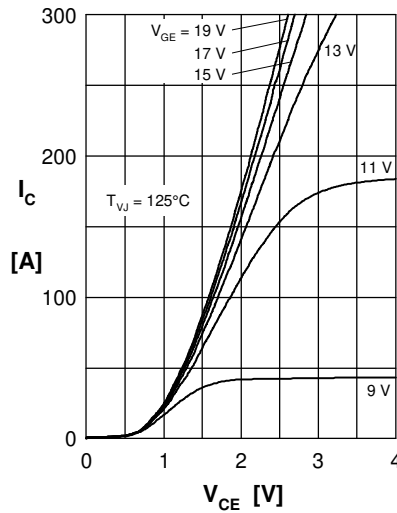


Fig.2 Typ. output characteristics IGBT

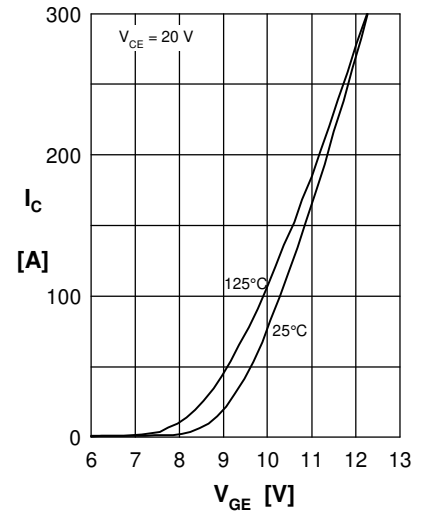


Fig.3 Typ. transfer charact. IGBT

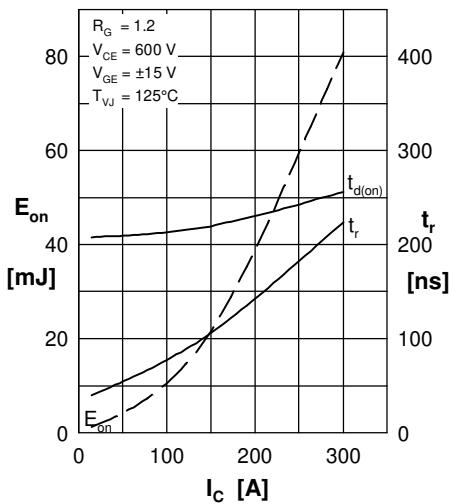


Fig.4 Typ. turn-on energy &amp; switch. times vs. collector current

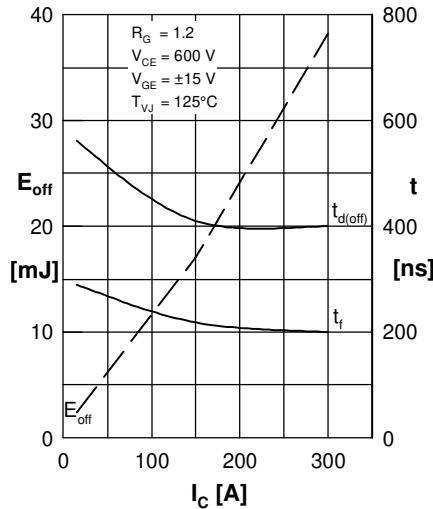


Fig.5 Typ. turn-off energy &amp; switch. times vs. collector current

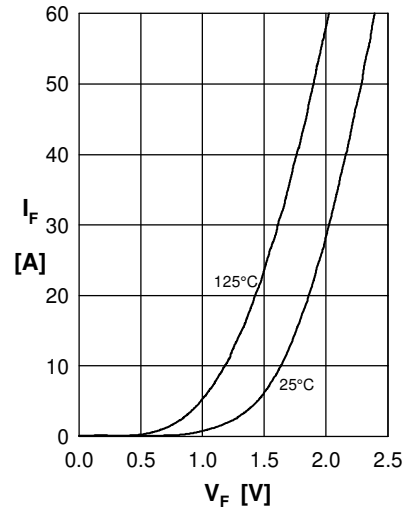


Fig.6 Typ. forward characteristics Diode

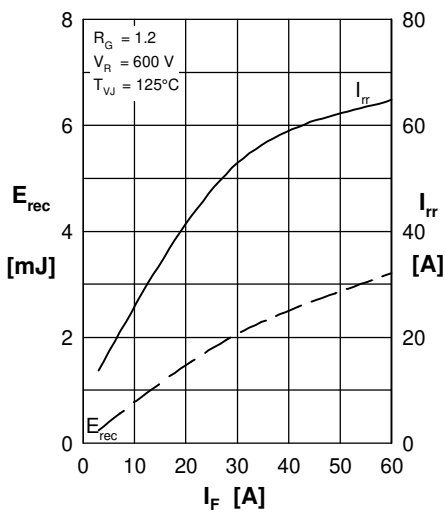


Fig.7 Typ. reverse recovery characteristics Diode

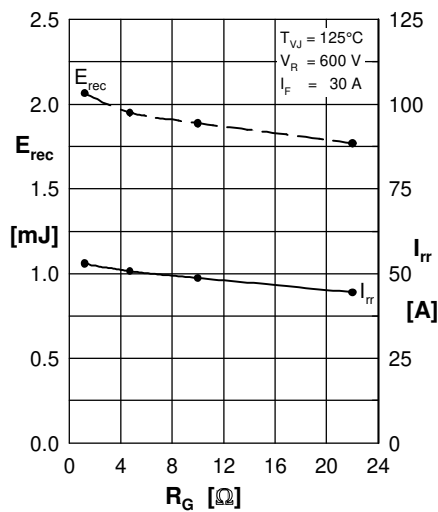


Fig.8 Typ. reverse recovery characteristics Diode

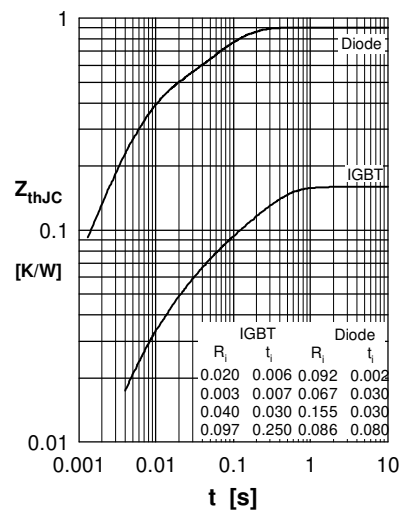


Fig.9 Transient thermal resistance junction to case



Компания «ЭлектроПласт» предлагает заключение долгосрочных отношений при поставках импортных электронных компонентов на взаимовыгодных условиях!

Наши преимущества:

- Оперативные поставки широкого спектра электронных компонентов отечественного и импортного производства напрямую от производителей и с крупнейших мировых складов;
- Поставка более 17-ти миллионов наименований электронных компонентов;
- Поставка сложных, дефицитных, либо снятых с производства позиций;
- Оперативные сроки поставки под заказ (от 5 рабочих дней);
- Экспресс доставка в любую точку России;
- Техническая поддержка проекта, помощь в подборе аналогов, поставка прототипов;
- Система менеджмента качества сертифицирована по Международному стандарту ISO 9001;
- Лицензия ФСБ на осуществление работ с использованием сведений, составляющих государственную тайну;
- Поставка специализированных компонентов (Xilinx, Altera, Analog Devices, Intersil, Interpoint, Microsemi, Aeroflex, Peregrine, Syfer, Eurofarad, Texas Instrument, Miteq, Cobham, E2V, MA-COM, Hittite, Mini-Circuits, General Dynamics и др.);

Помимо этого, одним из направлений компании «ЭлектроПласт» является направление «Источники питания». Мы предлагаем Вам помощь Конструкторского отдела:

- Подбор оптимального решения, техническое обоснование при выборе компонента;
- Подбор аналогов;
- Консультации по применению компонента;
- Поставка образцов и прототипов;
- Техническая поддержка проекта;
- Защита от снятия компонента с производства.



#### Как с нами связаться

**Телефон:** 8 (812) 309 58 32 (многоканальный)

**Факс:** 8 (812) 320-02-42

**Электронная почта:** [org@eplast1.ru](mailto:org@eplast1.ru)

**Адрес:** 198099, г. Санкт-Петербург, ул. Калинина, дом 2, корпус 4, литера А.